



2024

PREISLISTE

Gültigkeit bis 28.02.2025

**Unverbindlich empfohlene Verkaufspreise exkl. gesetzlicher MwSt.
Preis und Druckfehler sowie technische Änderungen vorbehalten.**

BETA IST
ENTSCHLOSSENHEIT. ENGAGEMENT. HARMONIE. TALENT.



In Beta gibt es nur einen Weg zu arbeiten, nämlich den, gut zu arbeiten.

Das ist die Welt von Beta, das ist der Grundsatz, an dem sich weltweit unsere tägliche Arbeit orientiert, inspiriert von vier Werten:

ENTSCHLOSSENHEIT

in ein 1923 von einem italienischen Handwerker gegründetes, sich weltweit etabliertes und seit vier Generationen stetig wachsendes Unternehmen zu investieren und es immer wieder anzukurbeln.

ENGAGEMENT

die Qualität unserer Produkte bis ins kleinste Detail zu pflegen, damit jeder Händler weiß, dass er sich auf einen effizienten Service verlassen kann, und jeder Anwender auf die Präzision, Zuverlässigkeit und Langlebigkeit der Produkte von Beta.

HARMONIE

der Linien für ein hervorragendes Design, denn ist etwas gut gemacht, dann ist es Ausdruck eines perfekten Gleichgewichts zwischen Funktion und Design

TALENT

unsere wertvollste Ressource, die unsere Mitarbeiter und all jene auszeichnet, die sich für Beta entscheiden, um bei der leidenschaftlichen Verwirklichung ihrer Ideen und Träume nichts dem Zufall zu überlassen.

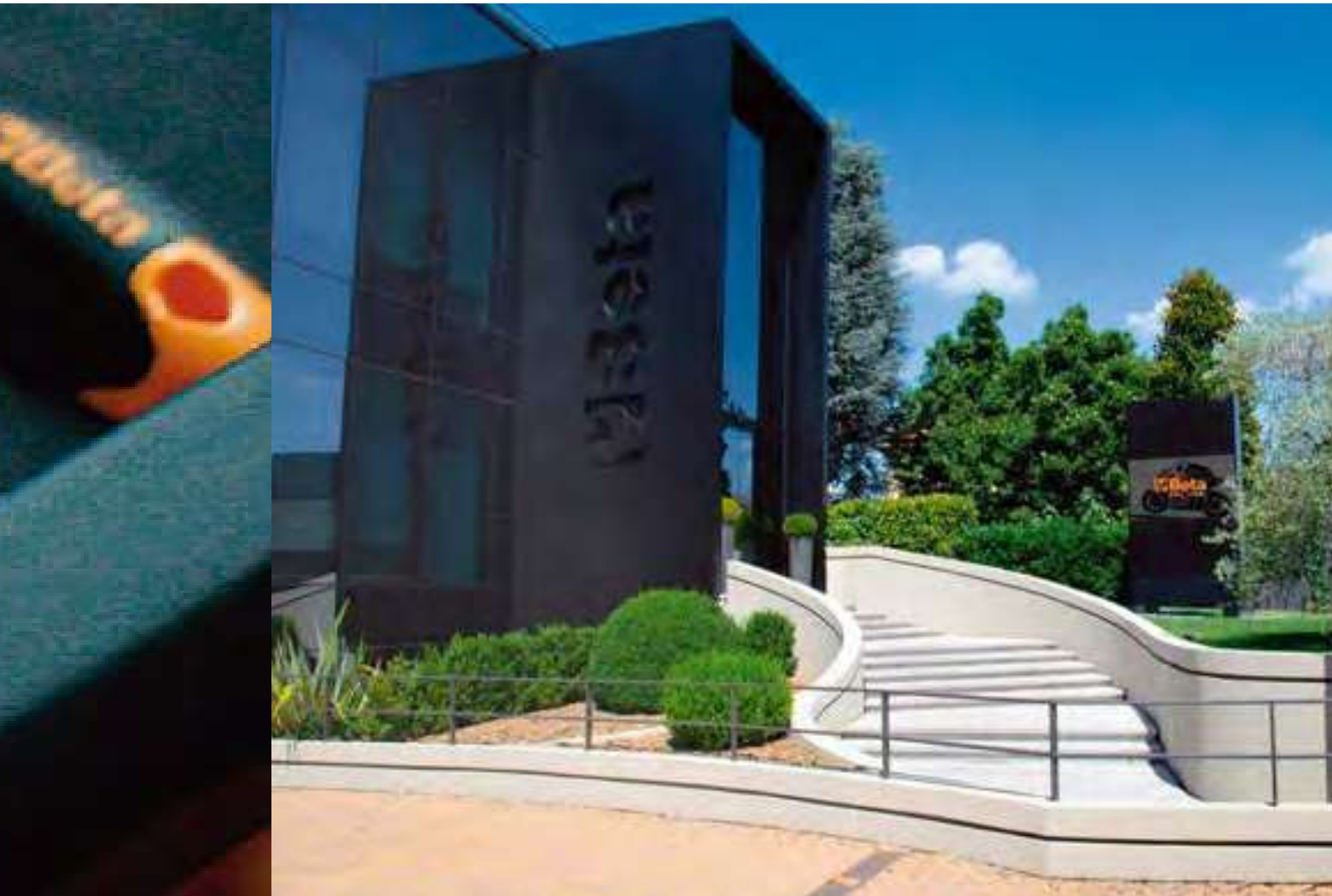

INDEX



Index.....	4
Leseführer	8
Einsatzbereiche Drehmomentschlüssel	58-59
Tabelle für Werkstattwagen und Sortimente.....	351, 479-480
Gestrichene artikel – ersatzartikel/empfohlene artikel.....	727÷729
Inhaltsverzeichnis	730÷734
Alphabetisches verzeichnis KFZ-spezialwerkzeuge.....	735÷737
Alphanumerischen Index	738÷753
Schlüsselzahlen Beta Group	754
Die Geschichtedes italienischen Werkzeugbaus	755
Zertifizierte Qualität	756
Kontrolle und Qualität	757
Logistik.....	758
Die arbeit organisieren	759
Effiziente präsent.....	760

INDEX

WERKSTATTEINRICHTUNG **RSC55**



RSC55

410÷435; 475÷478

WERKSTATTEINRICHTUNG **RSC50**



Beta
RSC50

436÷453; 475÷478

WERKSTATTEINRICHTUNG **C45PRO**



Beta
C45PRO

454÷478

WERKSTATTEINRICHTUNGEN UND SORTIMENTE



351÷370



371÷400



383; 401÷409

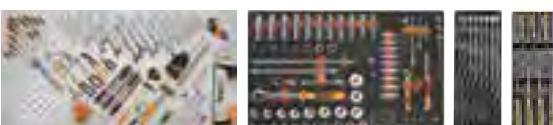

479÷561

SCHLÜSSEL



11÷17

23÷27

112÷117

STECKSCHLÜSSEL UND ZUBEHÖR



69÷78

85÷112

DREHMOMENTSCHLÜSSEL UND DREHMOMENTVERVIELFÄLTIGER



54÷56

57÷69

SCHRAUBENDREHER, STIFTSCHLÜSSEL UND SCHRAUBEINSÄTZE

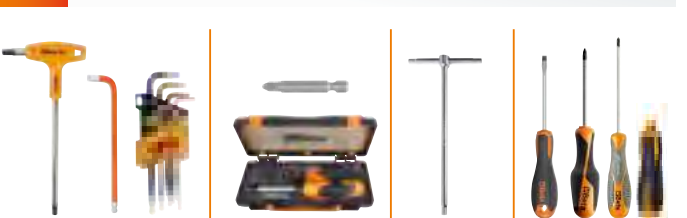

18÷23

78÷85

114÷117

145÷159

ZANGEN

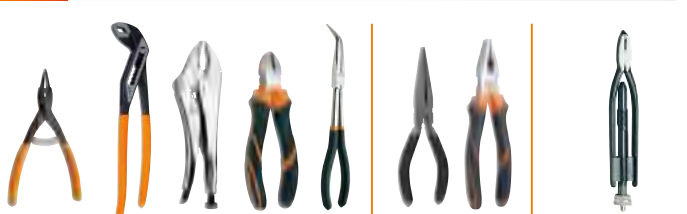

127÷134

139÷142

236

HÄMMER UND SCHLAGWERKZEUGE



9-10

166÷170

217÷218

LAMPEN



242÷247

BOHR- UND GEWINDE-SCHNEIDWERKZEUGE



36÷41

41÷43

44÷51

51÷53

ROLLEN



247÷249; 347

ABZIEHER

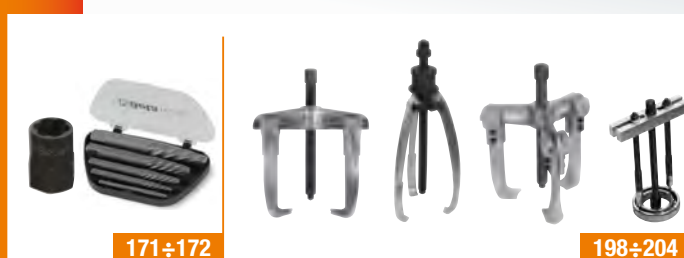

171÷172

198÷204

HYDRAULIK

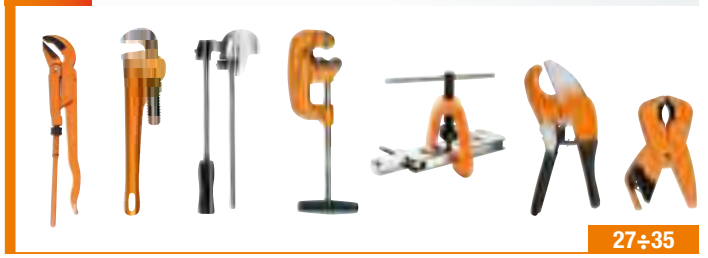

27÷35

MESS- UND ANREISSWERKZEUGE



210÷217

ELEKTRONIK UND MIKROMECHANIK



126-127

142÷144

148÷151

SCHNEIDWERKZEUGE UND WERKZEUGE FÜR DIVERSE ANWENDUNGEN



122÷123

134÷136

158÷159

184

ELEKTROTECHNIK



136÷139

150

585÷587

232÷236



209

219÷228

SCHWEISSWERKZEUGE



250÷254



238÷241

325÷326

1000V-ISOLIERTE WERKZEUGE

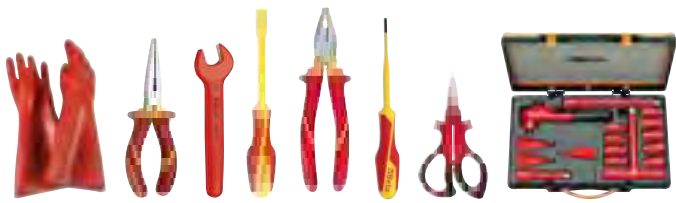

285÷291

WERKZEUGE AUS EDELSTAHL



299÷303

FUNKENFREIE WERKZEUGE



304÷312

KFZ-SPEZIAL



118÷125

160÷166



170÷198; 204÷208

229÷232

232÷238

WERKSTATT-AUSRÜSTUNG



254÷273

MOTORRAD-WERKZEUGE



274÷279

FAHRRAD-WERKZEUGE



280÷284

ELEKTRISCHE PRODUKTE



313÷324

DRUCKLUFTWERKZEUGE UND ZUBEHÖR



327÷350

WERKZEUG-RÜCKHALTESYSTEM



292÷298

BETA CHEMICALS



562÷567

SICHERHEITSSCHUHE (UND FUNKTIONSSOCKEN)



624÷649

BETA ABRASIVES



568÷584

ARBEITSBEKLEIDUNG



650÷670

PRODUKTE DER MARKE BM



588÷594

BLISTER-SORTIMENT

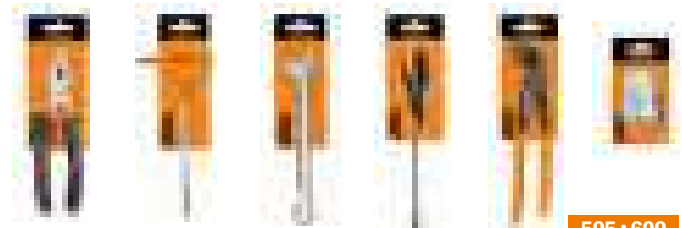

595÷609

ROBUR-SEILZUBEHÖR



671÷714

LÖSUNGEN FÜR DIE VERKAUFSSTELLE

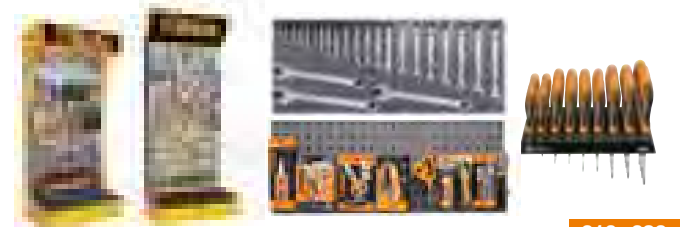

610÷623

BETA COLLECTION



715÷726

LESEFÜHRER

Artikelnummer

951GP

Stiftschlüssel mit T-Griff, Sechskantprofil an einem Ende

Der Stiftschlüssel Beta 951GP ermöglicht ein schnelles Manövrieren und präzises Ankoppeln an die Schraube. Entwickelt, um einige rennsportspezifische Problematiken zu lösen. Hohe Drehmomente ermöglichen ein schnelles Verschrauben.

Werkzeugprofil



Preis

- ★ auf Anfrage lieferbarer Artikel
- Hauptabmessung
- ◊ Sechskantmaul

Maß

Standard-Packung

Stück

Packungssymbol

Inhalt des Satzes

mm	L mm	L1 mm	Ø mm	€	3	009511530
3	185	130	5	22,00	3	009511530
4	214	150	5	23,00	3	009511540
5	240	165	6	26,00	3	009511550
6	271	180	7	30,00	3	009511560
8	300	200	10	39,00	3	009511580
10	310	200	12	48,00	3	009511610

951GP/S6	€	184,00	1	009511687
3-4-5-6-8-10 mm				

In Blister-Verpackung



Motorrad-Werkzeuge



Fahrrad-Werkzeuge



Nummer

Neue Artikel 2024

Aufschlüsselung der wichtigsten

Abkürzungen Beispiel

bei den Sätzen	
B	= in Kunststofftasche 42/B9
BV	= Tasche, leer 42/BV9
C	= im Blechkasten 900/C11
D	= in aufhängbarer Packung 1293/D6
S	= im Karton 42/S17
SP	= mit Ständer 42MEW/SP25
SPV	= Ständer, leer 42/SPV7
SC	= mit Kompakthalterung 96/SC9
SCV	= leere Kompakthalterung 96/SCV

bei den Sortimenten	
AS	= Schlüssel in Zollmaßen 5915VU/AS
E	= Elektronik/Elektrotechnik 5980ET/A
I	= Hydraulik 5980ID
MT	= Erdbewegungsmaschinen 5902MT
U	= Universal 5915VU/3
SBK	= Motorradreparatur 5940SBK
VG	= Kfz-Sektor 5904VG/5T
VI	= Industrie 5902VI

Sockets	
A	= 6kant-Profil 910A
B	= 12kant-Profil 910B
ES	= für Innenkeilprofilschrauben 920ES
FTX	= für TORX®-Schrauben 910FTX

Aufschlüsselung der wichtigsten

Abkürzungen Beispiel

PT	= für 5-spitzige Schrauben	910PT
X	= Umschaltknarre in den Kästen	920A/C12X

bei den Schraubendrehern und Schraubeinsätzen

LP	= für Schlitzschrauben	920LP
PE	= für 6kant-Schrauben	920PE
PH	= für PHILLIPS®-Schrauben	920PH
PZ	= für POZIDRIV®- und SUPADRIV®-Schrauben	1299PZ
RTX	= für TAMPER-RESISTANT-TORX®-Schrauben	1298RTX
SP	= für SPANNER Schrauben	861SP
TRW	= für TRI-WING®-Schrauben	861TRW
TQS	= für TORQ-SET®-Schrauben	861TQS
TX	= für TORX®-Schrauben	920TX
XZN	= für XZN®-Schrauben	920XZN

Allgemeines

AS	= Zollmaße	42AS
BA	= funkenfreie Werkzeuge	42BA
BM	= Griff aus Bimaterial	1150BM
C	= Metallbehälter, leer	C25
HS	= Werkzeug-Rückhaltesystem	42HS
INOX	= Werkzeuge aus Edelstahl	42 INOX
L	= Lange Ausführung	952L
MQ	= 1000V-isolierte Werkzeuge	1150MQ
MP	= Glanz-Finish	42MP
R	= Ersatzteil	338R

Die dargestellten Bilder dienen zur Orientierung.

Die Firma Beta Utensili behält sich das Recht vor, ihre Produktpalette ohne Vorankündigung anzupassen oder zu verbessern



Beta EMPFIEHLT die angemessene Anwendung der Werkzeuge und die Beachtung der persönlichen Schutzmaßnahmen.



SPLINTTREIBER

Die Schlagwerkzeuge Beta sind so ausgelegt, dass sie die besten Leistungen erzielen und dabei immer die höchste Sicherheit des Anwenders garantieren.

Für die Herstellung wird ein spezieller Stahl – Chrom-Molybdän-Vanadium-Stahl (65CrMoV2-2) verwendet, der sehr hohe Härten erzielt und gleichzeitig eine bemerkenswerte Zähigkeit bewahrt. Wo es die Geometrien erlauben, werden die Produkte ausgehend von einer drahtgezogenen Stange realisiert, in den anderen Fällen sind unter kontrollierter Atmosphäre warmgeschmiedet, um die Schlackenbildung zu vermeiden.

1 Die Sechskant-Profile verhindern das Rollen des Werkzeugs auf der Auflagefläche.

2 Die Splinttreiber haben zwar einen sehr langen, aber immer perfekt geradlinigen Schaft, um den Zugang auch in Situationen mit wenig Bewegungsfreiraum zu ermöglichen.

3 Um die korrekte Größe der Splinttreiber zu garantieren, führen wir das Anköpfen jedes einzelnen Stücks so aus, dass der zylinderförmige Teil gleichmäßig und das Ende perfekt flach ist, um eine höhere Wirksamkeit zu gewährleisten.

4 Alle Schlagaufsätze werden einem induktiven Anlassprozess unterzogen, um die Ausbreitung von Splintern auszuschließen; die Verformung der Schlagspitze ist eine natürliche Konsequenz, um die Sicherheit des Anwenders zu gewährleisten.

5 Das Schleifen und Anschärfen von Körnern und Meißeln erfolgt nach der Verchromungsbehandlung, um ein höheres Einstich- und Schneidvermögen zu erzielen, aber auch um die galvanische Ablagerung an der Spitze zu entfernen, die in der Regel die Kanten "abrundet" und so das Produkt aufgrund des während der Galvanisierung erzeugten Wasserstoffs das Produkt gebrechlich macht. Die bearbeiteten Zonen sind mit einem Rostschutzfilm überzogen.



30 Durchschläger



Ø mm	L mm	€	Hand	Computer
2	125	8,50	10	000300020
3	125	8,50	10	000300030
4	150	11,40	10	000300040
5	150	11,40	10	000300050
6	150	11,90	10	000300060

31 Splinttreiber



Ø mm	L mm	L1 mm	€	Hand	Computer
2	110	22	8,50	10	000310002
3	128	35	8,80	10	000310003
4	146	45	10,80	10	000310004
5	164	55	11,40	10	000310005
6	182	65	14,20	5	000310006
8	200	80	15,00	5	000310008
10	220	95	18,80	5	000310010

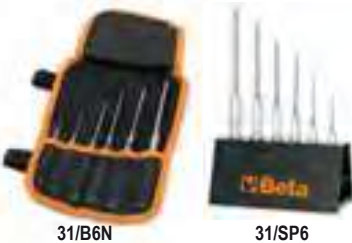

Model	€	Hand	Computer
31/B6N 2-3-4-5-6-8 mm	78,00	1	000310024
2002/BV6	10,50	1	020020000
31/SP6 2-3-4-5-6-8 mm	93,00	1	000310030
31/SPV	23,50	1	000310031

31BM Splinttreiber mit Griff



Ø mm	L mm	L1 mm	€	Hand	Computer
2	168	42	17,40	2	000310402
3	180	52	17,80	2	000310403
4	191	62	19,50	2	000310404
5	200	72	20,50	2	000310405
6	221	82	23,50	2	000310406
8	235	94	24,70	2	000310408



Model	€	Hand	Computer
31BM/D6 2-3-4-5-6-8 mm	123,00	1	000310420

31L Splinttreiber, lang



Ø mm	L mm	L1 mm	€	Hand	Computer
4	175	80	12,80	5	000310104
5	175	80	13,70	5	000310105
6	175	80	16,10	5	000310106

31SE Splinttreiber mit Führungsspitze



Ø mm	D mm	L mm	L1 mm	€	Hand	Computer
4	2,4	175	80	12,80	5	000310204
5	3,0	175	80	13,70	5	000310205
6	3,6	175	80	16,10	5	000310206



Model	€	Hand	Computer
31/B6N-LSE 31L: 4-5-6 mm 31SE: 4-5-6 mm	94,50	1	000310324
2002/BV6	10,50	1	020020000

32 Körner



Ø mm	L mm	L1 mm	€	Hand	Computer
3	100	44	7,90	10	000320100
4	125	52	9,80	10	000320125
5	150	62	11,80	10	000320150

32AU Automatischer Körner



Ø mm	L mm	L1 mm	€	Hand	Computer
3	150	23	63,50	2	000320160

32AUR

Ersatzspitze für Art. 32AU



Ø mm	€	U	L
3	11,50	5	000320170

33LT

Prägestempel mit Buchstaben

- Für das Prägen aus Stahl mit einer Festigkeit R von bis zu 80 kg/mm²
- Satz bestehend aus 27 Prägestempeln: Buchstaben von A bis Z + &



H mm	L mm	A mm	€	U	L
3	60	6,35	72,00	1	000330023
4	63	7,93	88,00	1	000330024
5	61	7,93	88,00	1	000330025
6	68	9,52	108,00	1	000330026
8	70	12,7	161,00	1	000330028

33NR

Prägestempel mit Zahlen

- Für das Prägen auf Stahl mit einer Festigkeit R von bis zu 80 kg/mm²
- Satz bestehend aus 9 Prägestempeln: Zahlen von 0 bis 9



H mm	L mm	A mm	€	U	L
3	61	6,35	26,00	1	000330003
4	62	7,93	31,00	1	000330004
5	62	7,93	31,00	1	000330005
6	68	9,52	38,00	1	000330006
8	71	12,7	55,00	1	000330008

34

Flachmeißel, Standardausführung



L mm	A mm	L1 mm	€	U	L
125	14,5	45	12,30	5	000340001
150	17,0	58	16,00	5	000340002
175	21,5	68	23,20	5	000340003

35

Flachmeißel, mit Hohlprofil



L mm	A mm	€	U	L
100	14,5	14,30	5	000350001
125	17,0	16,00	5	000350002
150	20,5	19,90	5	000350003
200	23,0	30,00	5	000350004
250	28,5	43,50	2	000350005
300	34,0	59,00	2	000350006

35PM

Flachmeißel, mit Hohlprofil mit Handschutz

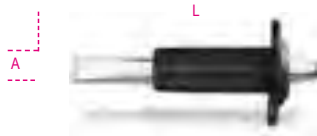

L mm	A mm	€	U	L
200	23,0	45,50	2	000350014
250	28,5	58,00	2	000350015
300	34,0	74,50	2	000350016

35PMR

Ersatzhandschutz für Art. 35PM



L mm	€	U	L
200	15,00	1	000350024
250	15,00	1	000350025
300	15,80	1	000350026

36

Kreuzmeißel, Standardausführung



L mm	A mm	L1 mm	€	U	L
125	4	44	12,80	5	000360001
150	6	53	15,00	5	000360002

37

Kreuzmeißel, mit Hohlprofil



L mm	A mm	L1 mm	€	U	L
150	6	45	22,90	5	000370001
200	8	55	33,00	3	000370002

37PM

Kreuzmeißel, mit Hohlprofil mit Handschutz



L mm	A mm	€	U	L
200	8	48,50	2	000370012

37PMR

Ersatzhandschutz für Art. 37PM



L mm	€	U	L
200	15,80	1	000370022



38/B6N



38/SP6

€	U	L
80,00	1	000380016
38/B6N		
30: 2-3 mm		
32: 4 mm		
34: 125-150 mm		
36: 150 mm		
2002/BV6	10,50	1 020020000
38/SP6	94,50	1 000380009
30: 2-3 mm		
32: 4 mm		
34: 125-150 mm		
36: 150 mm		
38/SPV	27,00	1 000380019



42 RING-MAULSCHLÜSSEL

Der kultige Ring-Maulschlüssel von Beta.

Eine elegante und schlanke Form, sanfter in den Linien und leichter in der Hand. Die Kraft, Beständigkeit und Ergonomie des Beta Schlüssels erreichen noch höhere Werte, um den Benutzern den bestmöglichen Schlüssel in ihren Händen anzubieten. Der Herstellungsprozess findet in unseren Werken in Sovico und Sulmona statt und bedient sich der fortschrittlichsten Technologien hinsichtlich Automation und der erfahrensten Techniker.

SCHNELLIGKEIT

15° Winkel im Vergleich zur Achse, um den Rückschwenkwinkel zu reduzieren.

WIDERSTANDSKRAFT

Große Widerstandskraft: Bei unsachgemäßem Gebrauch verformt sich der Schlüssel und bricht nicht plötzlich und auf gefährliche Weise.

HOMOGENITÄT

Das Formpressverfahren beginnt von einem Halbfabrikat mit rundem Querschnitt, was eine gleichmäßige Verteilung der Fasern garantiert und die Bildung von gefährlichen internen Spannungen vermeidet.

ZUGÄNGLICHKEIT

Reduzierte Dicken für eine bessere Zugänglichkeit.

SCHUTZ

Die Nickel-Chrombeschichtung garantiert auf Dauer den Schutz gegen äußere Einflüsse und besteht die schwierigen Adhäsionsprüfungen der Norm ISO 2819.

LEISTUNG

Mehr als doppelt so hohe Drehmomentwerte im Vergleich zu den Anforderungen der Norm ISO 1711.

OPTIMIERUNG

Die Länge des Schlüssels, die höher als die der meisten der Konkurrenten ist, ermöglicht hohe Drehmomente mit weniger Anstrengung.



ERGONOMIE

Das vieleckige Ringauge ist um 15° geneigt, um die Hand zu schützen. Die Form wird durch Pressen erreicht, nicht danach verbogen.



42

Ring-Maulschlüssel

Doppelt so hohe Drehmomentwerte im Vergleich zu den Anforderungen der Norm ISO 1711

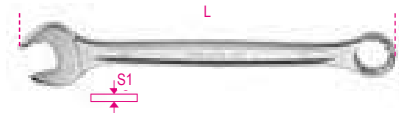

DIN 3113 UNI-ISO 7738

mm	L mm	S1 mm	€	Icon	Icon
5,5x5,5	95	3,4	9,10	5	000421005
6x6	95	3,4	9,20	5	000421006
7x7	105	3,6	9,30	5	000421007
8x8	116	3,9	9,50	5	000421008
9x9	127	4,2	10,00	5	000421009
10x10	137	4,5	10,30	5	000421010
11x11	148	4,8	11,00	5	000421011
12x12	158	5,1	11,20	5	000421012
13x13	169	5,6	11,20	5	000421013
14x14	180	5,7	12,90	5	000421014
15x15	190	6,0	14,20	5	000421015
16x16	201	6,3	14,70	5	000421016
17x17	212	6,8	15,50	5	000421017
18x18	222	7,0	16,40	5	000421018
19x19	233	7,5	16,90	5	000421019
20x20	243	7,7	19,00	3	000421020
21x21	254	7,9	20,40	3	000421021
22x22	264	8,3	21,10	3	000421022
23x23	275	8,5	22,70	3	000421023
24x24	285	8,7	23,90	3	000421024
25x25	296	8,7	25,50	2	000421025
26x26	307	8,9	27,50	2	000421026
27x27	317	9,1	29,50	2	000421027
28x28	328	9,3	30,50	2	000421028
29x29	338	9,5	33,50	2	000421029
30x30	349	9,7	34,50	2	000421030
32x32	370	10,1	38,00	2	000421032
34x34	391	10,5	72,50	1	000421034
35x35	412	10,7	78,00	1	000421035
36x36	412	10,7	81,50	1	000421036
38x38	433	11,3	90,00	1	000421038
41x41	465	12,0	100,00	1	000421041



€	Icon	Icon
42/B9N	118,00	1 000421074
6-7-8-10-11-13-14-17-19 mm		
2002/BV9	13,40	1 020020030



ACHTUNG!

Die Form des Ring-Maulschlüssels 42 ist mit allen Behältern und Modulen des historischen Ring-Maulschlüssels 42 kompatibel



42/S14	€	🔧	📦
6-7-8-10-11-12-13-14 -15-16-17-19-22-24 mm	190,00	1	000421067
42/S17	231,50	1	000421065
6-7-8-9-10-11-12-13-14-15 16-17-18-19-20-21-22 mm			
42/S15	263,00	1	000421066
6-7-8-10-11-12-13-14 17-19-22-24-27-30-32 mm			
42/S17X	275,00	1	000421068
6-7-8-10-11-12-13-14- 15-16-17-19-21-22- 24-27-30 mm			
42/S26	497,00	1	000421070
6-7-8-9-10-11-12-13-14 15-16-17-18-19-20-21 22-23-24-25-26-27-28 29-30-32 mm			

42/SC9I-E

Ring-Maulschlüssel, 9-teilig, mit kompakter Halterung

Doppelt so hohe Drehmomentwerte im Vergleich zu den Anforderungen der Norm ISO 1711



42/SC9I	€	🔧	📦
8-10-11-12-13-14-15-17-19 mm	122,00	1	000421087
142/SCV9I	11,80	1	001420103
42/SC9E	125,50	1	000421088
8-10-11-12-13-16-17-18-19 mm			
142/SCV9E	11,80	1	001420104



42/SP25	€	🔧	📦
6-7-8-9-10-11-12-13-14 15-16-17-18-19-20-21 22-23-24-25-26-27-28 30-32 mm	534,00	1	000421085
42/SPV2	70,50	1	000420090



42/SP15

42/SPV...

42/SP15	€	🔧	📦
6-7-8-9-10-11-12-13-14-15 16-17-19-22-24 mm	207,00	1	000421078
42/SPV7	8,40	1	000420097
42: 8-10-11-13-14-17-19 mm 55: 6x7-8x9-10x11-12x13 14x15-16x17-18x19 mm			
42/SPV11	11,80	1	000420100
42MP: 8-9-10-11-12-13 14-15-16-17-19 mm 142-142SN: 8-9-10-11-12-13 14-15-16-17-19 mm			
42/SPV15	15,90	1	000420102
42: 6-7-8-9-10-11-12-13-14 15-16-17-19-22-24 mm			

42AS

Ring-Maulschlüssel



🔧	L mm	€	🔧	📦
1/4x1/4	95	11,30	2	000420106
9/32x9/32	106	11,50	2	000420107
5/16x5/16	116	11,60	2	000420108
3/8x3/8	137	12,80	2	000420110
7/16x7/16	148	13,70	2	000420111
1/2x1/2	169	14,10	2	000420113
9/16x9/16	180	15,40	2	000420114
19/32x19/32	191	16,80	2	000420115
5/8x5/8	201	17,80	2	000420116
11/16x11/16	212	19,00	2	000420117
3/4x3/4	233	20,30	2	000420119
13/16x13/16	254	24,50	2	000420121
7/8x7/8	264	25,50	2	000420122
15/16x15/16	285	29,50	2	000420124
1x1	296	30,00	2	000420125
1.1/16x1.1/16	317	34,50	2	000420127
1.1/8x1.1/8	338	37,50	2	000420129
1.1/4x1.1/4	370	46,00	2	000420132
1.5/16x1.5/16	391	75,00	1	000420133
1.3/8x1.3/8	412	86,00	1	000420135
1.7/16x1.7/16	412	89,00	1	000420136
1.1/2x1.1/2	433	93,50	1	000420138



42AS/B9N	€	🔧	📦
1/4-5/16-3/8-7/16-1/2	148,50	1	000420159
9/16-5/8-11/16-3/4			
2002/BV9	13,40	1	020020030



42AS/13	€	🔧	📦
1/4-5/16-3/8-7/16-1/2-9/16-5/8 11/16-3/4-13/16-7/8-15/16-1	245,00	1	000420163
42AS/16	363,00	1	000420166
1/4-5/16-3/8-7/16-1/2-9/16-5/8 11/16-3/4-13/16-7/8-15/16-1- 1.1/16-1.1/8-1.1/4			
42AS/17	345,00	1	000420168
1/4-9/32-5/16-3/8-7/16-1/2- 9/16-19/32-5/8-11/16-3/4- 13/16-7/8-15/16-1-1.1/16-1.1/8			

42MP

Ring-Maulschlüssel, poliert



DIN 3113 UNI-ISO 7738

🔧	L mm	€	🔧	📦
6x6	95	15,50	5	000420606
7x7	105	15,60	5	000420607
8x8	116	15,70	5	000420608
9x9	127	15,80	5	000420609
10x10	137	15,90	5	000420610
11x11	148	16,30	5	000420611
12x12	158	16,40	5	000420612
13x13	169	16,60	5	000420613
14x14	180	17,90	5	000420614
15x15	190	19,40	5	000420615
16x16	201	20,50	5	000420616
17x17	212	21,40	5	000420617
18x18	222	22,90	5	000420618
19x19	233	23,60	5	000420619
20x20	243	27,00	3	000420620
21x21	254	28,50	3	000420621
22x22	264	29,00	3	000420622
24x24	285	33,50	3	000420624
27x27	317	39,50	3	000420627
30x30	349	49,00	3	000420630
32x32	370	51,50	3	000420632



42MP/B9N	€	🔧	📦
6-7-8-10-11-13-14-17-19 mm	171,00	1	000420661
2002/BV9	13,40	1	020020030



42MP/S17	€	🔧	📦
6-7-8-9-10-11-12-13-14-15 16-17-18-19-20-21-22 mm	337,00	1	000420652
42MP/S21	511,00	1	000420653
6-7-8-9-10-11-12-13-14 15-16-17-18-19-20-21-22 24-27-30-32 mm			

42LMP

Ring-Maulschlüssel,
lange Ausführung, poliert



Ø mm	L mm	€	🔧	📄
8x8	148	14,80	2	000420508
9x9	167	15,30	2	000420509
10x10	172	15,80	2	000420510
11x11	186	16,60	2	000420511
12x12	197	16,90	2	000420512
13x13	207	17,30	2	000420513
14x14	223	18,40	2	000420514
15x15	233	20,20	2	000420515
16x16	243	21,70	2	000420516
17x17	261	23,00	2	000420517
18x18	270	25,00	2	000420518
19x19	280	25,50	2	000420519
21x21	301	29,50	2	000420521
22x22	318	31,00	2	000420522
24x24	338	36,00	2	000420524
27x27	376	41,00	2	000420527
30x30	409	52,00	2	000420530
32x32	435	56,50	2	000420532



42LMP/S14 € 290,00 1 000420551

8-9-10-11-12-13-14
15-16-17-18-19-21-22 mm

42LMP/S18 € 475,00 1 000420552

8-9-10-11-12-13-14
15-16-17-18-19-21-22
24-27-30-32 mm

42SLIM

Ring-Maulschlüssel mit abgeflachtem Kopf



DIN 3113 UNI-ISO 7738

Ø mm	L mm	S1 mm	€	🔧	📄
8x8	116	3,4	10,50	5	000420408
10x10	137	3,8	11,30	5	000420410
11x11	148	3,8	12,00	5	000420411
12x12	158	4,2	12,20	5	000420412
13x13	169	4,4	12,40	5	000420413
14x14	180	4,6	14,10	5	000420414
15x15	190	4,7	15,40	5	000420415
16x16	201	4,7	15,90	5	000420416
17x17	212	5,1	16,50	5	000420417
18x18	222	5,1	17,70	5	000420418
19x19	233	5,6	18,10	5	000420419



42SLIM/B8NI € 124,50 1 000420478

10-11-12-13-14-15-17-19 mm

42SLIM/B8NE € 128,50 1 000420479

10-11-12-13-16-17-18-19 mm

2002/BV8 € 13,40 1 020020020



42SLIM/S11 € 155,50 1 000420471

8-10-11-12-13-14-15-
16-17-18-19 mm

45

Ring-Maulschlüssel, schwere
Ausführung



DIN 3113 UNI-ISO 7738

Ø mm	L mm	€	🔧	📄
46x46	500	214,50	1	000450046
50x50	540	241,50	1	000450050
55x55	560	345,00	1	000450055
60x60	600	442,00	1	000450060
65x65	675	530,00	1	000450065
70x70	675	581,00	1	000450070
75x75	720	677,00	1	000450075
80x80	720	781,00	1	000450080

52

Einmaulschlüssel



UNI 6733 DIN 3114

Ø mm	L mm	€	🔧	📄
10	119	11,30	5	000520010
11	119	11,60	5	000520011
12	119	11,90	5	000520012
13	145	13,50	5	000520013
14	145	13,80	5	000520014
15	145	14,10	5	000520015
16	159	15,30	5	000520016
17	159	15,40	5	000520017
18	159	16,40	5	000520018
19	175	17,80	5	000520019
20	175	19,00	5	000520020
21	175	19,60	5	000520021
22	196	22,10	2	000520022
23	196	22,70	2	000520023
24	196	23,20	2	000520024
25	215	26,00	2	000520025
26	215	26,50	2	000520026
27	215	26,50	2	000520027
28	240	31,00	2	000520028
30	240	31,50	2	000520030
32	270	37,50	2	000520032
34	270	41,00	1	000520034
35	295	47,00	1	000520035
36	295	47,00	1	000520036
38	295	52,50	1	000520038
40	335	64,50	1	000520040
41	335	64,50	1	000520041
42	335	71,50	1	000520042
45	370	82,00	1	000520045
46	370	82,00	1	000520046
48	370	95,00	1	000520048
50	415	110,50	1	000520050
52	415	124,00	1	000520052
55	415	128,50	1	000520055
60	490	163,00	1	000520060
65	490	166,00	1	000520065
70	490	187,50	1	000520070

53

Einmaulschlüssel DIN 894



Ø mm	L mm	€	🔧	📄
36	317	34,50	1	000530036
38	320	38,00	1	000530038
41	342	44,50	1	000530041
46	396	54,50	1	000530046
50	412	85,00	1	000530050
55	457	97,00	1	000530055
60	492	120,00	1	000530060
65	528	142,50	1	000530065
70	572	165,00	1	000530070
75	608	206,50	1	000530075
80	645	253,00	1	000530080
85	690	307,00	1	000530085
90	690	364,00	1	000530090
95	847	508,00	1	000530095
100	847	537,00	1	000530100
105	1000	670,00	1	000530105
110	1000	725,00	1	000530110
115	1000	809,00	1	000530115
120	1000	917,00	1	000530120
125	1000	1.059,00	1	000530125
130	1000	1.135,00	1	000530130
135	1000	1.215,00	1	000530135

55

Doppelmaulschlüssel



UNI-ISO 10102 DIN 3110

Ø mm	L mm	€	🔧	📄
4x5	101	6,70	5	000550003
5x5,5	101	7,60	5	000550006
5,5x7	120	7,60	5	000550009
• 6x7	120	6,00	5	000550012
7x8	140	7,60	5	000550018
• 8x9	140	6,10	5	000550021
8x10	140	7,60	5	000550024
• 10x11	155	6,40	5	000550030
10x12	155	8,70	5	000550033
10x13	170	9,60	5	000550035
• 12x13	170	7,40	5	000550042
12x14	170	9,80	5	000550045
13x14	185	11,00	5	000550047
13x17	189	11,70	5	000550051
• 14x15	185	9,20	5	000550054
14x17	189	12,60	5	000550057
• 16x17	202	10,40	5	000550060
17x19	220	14,00	2	000550063
• 18x19	220	12,40	2	000550066
19x22	236	15,90	2	000550069
• 20x22	236	14,00	2	000550075
• 21x23	245	14,90	2	000550078
22x24	245	17,30	2	000550081
• 24x26	262	17,70	2	000550087
24x27	262	19,30	2	000550090
• 25x28	272	20,20	2	000550096
• 27x29	284	22,90	2	000550099
27x30	284	26,50	2	000550102
27x32	297	28,50	2	000550105
• 30x32	297	25,50	2	000550108
32x36	325	77,50	1	000550114
34x36	325	77,50	1	000550117
35x38	375	86,00	1	000550120
36x41	375	90,00	1	000550123
41x46	425	103,00	1	000550129
46x50	475	127,50	1	000550132
50x55	500	148,00	1	000550135
55x60	500	156,50	1	000550138



55/B8N	€ 84,00	1	000550160
6x7-8x9-10x11-12x13 14x15-16x17-18x19 20x22 mm			
2002/BV8	13,40	1	020020020
55/B12N	170,50	1	000550164
6x7-8x9-10x11-12x13 14x15-16x17-18x19 20x22-21x23-24x26 25x28-30x32 mm			
2002/BV12	21,60	1	020020040



55/S8	€ 71,00	1	000550174
6x7-8x9-10x11-12x13 14x15-16x17-18x19 20x22 mm			
55/S12	149,00	1	000550178
6x7-8x9-10x11-12x13 14x15-16x17-18x19 20x22-21x23-24x26 25x28-30x32 mm			
55/S12X	150,50	1	000550179
6x7-8x9-10x11-12x13 14x15-16x17-18x19 20x22-21x23-24x27 25x28-30x32 mm			
55/S13	172,00	1	000550182
6x7-8x9-10x11-12x13 14x15-16x17-18x19 20x22-21x23-24x26 25x28-27x29-30x32 mm			



55/SP7



55/SP13

55/SP7	€ 60,50	1	000550167
6x7-8x9-10x11-12x13 14x15-16x17-18x19 mm			
42/SPV7	8,40	1	000420097
42: 8-10-11-13-14-17-19 mm			
55:	6x7-8x9-10x11-12x13 14x15-16x17-18x19 mm		
55/SP13	213,00	1	000550186
6x7-8x9-10x11-12x13 14x15-16x17-18x19 20x22-21x23-24x26 25x28-27x29-30x32 mm			
55/SPV	41,50	1	000550190

55AS Doppelmaulschlüssel



mm	L mm	€	U	PC
1/4x9/32	120	8,00	2	000550203
1/4x5/16	120	8,00	2	000550206
5/16x11/32	140	8,60	2	000550209
5/16x3/8	140	8,60	2	000550212
3/8x7/16	155	9,30	2	000550215
7/16x1/2	170	10,20	2	000550218
1/2x9/16	170	11,00	2	000550221
9/16x5/8	185	12,00	2	000550224
19/32x11/16	189	14,70	2	000550227
5/8x11/16	202	14,70	2	000550230
5/8x3/4	202	16,50	2	000550233
11/16x13/16	220	17,20	2	000550242
3/4x7/8	236	18,50	2	000550245
25/32x13/16	236	18,50	2	000550244
7/8x15/16	245	19,90	2	000550251
15/16x1	262	25,50	1	000550257
1x1.1/8	272	26,50	1	000550259
1.1/16x1.1/4	284	34,50	1	000550267
1.1/8x1.5/16	297	34,50	1	000550266
1.5/16x1.1/2	325	91,50	1	000550269
1.3/8x1.1/2	375	101,00	1	000550272
1.7/16x1.5/8	375	101,00	1	000550275



55AS/5	€ 62,00	1	000550290
5/16x11/32-3/8x7/16 1/2x9/16-5/8x11/16 3/4x7/8			
55AS/8	98,50	1	000550296
1/4x9/32-5/16x11/32-3/8x7/16- 1/2x9/16-9/16x5/8-5/8x11/16- 11/16x13/16-3/4x7/8			
55AS/12	203,50	1	000550298
1/4x9/32-5/16x11/32-3/8x7/16-1 /2x9/16-9/16x5/8-5/8x11/16- 11/16x13/16-25/32x13/16-3/4x7/8- 15/16x1-1x1.1/8-1.1/16x1.1/4			

55MP Doppelmaulschlüssel, poliert



UNI-ISO 10102 DIN 3110

mm	L mm	€	U	PC
6x7	120	7,90	2	000550603
8x9	140	8,50	2	000550606
10x11	155	9,40	2	000550609
12x13	170	10,30	2	000550612
14x15	185	12,30	2	000550615
16x17	202	14,40	2	000550618
18x19	220	16,60	2	000550621
20x22	236	19,00	2	000550624
21x23	245	20,70	2	000550627
24x26	262	24,70	1	000550630
25x28	272	26,00	1	000550633
27x29	284	30,00	1	000550636
30x32	297	34,00	1	000550639



55MP/S8	€ 98,00	1	000550650
6x7-8x9-10x11-12x13 14x15-16x17-18x19 20x22 mm			
55MP/S13	233,50	1	000550651
6x7-8x9-10x11-12x13 14x15-16x17-18x19 20x22-21x23-24x26 25x28-27x29-30x32 mm			
55MP/S12	203,50	1	000550653
6x7-8x9-10x11-12x13-14x15- 16x17-18x19-20x22-21x23-24x26- 25x28-30x32 mm			

58 Schlagmaulschlüssel



DIN 133

mm	L mm	€	U	PC
24	177	36,00	1	000580024
27	180	37,50	1	000580027
30	190	41,50	1	000580030
32	190	43,50	1	000580032
34	200	54,50	1	000580034
36	215	56,00	1	000580036
41	235	66,50	1	000580041
46	255	89,00	1	000580046
50	275	99,50	1	000580050
55	300	119,50	1	000580055
60	320	131,00	1	000580060
65	342	171,50	1	000580065
70	375	221,00	1	000580070
75	375	241,50	1	000580075
80	408	353,00	1	000580080
85	408	395,00	1	000580085
90	445	456,00	1	000580090
95	445	469,00	1	000580095
100	485	649,00	1	000580100
105	485	733,00	1	000580105
110	510	802,00	1	000580110
115	510	913,00	1	000580115
120	545	941,00	1	000580120
125	545	1.078,00	1	000580125
130	575	1.455,00	1	000580130
135	575	1.530,00	1	000580135
*140	575	1.660,00	1	000580140
*145	640	2.270,00	1	000580145
*150	640	2.360,00	1	000580150
*155	640	2.590,00	1	000580155
*160	640	2.840,00	1	000580160
*165	715	3.040,00	1	000580165
*170	715	4.140,00	1	000580170
*175	715	4.380,00	1	000580175
*180	715	4.750,00	1	000580180
*185	715	4.880,00	1	000580185
*190	800	5.360,00	1	000580190
*195	800	5.630,00	1	000580195
*200	800	5.900,00	1	000580200
*210	800	7.360,00	1	000580210
*220	800	9.490,00	1	000580220
*230	800	11.590,00	1	000580230

Doppelmaulschlüssel, kurz



UNI 6737

mm	L mm	€		
4x4	78	10,00	5	000730040
4,5x4,5	78	10,00	5	000730045
5x5	78	10,00	5	000730050
5,5x5,5	86	10,90	5	000730055
6x6	86	10,90	5	000730060
7x7	86	10,90	5	000730070
8x8	97	11,30	5	000730080
9x9	97	11,30	5	000730090
10x10	108	12,30	5	000730100
11x11	108	12,30	5	000730110
12x12	124	14,10	5	000730120
13x13	124	14,10	5	000730130
14x14	124	14,10	5	000730140



	€		
73/B13N 4-4,5-5-5,5-6-7-8-9 10-11-12-13-14 mm	164,50	1	000730202
2002/BV13	13,40	1	020020050



	€		
73/S13 4-4,5-5-5,5-6-7-8-9 10-11-12-13-14 mm	151,50	1	000730210



Schlag-Ringschlüssel



DIN 7444

mm	L mm	€		
24	162	36,50	1	000780024
27	180	43,00	1	000780027
30	190	50,50	1	000780030
32	190	54,00	1	000780032
34	200	61,00	1	000780034
36	205	66,50	1	000780036
41	225	86,00	1	000780041
46	235	96,00	1	000780046
50	250	114,00	1	000780050
55	265	130,00	1	000780055
60	275	158,50	1	000780060
65	295	200,50	1	000780065
70	325	201,50	1	000780070
75	325	239,00	1	000780075
80	350	366,00	1	000780080
85	350	401,00	1	000780085
90	390	490,00	1	000780090
95	390	567,00	1	000780095
100	420	628,00	1	000780100
105	420	740,00	1	000780105
110	450	809,00	1	000780110
115	450	920,00	1	000780115
120	490	1.265,00	1	000780120
125	480	1.710,00	1	000780125
130	520	1.970,00	1	000780130
135	520	2.110,00	1	000780135
*140	520	2.400,00	1	000780140
*145	580	3.030,00	1	000780145
*150	580	3.170,00	1	000780150
*155	580	3.650,00	1	000780155
*160	650	3.740,00	1	000780160
*165	650	3.980,00	1	000780165
*170	650	4.770,00	1	000780170
*175	650	5.160,00	1	000780175
*180	650	5.660,00	1	000780180
*185	695	5.840,00	1	000780185
*190	695	6.390,00	1	000780190
*195	695	6.400,00	1	000780195
*200	695	6.490,00	1	000780200
*210	740	6.920,00	1	000780210
*215	740	7.750,00	1	000780215
*220	740	8.540,00	1	000780220
*230	740	10.590,00	1	000780230

78AS

Schlag-Ringschlüssel



"	L mm	€		
*1.1/16	180	51,50	1	000780327
*1.1/8	190	51,50	1	000780329
*1.3/16	190	51,50	1	000780330
*1.1/4	197	56,00	1	000780332
*1.5/16	197	57,50	1	000780333
*1.3/8	223	61,50	1	000780335
*1.7/16	223	74,50	1	000780336
*1.1/2	223	76,50	1	000780338
*1.5/8	223	87,00	1	000780341
*1.11/16	225	91,00	1	000780343
*1.13/16	240	101,00	1	000780346
*1.7/8	250	102,00	1	000780348
*2	250	116,00	1	000780350
*2.1/16	250	120,00	1	000780352
*2.3/16	275	127,00	1	000780355
*2.3/8	270	172,00	1	000780360
*2.9/16	302	190,00	1	000780365

"	L mm	€		
*2.3/4	350	206,50	1	000780370
*2.15/16	350	239,00	1	000780375
*3.1/8	354	394,00	1	000780380

80

Zwölfkant-Doppelgelenksteckschlüssel



mm	L mm	€		
6x7	170	40,50	3	000800006
8x9	176	41,50	3	000800008
8x10	179	41,50	3	000800009
10x11	182	44,00	3	000800010
12x13	228	50,00	3	000800012
14x15	232	50,50	3	000800014
13x17	231	54,00	3	000800015
16x17	234	54,00	2	000800016
18x19	285	66,50	2	000800018
19x22	287	70,00	2	000800019
20x22	289	70,00	2	000800020
21x23	289	71,00	2	000800021
24x27	405	116,00	2	000800024
30x32	413	123,50	2	000800030



	€		
80/S8 6x7-8x9-10x11-12x13-14x15 16x17-18x19-20x22 mm	415,00	1	000800051
80/S11 6x7-8x9-10x11-12x13 14x15-16x17-18x19-20x22 21x23-24x27-30x32 mm	725,00	1	000800056

83

Starterschlüssel

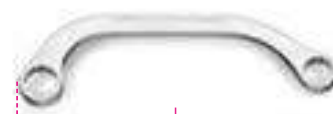

ISO 3318

mm	L mm	€		
8x10	126	20,50	3	000830008
10x12	137	21,30	3	000830010
11x13	138	22,00	3	000830011
14x17	183	28,00	3	000830014
15x17	184	31,50	2	000830015
16x18	196	33,50	2	000830016
19x22	231	44,00	2	000830019



	€		
83/S3 11x13-14x17-19x22 mm	93,00	1	000830081
83/S5 10x12-11x13-15x17 16x18-19x22 mm	152,50	1	000830085

83AS Starterschlüssel



mm	L mm	€	U	PC
7/16x1/2	138	26,50	2	000830111
9/16x5/8	183	31,50	2	000830114
3/4x7/8	230	49,00	2	000830119



mm	L mm	€	U	PC
83AS/3		107,00	1	000830181
7/16x1/2-9/16x5/8 3/4x7/8				

88 Doppelringschlüssel, extralange Ausführung



mm	L mm	€	U	PC
8x10	235	22,90	2	000880008
12x14	330	27,00	2	000880012
13x15	330	27,00	2	000880013
16x18	405	37,50	2	000880016
17x19	405	37,50	2	000880017
21x23	435	43,50	2	000880021
22x24	435	43,50	2	000880022



mm	L mm	€	U	PC
88/S7		238,00	1	000880107
8x10-12x14-13x15-16x18- 17x19-21x23-22x24 mm				

90 Doppelringschlüssel, tief gekröpft



DIN 838 ISO 10104

mm	L mm	€	U	PC
6x7	165	11,30	5	000900006
8x9	180	12,10	5	000900012
8x10	180	14,20	5	000900015
10x11	195	13,30	5	000900018
10x12	195	14,50	5	000900021
11x13	215	15,90	5	000900024
12x13	215	14,60	5	000900027
12x14	215	16,70	5	000900030
14x15	230	15,90	5	000900033
14x17	250	19,70	5	000900036
16x17	250	18,20	5	000900039
17x19	265	23,40	5	000900042
18x19	265	21,20	5	000900045
19x22	285	26,50	3	000900048
20x22	285	24,40	3	000900051
21x23	305	27,50	2	000900057
22x24	305	29,50	2	000900060
24x26	325	31,00	2	000900063
24x27	325	34,00	2	000900067
25x28	340	37,00	2	000900070
27x29	355	39,50	2	000900073
27x30	355	43,50	2	000900076
27x32	375	48,00	2	000900078
30x32	375	44,50	2	000900080
32x36	395	66,50	1	000900088
34x36	415	79,00	1	000900089
35x38	415	80,00	1	000900091
36x41	435	91,00	1	000900094
41x46	460	131,00	1	000900097
46x50	500	172,50	1	000900100



mm	L mm	€	U	PC
90/B8N		143,50	1	000900156
6x7-8x9-10x11-12x13 14x15-16x17-18x19 20x22 mm				
2002/BV8		13,40	1	020020020



mm	L mm	€	U	PC
90/S8		130,50	1	000900162
6x7-8x9-10x11-12x13 14x15-16x17-18x19 20x22 mm				
90/S12		270,00	1	000900166
6x7-8x9-10x11-12x13 14x15-16x17-18x19 20x22-21x23-24x26 25x28-30x32 mm				
90/S12X		274,00	1	000900167
6x7-8x9-10x11-12x13 14x15-16x17-18x19 20x22-21x23-24x27 25x28-30x32 mm				
90/S13		310,00	1	000900170
6x7-8x9-10x11-12x13 14x15-16x17-18x19 20x22-21x23-24x26 25x28-27x29-30x32 mm				



mm	L mm	€	U	PC
90/SP13		351,00	1	000900174
6x7-8x9-10x11-12x13 14x15-16x17-18x19 20x22-21x23-24x26 25x28-27x29-30x32 mm				
55/SPV		41,50	1	000550190

90AS Doppelringschlüssel, tief gekröpft



mm	L mm	€	U	PC
1/4x5/16	165	13,00	2	000900203
5/16x11/32	180	14,00	2	000900206
5/16x3/8	180	14,40	2	000900209
3/8x7/16	195	14,60	2	000900212
7/16x1/2	215	16,40	2	000900215
1/2x9/16	230	18,70	2	000900218
9/16x5/8	230	18,70	2	000900221
19/32x11/16	250	20,40	2	000900222
5/8x11/16	250	21,20	2	000900224
5/8x3/4	265	25,00	2	000900227
11/16x3/4	265	25,00	1	000900230
11/16x13/16	265	25,00	1	000900233
3/4x25/32	265	29,50	1	000900235
3/4x7/8	285	29,50	1	000900237
13/16x7/8	285	29,50	1	000900240
7/8x15/16	305	29,50	1	000900243
15/16x1	325	36,00	1	000900252
1.1/16x1.1/4	375	51,50	1	000900258
1.1/8x1.5/16	375	52,00	1	000900261



mm	L mm	€	U	PC
90AS/8		171,50	1	000900298
1/4x5/16-5/16x11/32 3/8x7/16-1/2x9/16 5/8x11/16-11/16x3/4 13/16x7/8-15/16x1				
90AS/10		275,00	1	000900300
1/4x5/16-5/16x11/32 3/8x7/16-1/2x9/16 5/8x11/16-11/16x3/4 13/16x7/8-15/16x1 1.1/16x1.1/4-1.1/8x1.5/16				



 Beta

 Beta

91 Aufsteckringschlüssel



Ø mm	Ø mm	€	🔧	📄
24	38	65,00	1	000910024
27	41	67,00	1	000910027
30	48	72,00	1	000910030
32	49	77,50	1	000910032
36	54	89,00	1	000910036
41	62	105,50	1	000910041
46	69	123,50	1	000910046
50	76	141,00	1	000910050
55	81	157,50	1	000910055
60	90	196,50	1	000910060
65	98	220,00	1	000910065
70	105	247,50	1	000910070
75	110	284,00	1	000910075
80	125	325,00	1	000910080
85	125	339,00	1	000910085
90	140	608,00	1	000910090
95	140	664,00	1	000910095
100	143	705,00	1	000910100
105	146	787,00	1	000910105

92 Aufsteckrohre für Art. 91

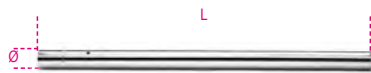

	L mm	91 mm	Ø mm	€	🔧	📄
92/1	460	24÷30	19	39,00	1	000920010
92/2	610	32÷41	22	60,00	1	000920020
92/3	760	46÷55	25	85,00	1	000920030
92/4	860	60÷105	30	113,00	1	000920040

93 Doppelringschlüssel, flach gekröpft, speziell für Gerüste



Ø mm	L mm	€	🔧	📄
21x22	310	46,50	3	000930021

93C Doppelknarrenringschlüssel, flach gekröpft, speziell für Gerüste



Ø mm	L mm	€	🔧	📄
17x19	310	52,50	1	000930117
19x22	310	56,00	1	000930119
19x24	365	69,50	1	000930120
21x22	310	63,00	1	000930121
36x38	445	106,00	1	000930136

94 Offene Ringschlüssel



DIN 3118

Ø mm	L mm	€	🔧	📄
8x10	140	19,70	2	000940008
9x11	153	20,50	2	000940009
10x11	153	21,60	2	000940010
11x13	175	22,30	2	000940011
12x14	175	23,60	2	000940012
13x15	175	23,60	2	000940013
14x15	175	28,00	2	000940014
14x17	195	28,50	2	000940015
17x19	212	29,00	2	000940017
19x22	228	31,00	2	000940019
22x24	242	38,00	2	000940022
24x27	260	41,50	2	000940024
30x32	300	54,00	2	000940030
36x41	320	91,50	1	000940036



	€	🔧	📄
94/S6 8x10-10x11-11x13-12x14 17x19-19x22 mm	147,00	1	000940050
94/S10 8x10-9x11-10x11-11x13 12x14-17x19-19x22 22x24-24x27-30x32 mm	300,00	1	000940052

95 Doppelringschlüssel, gerade



DIN 837 ISO 10103

Ø mm	L mm	€	🔧	📄
6x7	120	12,90	3	000950161
8x9	135	13,90	3	000950162
10x11	150	15,70	3	000950163
12x13	165	17,00	3	000950164
14x15	185	17,90	3	000950165
16x17	210	19,00	3	000950166
17x19	225	22,10	3	000950167
18x19	225	22,10	2	000950168
20x22	240	25,00	2	000950169
21x23	255	26,50	2	000950170
24x26	270	28,00	2	000950171
25x28	285	33,50	2	000950172
27x29	315	34,00	2	000950173
30x32	335	38,50	2	000950174



	€	🔧	📄
95/S8 6x7-8x9-10x11-12x13 14x15-16x17-18x19 20x22 mm	143,00	1	000950177
95/S13 6x7-8x9-10x11-12x13 14x15-16x17-18x19 20x22-21x23-24x26 25x28-27x29-30x32 mm	303,00	1	000950179

95FTX Doppelringschlüssel, gerade, für Torx®-Schrauben



Ø	L mm	€	🔧	📄
E6xE8	115	13,30	2	000950306
E10xE12	143	14,00	2	000950310
E14xE18	177	15,90	2	000950314
E20xE24	224	21,60	2	000950320



	€	🔧	📄
95FTX/S4 E6xE8-E10xE12 E14xE18-E20xE24	64,50	1	000950325



SECHSKANT-STIFTSCHLÜSSEL

Die Stiftschlüssel Beta sind für eine hohe Präzision und eine lange Lebensdauer ausgelegt. Die breite Produktpalette deckt jeden Einsatzzweck ab: extrakurze, kurze, lange, extralange Schlüssel, mit Kugelkopf bis hin zu Stiftschlüsseln mit T-Profil und mit Griff, wahre unverwechselbare Artikel der Marke Beta und ohne jeglichen Vergleich auf dem Markt.

Die Schlüssel mit Kugelkopf ermöglichen das Arbeiten bis zu 30° zur Schraubenachse.

Der Halter mit aufklappbarer Öffnung ermöglicht die schnelle Ermittlung des notwendigen Maßes und verhindert durch das mögliche Schließen, dass selbst der kleinste der Schlüssel herausfallen kann.

Zusätzlich zu den optimalen Eigenschaften der Standardschlüssel erlaubt die Version Color die sofortige Erkennung der Schlüsselweite, um die tägliche Arbeit zu beschleunigen.

96
Sechskant-Stiftschlüssel,
gebogen, verchromt



ISO 2936

mm	L mm	L1 mm	€	📦	🚚
0,9	35	8	1,30	20	000960013
1,3	39	10	1,30	20	000960014
1,5	45	15	1,30	20	000960015
2	50	17	1,40	20	000960020
2,5	57	20	1,40	20	000960025
3	64	22	1,50	20	000960030
3,5	68	25	1,80	20	000960035
4	72	28	1,80	20	000960040
4,5	78	30	1,90	20	000960045
5	83	32	1,90	20	000960050
5,5	88	35	2,50	20	000960055
6	94	37	2,50	20	000960060
7	99	40	3,10	10	000960070
8	105	43	3,50	10	000960080
9	111	46	4,20	10	000960090
10	119	49	4,90	10	000960100
11	126	52	6,20	10	000960110
12	134	56	7,40	10	000960120
13	142	62	9,40	10	000960130
14	151	69	11,00	10	000960140
16	165	75	16,10	5	000960160
17	174	79	16,90	5	000960170
19	196	88	23,60	5	000960190
22	216	100	37,00	3	000960220
24	242	112	48,50	1	000960240
27	271	125	64,50	1	000960270
30	309	140	86,50	1	000960300
32	341	155	114,00	1	000960312
36	385	174	164,00	1	000960316



96/ST6 16,40 3 000960370
2,5-3-4-5-6-8 mm



96/BGS7 36,50 1 000960367
1,5-2-2,5-3-4-5-6 mm



96/BG7 38,50 1 000960368
2,5-3-4-5-6-8-10 mm



96/B8 20,50 5 000960386
2-2,5-3-4-5-6-8-10 mm
96/B10 29,00 5 000960380
1,5-2-2,5-3-4-5-6-8-10-12 mm
96N/BV 2,40 1 000960651



96/SC9 24,40 1 000960374
1,5-2-2,5-3-4-5-6-8-10 mm
96/SCV 5,10 1 000960985



96/SC12 34,50 1 000960395
2-2,5-3-3,5-4-4,5-5-6-7-8-9-10 mm
96/SCV12 6,00 1 000960975

96N
Sechskant-Stiftschlüssel,
gebogen, brüniert



ISO 2936

mm	L mm	L1 mm	€	📦	🚚
0,9	32	10	0,63	20	000960409
1,3	44	12	0,63	20	000960413
1,5	46	15	0,70	20	000960415
2	51	17	0,70	20	000960420
2,5	57	20	0,80	20	000960425
3	64	22	0,80	20	000960430
3,5	68	25	1,00	20	000960435
4	72	28	1,10	20	000960440
4,5	78	30	1,20	20	000960445
5	83	32	1,20	20	000960450
6	94	37	1,50	20	000960460
7	99	40	2,10	10	000960470
8	105	43	2,40	10	000960480
9	111	46	3,10	10	000960490
10	119	49	3,60	10	000960500
11	126	52	4,50	10	000960510
12	134	56	5,40	10	000960520
13	142	62	7,20	10	000960530
14	151	69	8,10	10	000960540
16	165	72	12,10	5	000960560
17	174	79	13,00	5	000960570
19	194	88	17,60	5	000960590
22	216	99	32,50	1	000960592
24	242	111	43,00	1	000960594



96N/ST6 € 11,60 3 000960640
2,5-3-4-5-6-8 mm



96N/G7 € 30,00 3 000960645
2,5-3-4-5-6-8-10 mm
96N/G7A € 21,20 3 000960643
1,5-2-2,5-3-4-5-6 mm



96N/B10 € 19,60 5 000960650
1,5-2-2,5-3-4-5-6
8-10-12 mm
96N/BV € 2,40 1 000960651



96N/SC9 € 17,10 1 000960644
1,5-2-2,5-3-4-5-6-8-10 mm
96N/SCV € 5,10 1 000960986



96N/SC12 € 24,30 1 000960661
2-2,5-3-3,5-4-4,5-5
6-7-8-9-10 mm
96N/SCV12 € 6,00 1 000960976



96C/AS

Sechskant-Stiftschlüssel, gebogen, verchromt



"	L mm	L1 mm	g	€	Hand	Computer
1/16	46	16	1,01	2,10	20	000961702
3/32	53	19	2,70	2,80	20	000961706
1/8	60	22	5,33	3,10	20	000961710
5/32	67	25	9,33	3,50	20	000961714
3/16	74	28	14,87	4,00	20	000961716
7/32	81	32	22,00	4,50	20	000961718
1/4	89	35	31,40	4,90	20	000961720
5/16	103	40	56,16	5,60	10	000961724
3/8	117	45	91,31	6,80	10	000961728



96C-AS/SC9 € 41,50 1 000961753
1/16-3/32-1/8-5/32-3/16-
7/32-1/4-5/16-3/8

96AS

Sechskant-Stiftschlüssel, gebogen, brüniert



"	L mm	L1 mm	€	Hand	Computer
1/30 (0,035")	44	14	1,20	20	000960698
1/20 (0,050")	44	15	1,20	20	000960701
1/16	46	16	1,30	20	000960702
5/64	50	18	1,50	20	000960704
3/32	53	19	1,70	20	000960706
7/64	57	21	1,70	20	000960708
1/8	60	22	1,70	20	000960710
9/64	64	24	2,10	20	000960712
5/32	68	25	2,20	20	000960714
3/16	75	29	2,40	20	000960716
7/32	82	32	2,60	20	000960718
1/4	89	35	3,10	20	000960720
5/16	103	40	3,70	10	000960724
3/8	117	44	4,50	10	000960728
7/16	132	49	6,50	10	000960730
1/2	149	54	8,20	10	000960732
9/16	151	69	13,30	2	000960734



96AS/SC9 € 27,00 1 000960743
1/16-3/32-1/8-5/32-3/16-
7/32-1/4-5/16-3/8
96AS/SCV € 5,10 1 000960744



96AS/T7 € 21,90 3 000960740
3/32-1/8-5/32
3/16-7/32-1/4-5/16



96AS/BG7 € 38,50 1 000960747
3/32-1/8-5/32-3/16
1/4-5/16-3/8



96AS/B11 € 26,50 1 000960749
1/20-1/16-5/64-3/32
1/8-5/32-3/16-7/32
1/4-5/16-3/8
96N/BV € 2,40 1 000960651



96LC

Sechskant-Stiftschlüssel, gebogen, lange Ausführung, verchromt



ISO 2936

mm	L mm	L1 mm	€	Hand	Computer
2	101	17	2,30	20	000960320
2,5	113	20	2,40	20	000960321
3	127	22	2,60	20	000960322
3,5	138	25	2,70	20	000960323
4	142	28	2,90	20	000960324
4,5	154	28	3,40	20	000960325
5	163	32	3,60	20	000960326
6	184	37	4,00	20	000960327
7	194	40	4,50	10	000960328
8	205	43	5,60	10	000960329
9	216	46	6,00	10	000960330
10	231	49	7,80	10	000960331
12	259	56	9,70	10	000960332



96LC/SC8	€ 35,50	1	000960334
2-2,5-3-4-5-6-8-10 mm			
96LC/SCV	€ 5,10	1	000960983



96LC/SC12	€ 52,50	1	000960337
2-2,5-3-3,5-4-4,5-5-6-7-8-9-10 mm			
96LC/SCV12	€ 6,00	1	000960977

96L

Sechskant-Stiftschlüssel, gebogen, lange Ausführung, brüniert



ISO 2936

mm	L mm	L1 mm	€	Stk	Art-Nr
2	99	15	1,60	20	000960820
2,5	110	17	1,70	20	000960825
3	124	19	1,80	20	000960830
3,5	135	21	1,90	20	000960835
4	138	24	2,20	20	000960840
4,5	150	25	2,60	20	000960845
5	158	27	2,70	20	000960850
6	178	31	3,10	20	000960860
7	187	33	3,80	10	000960870
8	197	35	4,90	10	000960880
9	207	37	5,50	10	000960890
10	221	39	7,30	10	000960900
12	247	44	9,30	10	000960920



96L/SC8	€ 29,50	1	000960924
2-2,5-3-4-5-6-8-10 mm			
96L/SCV	€ 5,10	1	000960987



96L/SC12	€ 44,00	1	000960929
2-2,5-3-3,5-4-4,5-5-6-7-8-9-10 mm			
96L/SCV12	€ 6,00	1	000960978

96BP-CL

Sechskant-Stiftschlüssel, gebogen, verchromt, farbig



mm	L mm	L1 mm	€	Stk	Art-Nr
1,5	91	16	3,50	5	000961600
2	102	17	3,80	5	000961601
2,5	113	21	4,30	5	000961602
3	128	23	4,80	5	000961603
4	143	28	5,30	5	000961604
5	163	33	5,70	5	000961605
6	185	37	7,30	5	000961606
8	206	43	9,90	2	000961608
10	231	50	13,00	2	000961610



96BP-CL/SC9	€ 62,00	1	000961619
1,5-2-2,5-3-4-5-6-8-10 mm			
96BP-CL/SCV	€ 5,10	1	000961629

96BPC

Sechskant-Stiftschlüssel, gebogen, mit kugelförmigem Kopf, verchromt

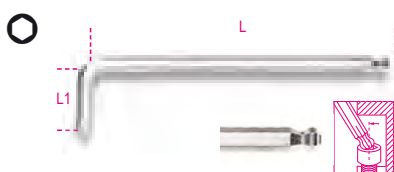

mm	L mm	L1 mm	€	Stk	Art-Nr
1,5	79	13	2,60	10	000960340
2	84	15	2,80	10	000960341
2,5	89	17	2,90	10	000960342
3	99	19	3,10	10	000960343
4	108	24	3,50	10	000960344
5	126	27	4,30	10	000960345
6	148	31	6,00	10	000960346
7	157	33	7,90	5	000960353
8	168	35	8,10	5	000960347
10	187	39	13,00	5	000960348
12	220	55	16,70	5	000960352



96BPC/SC9	€ 50,50	1	000960354
1,5-2-2,5-3-4-5-6-8-10 mm			
96BPC/SCV	€ 5,10	1	000960984

96BP

Sechskant-Stiftschlüssel, gebogen, mit kugelförmigem Kopf, brüniert

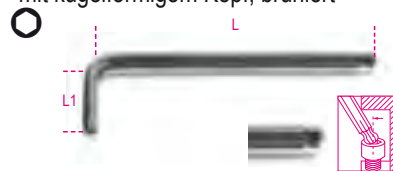

mm	L mm	L1 mm	€	Stk	Art-Nr
1,5	79	13	2,10	10	000960960
2	84	15	2,20	10	000960961
2,5	89	17	2,20	10	000960962
3	99	19	2,40	10	000960963
4	108	24	2,60	10	000960965
5	126	27	3,50	10	000960967
6	148	31	4,90	10	000960968
8	168	35	7,00	5	000960970
10	187	39	11,90	5	000960972
12	220	55	17,70	5	000960973



96BP/SC9	€ 43,00	1	000960974
1,5-2-2,5-3-4-5-6-8-10 mm			
96BP/SCV	€ 5,10	1	000960988

96LBP

Sechskant-Stiftschlüssel, gebogen, mit kugelförmigem Kopf, extra lange Ausführung



mm	L mm	L1 mm	€	Stk	Art-Nr
1,5	90	15	3,10	5	000961340
2	100	17	3,30	5	000961341
2,5	112	20	3,40	5	000961342
3	127	22	3,50	5	000961343
4	144	27	4,40	5	000961344
5	163	32	5,20	5	000961345
6	184	37	7,10	5	000961346
8	204	44	9,80	2	000961348
10	230	49	15,50	2	000961350



96LBP/SC9	€ 59,50	1	000961354
1,5-2-2,5-3-4-5-6-8-10 mm			
96LBP/SCV	€ 5,10	1	000961984

96BP/AS

Sechskant-Stiftschlüssel, gebogen, mit kugelförmigem Kopf, brüniert

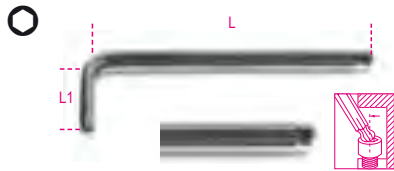

"	L mm	L1 mm	€	🔧	📦
3/32	89	17	2,50	10	000960989
1/8	98	18	2,60	10	000960990
5/32	108	24	3,10	10	000960991
3/16	126	26	3,50	10	000960992
7/32	139	28	5,00	10	000960993
1/4	152	31	5,50	10	000960994
5/16	168	34	7,20	5	000960995
3/8	190	39	11,80	5	000960996



€	🔧	📦
46,50	1	000961000
5,10	1	000961001



€	🔧	📦
42,50	1	000960997
2,40	1	000960998

96BPA

Sechskant-Stiftschlüssel, gebogen um 110°, mit kugelförmigem Kopf, extra kurze Seitenausführung



mm	L mm	L1 mm	€	🔧	📦
1,5	71	9	2,80	5	000961960
2	86	11	3,10	5	000961961
2,5	96	13	3,20	5	000961962
3	104	15	3,40	5	000961963
4	116	17	4,10	5	000961964
5	132	19	4,80	5	000961965
6	155	21	6,90	5	000961966
8	176	24	9,20	2	000961968
10	200	27	14,20	2	000961970



€	🔧	📦
56,00	1	000961974
5,10	1	000961988

96T

96T SECHSKANT-STIFTSCHLÜSSEL MIT GRIFF

Schnell und handlich

Der Griff ist klein bemessen und perfekt ausgeglichen, um schnell in der Handfläche zu drehen.

Die ergonomische Form ermöglicht seine Benutzung auch für sehr hohe Drehmomente.

Die sechskantigen Enden sind kalibriert, um das höchst mögliche Drehmoment auf die Schraube zu übertragen.

Der Stab mit rundem Querschnitt hat eine gleichmäßigere Struktur im Vergleich zu dem sechskantigen Stab und bietet darüber hinaus einen höheren Widerstand.



Durchlaufendes Messer innen im Griff

96T

Sechskant-Stiftschlüssel mit Griff



mm	L mm	L1 mm	€	🔧	📦
2	139	52	13,30	5	000960934
2,5	153	55	13,30	5	000960935
3	153	55	14,00	5	000960936
3,5	179	70	14,50	5	000960937
4	179	70	14,50	5	000960938
4,5	200	84	14,80	5	000960939
5	200	84	14,80	5	000960940
6	221	103	16,90	5	000960941
7	236	106	18,60	3	000960942
8	255	117	21,60	3	000960943
10	285	132	24,80	3	000960945



€	🔧	📦
73,50	1	000960946
86,50	1	000960952
133,00	1	000960933
181,00	1	000960951



€	🔧	📦
226,00	1	000960957
50,50	1	000960958

96T/AS

Sechskant-Stiftschlüssel mit Griff



"	L mm	L1 mm	€	🔧	📦
3/32	153	55	16,60	2	000960669
7/64	153	55	16,60	2	000960670
1/8	179	70	16,80	2	000960671
9/64	179	70	17,60	2	000960672
5/32	200	84	17,60	2	000960673
3/16	200	84	17,60	2	000960674
7/32	221	103	19,60	2	000960675
1/4	236	106	21,80	2	000960676
5/16	255	117	24,80	2	000960678
3/8	285	132	29,50	2	000960680



€	🔧	📦
161,00	1	000960682
198,00	1	000960683

96TBP

Sechskant-Stiftschlüssel, gebogen, mit kugelförmigem Kopf und Griff



mm	L mm	L1 mm	€	🔧	📦
2,5	153	55	14,00	3	000960685
3	153	55	14,70	3	000960686
4	179	70	15,50	3	000960687
5	200	84	16,10	3	000960688
6	221	103	17,60	3	000960689
8	255	117	23,30	2	000960690
10	285	132	24,80	2	000960692

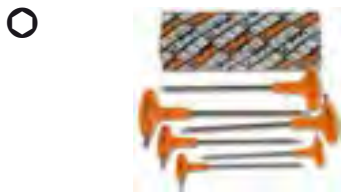

96TBP/S6	2,5-3-4-5-6-8 mm	101,00	1	000960694
-----------------	------------------	--------	---	-----------

97TX

Stiftschlüssel, gebogen, für Torx®-Schrauben

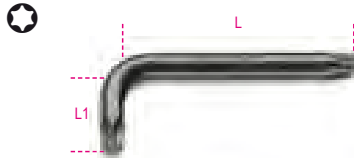

mm	L mm	L1 mm	€	🔧	📦
T6	42	16	7,50	5	000970006
T7	48	16	7,50	5	000970007
T8	48	16	7,50	5	000970008
T9	48	16	8,20	5	000970009
T10	51	17	8,40	5	000970010
T15	54	18	8,40	5	000970015
T20	57	19	9,00	5	000970020
T25	60	20	9,20	5	000970025
T27	64	21	10,00	5	000970027
T30	70	24	10,00	5	000970030
T40	76	26	11,20	5	000970040
T45	83	29	13,30	5	000970045
T50	95	32	15,30	5	000970050
T55	108	35	19,40	5	000970055
T60	120	38	25,50	5	000970060



97TX/ST8	T9-T10-T15-T20-T25-T27-T30-T40	80,00	1	000970640
-----------------	--------------------------------	-------	---	-----------



97TX/G8	T9-T10-T15-T20-T25-T27-T30-T40	62,50	1	000970645
----------------	--------------------------------	-------	---	-----------



97TX/BG8	T9-T10-T15-T20-T25-T27-T30-T40	50,00	1	000970368
-----------------	--------------------------------	-------	---	-----------



97TX/SC8	T9-T10-T15-T20-T25-T27-T30-T40	79,00	1	000970064
-----------------	--------------------------------	-------	---	-----------

97TX/SCV		5,10	1	000970985
-----------------	--	------	---	-----------



97TX/B13	T6-T7-T8-T9-T10-T15-T20-T25-T27-T30-T40-T45-T50	127,00	1	000970650
-----------------	---	--------	---	-----------

96N/BV		2,40	1	000960651
---------------	--	------	---	-----------

97BTX

Stiftschlüssel mit kugelförmigem Kopf, für Torx®-Schrauben

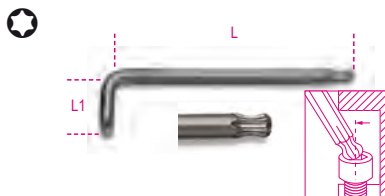

mm	L mm	L1 mm	€	🔧	📦
T9	62	16	9,50	5	000970109
T10	71	17	9,50	5	000970110
T15	81	18	9,50	5	000970115
T20	92	19	10,20	5	000970120
T25	94	20	10,90	5	000970125
T27	105	21	11,60	5	000970127
T30	114	24	11,70	5	000970130
T40	129	26	13,50	5	000970140
T45	133	28	15,80	5	000970145



97BTX/SC8	T9-T10-T15-T20-T25-T27-T30-T40	91,00	1	000970164
------------------	--------------------------------	-------	---	-----------

97BTX/SCV		5,10	1	000970983
------------------	--	------	---	-----------



97BTX/B8	T9-T10-T15-T20-T25-T27-T30-T40	88,00	1	000970159
-----------------	--------------------------------	-------	---	-----------

96N/BV		2,40	1	000960651
---------------	--	------	---	-----------

97BTX-C

Stiftschlüssel mit kugelförmigem Kopf, für Torx®-Schrauben, farbig



mm	L mm	L1 mm	€	🔧	📦
T9	80	16	10,50	5	000971609
T10	86	17	10,50	5	000971610
T15	90	18	10,50	5	000971615
T20	95	19	11,50	5	000971620
T25	100	20	12,30	5	000971625
T27	105	21	12,90	5	000971627
T30	114	24	13,30	5	000971630
T40	124	26	14,70	5	000971640



97BTX-C/SC8	T9-T10-T15-T20-T25-T27-T30-T40	100,50	1	000971658
--------------------	--------------------------------	--------	---	-----------

97BTX-C/SCV		5,10	1	000971659
--------------------	--	------	---	-----------



97BTXL

Stiftschlüssel mit kugelförmigem Kopf, lange Ausführung, für Torx®-Schrauben



	L mm	L1 mm	€	🛒	📄
T9	80	15	10,00	3	000970309
T10	86	17	10,00	3	000970310
T15	100	18	10,00	3	000970315
T20	110	19	11,50	3	000970320
T25	126	20	12,60	3	000970325
T27	140	24	14,10	3	000970327
T30	160	28	14,70	3	000970330
T40	176	32	17,50	3	000970340



97BTXL/SC8	105,00	1	000970364
T9-T10-T15-T20-T25-T27-T30-T40			
97BTXL/SCV	5,10	1	000970982

97RTX

Stiftschlüssel, gebogen, für Sicherheitsschrauben Tamper Resistant Torx®



	L mm	L1 mm	€	🛒	📄
T6	40	15	9,10	5	000970206
T7	45	15	9,10	5	000970207
T8	50	16	9,10	5	000970208
T9	56	16	9,10	5	000970209
T10	62	17	9,10	5	000970210
T15	72	17	9,10	5	000970215
T20	83	18	9,30	5	000970220
T25	90	18	9,60	5	000970225
T27	100	20	10,70	5	000970227
T30	105	24	10,90	5	000970230
T40	112	26	11,90	5	000970240
T45	118	26	14,00	5	000970245
T50	122	28	18,10	3	000970250
T55	128	30	20,70	3	000970255



97RTX/SC8	84,00	1	000970263
T9-T10-T15-T20-T25-T27-T30-T40			
97RTX/SCV	5,10	1	000970984



97RTX/B8	81,00	1	000970260
T9-T10-T15-T20-T25-T27-T30-T40			
96N/BV	2,40	1	000960651

97BRTXL/SC8

Stiftschlüsselsatz mit kugelförmigem Kopf, 8-teilig, lange Ausführung, für Tamper Resistant Torx®-Schrauben



97BRTXL/SC8	95,00	1	000970464
T9-T10-T15-T20-T25-T27-T30-T40			
97BRTXL/SCV	5,10	1	000970986

97TTX

Stiftschlüssel mit Griff, für Torx®-Schrauben



	L mm	L1 mm	€	🛒	📄
T6	130	52	13,80	3	000970706
T7	130	52	13,80	3	000970707
T8	139	52	13,90	3	000970708
T9	139	52	13,90	3	000970709
T10	179	70	14,20	3	000970710
T15	179	70	15,40	3	000970715
T20	179	70	15,90	3	000970720
T25	179	70	16,90	3	000970725
T27	200	84	18,60	3	000970727
T30	200	84	19,30	3	000970730
T40	221	103	22,90	3	000970740
T45	236	106	27,00	2	000970745
T50	255	117	34,00	2	000970750



97TTX/S6	104,50	1	000970791
T10-T15-T20-T25-T30-T40			
97TTX/S8	136,50	1	000970808
T8-T10-T15-T20-T25-T27-T30-T40			
97TTX/S11	211,00	1	000970800
T8-T9-T10-T15-T20-T25-T27-T30-T40-T45-T50			
97TTX/S13	238,50	1	000970813
T6-T7-T8-T9-T10-T15-T20-T25-T27-T30-T40-T45-T50			



97TTX/SP11	256,00	1	000970840
T8-T9-T10-T15-T20-T25-T27-T30-T40-T45-T50			
96T/SPV	50,50	1	000960958
96T/S11			
97TTX/S11			

98XZN

Gebogene Stiftschlüssel für Vielzahnschrauben (XZN®)

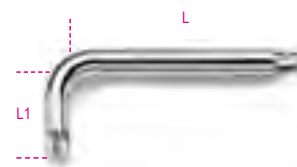

DIN 65253

	L mm	L1 mm	€	🛒	📄
M5	83	25	6,50	5	000980005
M6	89	30	7,50	5	000980006
M8	97	32	9,40	5	000980008
M10	106	35	12,40	5	000980010
M12	116	37	15,60	5	000980012



98XZN/B5	53,00	1	000980650
M5-M6-M8-M10-M12			
96N/BV	2,40	1	000960651

99

Hakenschlüssel mit Nase, für Nutmuttern UNI/ISO 2982, 2983



UNI 6752

	A mm	€	🛒	📄
12-14	1,5	12,50	3	000990012
16-18-20	1,8	12,50	3	000990016
22-25-28	1,8	16,60	3	000990022
30-32	2,1	16,60	3	000990030
34-36-38	2,4	20,20	3	000990034
40-42	2,4	20,20	3	000990040
45-50	2,5	25,00	3	000990045
52-55-58	2,5	25,00	3	000990052
62-65	3,1	31,50	3	000990062
68-70-75	3,1	31,50	3	000990068
80-85-90	3,8	42,50	2	000990080
92-95	4,3	42,50	2	000990092
98-100	4,3	42,50	2	000990098
105-110-115	4,4	66,50	1	000990105
120-125-130	4,9	66,50	1	000990120
135-145	6,0	98,00	1	000990135
155-165	6,0	98,00	1	000990155

99SQ

Hakenschlüssel mit Nase
für Nutmuttern



Ø mm	B mm	€	U	IT
15-35	2,7	33,50	2	000990215
35-50	3,5	38,00	2	000990235
50-80	4,7	50,00	2	000990250
80-120	6,2	68,00	2	000990280
120-180	7,8	91,00	2	000990290

99ST

Hakenschlüssel, verstellbar,
für Lochmuttern



Ø mm	Ø mm	B mm	€	U	IT
15-35	3,0	2,5	34,00	2	000990315
35-50	4,0	4,5	40,50	2	000990335
50-80	5,0	5,0	54,00	2	000990350
80-120	6,0	7,0	73,00	2	000990380
120-180	8,0	9,0	95,00	2	000990390

99 VN/...

Ersatzstift für Art. 99ST

	Ø mm	€	U	IT
99ST VN/15	15-35	9,40	1	000990295
99ST VN/35	35-50	10,90	1	000990296
99ST VN/50	50-80	13,30	1	000990297
99ST VN/80	80-120	15,40	1	000990298
99ST VN/120	120-180	20,20	1	000990299

100

Schlüssel für Muttern mit Stirnloch



Ø mm	L mm	Ø min-max mm	€	U	IT
4,8-5,8 6,9-7,9	250	18÷100	175,00	1	001000001

100/KIT

Ersatzstifte für Art.100



100/KIT	€	U	IT
	54,00	1	001000010

111E

EINMAULSCHLÜSSEL VERSTELLBAR

Die neuen verstellbaren Einmaulschlüssel **Beta 111E** ermöglichen dank der über die mittige Rolle verstellbaren, beweglichen Backe das Verschrauben und Lösen von Muttern und Bolzen verschiedener Größen. 15° abgewinkelter Kopf für das Handhaben selbst in schwierigsten Bereichen, wie unsere kultigen „42er“



Überdimensionale
Schlüsselöffnung

Geringer Platzbedarf
auch bei vollständig
geöffnetem
Backenkopf

Doppelte
Laserbeschriftung
in mm/Zoll

Neu konzipierte Ergonomie mit 20 %
weniger Gewicht
Aus legiertem Hochleistungsstahl
für eine hohe mechanische
Torsionsfestigkeit
Spezielle Hitzebehandlungen für eine
hervorragende Verschleißfestigkeit
Loch am Griff zum Aufhängen

111E

Einmaulschlüssel, verstellbar, mit Messskala,
verchromt

- Rechtsdrehung der Rolle
- Messskala in mm/Zoll



DIN 3117 ISO 6787

L mm	L "	A max mm	€	U	IT
100	4	15	29,00	3	001110110
150	6	24	30,00	3	001110115
200	8	29	37,00	3	001110120
250	10	34	44,50	3	001110125
300	12	40	59,00	3	001110130
380	15	45	116,00	3	001110138
450	18	54	193,00	2	001110145
600	24	62	267,00	1	001110160

111EN

Einmaulschlüssel verstellbar, mit Messskala,
phosphatiert

- Linksdrehung der Rolle
- Messskala in mm/Zoll



DIN 3117 ISO 6787

L mm	L "	A max mm	€	U	IT
100	4	15	26,50	3	001110410
150	6	24	28,00	3	001110415
200	8	29	32,50	3	001110420
250	10	34	40,50	3	001110425
300	12	40	54,00	3	001110430
380	15	45	107,50	3	001110438
450	18	54	182,50	2	001110445

111ER

Einmaulschlüssel, verstellbar, mit
Wendebacke und Messskala, verchromt

- Wendebacke
- Rechtsdrehung der Rolle
- Messskala in mm/Zoll



L mm	L "	A max mm	Ø max "	€	U	IT
200	8	29	3/4	38,50	3	001110520
250	10	34	1	47,50	3	001110525
300	12	40	1.1/4	62,00	2	001110530

111CM

Einmaulschlüssel, verstellbar, kurze
Ausführung, mit überdimensionaler Öffnung,
verchromt

- Überdimensionale Schlüsselöffnung
- Rechtsdrehung
- Maß Skala in mm/Zoll



L mm	L "	A max mm	€	U	IT
170	6	32	44,00	2	001110770
220	8	38	53,50	3	001110722
270	10	46	71,00	3	001110727

120 Offene Knarrenringschlüssel

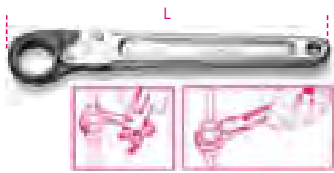

Ø mm	L mm	€	Hand	PC
10	135	55,50	1	001200010
11	135	55,50	1	001200011
12	135	55,50	1	001200012
13	135	55,50	1	001200013
14	135	62,50	1	001200014
17	185	67,50	1	001200017
19	185	72,00	1	001200019
22	230	98,00	1	001200022
24	230	105,00	1	001200024
27	230	133,50	1	001200027
30	320	151,50	1	001200030
32	320	160,50	1	001200032



120/B6N 10-11-13 17-19-22 mm	€ 416,00	Hand 1	PC 001200060
2002/BVL6	€ 13,40	Hand 1	PC 020020010

123E1/4 Adapter für Einsatzhalter 1/4" für 10 mm Knarrenringschlüssel

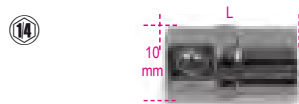

Ø mm	L mm	€	Hand	PC
10	20,6	7,30	1	001230010

123Q1/4 Adapter mit Schnellanschluss 1/4" für 10 mm Knarrenringschlüssel

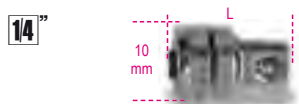

Ø mm	L mm	€	Hand	PC
10	17,5	10,10	1	001230310

123Q3/8 Adapter mit Schnellanschluss 3/8" für 13 mm Knarrenringschlüssel



Ø mm	L mm	€	Hand	PC
13	22,5	10,20	1	001230313

123Q1/2 Adapter mit Schnellanschluss 1/2" für 19 mm Knarrenringschlüssel

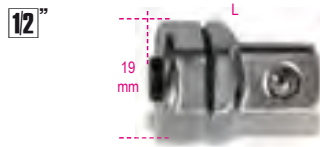

Ø mm	L mm	€	Hand	PC
19	30,5	10,90	1	001230319

123/K4 Adaptersatz für Knarrenringschlüssel, 4-teilig: 1 Bitsadapter 3 Adapter mit Schnellanschluss



123/K4	€ 38,00	Hand 1	PC 001230504
--------	---------	--------	--------------

141 Gerade Ring-Maulschlüssel mit Knarre



ISO 21982:2020

Ø mm	L mm	€	Hand	PC
8x8	136	18,30	3	001410008
9x9	143	19,00	3	001410009
10x10	160	19,60	3	001410010
11x11	168	19,90	3	001410011
12x12	174	20,70	3	001410012
13x13	180	22,50	3	001410013
14x14	193	23,50	2	001410014
15x15	200	24,50	2	001410015
16x16	216	27,00	2	001410016
17x17	233	27,50	2	001410017
18x18	239	29,00	2	001410018
19x19	250	29,50	2	001410019



141/B6 8-10-13-14-17-19 mm	€ 151,00	Hand 1	PC 001410066
141/B9 8-10-11-12-13-14-15-17-19 mm	€ 218,00	Hand 1	PC 001410069



141/S12 8-9-10-11-12-13-14-15-16-17-18-19 mm	€ 281,00	Hand 1	PC 001410072
---	----------	--------	--------------

142 RING-MAULSCHLÜSSEL MIT KNARRE

Schnelligkeit der Umschaltknarre mit 72 Zähnen bietet einen Aufnahmewinkel von nur 5°, was schnelles und präzises Anziehen ermöglicht.

1 Der feste Mund ermöglicht starkes Anziehen dank der hohen Länge des Schafts.

2 Der Umkehrer ist eingebaut, um unabsichtliches Umkehren zu vermeiden.



3 Das Zwölfkant-Auge ist um 15° geneigt, um die Hand zu schützen und eine bessere Zugänglichkeit zu ermöglichen.

4 Der Kopf mit festem Mund ist um 15° zur Achse geneigt, um den Aufnahmewinkel zu reduzieren.



142 Ring-Maulschlüssel mit Umschaltknarre



ISO 21982:2020

Ø mm	L mm	€	Hand	PC
6x6	136	19,90	3	001420006
7x7	136	19,90	3	001420007
8x8	136	20,60	3	001420008
9x9	143	22,10	3	001420009
10x10	159	22,60	3	001420010
11x11	168	23,40	3	001420011
12x12	174	24,20	3	001420012
13x13	180	26,00	3	001420013
14x14	190	27,00	2	001420014
15x15	200	28,50	2	001420015
16x16	216	31,00	2	001420016
17x17	233	32,00	2	001420017
18x18	239	34,00	2	001420018
19x19	248	34,00	2	001420019
21x21	285	44,00	1	001420021
22x22	285	46,50	1	001420022
24x24	325	53,50	1	001420024
27x27	355	77,50	1	001420027
30x30	420	91,00	1	001420030
32x32	420	94,50	1	001420032
34x34	482	132,00	1	001420034
36x36	482	133,00	1	001420036
38x38	482	135,50	1	001420038



142/B6	€ 172,50	1	001420066
8-10-13-14-17-19 mm			
142/BV6	10,10	1	001420076
142/B9	250,00	1	001420069
8-10-11-12-13-14-15-17-19 mm			
142/BV9	12,20	1	001420079



142/S15	€ 411,00	1	001420074
6-7-8-9-10-11-12-13 14-15-16-17-18-19-22 mm			
142/S17	565,00	1	001420068
6-7-8-10-11-12-13-14-15- 16-17-18-19-21-22-24-27 mm			
142/S19	728,00	1	001420075
6-7-8-9-10-11-12 13-14-15-16-17-18 19-22-24-27-30-32 mm			

142/SC9I-E

Ring-Maulschlüsselsatz, 9teilig, mit Umschaltknarre und kompakter Halterung



142/SC9I	€ 248,00	1	001420087
8-10-11-12-13-14-15-17-19 mm			
142/SCV9I	11,80	1	001420103
142/SC9E	257,00	1	001420088
8-10-11-12-13-16-17-18-19 mm			
142/SCV9E	11,80	1	001420104

142MC

Ring-Maulschlüssel mit Umschaltknarre, farbig



ISO 21982:2020

mm	L mm	€	U	U
8x8	136	21,70	3	001422008
10x10	159	23,70	3	001422010
11x11	168	24,30	3	001422011
12x12	174	25,50	3	001422012
13x13	180	27,00	3	001422013
14x14	190	28,50	2	001422014
15x15	200	29,50	2	001422015
16x16	216	33,00	2	001422016
17x17	233	33,50	2	001422017
18x18	239	35,00	2	001422018
19x19	248	36,50	2	001422019



142MC/SC9I	€ 259,00	1	001422087
8-10-11-12-13-14-15-17-19 mm			
142MC/SC9E	269,00	1	001422088
8-10-11-12-13-16-17-18-19 mm			

142AS

Ring-Maulschlüssel mit Umschaltknarre



mm	L mm	€	U	U
5/16x5/16	136	24,30	2	001420308
3/8x3/8	159	24,80	2	001420310
7/16x7/16	168	26,50	2	001420311
1/2x1/2	180	29,50	2	001420313
9/16x9/16	190	30,00	2	001420314
5/8x5/8	216	33,50	2	001420316
11/16x11/16	233	34,00	2	001420317
3/4x3/4	248	37,50	2	001420319



142AS/8	€ 240,00	1	001420330
5/16-3/8-7/16-1/2 9/16-5/8-11/16-3/4			

142C

Gerade und kurze Ring-Maulschlüssel mit Knarre



ISO 21982:2020

mm	L mm	€	U	U
8x8	88	14,90	2	001420108
9x9	96	14,90	2	001420109
10x10	96	15,50	2	001420110
11x11	100	16,50	2	001420111
12x12	104	17,50	2	001420112
13x13	108	18,30	2	001420113
14x14	114	19,00	2	001420114
15x15	118	19,70	2	001420115
16x16	122	20,30	2	001420116
17x17	128	22,10	2	001420117
18x18	132	23,70	2	001420118
19x19	138	24,30	2	001420119



142C/A12	€ 256,00	1	001420175
8-9-10-11-12-13-14 15-16-17-18-19 mm			

142SN

Ring-Maulschlüssel mit Knarre, gelenkig



ISO 21982:2020

mm	L mm	€	U	U
7x7	136	24,00	2	001420207
8x8	136	24,80	2	001420208
9x9	143	26,00	2	001420209
10x10	160	27,00	2	001420210
11x11	168	28,50	2	001420211
12x12	174	29,50	2	001420212
13x13	180	32,00	2	001420213
14x14	193	33,00	2	001420214
15x15	200	34,00	2	001420215
16x16	216	37,00	2	001420216
17x17	233	37,50	2	001420217
18x18	239	40,50	2	001420218
19x19	250	41,00	2	001420219
22x22	285	48,50	1	001420222
24x24	325	54,00	1	001420224



142SN/S13	€ 415,00	1	001420263
7-8-9-10-11-12-13-14 15-16-17-18-19 mm			



142SN/SC9	€ 297,00	1	001420259
8-10-11-12-13-14-15-17-19 mm			

186

Selbstspannender Schlüssel mit automatischem Wiederanzug für Sechskant von 8 bis 32 mm

Besonders geeignet für Schrauben mit Profilkopf: Sechskant, Spline, Vierkant, Torx(R); auch verschlissen.



L mm	€	Stk	Art-Nr
260	56,00	1	001860008

187

Ringschlüssel, ausbreitbar, mit Gelenk

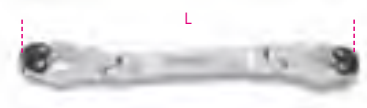

Ø mm	L mm	€	Stk	Art-Nr
8x9	125	38,50	1	001870008
10x11	155	41,50	1	001870010
12x13	175	43,00	1	001870012
14x15	205	47,00	1	001870014
16x17	235	53,00	1	001870016



Art-Nr	€	Stk	Art-Nr
187/B5 8x9-10x11-12x13 14x15-16x17 mm	235,00	1	001870050

188

Ringschlüssel mit Umschaltknarre, gerade, für die freien Riemenscheiben von Wechselstromgeneratoren



Ø mm	L mm	€	Stk	Art-Nr
10	240	25,50	2	001880010
15	322	35,00	2	001880015

192

Doppelringschlüssel mit Umschaltknarre, gerade, 4 in 1



Ø mm	L mm	€	Stk	Art-Nr
8x10/12x13	160	33,00	1	001920008
16x17/18x19	230	42,50	1	001920016

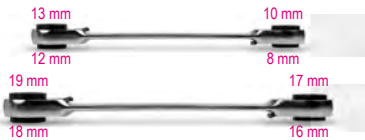

Art-Nr	€	Stk	Art-Nr
192/S2 8x10/12x13 mm 16x17/18x19 mm	75,00	1	001920070

194

Schlüssel mit Einsatzhalter, mit Umschaltknarre



Ø mm	L mm	€	Stk	Art-Nr
1/4x5/16	128	42,50	2	001940006

195

Doppelringschlüssel mit Knarre, gerade



Ø mm	L mm	€	Stk	Art-Nr
8x10	128	23,00	2	001950010
12x13	170	26,50	2	001950013
14x15	190	27,50	2	001950015
16x18	230	32,50	2	001950018
17x19	230	34,00	2	001950019



Art-Nr	€	Stk	Art-Nr
195/B5 8x10-12x13-14x15 16x18-17x19 mm	155,00	1	001950066
195/BV5	12,20	1	001950070

195AS

Ringschlüssel mit Knarre, gerade



Ø mm	L mm	€	Stk	Art-Nr
5/16x3/8	128	23,70	2	001950606
7/16x1/2	170	26,50	2	001950611
9/16x5/8	190	29,50	2	001950614
11/16x3/4	230	33,50	2	001950617



Art-Nr	€	Stk	Art-Nr
195AS/B4 5/16x3/8 - 7/16x1/2 - 9/16x5/8 - 11/16x3/4	125,00	1	001950654
195FTX/BV4	12,20	1	001950520

195P

Doppelringschlüssel, 15° Abwinkelung, mit Umschaltknarre



ISO 21982:2020

Ø mm	L mm	€	Stk	Art-Nr
8x10	128	34,00	2	001950210
12x13	170	37,00	2	001950213
14x15	190	38,00	2	001950215
16x18	230	42,50	2	001950218
17x19	230	44,00	2	001950219



Art-Nr	€	Stk	Art-Nr
195P/B5 8x10-12x13-14x15 16x18-17x19 mm	209,00	1	001950266
195/BV5	12,20	1	001950070

310

Schweißgeräte für Rohre und Fittings aus PE, PP, PVC und PVDF



Art-Nr	Ø mm	€	Stk	Art-Nr
310/2	16÷63	449,00	1	003100002

310B

Formen für Schweißgerät Art. 310



Ø mm	€	Stk	Art-Nr
16	76,50	1	003100016
20	84,00	1	003100020
25	90,00	1	003100025
32	99,50	1	003100032
40	118,00	1	003100040
50	149,00	1	003100050
63	171,00	1	003100063



310/C8

Schweißgerät mit Formensortiment,
7teilig



310/C8
310/2+310B: Ø 16-20-25
32-40-50-63

€ 1.007,00



1 003100108

440x270x120 mm - 7,7 kg

311

Heizschwerter zum geraden
und geneigten Handschweißen
von Rohren aus PE

CE



230V
50 Hz+60Hz

Schuko (CEE 7/7)

	Ø mm	Watt	€	Icon	Code
311/1	120	300	400,00	Icon	1 003110001
311/2	190	900	445,00	Icon	1 003110002



ANWENDUNGSBEREICH DER ROHRSCHEIDER BETA

Die Rohrschneider Beta decken einen sehr breiten Anwendungsbereich ab. Sie ermöglichen die Durchführung präziser und sauberer Schnitte an allen für die Rohre eingesetzten Materialien, dank der Präzision und Leichtgängigkeit der Rollen und des Schraub- oder Teleskopvorschubs.

In der nachstehenden Tabelle ist die Zuordnung zwischen Rohrschneider und Messer für jedes Material aufgeführt.

	STAHLGASROHRE			EDELSTAHLGASROHRE		
	10 mm 1/8"	60 mm 2"	115 mm 4"	10 mm 1/8"	60 mm 2"	115 mm 4"
330/2						
330/4						
				330/2+330R/12		
				330/4+330R/14		

	KUPFER- UND LEICHTMETALLROHRE							
	3 mm 1/8"	6 mm 1/4"	8 mm 5/16"	16 mm 5/8"	28 mm 1 1/8"	30 mm	38 mm 1 1/2"	67 mm 2 5/8"
332								
334								
336								
338								

	DÜNNWANDIGE ELDESTAHLROHRE							
	3 mm 1/8"	6 mm 1/4"	8 mm 5/16"	16 mm 5/8"	28 mm 1 1/8"	30 mm	38 mm 1 1/2"	67 mm 2 5/8"
332 + 334R/I								
334 + 334R/I								
336 + 338R/I								
338 + 338R/I								

	KUNSTSTOFFROHRE							
	6 mm 1/4"	8 mm 5/16"	16 mm 5/8"	30 mm 1 1/8"	38 mm 1 1/2"	50 mm 2"	67 mm 2 5/8"	127 mm 5"
336 + 338RP								
338 + 338RP								
339A								

330

Rohrschneider für Stahlrohre

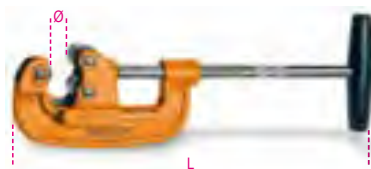

	Ø mm - "	L mm	€	Icon	Code
330/2	10÷60 1/8"÷2"	380	191,00	Icon	1 003300002
330/4	60÷115 2"÷4"	585	434,00	Icon	1 003300004

330R/A

Ersatzschneidradchen für Art. 330,
für Stahlrohre



	Ø mm	S mm	€	Icon	Code
330R/A2	32	7	18,30	Icon	1 003300012
330R/A4	42	9	47,50	Icon	1 003300014

330R/I

Ersatzschneidradchen für Art. 330,
für rostfreien Stahl



	Ø mm	S mm	€	Icon	Code
330R/I2	32	7	41,00	Icon	1 003300024
330R/I4	32	9	115,00	Icon	1 003300034

331C

C-förmiger Rohrschneider, im Taschenformat,
für Kupfer und Leichtmetalle



	Ø mm	L mm	€	Icon	Code
331C	15÷22	78	67,50	Icon	1 003310050

332

Minirohrschneider für Kupfer und Leichtmetalle



Ø mm - "	L mm	€		
3÷16 1/8"÷5/8"	59	27,50	2	003320001
3÷28 1/8"÷1"1/8"	63	30,50	2	003320003

334

Rohrschneider für Kupfer und Leichtmetalle



Ø mm - "	L mm	€		
3÷30 1/8"÷1"1/8"	150	38,00	1	003340001

334R

Ersatzschneidrädchen für Art. 332 und 334, für Kupfer und Leichtmetalle

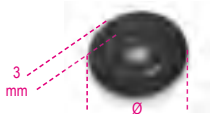

Ø mm	€		
334R 18	8,20	1	003340021

334R/I

Ersatzschneidrädchen für Art. 332 und 334, für rostfreien Stahl

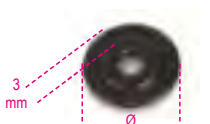

Ø mm	€		
334R/I 18	23,10	1	003340023

336

Rohrschneider mit Teleskopvorschub, für Kupfer und Leichtmetalle



Ø mm - "	L mm	€		
6÷38 1/4"÷1"1/2"	160	62,50	1	003360001

338

Rohrschneider mit schnellem Teleskopvorschub, für Kupfer, Leichtmetalle und Kunststoff



Ø mm - "	L mm	€		
6÷67 1/4"÷2"5/8"	290	156,00	1	003380001

338R

Ersatzschneidrädchen für Art. 331L, 336 und 338, für Kupfer und Leichtmetalle



Ø mm	€		
338R 18,5	8,70	1	003380022

338R/I

Ersatzschneidrädchen für Art. 336 und 338, für rostfreien Stahl



Ø mm	€		
338R/I 21,8	25,50	1	003380023

338RP

Ersatzschneidrädchen für Art. 336 und 338, für Kunststoff

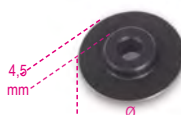

Ø mm	€		
338RP 21,9	9,40	1	003380025

339A

Rohrschneider mit schnellem Teleskopvorschub, für Kunststoffrohre



Ø mm - "	L mm	€		
50÷127 2"÷ 5"	345	333,00	1	003390011

339A/R

Ersatzschneidrädchen für Art. 339A

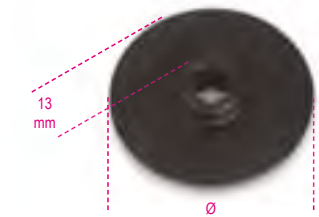

Ø mm	€		
339A/R 42	23,10	1	003390061

340

Rohrschere für mehrschichtige Rohre
Max. Ø 26 mm

PFTE-beschichtetes Messer
4 Stützrollen, um die Drehung des Rohrs während dem Schneidvorgang zu erleichtern
System zum Schneiden von Wellrohren, im Griff integriert

leichter Körper aus Magnesium



Ø max mm	€		
340 26	130,00	1	003400001

340RL

Ersatzschneidmesser für Art. 340



€		
340RL 37,00	1	003400010

340C

Wellrohrschere

- Schere aus Aluminiumlegierung und Magnesium
- Kompakt, klein und leicht
- Zusatzschneidmesser für Längsschnitte



Ø mm	L mm	€	U	M
14-45	134	61,50	1	003400050

340C/KRL

Kit 3 Ersatzschneidmesser für Art. 340C



340C/KRL	€	U	M
	37,00	1	003400055

341

Rohrschere für Kunststoffrohre



Ø mm	L mm	€	U	M
0÷25	190	46,50	1	003410001

341RL

Ersatzschneidmesser für Art. 341



341RL	€	U	M
	20,80	1	003410010

341B

Rohrschneider mit Rücklauf Sperre, für Kunststoffrohre



Ø mm	L mm	€	U	M
0÷35	195	85,00	1	003410051

341B/RM

Ersatzfeder für Art. 341B

341B/RM	€	U	M
	3,20	1	003410061

341B/RL

Ersatzschneidmesser für Art. 341B



341B/RL	€	U	M
	32,00	1	003410060

342

Rohrschneider mit Rücklauf Sperre, für Kunststoffrohre



Ø mm - "	L mm	€	U	M
0÷42 1"5/8	200	62,00	1	003420030

342MOL

Ersatzfeder für Art. 342

342MOL	€	U	M
	4,60	1	003420033

342RL

Ersatzschneidmesser für Art. 342

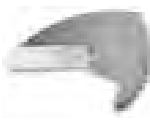

342RL	€	U	M
	28,50	1	003420032

342A

Rohrschneider mit Rücklauf Sperre, für Kunststoffrohre



Ø mm - "	L mm	€	U	M
0÷50 2"	270	127,00	1	003420101

342A/MOL

Ersatzfeder für Art. 342A

342A/MOL	€	U	M
	2,80	1	003420111

342A/RL

Ersatzschneidmesser für Art. 342A



342A/RL	€	U	M
	66,00	1	003420110

342P

Rohrschneider mit Rücklauf Sperre aus Magnesiumlegierung, für Kunststoffrohre



Ø mm - "	L mm	€	U	M
0÷50 2"	260	138,00	1	003420121

342P/RL

Ersatzschneidmesser für Art. 342P



342P/RL	€	U	M
	57,50	1	003420130



345

Innen-Außen-Entgrater,
Gehäuse aus Metall



Ø mm - "	L mm	€	5	003450001
3÷42 1/8"÷1"5/8	58	33,50	5	003450001

345U

Innen-Außen-Entgrater für Edelstahl,
Kupfer und Leichtlegierungen



Ø mm - "	L mm	€	1	003450050
4÷36 5/32÷1"7/16	60	88,00	1	003450050

345U/A

Adapter für Innen-Außen-Entgrater Art. 345U,
Sechskantanschluss 1/4", für Bohrmaschinen



L mm	€	3	003450055
90	22,50	3	003450055

345C

Kalibrator für Mehrschichtrohre



Ø mm	€	1	003450032
16-20-26-32	53,00	1	003450032

345SB

Entgrater mit drehbar gelagerter,
auswechselbarer Klinge



L mm	€	5	003450010
150	27,50	5	003450010

345SB/R

Ersatzklinge für Art. 345SB



345SB/R	€	3	003450015
	9,80	3	003450015

345SB2

Entgrater
mit fester Klinge



L mm	€	5	003450022
140	13,80	5	003450022

345SC

Bürste 4 in 1
für Innen- und Außendurchmesser
1/2" und 3/4"



L mm	L1 mm	L2 mm	€	2	003450060
195	28	32	16,10	2	003450060

345SI

Innen-Entgrater
mit drehbar gelagerter, auswechselbarer
Klinge



L mm	Ø mm	€	1	003450040
168	16,5	52,50	1	003450040

345SI/R

Ersatzklinge für Art. 345SI



345SI/R	€	1	003450045
	36,50	1	003450045

349

Bördelgerät mit Kupplung für Kupfer und
Leichtmetalle



Ø mm - "	€	1	003490001
6-8-10-12-14-15-16-18 (1/8-3/16-1/4-5/16 3/8-1/2-5/8-3/4)	331,00	1	003490001
270x200x50 mm - 2,7 kg			

349/SMM

Schlitten metrisch für Art. 349



Ø mm	€	1	003490011
6-8-10-12-14-15-16-18	97,00	1	003490011

349/SMAS

Schlitten in Zoll für Art. 349



Ø "	€	1	003490012
1/8-3/16-1/4-5/16 3/8-1/2-5/8-3/4	91,50	1	003490012

350

Bördelgerät für Kupfer und Leichtmetalle

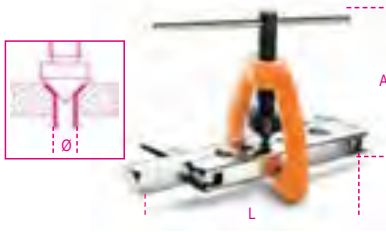

Ø mm	L mm	A mm	€	U	IT
4-4,75-6-8	175	104	96,00	1	003500001
10-12-14					

351C

Rohrschneider und Bördelgerät



351C	€	U	IT
	174,00	1	003510010

334	Ø 3÷30 mm (1/8"÷1"1/8)
350	Ø 4÷14 mm
351P	Ø 4-4,75-6-8-10-12-14 mm

225x150x45 mm - 1,6 kg

351P

Bördelgeräte für Bördelgerät Art. 350



351P	Ø mm	€	U	IT
351P 4	4	8,00	3	003510101
351P 4,75	4,75	8,00	3	003510102
351P 6	6	8,00	3	003510103
351P 8	8	8,00	3	003510104
351P 10	10	8,00	3	003510105
351P 12	12	8,00	3	003510106
351P 14	14	8,00	3	003510107

352U

Bördelgerät, einstellbar, für Kupfer und Leichtmetalle

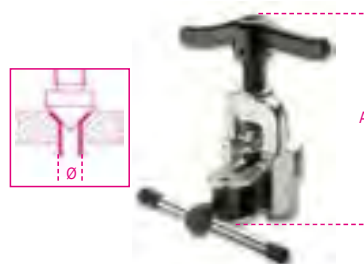

Ø mm - "	A mm	€	U	IT
5÷16	130	114,50	1	003520101
3/16÷5/8				

352C/U

Rohrschneider, Entgrater und Bördelgerät, einstellbar



352C/U	€	U	IT
	224,00	1	003520110

334	Ø 3÷30 mm (1/8"÷1"1/8)
345SB	
352U	Ø 5÷16 mm (3/16"÷5/8")

335x145x60 mm - 2120 g

355

Stufenschlüssel für Heizkörperventilnippeln, 5stufig



Ø "	L mm	€	U	IT
3/8"-1/2"	90	45,50	2	003550001
3/4"-1"				

357F3

Wasserwaage mit 3 Libellen für die Installation von Brauchwasseranschlüssen



Ø "	L mm	€	U	IT
3/8" / 1/2"	90÷220	144,00	1	003570100

357R/F3

Ersatzlibelle für Art. 357F3



357R/F3	€	U	IT
	23,20	1	003570101

358

Anschrageräte für Kunststoffrohre



	Ø mm	€	U	IT
358/1	16÷110	203,00	1	003580001
358/2	40÷250	203,00	1	003580002

358RL

Ersatzmesser für Art. 358/1 und 358/2



358RL	€	U	IT
	37,50	1	003580011

359

Universalschlüssel für Ausläufe



Ø "	L mm	A mm	€	U	IT
1"÷1"1/4	160	140	99,50	1	003590001

Beta

359CH

Kreuzadapter für Ausläufe Art. 359



∅	L	€		
mm	mm			
1 1/2	74	56,50	1	003590005

360

Rohrzangen, Modell "Stillson"



L	∅	∅	€		
mm	max"	max mm			
250	1" gas	34	41,50	1	003600025
350	1 1/2 gas	49	54,50	1	003600035
450	2" gas	60	76,50	1	003600045
600	2 1/2 gas	76	118,00	1	003600060
900	3 1/2 gas	102	326,00	1	003600090

360R/...

Ersatzteilkit für Art. 360
bestehend aus beweglicher Backe und Nutmutter.

	€		
360R 250	15,50	1	003600225
360R 350	21,30	1	003600235
360R 450	30,50	1	003600245
360R 600	44,50	1	003600260
360R 900	81,00	1	003600290

361N

Verstellbare Hebelrohrzange



L	∅	∅	€		
mm	max"	max mm			
350	1 1/2	49	85,50	1	003610014

362

Rohrzangen, amerikanisches Modell



L	∅	∅	€		
mm	max"	max mm			
200	1" gas	34	36,50	1	003620020
250	1 1/2 gas	49	45,50	1	003620025
300	2" gas	60	54,50	1	003620030
350	2" gas	60	65,50	1	003620035
450	2 1/2 gas	76	94,50	1	003620045
600	3" gas	90	144,00	1	003620060
900	5" gas	140	176,00	1	003620090

362R/...

Ersatzteilkit für Art. 362
bestehend aus: fester Backe; beweglicher Backe; Nutmutter; Befestigungsstift.

	€		
362R 200	7,70	1	003620220
362R 225	10,90	1	003620225
362R 300	13,40	1	003620230
362R 350	15,50	1	003620235
362R 450	21,10	1	003620245
362R 600	28,00	1	003620260
362R 900	70,50	1	003620290

363

Rohrzangen, amerikanisches Modell,
aus Leichtmetall



L	∅	∅	€		
mm	max"	max mm			
350	2" gas	60	78,50	1	003630035
450	2 1/2 gas	76	106,50	1	003630045
600	3" gas	90	180,00	1	003630060
900	5" gas	140	337,00	1	003630090
1200	6" gas	165	357,00	1	003630120

363R/...

Ersatzteilkit für Art. 363
bestehend aus: fester Backe; beweglicher Backe; Nutmutter; Befestigungsstift.

	€		
363R 350	17,00	1	003630235
363R 450	22,60	1	003630245
363R 600	31,50	1	003630260
363R 900	61,50	1	003630290
363R 1200	95,00	1	003630320

365

Rohrzangen, Modell Vorngreifer,
aus Leichtmetall



L	∅	∅	€		
mm	max"	max mm			
350	2" gas	60	98,00	1	003650035
450	2 1/2 gas	76	135,00	1	003650045

365R/...

Ersatzteilkit für Art. 365
bestehend aus: fester Backe; beweglicher Backe; Nutmutter; Befestigungsstift.

	€		
365R 350	73,50	1	003650235
365R 450	110,00	1	003650245

366

Rohrzangen, leichte Ausführung



L	∅	∅	€		
mm	max"	max mm			
175	1" gas	34	37,50	1	003660017
225	1 1/2 gas	49	44,00	1	003660022
275	2" gas	60	53,50	1	003660027
300	2 1/2 gas	76	57,50	1	003660030
350	3" gas	90	65,50	1	003660035

374

Rohrzangen, schwedisches Modell
schmale Backen 45° gebogen



DIN 5234

L	∅	∅	€		
mm	max"	max mm			
240	1 1/2" gas	21	43,00	1	003740024
320	1" gas	34	57,50	1	003740032
410	1 1/2 gas	49	76,00	1	003740041
550	2" gas	60	119,00	1	003740055
630	3" gas	90	212,00	1	003740063

375

Rohrzange, schwedisches Modell,
parallele Backen 45° gebogen



DIN 5234

L	∅	∅	€		
mm	max"	max mm			
320	1" gas	34	57,50	1	003750032
410	1 1/2 gas	49	76,00	1	003750041
550	2" gas	60	119,00	1	003750055

376

Rohrzangen, schwedisches Modell
Backen 90° gebogen



DIN 5234

L	∅	∅	€		
mm	max"	max mm			
320	1" gas	34	57,50	1	003760032
410	1 1/2 gas	49	76,00	1	003760041
550	2" gas	60	119,00	1	003760055
630	3" gas	90	216,00	1	003760063

378

Rohrzangen, schwedisches Modell
schmale Backen 45° gebogen



DIN 5234

L mm	Ø max " gas	Ø max mm	€	🔧	📦
250	1/2"	21	45,50	1	003780025
320	1" gas	34	61,00	1	003780032
410	1 1/2" gas	49	78,50	1	003780041
550	2" gas	60	130,00	1	003780055
650	3" gas	90	218,50	1	003780065

374R/...

Komplettes Ersatzteilkit für Art. 374 - 375 - 376
- 378

bestehend aus Nutmutter und Nutmuttersteller

	€	🔧	📦
374R 240 x 374/240-378/250	2,60	1	003740724
374R 320 x 374/320-376/320-378/320	2,90	1	003740732
374R 410 x 374/410-375/410-376/410-378/410	3,60	1	003740741
374R 550 x 374/550-376/550-378/550	4,30	1	003740755
374R 630 x 374/630-378/650	6,50	1	003740763

383

Gurtrohrrzangen



	Ø max " gas	Ø max mm	L mm	€	🔧	📦
383/1	3"	90	300	62,00	1	003830001
383/2	8" gas	220	300	65,50	1	003830002

383R

Ersatzgurte für Art. 383



	S mm	€	🔧	📦
383R/1	27	25,00	1	003830010
383R/2	27	26,50	1	003830015

384

Kettenrohrrzange



	Ø max " gas	Ø max mm	L mm	€	🔧	📦
384	4" gas	115	300	84,00	1	003840032

384RC

Ersatzkette für Art. 384



	€	🔧	📦
384RC	52,00	1	003840033

386A

Kettenrohrrzangen, schwere Ausführung



	Ø max gas	L mm	€	🔧	📦
386A/1	4" gas 115 mm	900	285,00	1	003860001
386A/2	6" gas 168 mm	900	528,00	1	003860002
386A/5	8" gas 220 mm	1100	679,00	1	003860005
386A/6	12" gas 324 mm	1300	1.178,00	1	003860006

386A/RC

Ersatzketten für Art. 386A



	€	🔧	📦
386A1/RC	89,00	1	003860011
386A2/RC	127,00	1	003860012
386A5/RC	168,00	1	003860015
386A6/RC	295,00	1	003860016



387

Rohrbiegezeuge für Rohre aus Kupfer und
Nichteisenmetallen
mit auswechselbaren Bügeln
3/16"-1/4"-5/16"-3/8"



L mm	Ø mm	€	🔧	📦
255	3/16"-1/4"-5/16"-3/8"	56,50	1	003870001

387R

Ersatzbügel für Art. 387



Ø	€	🔧	📦
3/16"-1/4"	14,30	1	003870010
5/16"-3/8"	15,10	1	003870015

388

Rohrbiegezeugen für dünnwandige Rohre
aus Kupfer, Leichtmetall und Weichstahl

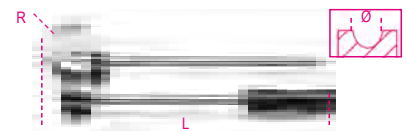

Ø mm	L mm	R mm	€	🔧	📦
6	305	18,0	71,00	1	003880006
8	315	23,5	76,50	1	003880008
10	350	31,0	88,00	1	003880010
12	360	31,0	94,00	1	003880012
14	455	46,5	122,00	1	003880014
15	465	46,5	130,00	1	003880015
16	465	46,5	140,00	1	003880016

388A

Rohrbiegezeugen für dünnwandige
Rohre aus Kupfer und Leichtmetall



	Ø mm	L mm	€	🔧	📦
388A/1	6-8-10 mm	220	77,00	1	003880051
388A/2	1/4"-5/16"-3/8"	220	77,00	1	003880055

388C/C8

Rohrbiegezeuge mit 7 Bügeln
für Rohre aus Kupfer und Leichtmetall



Ø mm	€	Stk	Art-Nr
10-12-14-16 18-20-22	562,00	1	003880200

400x330x110 mm - 3,6 kg

389/K4

Kit Rohrbiegefedern
für Kupferrohre,
für den Aussengebrauch



Ø"	L mm	€	Stk	Art-Nr
1/4-3/8-1/2-5/8	290	23,80	1	003890001

392C

"Connector"-Zange



Ø mm	L mm	€	Stk	Art-Nr
25+65	260	53,00	1	003920100

392RG/C

Ersatzbackenschutz für Art. 392C, 1 Paar



€	Stk	Art-Nr
7,40	1	003920101



393

Hahnmutternzange



L mm	€	Stk	Art-Nr
270	77,00	1	003930001

395

Standhahnmutternschlüssel



Ø mm	L mm	€	Stk	Art-Nr
15+32 mm 5/8"±1"1/4	240	51,00	1	003950001

395T

Standhahnmutternschlüssel,
teleskopisch



Ø mm	L mm	€	Stk	Art-Nr
10+32 mm 3/8"±1"1/4	250+430	68,00	1	003950100

398

Kettenschraubstöcke



Ø mm	L mm	€	Stk	Art-Nr
1/2+8"	250	351,00	1	003980008

399

Windeisen mit Innenvierkant,
für Radiator-Nippelschlüssel 396A

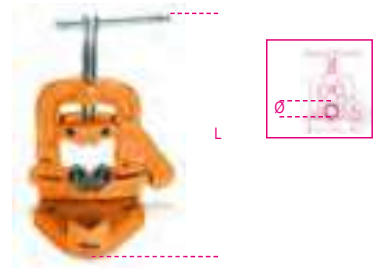

Ø mm	L min mm	€	Stk	Art-Nr
10+60 mm 1/8+2"	220	216,00	1	003990005
10+89 mm 1/8+3"	290	388,00	1	003990010

399R/...

Ersatzteilkit für 399
bestehend aus 2 unteren Backen und 1
oberen Backen



€	Stk	Art-Nr
27,50	1	003990105
44,50	1	003990110



TABELLE FÜR METALLSPIRALBOHRER

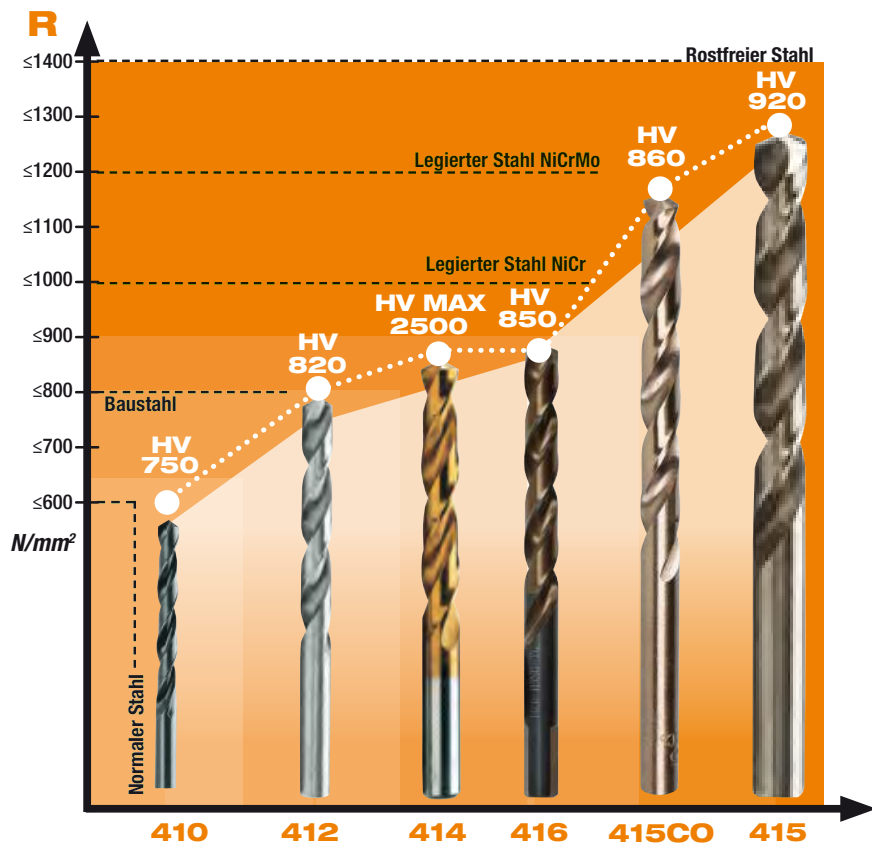

R N/mm² - Mechanische Belastbarkeit des Bohrmaterials.

HV - Härte-Vickers, Härte des Bohrers nach Vickersskala: je höher der Wert, desto höher die Härte.

LEITFADEN FÜR ZYLINDRISCHE SPIRALBOHRER

Rollgewalzte Spiralbohrer - Durch Warmwalzen hergestellte Bohrer. Gute Qualität für nichtintensive Einsätze wie Bohren von Eisen, Flussstahl, Leichtlegierungen, und nicht eisenhaltige Metalle im Allgemeinen.

Geschliffene Bohrer - Bohrer, die gänzlich durch Schleifen aus einer wärmebehandelten Stahlstange realisiert werden. Hohe Leistungen für das Bohren von Stählen und Leichtlegierungen: Konstante Leistung, optimale Spanentfernung und Präzision der Bohrlöcher.

HSS - Hochgeschwindigkeitsstahl (high speed steel) hat eine hohe Härte und gute Beständigkeit gegen hohe Temperaturen; es ist das beste Material für die Herstellung von Schneidwerkzeugen und von Werkzeugen zum Gewindebohren und Gewindeschneiden.

Kobalt (Co) - Legierungsbestandteil zur Erhöhung der Warmfestigkeit des Stahls, wodurch der Verschleiß der Spitze sich auch bei hohen Temperaturen verringert. Umso größer der Kobaltanteil ist, desto besser sind die Leistungen des Werkzeugs. Normalerweise werden Legierungen mit Kobaltwerten von 5% und 8% verwendet.

HSS-Co - Superschneller Stahl mit Kobaltanteil von 5% oder 8%.

TiN - Feinste Titanitridbeschichtung. Dank der hohen Härte und des niedrigen Reibungskoeffizienten werden die Verschleißfestigkeit und die Korrosionsbeständigkeit erhöht. Verbessert zudem das Gleiten des bei der Bearbeitung sich bildenden Spans.

Chromstahl - Die aus Chromstahl realisierten Werkzeuge eignen sich für die manuelle Verwendung beim Gewindebohren an Eisen, Leichtlegierungen, nicht behandelten oder wärmebehandelten Stählen mit niedriger Härte. Anwendung bei der Reinigung und Wiederherstellung von beschädigten Gewinden in allen Berufssparten und insbesondere in der Automotivebranche.

Hartmetall - Hoch verschleißfestes Material, das bei den Plättchen der Maurerbohrer verwendet wird.

Spitzenwinkel 118° - Standard-Spitzenwinkel für Metallbohrer. Ermöglicht ein schnelles Eindringen in die Metalle und erleichtert so das Anbohren. Optimale Wärmeableitung.

Spitzenwinkel 130° - Weiter Spitzenwinkel, bietet eine höhere Präzision beim Anbohren und benötigt eine geringere Eindringungskraft.

Doppelspitzenwinkel 115°/135° - Kombiniert die Vorteile beider Winkel und fügt so eine Spanbrechfunktion hinzu; aus diesem Grund die beste Wahl für Materialien mit langem Span.

SDS-Plus - Schneller und sicherer Schaft für Bohrhammer.

410

Spiralbohrer, zylindrisch, kurze Ausführung, aus HSS, gewalzt

R ≤ 650 N/mm²
HV ~ 750+820



DIN 338 ISO 235

Ø mm	L mm	L1 mm	€	U	U
0,50	22	6	1,90	10	004100030
1,00	34	12	1,20	10	004100040
1,25	38	16	0,90	10	004100043
1,50	40	18	0,80	10	004100046
1,75	46	22	0,80	10	004100049
2,00	49	24	0,80	10	004100052
2,25	53	27	0,90	10	004100055
2,50	57	30	0,80	10	004100058
2,75	61	33	0,90	10	004100061
3,00	61	33	0,80	10	004100064
3,20	65	36	1,20	10	004100066
3,25	65	36	1,20	10	004100067
3,50	70	39	1,05	10	004100070
3,75	70	39	1,30	10	004100073
4,00	75	43	1,30	10	004100076
4,20	75	43	1,50	10	004100078
4,25	75	43	1,50	10	004100079
4,50	80	47	1,40	10	004100082
4,75	80	47	1,50	10	004100085
5,00	86	52	1,50	10	004100088
5,25	86	52	2,10	10	004100091
5,50	93	57	1,90	10	004100094
5,75	93	57	2,10	10	004100097
6,00	93	57	1,90	10	004100100
6,25	101	63	2,50	10	004100103
6,50	101	63	2,30	10	004100106
6,75	109	69	2,90	10	004100109
7,00	109	69	2,70	10	004100112
7,50	109	69	2,80	10	004100118
8,00	117	75	3,40	10	004100124
8,50	117	75	3,60	10	004100130
9,00	125	81	4,30	5	004100136
9,50	125	81	4,70	5	004100142
10,00	133	87	5,20	5	004100148
10,50	133	87	6,20	5	004100172
11,00	142	94	7,30	5	004100184
11,50	142	94	7,60	5	004100196
12,00	151	101	8,40	5	004100210
12,50	151	101	9,20	5	004100222
13,00	151	101	9,70	5	004100234
14,00	160	108	12,80	5	004100242
15,00	169	114	14,90	5	004100250
16,00	178	120	18,60	5	004100258
17,00	184	125	20,50	3	004100262
18,00	191	130	24,30	3	004100266
19,00	198	135	27,50	3	004100270
20,00	205	140	33,00	3	004100274



	€	U	U
410/SP19 Ø 1÷10 x 0,5 mm	53,00	1	004100419
410/SPVP1	29,50	1	004100421
410/SP25 Ø 1÷13 x 0,5 mm	112,00	1	004100425
410/SPVP2	41,00	1	004100427



410/SEL19 € 41,50 1 004100418
 Ø 1÷10 x 0,5 mm

410MIX/SEL19

Satz mit 13 Spiralbohrern Art. 410
 und 6 Spiralbohrern mit Hartmetalleinsatz



410MIX/SEL19 € 41,50 1 004100417



Ø 1 - 1,5 - 2 - 2,5 - 3 - 3,5 - 4
 4,5 - 5 - 5,5 - 6 - 8 - 10 mm
 Ø 4 - 5 - 6 - 8 - 9 - 10 mm

410A

Spiralbohrer, zylindrisch,
 kurze Ausführung, aus HSS, gewalzt,
 mit verkürztem Schaft

R ≤ 650 N/mm²
 HV ~ 750+820



DIN 338 ISO 235

Ø mm	L mm	L1 mm	€	1	004100281
13,50	160	108	15,00	5	004100281
14,00	160	108	15,00	5	004100283
14,50	169	114	17,50	5	004100285
15,00	169	114	17,50	5	004100287
15,50	178	120	21,60	5	004100289
16,00	178	120	21,60	5	004100291
16,50	184	125	22,70	3	004100292
17,00	184	125	22,70	3	004100293
17,50	191	130	27,00	3	004100294
18,00	191	130	27,00	3	004100295
18,50	198	135	30,00	3	004100296
19,00	198	135	30,00	3	004100297
19,50	205	140	35,00	3	004100298
20,00	205	140	35,00	3	004100299



410AS

Spiralbohrer, zylindrisch,
 kurze Ausführung, aus HSS,
 gewalzt,
 in Zoll

R ≤ 650 N/mm²
 HV 750+820



ANSI B94

Ø "	L mm	L1 mm	€	10	004100371
1/16	48	22	0,80	10	004100371
5/64	51	25	0,80	10	004100372
3/32	57	32	0,90	10	004100373
7/64	67	38	1,05	10	004100374
1/8	70	41	1,30	10	004100375
9/64	73	44	1,30	10	004100376
5/32	79	51	1,40	10	004100377
11/64	83	54	1,50	10	004100378
3/16	89	59	1,70	10	004100379
13/64	92	62	1,80	10	004100380
7/32	95	64	1,90	10	004100381
15/64	98	67	2,30	10	004100382
1/4	102	70	2,50	10	004100383
17/64	105	73	2,90	10	004100384
9/32	108	75	3,30	10	004100385
19/64	111	78	3,60	10	004100386
5/16	114	81	4,60	10	004100387
21/64	117	84	4,70	10	004100388
11/32	121	87	5,50	5	004100389
23/64	124	89	5,70	5	004100390
3/8	127	92	5,90	5	004100391



410AS/SP21 € 80,00 1 004100429
 Ø 1/16-5/64-3/32-7/64
 1/8-9/64-5/32-11/64-3/16
 13/64-7/32-15/64-1/4
 17/64-9/32-19/64-5/16
 21/64-11/32-23/64-3/8

410AS/SPV1 € 30,00 1 004100430



410AS/SEL21 € 63,50 1 004100433
 Ø 1/16-5/64-3/32-7/64
 1/8-9/64-5/32-11/64-3/16
 13/64-7/32-15/64-1/4
 17/64-9/32-19/64-5/16
 21/64-11/32-23/64-3/8

412

Spiralbohrer, zylindrisch,
 kurze Ausführung, aus HSS,
 vollständig geschliffen, poliert

R ≤ 800 N/mm²
 HV ~ 750+820



DIN 338 ISO 235

Ø mm	L mm	L1 mm	€	10	004120030
0,50	22	6	3,30	10	004120030
1,00	34	12	2,20	10	004120040
1,25	38	16	2,30	10	004120043
1,50	40	18	1,90	10	004120046
1,75	46	22	1,90	10	004120049
2,00	49	24	1,70	10	004120052
2,25	53	27	2,10	10	004120055
2,50	57	30	1,80	10	004120058
2,75	61	33	2,10	10	004120061
3,00	61	33	1,90	10	004120064
3,25	65	36	2,40	10	004120067
3,50	70	39	2,30	10	004120070
3,75	70	39	2,60	10	004120073
4,00	75	43	2,40	10	004120076
4,25	75	43	3,10	10	004120079
4,50	80	47	2,80	10	004120082
4,75	80	47	3,30	10	004120085
5,00	86	52	3,10	10	004120088
5,25	86	52	4,40	10	004120091
5,50	93	57	4,10	10	004120094
5,75	93	57	4,90	10	004120097
6,00	93	57	4,30	10	004120100
6,25	101	63	6,00	10	004120103
6,50	101	63	5,30	10	004120106
6,75	109	69	6,70	10	004120109
7,00	109	69	6,20	10	004120112
7,25	109	69	7,50	5	004120115
7,50	109	69	6,40	5	004120118
7,75	117	75	8,50	5	004120121
8,00	117	75	7,90	5	004120124
8,25	117	75	9,50	5	004120127
8,50	117	75	9,60	5	004120130
8,75	125	81	10,60	5	004120133
9,00	125	81	10,00	5	004120136
9,25	125	81	11,60	5	004120139
9,50	125	81	10,50	5	004120142
9,75	133	87	12,90	5	004120145
10,00	133	87	11,60	5	004120148
10,25	133	87	17,60	5	004120149
10,50	133	87	15,50	5	004120150
10,75	142	94	21,00	5	004120151
11,00	142	94	18,50	5	004120152
11,25	142	94	22,40	5	004120153
11,50	142	94	19,50	5	004120154
11,75	142	94	24,30	5	004120155
12,00	151	101	21,40	5	004120156
12,25	151	101	26,00	5	004120157
12,50	151	101	22,80	5	004120158
12,75	151	101	30,00	5	004120159
13,00	151	101	24,20	5	004120160



412/SP19 € 106,00 1 004120419
 Ø 1÷10 x 0,5 mm

410/SPVP1 € 29,50 1 004100421

412/SP25 € 219,00 1 004120425
 Ø 1÷13 x 0,5 mm

410/SPVP2 € 41,00 1 004100427

412/SP49 € 525,00 1 004120449
 Ø 1÷13 x 0,25 mm

412/SPV4 € 125,00 1 004120451

412/C150



412/C150 € 639,00 1 004120450

412 Ø 3 mm n. 20
 Ø 1-1,5-2-2,5-3-3,5-4-4,5-5 mm 10
 Ø 5,5-6-6,5-7-7,5-8-8,5-9-9,5-10 mm 5

365x230x47 mm - 3,3 kg



412/SP91 € 681,00 1 004120452
 Ø 1÷10 x 0,10 mm

412A

Spiralbohrer, zylindrisch,
 kurze Ausführung, aus HSS
 vollständig geschliffen, brüniert,
 mit verkürztem Schaft

R ≤ 800 N/mm²
 HV ~ 750÷820

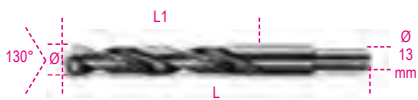

DIN 338 ISO 235

Ø mm	L mm	L1 mm	€	U	PC
13,50	160	108	39,00	3	004120202
14,00	160	108	40,00	3	004120204
14,50	169	114	43,50	3	004120206
15,00	169	114	45,00	3	004120208
15,50	178	120	52,00	3	004120210
16,00	178	120	53,50	3	004120212
16,50	184	125	55,50	1	004120213
17,00	184	125	59,00	1	004120214
17,50	191	130	63,00	1	004120215
18,00	191	130	67,00	1	004120216
18,50	198	135	72,00	1	004120217
19,00	198	135	74,50	1	004120218
19,50	205	140	83,00	1	004120219
20,00	205	140	85,00	1	004120220

412L

Spiralbohrer, zylindrisch,
 lange Ausführung, aus HSS,
 vollständig geschliffen, brüniert

R ≤ 800 N/mm²
 HV ~ 750÷820



DIN 340

Ø mm	L mm	L1 mm	€	U	PC
2,00	85	56	4,30	10	004120232
2,50	95	62	4,60	10	004120234
3,00	100	66	4,90	10	004120236
3,50	112	73	5,50	10	004120238
4,00	119	78	6,00	10	004120240
4,50	126	82	7,30	10	004120242
5,00	132	87	7,50	10	004120244
5,50	139	91	9,50	10	004120246
6,00	139	91	10,20	10	004120248
6,50	148	97	12,10	5	004120250
7,00	156	102	14,10	5	004120252
8,00	165	109	18,80	5	004120256
9,00	175	115	22,20	5	004120260
10,00	184	121	24,30	5	004120264

412XL

Spiralbohrer, zylindrisch,
 extralange Ausführung, aus HSS,
 vollständig geschliffen

R ≤ 800 N/mm²
 HV ~ 750÷820



DIN 1869/1

Ø mm	L mm	L1 mm	€	U	PC
3,00	150	100	16,40	1	004120520
3,50	165	115	18,00	1	004120522
4,00	175	120	18,00	1	004120524
4,50	185	125	18,60	1	004120526
5,00	195	135	18,60	1	004120528
5,50	205	140	22,80	1	004120530
6,00	205	140	22,80	1	004120532
6,50	215	150	27,00	1	004120534
7,00	225	155	31,50	1	004120536
7,50	225	155	36,50	1	004120538
8,00	240	165	38,50	1	004120540
8,50	240	165	40,00	1	004120542
9,00	250	175	51,50	1	004120544
9,50	250	175	55,50	1	004120546
10,00	265	185	55,50	1	004120548
10,50	265	185	55,50	1	004120550
11,00	280	195	55,50	1	004120552
12,00	295	205	70,50	1	004120556
13,00	295	205	73,00	1	004120560



414

Spiralbohrer, zylindrisch,
 kurze Ausführung, aus HSS-TiN,
 vollständig geschliffen

R ≤ 900 N/mm²
 HV 0,05 ~ 2500



DIN 338 ISO 235

Ø mm	L mm	L1 mm	€	U	PC
1,00	34	12	2,80	10	004140040
1,25	38	16	3,30	10	004140042
1,50	40	18	2,60	10	004140046
1,75	46	22	3,30	10	004140048
2,00	49	24	2,70	10	004140052
2,25	53	27	3,40	10	004140054
2,50	57	30	2,80	10	004140058
2,75	61	33	3,90	10	004140060
3,00	61	33	3,20	10	004140064
3,25	65	36	4,20	10	004140066
3,50	70	39	3,90	10	004140070
3,75	70	39	4,40	10	004140072
4,00	75	43	3,90	10	004140076
4,25	75	43	4,70	10	004140078
4,50	80	47	4,30	10	004140082
4,75	80	47	5,40	10	004140084
5,00	86	52	5,00	10	004140088
5,25	86	52	6,90	10	004140090
5,50	93	57	6,00	10	004140094
5,75	93	57	7,30	10	004140096
6,00	93	57	6,70	10	004140100
6,25	101	63	8,40	10	004140102
6,50	101	63	7,40	10	004140106
6,75	109	69	10,00	10	004140108
7,00	109	69	8,10	10	004140112
7,25	109	69	11,10	5	004140114
7,50	109	69	9,90	5	004140118
7,75	117	75	12,90	5	004140120
8,00	117	75	11,60	5	004140124
8,25	117	75	13,40	5	004140125
8,50	117	75	12,00	5	004140130
8,75	125	81	16,70	5	004140132
9,00	125	81	14,90	5	004140136
9,25	125	81	19,00	5	004140138
9,50	125	81	16,70	5	004140142
9,75	133	87	19,90	5	004140144
10,00	133	87	17,70	5	004140148
10,50	133	87	20,70	5	004140150
11,00	142	94	22,40	5	004140152
11,50	142	94	24,30	5	004140154
12,00	151	101	25,50	5	004140156
12,50	151	101	30,00	5	004140158
13,00	151	101	31,50	5	004140160



414/SP19	€ 155,00	1	004140419
Ø 1÷10 x 0,5 mm			
410/SPVP1	€ 29,50	1	004100421
414/SP25	€ 313,00	1	004140425
Ø 1÷13 x 0,5 mm			
410/SPVP2	€ 41,00	1	004100427
414/SP49	€ 688,00	1	004140429
Ø 1÷13 x 0,25 mm			
414/SPV4	€ 125,00	1	004140430

414/C116



414/C116 € 630,00 1 004140450

414	Ø 1 - 1,5 - 2 - 2,5 - 3 - 3,5 - 4 - 4,5 - 5 mm	n.
	Ø 5,5 - 6 - 6,5 - 7 - 7,5 - 8 mm	3
	Ø 8,5 - 9 - 9,5 - 10 mm	2

365x230x47 mm - 2,7 Kg

415

Spiralbohrer, zylindrisch, kurze Ausführung, aus HSS-Co 8%, vollständig geschliffen

R ≤ 1400 N/mm²
HV ~ 850+920



DIN 338 ISO 235

Ø mm	L mm	L1 mm	€	Hand	Machine
0,50	22	6	8,10	10	004150029
1,00	34	12	4,10	10	004150040
1,25	38	16	4,50	10	004150043
1,50	40	18	4,10	10	004150046
1,75	46	22	4,30	10	004150049
2,00	49	24	3,90	10	004150052
2,25	53	27	4,70	10	004150055
2,50	57	30	4,40	10	004150058
2,75	61	33	4,70	10	004150061
3,00	61	33	4,40	10	004150064
3,25	65	36	6,00	10	004150067
3,50	70	39	5,50	10	004150070
3,75	70	39	6,70	10	004150073
4,00	75	43	6,00	10	004150076
4,25	75	43	7,40	10	004150079
4,50	80	47	6,70	10	004150082
4,75	80	47	7,80	10	004150085
5,00	86	52	7,30	10	004150088
5,25	86	52	10,50	10	004150091
5,50	93	57	9,50	10	004150094
5,75	93	57	11,00	10	004150097
6,00	93	57	10,00	10	004150100
6,25	101	63	14,10	10	004150103
6,50	101	63	12,40	10	004150106
6,75	109	69	16,20	10	004150109
7,00	109	69	14,60	10	004150112
7,25	109	69	17,60	5	004150115
7,50	109	69	15,80	5	004150118
7,75	117	75	20,60	5	004150121
8,00	117	75	18,60	5	004150124
8,25	117	75	22,40	5	004150127
8,50	117	75	21,00	5	004150130
8,75	125	81	27,50	5	004150133
9,00	125	81	24,50	5	004150136
9,25	125	81	29,00	5	004150139
9,50	125	81	26,50	5	004150142
9,75	133	87	31,50	5	004150145
10,00	133	87	28,50	5	004150148
10,25	133	87	37,50	5	004150149
10,50	133	87	32,00	5	004150150
10,75	142	94	41,50	5	004150151
11,00	142	94	37,50	5	004150152
11,25	142	94	46,50	5	004150153
11,50	142	94	41,00	5	004150154
11,75	142	94	47,50	5	004150155

Ø mm	L mm	L1 mm	€	Hand	Machine
12,00	151	101	44,50	5	004150156
12,25	151	101	56,50	5	004150157
12,50	151	101	47,50	5	004150158
12,75	151	101	62,00	5	004150159
13,00	151	101	51,00	5	004150160
14,00	160	108	89,50	3	004150164
15,00	169	114	106,00	3	004150168
16,00	178	120	130,00	3	004150172
17,00	186	125	148,00	1	004150174
18,00	194	130	164,00	1	004150176
19,00	202	135	189,00	1	004150178
20,00	210	140	212,00	1	004150180



Co8%

415/SP19	€	Hand	Machine
Ø 1÷10 x 0,5 mm	218,00	1	004150419
410/SPVP1	29,50	1	004100421
415/SP25	451,00	1	004150425
Ø 1÷13 x 0,5 mm			
410/SPVP2	41,00	1	004100427
415/SP49	1.119,00	1	004150431
Ø 1÷13 x 0,25 mm			
415/SPV4	125,00	1	004150432

415/C116



415/C116 € 950,00 1 004150450

415	Ø 1 - 1,5 - 2 - 2,5 - 3 - 3,5 - 4 - 4,5 - 5 mm	n.
	Ø 5,5 - 6 - 6,5 - 7 - 7,5 - 8 mm	3
	Ø 8,5 - 9 - 9,5 - 10 mm	2

365x230x47 mm - 2,7 kg



415/SP91 € 1.305,00 1 004150460
Ø 1÷10 x 0,10 mm

415CO

Spiralbohrer, zylindrisch, kurze Ausführung, aus HSS-Co 5%, vollständig geschliffen

R ≤ 1200 N/mm²
HV ~ 800+860



DIN 338 ISO 235

Ø mm	L mm	L1 mm	€	Hand	Machine
1,00	34	12	2,10	10	004150310
1,50	40	18	2,10	10	004150312
2,00	49	24	2,10	10	004150314
2,50	57	30	2,20	10	004150316
3,00	61	33	2,20	10	004150320
3,50	70	39	2,60	10	004150322
4,00	75	43	3,10	10	004150324
4,50	80	47	3,60	10	004150326
5,00	86	52	3,70	10	004150328
5,50	93	57	4,70	10	004150330
6,00	93	57	5,10	10	004150332
6,50	101	63	6,10	10	004150334
7,00	109	69	7,50	10	004150336
7,50	109	69	8,20	5	004150338
8,00	117	75	9,60	5	004150340
8,50	117	75	10,00	5	004150342
9,00	125	81	12,30	5	004150344
9,50	125	81	12,90	5	004150346
10,00	133	87	14,90	5	004150348
10,50	133	87	18,00	5	004150350
11,00	142	94	19,90	5	004150352
11,50	142	94	21,90	5	004150354
12,00	151	101	23,90	5	004150356
12,50	151	101	26,00	5	004150358
13,00	151	101	28,50	5	004150360

415CO-A

Spiralbohrer, zylindrisch, kurze Ausführung, aus HSS-Co 5%, vollständig geschliffen

R ≤ 1200 N/mm²
HV ~ 800+860



DIN 338

Ø mm	L mm	L1 mm	€	Hand	Machine
14,00	160	108	55,50	3	004150364
15,00	169	114	63,50	3	004150366
16,00	178	120	77,00	3	004150368
17,00	184	125	78,50	1	004150370
18,00	191	130	102,00	1	004150372
19,00	198	135	117,00	1	004150374
20,00	205	140	135,00	1	004150376



DIN 338

415CO/SP19	€	Hand	Machine
Ø 1÷10 x 0,5 mm	115,00	1	004150421
410/SPVP1	29,50	1	004100421

415L

Spiralbohrer, zylindrisch, lange Ausführung, aus HSS-CO 5% vollständig geschliffen

R ≤ 1200 N/mm²
HV ~ 800÷860



DIN 340

Ø mm	L mm	L1 mm	€	🔧	📦
3,00	100	66	5,50	10	004150236
3,50	112	73	6,10	10	004150238
4,00	119	78	7,50	10	004150240
4,50	126	82	9,20	10	004150242
5,00	132	87	9,50	10	004150244
5,50	139	91	11,80	10	004150246
6,00	139	91	12,90	10	004150248
6,50	148	97	15,10	5	004150250
7,00	156	102	18,00	5	004150252
8,00	165	109	22,80	5	004150256
9,00	175	115	28,00	5	004150260
10,00	184	121	37,00	5	004150264

416

Zylinderbohrer mit Sonderschliff und Doppelseitenschneider

R ≤ 900 N/mm²
HV ~ 820÷850

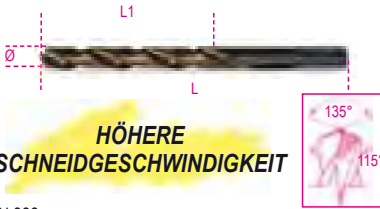

HÖHERE SCHNEIDGESCHWINDIGKEIT

DIN 338

Ø mm	L mm	L1 mm	€	🔧	📦
1,00	34	12	3,20	10	004160010
1,50	40	18	3,20	10	004160015
2,00	49	24	3,20	10	004160020
2,50	57	30	3,30	10	004160025
3,00	61	33	3,60	10	004160030
3,50	70	39	3,90	10	004160035
4,00	75	43	4,40	10	004160040
4,50	80	47	4,90	10	004160045
5,00	86	52	5,50	10	004160050
5,50	93	57	7,00	10	004160055
6,00	93	57	7,50	10	004160060
6,50	101	63	8,90	10	004160065
7,00	109	69	10,20	10	004160070
7,50	109	69	11,00	5	004160075
8,00	117	75	13,00	5	004160080
8,50	117	75	14,10	5	004160085
9,00	125	81	16,50	5	004160090
9,50	125	81	17,70	5	004160095
10,00	133	87	20,40	5	004160100



416/SP19 Ø 1÷10 x 0,5 mm	€ 154,00	🔧 1	📦 004160419
410/SPVP1	€ 29,50	🔧 1	📦 004100421

416P/SP19

Spiralbohrersatz, 19-teilig, aus HSS, AISI M2, mit reduzierter Spitze für Zentrierung

Ø 1÷10 x 0,5 mm
HÖHERE BOHRGESCHWINDIGKEIT
R ≤ 900 N/mm²
HV ~ 820÷850

HÖHERE SCHNEIDGESCHWINDIGKEIT

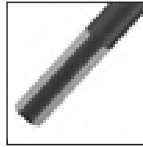

416P/SP19	€ 168,00	🔧 1	📦 004160469
-----------	----------	-----	-------------

📏 115x170x40 mm

417

Maurerspiralbohrer, zylindrisch, kurze Ausführung, aus gefrästem Stahl, mit Hartmetallplättchen

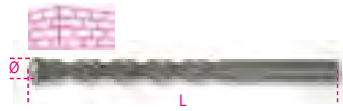

DIN 8039

Ø mm	L mm	€	🔧	📦
3	70	4,30	10	004170003
4	75	4,30	10	004170004
5	85	4,50	10	004170005
5L	150	9,80	5	004170105
6	100	4,60	10	004170007
6L	150	9,80	5	004170106
7	120	5,10	10	004170009
8	120	5,60	10	004170010
8L	200	10,60	5	004170113
9	120	6,40	10	004170011
10	120	7,40	10	004170012
10L	200	12,70	5	004170120
12	150	9,60	10	004170014
12L	200	13,80	5	004170125
14	150	13,30	5	004170016
16	150	16,50	5	004170018



417/SP8 Ø 3-4-5-6-8-9-10-12 mm	€ 62,50	🔧 1	📦 004170100
-----------------------------------	---------	-----	-------------

419

Maurerbohrer, mit gefrästem Körper und Hartmetallplättchen

HVA~ 1650

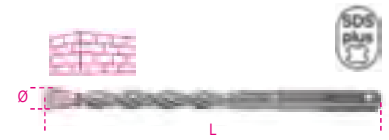

Ø mm	L mm	€	🔧	📦
4	110	8,50	10	004190002
5	110	8,50	10	004190004
5	160	9,40	10	004190006
6	110	8,30	10	004190012
6	160	9,20	10	004190014
6	210	12,10	10	004190016
7	160	10,00	10	004190028
8	110	9,00	10	004190030
8	160	9,60	10	004190032
8	210	11,60	10	004190034
8	260	15,70	10	004190036
8	310	19,20	10	004190038
8	460	35,00	10	004190042
9	160	11,80	5	004190044
10	160	12,10	5	004190050
10	210	14,00	5	004190052
10	260	17,50	5	004190054
10	310	24,50	5	004190056
10	460	38,50	5	004190060
12	160	13,40	5	004190064
12	210	18,30	5	004190066
12	260	19,60	5	004190068
12	460	40,00	5	004190074
14	160	18,60	3	004190086
14	260	22,40	3	004190090
14	310	32,00	3	004190092
14	460	41,50	3	004190096
16	210	27,00	3	004190112
16	260	29,00	3	004190114
16	310	35,00	3	004190116
16	460	46,50	3	004190120
18	260	37,50	1	004190124
20	310	37,50	1	004190128



419/SP7	€ 87,00	🔧 1	📦 004190507
Ø 5 - 6 - 8 x 110 mm			
Ø 6 - 8 - 10 - 12 x 160 mm			



419T

Mauerbohrer, gefräster Körper mit 4 Spiralen und 4 Schneidern
HVA- 1650

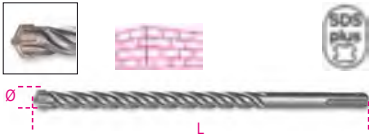

Ø mm	L mm	€		
5	110	5,80	5	004190604
5	160	6,50	5	004190606
6	110	6,10	5	004190612
6	160	7,10	5	004190614
6	210	9,60	5	004190616
7	160	7,30	5	004190628
8	110	6,70	5	004190630
8	160	7,50	5	004190632
8	210	9,90	5	004190634
8	260	11,30	5	004190636
8	310	13,80	5	004190638
9	160	7,90	3	004190644
10	160	8,10	3	004190650
10	210	10,60	3	004190652
10	260	11,50	3	004190654
10	310	16,40	3	004190656
10	460	22,20	3	004190660
12	160	8,90	3	004190664
12	210	11,60	3	004190666
12	260	12,30	3	004190668
12	460	22,80	3	004190674
14	160	12,00	2	004190686
14	260	14,00	2	004190690
14	310	19,80	2	004190692
14	460	22,20	2	004190696
16	210	15,90	2	004190712
16	260	21,00	2	004190714
16	310	22,70	2	004190716
16	460	23,50	2	004190720
18	260	25,50	1	004190724
20	310	31,50	1	004190728

421

Senkersaft mit Führungsstift, Feinwinkel, aus HSS-Stahl



DIN 373

M	L mm	Ø mm	D1 mm	D mm	€		
3	71	6	3,2	5	30,50	1	004210003
4	71	8	4,3	5	30,50	1	004210004
5	80	10	5,3	8	30,50	1	004210005
6	80	11	6,4	8	31,50	1	004210006
8	100	15	8,4	12,5	51,00	1	004210008
10	100	18	10,5	12,5	60,50	1	004210010
12	100	20	13,0	12,5	65,50	1	004210012



	€		
421/SP6 M 3-4-5-6-8-10	250,00	1	004210019
421/SPV	18,60	1	004210020

422

Zentrierbohrer geschliffen Senkwinkel 60° aus HSS-Stahl

• Zur schnellen und sicheren Ausführung von Zentrierlöchern

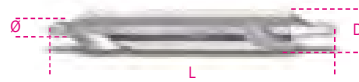

DIN 333/A

Ø mm	D mm	L mm	€		
1,60	4,0	35,5	9,80	1	004220116
2,50	6,3	45,0	11,20	1	004220125
3,15	8,0	50,0	12,60	1	004220131

423

Schaftfräser, aus HSS, geschliffen



Ø mm	L mm	€		
6	66	19,20	5	004230006
7	74	23,50	5	004230007
8	79	25,50	5	004230008
10	89	30,00	5	004230010

423A

Schaftfräser, mit Zentrierbohrer, aus HSS, geschliffen



DIN 1412/E

Ø mm	L mm	€		
6,5	40	28,50	1	004230015
8,0	40	30,50	1	004230020

424

Aufreibbohrer aus HSS



	L mm	Ø mm	D mm	€		
424/1	58	3÷14	6	35,50	2	004240001
424/2	63	6÷20	8	59,50	2	004240002
424/3	60	16÷30	10	103,00	2	004240003
424/4	80	3÷22	8	126,00	1	004240004
424/5	102	3÷31	10	169,00	1	004240005
424/6	86	26÷40	13	215,00	1	004240006
424/7	89	36÷50	13	322,00	1	004240007
424/8	90	40÷61	13	533,00	1	004240008



	€		
424/SP3 424/1+424/2+424/3 Ø 3÷30 mm	205,00	1	004240019
424/SPV	28,50	1	004240020

425

Mehrfasenstufenbohrer aus HSS



	L mm	Ø mm	S mm	D mm	€		
425/1	70	4÷12	1	6	60,00	2	004250010
425/2	55	4÷12	2	6	63,50	2	004250012
425/3	85	4÷20	2	10	92,50	2	004250015
425/4	85	12÷20	1	10	142,00	1	004250016
425/5	97	20÷30	1	10	278,00	1	004250017
425/6	75	4÷30	2	10	194,00	1	004250020
425/7	97	30÷40	1	13	385,00	1	004250025
425/8	100	40÷50	1	13	538,00	1	004250029



	€		
425/SP3 425/1+425/3+425/6 Ø 4÷30 mm	353,00	1	004250030
425/SPV	28,50	1	004250035

426

Senkfräser,
3fach,
aus HSS



DIN 335-C

GR	Ø mm	L mm	Ø1 mm	€	🔧	📦
1	4,3	44	4	20,10	3	004260001
2	5,3	44	4	20,10	3	004260002
3	6,3	44	5	21,10	3	004260003
4	7,3	44	6	24,70	3	004260004
5	8,3	50	6	24,70	3	004260005
6	9,4	50	6	27,50	3	004260006
7	10,4	54	6	30,50	3	004260007
8	12,4	54	8	33,00	3	004260008
9	15,0	56	10	37,50	3	004260009
10	16,5	60	10	39,50	3	004260010
11	20,5	63	10	54,00	3	004260011
12	25,0	66	10	86,00	3	004260012
13	28,0	71	12	116,00	3	004260013
14	31,0	71	12	123,00	3	004260014



DIN 335-C

426/SP6	€	🔧	📦
GR 3-5-7-8-10-11 Ø 6,3÷20,5 mm	215,00	1	004260030
426/SPV	28,50	1	004260035

426A/SP6

Senkfräsersatz, 6-teilig, mit drei
asymmetrischen, spiralförmigen Fräsern aus
HSS-Stahl

Ø 6,3 - 8,3 - 10,4 - 12,4 - 16,5 - 20,5 mm



426A/SP6	€	🔧	📦
Ø 6,3-8,3-10,4-12,4-16,5-20,5 mm	225,00	1	004260060

100x145x40 mm

426T

Senkfräser,
3fach,
aus HSS + TiN



DIN 335-C

GR	Ø mm	L mm	Ø1 mm	€	🔧	📦
1	4,3	44	4	26,00	3	004260061
2	5,3	44	4	26,00	3	004260062
3	6,3	44	5	26,50	3	004260063
4	7,3	44	6	30,00	3	004260064
5	8,3	50	6	30,00	3	004260065
6	9,4	50	6	32,00	3	004260066
7	10,4	54	6	37,50	3	004260067
8	12,4	54	8	39,00	3	004260068
9	15,0	56	10	44,00	3	004260069
10	16,5	60	10	49,00	3	004260070
11	20,5	63	10	63,50	3	004260071
12	25,0	66	10	96,50	3	004260072
13	28,0	71	12	121,00	3	004260073
14	31,0	71	12	130,00	3	004260074



DIN 335-C

426T/SP6	€	🔧	📦
GR 3-5-7-8-10-11 Ø 6,3÷20,5 mm	246,00	1	004260080
426/SPV	28,50	1	004260035

426SB

Senkfräser, geschliffen aus HSS

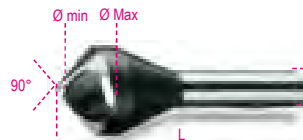

GR	Ø mm	D mm	L mm	€	🔧	📦
426/SB1	1	2÷5	6 45	27,00	1	004260101
426/SB2	2	5÷10	8 48	33,50	1	004260102
426/SB3	3	10÷15	10 65	60,00	1	004260103
426/SB4	4	15÷20	12 85	116,50	1	004260104
426/SB5	5	20÷25	15 102	196,00	1	004260105
426/SB6	6	25÷30	15 115	331,00	1	004260106



426SB/SP4	€	🔧	📦
426/SB1-426/SB2 426/SB3-426/SB4 Ø 2÷20 mm	270,00	1	004260130
426SB/SPV1	28,50	1	004260135

426MD-3/CP3

Mini-Drehfräser aus Hartmetall

• Kreuzschnitt mit Spanbrecher



L mm	Ø mm	€	🔧	📦
38,1	3	14,90	1	004260332

426MD-3/CT3

Mini-Drehfräser aus Hartmetall

• Kreuzschnitt mit Spanbrecher



L mm	Ø mm	€	🔧	📦
37,8	3	14,90	1	004260333

426MD-3/F3

Mini-Drehfräser aus Hartmetall

• Kreuzschnitt mit Spanbrecher



L mm	Ø mm	€	🔧	📦
38,3	3	14,90	1	004260334

426MD-3/FA3

Mini-Drehfräser aus Hartmetall

• Kreuzschnitt mit Spanbrecher



L mm	Ø mm	€	🔧	📦
38,2	3	14,90	1	004260339

426MD-3/OG3

Mini-Drehfräser aus Hartmetall

• Kreuzschnitt mit Spanbrecher



L mm	Ø mm	€	🔧	📦
38,1	3	14,90	1	004260337

426MD-3/OV3

Mini-Drehfräser aus Hartmetall

• Kreuzschnitt mit Spanbrecher



L mm	Ø mm	€	1	004260331
38,2	3	14,90		

426MD-3/S3

Mini-Drehfräser aus Hartmetall

• Kreuzschnitt mit Spanbrecher



L mm	Ø mm	€	1	004260338
38,0	3	14,90		

426MD-3/T3

Mini-Drehfräser aus Hartmetall

• Kreuzschnitt mit Spanbrecher



L mm	Ø mm	€	1	004260336
38,3	3	14,90		

426MD-3/TA3

Mini-Drehfräser aus Hartmetall

• Kreuzschnitt mit Spanbrecher



L mm	Ø mm	€	1	004260335
38,3	3	14,90		



426MD-3/A9

€ 134,00 1 004260349

426MD-3/OV3 - 426MD-3/CP3
426MD-3/CT3 - 426MD-3/F3
426MD-3/TA3 - 426MD-3/T3
426MD-3/OG3 - 426MD-3/S3
426MD-3/FA3

426MD/CP

Rotierfeilen aus Hartmetall

Kreuzhieb HM4



L mm	Ø mm	€	1	004260532
50	6	41,50		
63	8	45,50		
63	9,5	51,50		
69	12	72,50		
69	16	104,00		

426MD/CT

Rotierfeilen aus Hartmetall

Kreuzhieb HM4



L mm	Ø mm	€	1	004260533
50	6	41,50		
63	8	45,50		
63	9,5	51,50		
69	12	72,50		
69	16	101,00		

426MD/F

Rotierfeilen aus Hartmetall

Kreuzhieb HM4



L mm	Ø mm	€	1	004260534
50	6	41,50		
63	8	45,50		
63	9,5	51,50		
69	12	72,50		
69	16	82,00		

426MD/FA

Rotierfeilen aus Hartmetall

Kreuzhieb HM4



L mm	Ø mm	€	1	004260539
50	6	41,50		
63	8	45,50		
63	9,5	51,50		
69	12	72,50		
69	16	93,00		

426MD/OG

Rotierfeilen aus Hartmetall

Kreuzhieb HM4



L mm	Ø mm	€	1	004260537
50	6	41,50		
63	8	45,50		
70	10	51,50		
76	12	72,50		
81	16	104,00		

426MD/OV

Rotierfeilen aus Hartmetall

Kreuzhieb HM4



L mm	Ø mm	€	1	004260531
50	6	41,50		
61	9,5	51,50		
67	12	72,50		
69	16	93,00		

426MD/S

Rotierfeilen aus Hartmetall

Kreuzhieb HM4

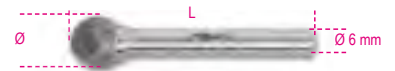

L mm	Ø mm	€	1	004260538
50	6	41,50		
51	8	45,50		
53	9,5	51,50		
56	12	72,50		
59	16	82,00		

426MD/T

Rotierfeilen aus Hartmetall

Kreuzhieb HM4



L mm	Ø mm	€	1	004260536
50	6	41,50		
63	8	45,50		
63	9,5	51,50		
69	12	72,50		
70	16	82,00		

426MD/TA

Rotierfeilen aus Hartmetall

Kreuzhieb HM4



L mm	Ø mm	€	1	004260535
50	6	41,50		
67	8	45,50		
72	9,5	51,50		
73	12	72,50		
78	16	104,00		



426MD/SP10

426MD/CP-426MD/CT-426MD/F
426MD/T-426MD/S
Ø 8-12 mm

€ 536,00 1 004260510

427

Keilastreiber für Morsekegel



DIN 317

GR	L mm	A mm	€	🔧	📦
0	92	13	14,40	3	004270000
1-2	140	19	20,30	3	004270002
3	190	25	24,60	3	004270003
4	225	30	41,50	3	004270004
5-6	260	35	75,50	3	004270006

428FP

Maschinengewindebohrer für durchgehende Bohrungen, hohe Steigung, aus HSS

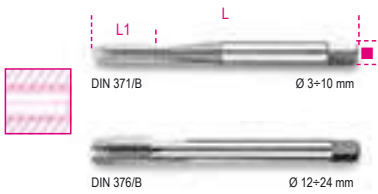

ISO 529

M	■ mm	L mm	L1 mm	€	🔧	📦
3x0,5	2,7	56	11	19,70	10	004280003
4x0,7	3,4	63	13	19,70	10	004280004
5x0,8	4,9	70	16	19,70	10	004280005
6x1	4,9	80	19	20,70	10	004280006
8x1,25	6,2	90	22	25,00	10	004280008
10x1,5	8,0	100	24	29,50	10	004280010
12x1,75	7,0	110	29	38,50	5	004280012
14x2	9,0	110	30	47,00	5	004280014
16x2	9,0	110	30	56,50	5	004280016
18x2,5	11,0	125	34	72,50	3	004280018
20x2,5	12,0	140	34	81,50	3	004280020
22x2,5	14,5	140	34	98,00	3	004280022
24x3	14,5	160	38	107,00	3	004280024

428FC

Maschinengewindebohrer für Blindbohrungen, hohe Steigung, aus HSS



M	■ mm	L mm	L1 mm	€	🔧	📦
3x0,5	2,7	56	11	23,80	10	004280103
4x0,7	3,4	63	13	23,80	10	004280104
5x0,8	4,9	70	16	23,80	10	004280105
6x1	4,9	80	19	24,50	10	004280106
8x1,25	6,2	90	22	26,50	10	004280108
10x1,5	8,0	100	24	31,50	10	004280110
12x1,75	7,0	110	29	40,00	5	004280112
14x2	9,0	110	30	53,50	5	004280114
16x2	9,0	110	30	63,00	5	004280116
18x2,5	11,0	125	34	85,00	3	004280118
20x2,5	12,0	140	34	91,00	3	004280120
22x2,5	14,5	140	34	111,00	3	004280122
24x3	14,5	160	38	118,00	3	004280124

428/C14

Maschinengewindebohrersatz Art. 428FP+428FC, 14teilig



428/C14	€	🔧	📦
428FP M3÷12	428,00	1	004280201
428FC M3÷12			
428/SPV	25,00	1	004280202

429FP

Maschinengewindebohrer für durchgehende Bohrungen, hohe Steigung, aus HSS-CO 5%

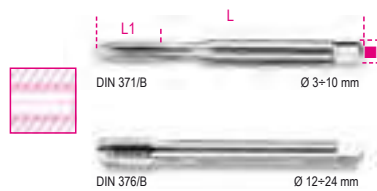

ISO 529

M	■ mm	L mm	L1 mm	€	🔧	📦
3x0,5	2,7	56	11	25,50	5	004290003
4x0,7	3,4	63	13	25,50	5	004290004
5x0,8	4,9	70	16	25,50	5	004290005
6x1	4,9	80	19	27,50	5	004290006
8x1,25	6,2	90	22	30,50	5	004290008
10x1,5	8,0	100	24	36,50	5	004290010
12x1,75	7,0	110	29	45,00	5	004290012
14x2	9,0	110	30	60,50	5	004290014

429FC

Maschinengewindebohrer für Blindbohrungen, hohe Steigung, aus HSS-CO 5%



M	■ mm	L mm	L1 mm	€	🔧	📦
3x0,5	2,7	56	11	31,50	5	004290103
4x0,7	3,4	63	13	31,50	5	004290104
5x0,8	4,9	70	16	31,50	5	004290105
6x1	4,9	80	19	33,00	5	004290106
8x1,25	6,2	90	22	37,00	5	004290108
10x1,5	8,0	100	24	44,50	5	004290110
12x1,75	7,0	110	29	53,50	5	004290112
14x2	9,0	110	30	70,50	5	004290114

429/C14

Maschinengewindebohrersatz Art. 429FP+429FC, 14teilig



429/C14	€	🔧	📦
429FP M3÷12	525,00	1	004290201
429FC M3÷12			
428/SPV	25,00	1	004280202

430

Handgewindebohrer, hohe Steigung, metrisches Gewinde, aus Chromstahl



DIN 352 UNI 4535

M	■ mm	L mm	L1 mm	€	🔧	📦
2x0,4	2,5	36	11	17,10	5	004300002
3x0,5	2,5	40	12	12,10	5	004300003
4x0,7	3,0	45	14	12,10	5	004300004
5x0,8	4,0	48	16	12,60	5	004300005
6x1	5,0	50	18	12,70	5	004300006
7x1	4,5	50	18	16,20	5	004300007
8x1,25	5,0	56	22	16,40	3	004300008
9x1,25	5,5	63	22	22,20	3	004300009
10x1,5	6,0	70	25	21,00	3	004300010
11x1,5	7,0	70	25	27,00	3	004300011
12x1,75	7,0	75	30	27,00	3	004300012
14x2	8,0	80	32	34,00	3	004300014
16x2	10,0	80	32	40,00	3	004300016
18x2,5	11,0	95	40	53,50	1	004300018
20x2,5	12,0	95	40	64,00	1	004300020
22x2,5	14,5	100	40	78,00	1	004300022
24x3	14,5	110	50	92,50	1	004300024



430/SP21	€	🔧	📦
M 3-4-5-6-8-10-12	145,00	1	004300201
430/SPV	30,00	1	004300202

430ASW

Handgewindebohrer, Whitworthgewinde, aus Chromstahl



DIN 352

BSW	mm	L mm	L1 mm	€	Hand	Power
1/8x40	2,7	40	12	11,90	5	004300031
5/32x32	3,4	45	14	11,90	5	004300032
3/16x24	4,3	48	18	11,90	5	004300033
1/4x20	4,9	50	22	13,90	5	004300034
5/16x18	4,9	56	25	16,80	3	004300035
3/8x16	5,5	70	28	22,20	3	004300036
7/16x14	6,2	70	30	25,00	3	004300037
1/2x12	7,0	75	32	28,00	3	004300038
9/16x12	9,0	80	32	34,00	1	004300039
5/8x11	9,0	80	38	41,00	1	004300040
3/4x10	11,0	95	40	59,00	1	004300041
7/8x9	14,5	100	40	74,50	1	004300042
1"x8	16,0	110	50	96,00	1	004300043

430ASC

Handgewindebohrer, UNC-Gewinde, aus Chromstahl



ANSI B1.1

UNC	mm	L mm	L1 mm	€	Hand	Power
1/4x20	4,9	70	30	17,70	5	004300051
5/16x18	4,9	70	30	22,80	5	004300052
3/8x16	5,5	75	35	25,50	3	004300053
7/16x14	6,2	80	40	33,50	3	004300054
1/2x13	7,0	85	45	42,00	3	004300055
9/16x12	9,0	90	45	51,50	3	004300056
5/8x11	9,0	100	47	59,00	3	004300057
3/4x10	11,0	110	50	80,00	3	004300058
7/8x9	14,5	120	60	92,00	1	004300059
1"x8	16,0	130	60	104,00	1	004300060

431

Handgewindebohrer, hohe Steigung, metrisches Gewinde, aus HSS



DIN 352 UNI 4535

M	mm	L mm	L1 mm	€	Hand	Power
3x0,5	2,5	40	12	22,80	5	004310003
4x0,7	3,0	45	14	22,80	5	004310004
5x0,8	4,0	48	16	23,50	5	004310005
6x1	5,0	50	18	23,50	5	004310006
7x1	5,0	50	18	31,50	5	004310007

M	mm	L mm	L1 mm	€	Hand	Power
8x1,25	5,0	56	22	28,00	3	004310008
10x1,5	6,0	70	25	35,00	3	004310010
12x1,75	7,0	75	30	53,00	3	004310012
14x2	9,0	80	32	74,50	1	004310014
16x2	9,0	80	32	84,00	1	004310016
18x2,5	11,0	95	40	126,00	1	004310018
20x2,5	12,0	95	40	135,00	1	004310020
22x2,5	12,0	100	40	193,00	1	004310022
24x3	14,5	110	50	218,00	1	004310024



431/SP21	€	Hand	Power
431/SP21	264,00	1	004310201
M 3-4-5-6-8-10-12			
431/SPV	30,00	1	004310202

433

Handgewindebohrer, Feingewinde, metrisch, aus Chromstahl



DIN 2181 UNI 4535

M	mm	L mm	L1 mm	€	Hand	Power
6x0,75	4,5	48	16	10,60	5	004330201
7x0,75	4,5	56	18	13,10	5	004330202
8x0,75	5,0	50	16	13,10	5	004330203
8x1	5,0	56	16	13,10	5	004330204
9x0,75	6,0	63	22	17,10	5	004330205
9x1	6,0	63	22	17,10	5	004330206
10x0,75	6,5	63	18	17,10	5	004330207
10x1	6,5	63	18	17,10	5	004330208
10x1,25	6,5	63	18	17,10	5	004330209
11x0,75	7,0	70	25	23,10	3	004330210
11x1	7,0	70	25	23,10	3	004330211
11x1,25	7,0	70	25	23,10	3	004330212
12x0,75	7,0	70	20	22,40	3	004330213
12x1	7,0	70	20	22,40	3	004330214
12x1,25	7,0	70	20	22,40	3	004330215
12x1,5	7,0	70	20	22,40	3	004330216
14x1	8,0	80	32	29,50	1	004330217
14x1,25	8,0	80	32	29,50	1	004330218
14x1,5	8,0	80	32	29,50	1	004330219
16x1	10,0	80	32	34,50	1	004330220
16x1,5	10,0	80	32	34,50	1	004330221
18x1,5	11,0	95	40	41,00	1	004330222
18x2	11,0	80	25	53,00	1	004330223
20x1,5	14,5	80	22	60,50	1	004330224
22x1,5	14,5	80	22	72,00	1	004330225
24x1,5	14,5	80	22	84,00	1	004330226
24x2	14,5	80	22	83,00	1	004330227

433ASF

Handgewindebohrer, Feingewinde, UNF, aus Chromstahl



ANSI B1.1

UNF	mm	L mm	L1 mm	€	Hand	Power
1/4x28	4,9	70	30	13,30	5	004330301
5/16x24	4,9	70	30	15,90	5	004330302
3/8x24	5,5	75	35	18,00	3	004330303
7/16x20	6,2	80	40	22,80	3	004330304
1/2x20	7,0	85	45	28,50	3	004330305
9/16x18	9,0	90	45	36,50	3	004330306
5/8x18	9,0	100	47	41,00	3	004330307
3/4x16	11,0	110	50	55,50	3	004330308
7/8x14	14,5	120	60	71,50	1	004330309
1"x12	16,0	130	60	97,50	1	004330310

433ASG

Handgewindebohrer, Zylindergasgewinde, aus Chromstahl



DIN 5157

GAS	mm	L mm	L1 mm	€	Hand	Power
1/8x28	5,5	65	18	19,00	1	004330401
1/4x19	9,0	70	24	24,30	1	004330402
3/8x19	9,0	75	25	29,50	1	004330403
1/2x14	12,0	80	31	41,50	1	004330405
3/4x14	16,0	90	33	68,00	1	004330408
1"x11	20,0	100	39	111,00	1	004330410

434

Handgewindebohrer, Feingewinde, metrisch, aus HSS

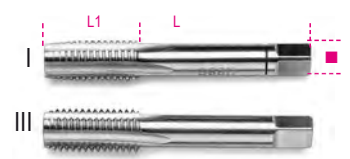

DIN 2181 UNI 4535

M	mm	L mm	L1 mm	€	Hand	Power
6x0,75	4,5	48	16	30,00	5	004340001
8x0,75	5,0	56	16	35,00	5	004340003
8x1	5,0	56	16	35,00	5	004340004
10x0,75	6,5	63	18	44,50	5	004340007
10x1	6,5	63	18	44,50	5	004340008
10x1,25	6,5	63	18	44,50	5	004340009
12x1	7,0	70	20	47,50	3	004340014
12x1,25	7,0	70	20	47,50	3	004340015
12x1,5	7,0	70	20	47,50	3	004340016
13x1,5	9,0	70	20	99,50	1	004340017
14x1	9,0	70	20	59,00	1	004340018
14x1,25	9,0	70	20	59,00	1	004340019
14x1,5	9,0	70	20	51,00	1	004340020
15x1,5	9,0	70	20	99,50	1	004340021
16x1	9,0	70	20	63,50	1	004340022
16x1,5	9,0	70	20	55,00	1	004340023
18x1,5	11,0	80	22	71,00	1	004340024
18x2	11,0	90	25	86,00	1	004340025
20x1,25	12,0	80	22	122,00	1	004340026
20x1,5	12,0	80	22	75,50	1	004340027
20x2	12,0	90	25	93,00	1	004340028
22x1,5	14,5	80	22	109,00	1	004340029
24x1	14,5	80	22	145,00	1	004340030
24x1,5	14,5	80	22	122,00	1	004340031
24x2	14,5	80	22	128,00	1	004340032



435

Verstellbare Windeisen,
Gehäuse aus Stahl

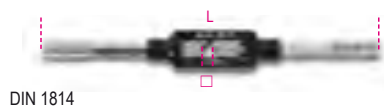

DIN 1814

	□ mm	L mm	€		
435/0	2÷5 M1÷M8	170	20,50	3	004350007
435/1	2÷6 M1÷M10	200	24,60	2	004350009
435/1,5	2,5÷6 M1÷M12	200	26,00	2	004350011
435/2	3÷7 M4÷M12	260	37,00	2	004350013
435/3	4÷12 M5÷M20	345	61,50	1	004350020
435/4	5,5÷16 M9÷M27	430	95,50	1	004350027
435/5	7÷18 M13÷M32	770	217,00	1	004350032

435G

Verstellbare Windeisen,
Gehäuse aus Leichtmetall



DIN 1814

	□ mm	L mm	€		
435G/0	2÷5 M1÷M8	130	14,60	5	004350108
435G/1	2÷6 M1÷M10	190	17,80	5	004350110
435G/1,5	2÷7 M2÷M12	175	18,60	5	004350112
435G/2	3,4÷7 M4÷M12	280	30,50	5	004350114
435G/3	4,9÷12 M5÷M20	380	49,00	2	004350121
435G/4	7÷16 M11÷M27	500	78,00	2	004350127
435G/5	7÷18 M13÷M32	700	124,00	1	004350132
435G/6	11÷24 M18÷M42	800	204,00	1	004350142

436

Werkzeughalter mit Umschaltknarre

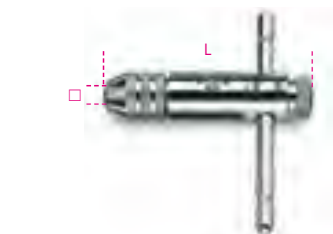

	□ mm	L mm	€		
436/1	2÷5 M3÷M8	85	34,00	5	004360002
436/2	4,6÷8 M5÷M12	110	43,50	5	004360004

436L

Werkzeughalter mit Umschaltknarre,
lange Ausführung



	□ mm	L mm	€		
436L/1	2÷5 M3÷M8	245	53,50	2	004360012
436L/2	4,6÷8 M5÷M12	295	62,50	2	004360014

436R

Ersatzspanbacken für Art. 436 und 436L

	€		
436R/1	6,50	1	004360022
436R/2	7,30	1	004360024

437P

Gewindefräser,
zur Wiederherstellung von Innen- und
Außengewinden, rechts- und linksläufig

P 0,80÷3,00 mm



L mm	€		
230	55,50	1	004370003

437C

Satz zur Behebung von
Zündkerzengewindebeschädigungen,
M14x1,25 mm
• Schraubenflächenhöhe: 8,40 - 12,40 - 16,40 mm (5 St. pro
Größe)



437C	€		
	145,00	1	004370100

437C/...

Schraubenflächen aus Edelstahl für Art. 437C



H mm	€		
8.4	37,00	1	004370108
12.4	37,00	1	004370112
16.4	37,00	1	004370116

Die angegebenen Preise beziehen sich auf 10 Stück.

437C/RM14

Gewindebohrer für Zündkerzen



437C/RM14	€		
	120,00	1	004370124

437K/8

Werkzeugsortiment zur Wiederherstellung
von Antriebswelle-Gewinden

- Ermöglicht das Nachschneiden und Wiederherstellen des Originalgewindes:
- Kitinhalt
- Metrische Maße:
20x1,25 - 20x1,5 - 22x1,00 - 22x1,5 - 24x1,5 - 24x2,00
- Zollmaße
3/4x20 - 13/16x20



○ 32 mm

437K/8	€		
	95,00	1	004370020

≡ 200x110x30 mm

437K/9

Werkzeugsortiment zur Wiederherstellung von
Außen- und Innengewinden,
Radbefestigungsschrauben

Ermöglicht das Nachschneiden und Wiederherstellen des
Originalgewindes

- Kitinhalt:
- Gewindebohrer:
M12x1,25 - M12x1,5 - M12x1,75 - M14x1,5
- Gewindefräser:
M12x1,25 - M12x1,5 - M14x1,5



○ 12 - 24 mm

437K/9	€		
	101,00	1	004370029

≡ 161x123x50 mm

437K/12

Werkzeugsortiment zur Wiederherstellung von Antriebswelle-Gewinden

Ermöglicht das Nachschneiden und Wiederherstellen des Originalgewindes

Kitinhalt:

• Metrische Maße:

M16x1,0 - M16x1,5 - M20x1,0 - M20x1,5 - M22x1,5 - M24x1,5 - M24x2,0 - M27x2,0

• Zollmaße:

3/4x16 - 3/4x20 - 13/16x20 - 27/32x20



∅ 32 - 35 mm

437K/12 € 120,00 1 004370032

220x118x52 mm

437K/16

Werkzeugsortiment zur Reparatur von beschädigten Gewinden auf Bremsattelhalterungen M9x1,25



437K/16 € 135,00 1 004370016

210x150x50 mm

437K/33

Werkzeugsortiment zur Reparatur von beschädigten Zündkerzengewinden

Gewindeeinsatz:

M8x1,0 - M10x1,0 - M10x1,25 - M12x1,25

Gewindebohrer:

M8x1,0 - M10x1,0 - M10x1,25 - M12x1,0 - M12x1,25 - M14x1,25



437K/33 € 333,00 1 004370133

210x150x50 mm

437U/09

Werkzeugsortiment zur Behebung von Gewindebeschädigungen M5-M6-M8-M10-M12



25 x M5, M6, M8, M10
10 x M12

437U/09 € 403,00 1 004370550

M5X0,8

M6X1,0

M8X1,25

M10X1,5

M12X1,75

370x230x55 mm - 2 Kg

437U/E-M...

Schraubenflächen aus Edelstahl



	H mm	€		
M5	7.5	21,50	1	004370555
M6	9	21,50	1	004370556
M8	12	29,50	1	004370558
M10	15	39,00	1	004370560
M12	18	24,50	1	004370562

Die angegebenen Preise beziehen sich auf 25 Teile (10 für M12)

437U/PM

Bohrer und Gewindeschneideisen für Art. 437U/09



	€		
M5	40,00	1	004370565
M6	42,00	1	004370566
M8	56,50	1	004370568
M10	74,50	1	004370570
M12	92,50	1	004370572

438A

Bohrersatz zum Bohren, Schneiden und Spitzensenken, aus HSS

- M3 - M4 - M5 - M6 - M8 - M10
- Mit magnetischem Schraubeinsatzhalter



±0,05 S MAX mm = Ø mm

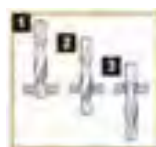

438A € 136,00 1 004380010

438...

Bohrersatz zum Bohren, Schneiden und Spitzensenken
Aus HSS, Anschluss 1/4"

1/4"



	S max mm	€		
M3	3	26,00	2	004380103
M4	4	26,00	2	004380104
M5	5	26,00	2	004380105
M6	6	26,00	2	004380106
M8	8	29,50	2	004380108
M10	10	29,50	2	004380110

440

Gewindeschneideisen, rund, hohe Steigung, metrisches Gewinde, aus Chromstahl

R ≤ 600 N/mm²
HRC 60-61



UNI 4535
DIN 223

M	Ø x S mm	€		
2x0,4	25,4 x 9	20,60	5	004400002
3x0,5	25,4 x 9	15,10	5	004400003
4x0,7	25,4 x 9	15,10	5	004400004
5x0,8	25,4 x 9	13,00	5	004400005
6x1	25,4 x 9	13,00	5	004400006
7x1	25,4 x 9	13,00	5	004400007
8x1,25	25,4 x 9	13,00	5	004400008
9x1,25	25,4 x 9	13,00	5	004400009
10x1,5	25,4 x 9	13,00	5	004400010
12x1,75	25,4 x 9	13,00	5	004400012

440A

Gewindeschneideisen, rund, hohe Steigung, metrisches Gewinde, aus Chromstahl

R ≤ 600 N/mm²
HRC 60-61



UNI 4535
DIN 223

M	Ø x S mm	€		
10x1,5	38,1 x 14	18,60	3	004400110
11x1,5	38,1 x 14	18,60	3	004400111
12x1,75	38,1 x 14	18,60	3	004400112
14x2	38,1 x 14	18,60	3	004400114
16x2	38,1 x 14	18,60	3	004400116
18x2,5	38,1 x 14	21,60	3	004400118
20x2,5	38,1 x 14	23,80	3	004400120

440B

Gewindeschneideisen, rund,
hohe Steigung, metrisches Gewinde,
aus Chromstahl

R ≤ 600 N/mm²
HRC || 60+61



UNI 4535
DIN 223

M	Ø x S mm	€	⚙️	📄
18x2,5	50,8 x 16	33,00	3	004400122
20x2,5	50,8 x 16	34,50	3	004400124
22x2,5	50,8 x 16	37,50	3	004400126
24x3	50,8 x 16	38,00	3	004400128

440ASW

Gewindeschneideisen, rund,
Whitworthgewinde, aus Chromstahl

R ≤ 600 N/mm²



UNI EN 22568
DIN 223

BSW	Ø x S mm	€	⚙️	📄
1/8x40	25,4 x 9	17,60	5	004400201
5/32x32	25,4 x 9	17,60	5	004400202
3/16x24	25,4 x 9	15,70	5	004400203
1/4x20	25,4 x 9	15,70	5	004400204
5/16x18	25,4 x 9	15,70	5	004400205
3/8x16	38,1 x 14	22,40	3	004400206
7/16x14	38,1 x 14	22,40	3	004400207
1/2x12	38,1 x 14	23,10	3	004400208
9/16x12	38,1 x 14	23,10	3	004400209
5/8x11	50,8 x 16	40,00	3	004400210
3/4x10	50,8 x 16	40,00	3	004400211
7/8x9	50,8 x 16	46,50	3	004400212
1"x8	50,8 x 16	46,50	3	004400213

440ASC

Gewindeschneideisen, rund,
hohe Steigung, UNC-Gewinde,
aus Chromstahl

R ≤ 600 N/mm²

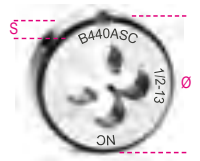

UNI EN 22568
DIN 223

UNC	Ø x S mm	€	⚙️	📄
1/4x20	25,4 x 9	15,60	5	004400221
5/16x18	25,4 x 9	15,60	5	004400222
3/8x16	38,1 x 14	21,60	3	004400223
7/16x14	38,1 x 14	21,60	3	004400224
1/2x13	38,1 x 14	21,60	3	004400225
9/16x12	38,1 x 14	21,60	3	004400226
5/8x11	50,8 x 16	45,00	3	004400227
3/4x10	50,8 x 16	45,00	3	004400228
7/8x9	50,8 x 16	45,00	3	004400229
1"x8	50,8 x 16	45,00	3	004400230

440ASF

Gewindeschneideisen, rund,
Feingewinde, UNF, aus Chromstahl

UNI EN 2258
DIN 223



UNF	Ø x S mm	€	⚙️	📄
1/4x28	25,4 x 9	16,50	5	004400241
5/16x24	25,4 x 9	16,50	5	004400242
3/8x24	38,1 x 14	23,50	3	004400243
7/16x20	38,1 x 14	23,50	3	004400244
1/2x20	38,1 x 14	23,50	3	004400245
9/16x18	38,1 x 14	23,50	3	004400246
5/8x18	50,8 x 16	47,50	3	004400247
3/4x16	50,8 x 16	47,50	3	004400248
7/8x14	50,8 x 16	47,50	3	004400249
1"x12	50,8 x 16	47,50	3	004400250

440ASG

Gewindeschneideisen, rund,
Zylindergasgewinde, aus Chromstahl

R ≤ 600 N/mm²



UNI EN 24231
DIN 223

GAS	Ø x S mm	€	⚙️	📄
1/8x28	38,1 x 14	18,60	3	004400255
1/4x19	38,1 x 14	18,60	3	004400256
3/8x19	38,1 x 14	18,60	3	004400257
1/2x14	50,8 x 16	38,00	3	004400259
3/4x14	50,8 x 16	38,00	3	004400260
1"x11	63,5 x 19	74,50	3	004400261

441

Gewindeschneideisen, rund,
Feingewinde, metrisch, aus Chromstahl

R ≤ 600 N/mm²
HRC || 60+61



UNI 4535
DIN 223

M	Ø x S mm	€	⚙️	📄
6x0,75	25,4 x 9	15,70	5	004410004
7x0,75	25,4 x 9	15,70	5	004410005
8x0,75	25,4 x 9	15,70	5	004410006
8x1	25,4 x 9	15,70	5	004410007
9x0,75	25,4 x 9	15,70	5	004410008
9x1	25,4 x 9	15,70	5	004410009

441A

Gewindeschneideisen, rund,
Feingewinde, metrisch, aus Chromstahl

R ≤ 600 N/mm²
HRC || 60+61

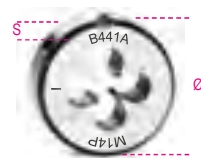

UNI 4535
DIN 223

M	Ø x S mm	€	⚙️	📄
10x0,75	38,1 x 14	23,50	3	004410100
10x1	38,1 x 14	23,50	3	004410101
10x1,25	38,1 x 14	23,50	3	004410102
11x0,75	38,1 x 14	23,50	3	004410103
11x1	38,1 x 14	23,50	3	004410104
11x1,25	38,1 x 14	23,50	3	004410105
12x0,75	38,1 x 14	23,50	3	004410106
12x1	38,1 x 14	23,50	3	004410107
12x1,25	38,1 x 14	23,50	3	004410108
12x1,5	38,1 x 14	23,50	3	004410109
14x1	38,1 x 14	23,50	3	004410110
14x1,25	38,1 x 14	23,50	3	004410111
14x1,5	38,1 x 14	23,50	3	004410112
16x1	38,1 x 14	23,50	3	004410113
16x1,5	38,1 x 14	23,50	3	004410114
18x1,5	38,1 x 14	23,50	3	004410115

441B

Gewindeschneideisen, rund,
Feingewinde, metrisch, aus Chromstahl

R ≤ 600 N/mm²
HRC || 60+61

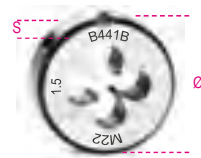

UNI 4535
DIN 223

M	Ø x S mm	€	⚙️	📄
18x1,5	50,8 x 16	44,00	3	004410117
18x2	50,8 x 16	44,00	3	004410118
20x1,5	50,8 x 16	44,50	3	004410119
22x1,5	50,8 x 16	46,50	3	004410120
24x1,5	50,8 x 16	47,00	3	004410121
24x2	50,8 x 16	47,00	3	004410122



442

Gewindeschneideisen, rund,
hohe Steigung, metrisches Gewinde,
aus HSS

HRC II 62+63
AISI M2



UNI EN 22568
DIN 223

M	ØxS mm	€		
3x0,5	20x5	18,30	3	004420003
4x0,7	20x5	18,30	3	004420004
5x0,8	20x7	18,60	3	004420005
6x1	20x7	18,60	3	004420006
7x1	25x9	20,70	3	004420007
8x1,25	25x9	20,70	3	004420008
10x1,5	30x11	23,50	3	004420010
12x1,75	38x14	39,50	3	004420012
14x2	38x14	51,00	1	004420014
16x2	45x18	64,00	1	004420016
18x2,5	45x18	68,00	1	004420018
20x2,5	45x18	68,00	1	004420020

443

Gewindeschneideisen, rund,
Feingewinde, metrisch, aus HSS

HRC II 62+63
AISI M2



UNI EN 22568
DIN 223

M	ØxS mm	€		
6x0,75	20x7	31,50	1	004430107
8x0,75	25x9	34,50	1	004430110
8x1	25x9	33,00	1	004430111
10x0,75	30x11	43,00	1	004430113
10x1	30x11	38,00	1	004430114
10x1,25	30x11	38,00	1	004430115
12x1	38x10	62,00	1	004430116
12x1,25	38x10	62,00	1	004430117
12x1,5	38x10	62,00	1	004430118
13x1,5	38x10	73,50	1	004430119
14x1	38x10	62,00	1	004430120
14x1,25	38x10	62,00	1	004430121
14x1,5	38x10	62,00	1	004430122
15x1,5	38x10	82,50	1	004430123
16x1	45x14	91,50	1	004430124
16x1,5	45x14	91,50	1	004430125
18x1,5	45x14	91,50	1	004430127
20x1,25	45x14	94,50	1	004430129
20x1,5	45x14	94,50	1	004430130
20x2	45x14	94,50	1	004430131
22x1,5	55x16	114,50	1	004430132
24x1	55x16	118,00	1	004430133
24x1,5	55x16	118,00	1	004430135
24x2	55x16	125,00	1	004430136

444

Schneideisenhalter, Gehäuse aus Stahl



EN 22568
DIN 225

	Ø mm	L mm	€		
444	20x5	190	24,70	5	004440005
444/0	20x7	190	24,70	5	004440007
444/1	25,4x9,5	210	25,50	5	004440025
444/1A	25x9	215	26,50	5	004440027
444/1B	30x11	250	30,50	5	004440030
444/C	38x10	310	39,00	3	004440033
444/1C	38x14	310	39,00	3	004440035
444/2	38,1x12,7	300	40,00	3	004440038
444/1D	45x14	445	55,00	1	004440045
444/2D	45x18	445	55,00	1	004440046
444/3	50,8x15,9	520	78,50	1	004440050
444/4	55x16	495	78,50	1	004440055
444/5A	63,5x19	520	136,00	1	004440057

444G

Schneideisenhalter, Gehäuse
aus Leichtmetall



UNI EN 22568
DIN 225

	Ø mm	L mm	€		
444G/A	16x5	160	11,70	5	004440103
444G	20x5	185	13,40	5	004440105
444G/0	20x7	185	13,40	5	004440107
444G/1	25,4x9,5	215	16,40	5	004440125
444G/1A	25x9	215	16,40	5	004440127
444G/1B	30x11	265	21,00	5	004440130
444G/C	38x10	315	30,50	3	004440133
444G/1C	38x14	315	30,50	3	004440135
444G/2	38,1x12,6	310	30,50	3	004440138
444G/1D	45x14	450	40,00	1	004440145
444G/2D	45x18	450	41,50	1	004440146
444G/3	50,8x16	485	43,50	1	004440150
444G/4	55x16	560	52,00	1	004440155
444G/5A	63,5x19	630	91,50	1	004440163
444G/6	65x18	630	97,00	1	004440165



446/C30

Sortiment mit Gewindebohrern
und Schneideisen, aus Chromstahl,
metrisches Gewinde, komplett mit Zubehör,
im Holzkoffer



446/C30 € 376,00 1 004460055

325x220x35 mm - 3,2 Kg

430 M mm	440 M mm		
3x0,5	3x0,5	435/1,5	444/1
4x0,7	4x0,7		
5x0,8	5x0,8		
6x1	6x1		
8x1,25	8x1,25		
10x1,5	10x1,5		
12x1,75	12x1,75		

446/C48

Sortiment mit Gewindebohrern
und Schneideisen, aus Chromstahl,
metrisches Gewinde, komplett mit Zubehör,
im Holzkoffer



446/C48 € 714,00 1 004460057

580x300x50 mm - 5 Kg

430 M mm	440 M mm	440A M mm		
3x0,5	3x0,5	10x1,5	435/1	444/1
4x0,7	4x0,7	12x1,75	435/3	444/2
5x0,8	5x0,8	14x2		
6x1	6x1	16x2		
8x1,25	8x1,25	18x2,5		
10x1,5		20x2,5		
12x1,75				
14x2				
16x2				
18x2,5				
20x2,5				

446/C110

Sortiment mit Gewindebohrern und Schneideisen, aus Chromstahl, metrisches Gewinde, komplett mit Zubehör, im Holzkoffer



446/C110 € 1.033,00 1 004460060

500x337x60 mm - 8,1 Kg

430 M mm	433 M mm	440/440A M mm	441/441A M mm
2x0,4	6x0,75	2x0,4	6x0,75
3x0,5	7x0,75	3x0,5	7x0,75
4x0,7	8x0,75	4x0,7	8x0,75
5x0,8	8x1	5x0,8	8x1
6x1	9x0,75	6x1	9x0,75
7x1	9x1	7x1	9x1
8x1,25	10x0,75	8x1,25	10x0,75
9x1,25	10x1	9x1,25	10x1
10x1,5	10x1,25	10x1,5	10x1,25
11x1,5	11x0,75	11x1,5	11x0,75
12x1,75	11x1	12x1,75	11x1
14x2	11x1,25	14x2	11x1,25
16x2	12x0,75	16x2	12x0,75
	12x1		12x1
	12x1,25		12x1,25
	12x1,5		12x1,5
	14x1		14x1
	14x1,25		14x1,25
	14x1,5		14x1,5
	16x1		16x1
	16x1,5		16x1,5
	18x1,5		18x1,5



435/0 444/1 436/1
435/3 444/2

446ASF/C29

Sortiment mit Gewindebohrern und Schneideisen, aus Chromstahl, **UNF-Gewinde**, komplett mit Zubehör, im Holzkoffer



446ASF/C29 € 818,00 1 004460070

660x410x50 mm - 6 Kg

433ASF	440ASF		
1/4	1/4	435/1,5	444/1
5/16	5/16	435/3	444/2
3/8	3/8		444/3
7/16	7/16		
1/2	1/2		
9/16	9/16		
5/8	5/8		
3/4	3/4		

446ASC/C37

Sortiment mit Gewindebohrern und Schneideisen, aus Chromstahl, **UNC-Gewinde**, komplett mit Zubehör, im Holzkoffer



446ASC/C37 € 876,00 1 004460080

660x410x50 mm - 6,7 Kg

430ASC	440ASC		
1/4	1/4	435/1,5	444/1
5/16	5/16	435/3	444/2
3/8	3/8		444/3
7/16	7/16		
1/2	1/2		
9/16	9/16		
5/8	5/8		
3/4	3/4		

446ASW/C36

Sortiment mit Gewindebohrern und Schneideisen, aus Chromstahl, **Whitworthgewinde**, komplett mit Zubehör, im Holzkoffer



446ASW/C36 € 605,00 1 004460075

525x310x50 mm - 3,4 Kg

430ASW	440ASW		
1/8	1/8	435/1,5	444/1
5/32	5/32	435/2	444/2
3/16	3/16		
1/4	1/4		
5/16	5/16		
3/8	3/8		
7/16	7/16		
1/2	1/2		

446ASG/C23

Sortiment mit Gewindebohrern und Schneideisen, aus Chromstahl, **Zylindergasgewinde**, komplett mit Zubehör, im Holzkoffer



446ASG/C23 € 1.275,00 1 004460085

700x430x70 mm - 9,8 Kg

433ASG	440ASG		
1/8	1/8	435/3	444/2
1/4	1/4	435/5	444/3
3/8	3/8		444/5A
1/2	1/2		
3/4	3/4		
1"	1"		

 **Beta**

447/C37

Sortiment mit Gewindebohrern und Schneideisen, aus HSS, metrisches Gewinde, komplett mit Zubehör, im Metallkoffer



447/C37 € 763,00 1 004470055

≡ 380x185x35 mm - 3,9 Kg

431 M mm	442 M mm		
3x0,5	3x0,5	435/0	444
4x0,7	4x0,7	435/2	444/0
5x0,8	5x0,8		444/1A
6x1	6x1		444/1B
8x1,25	8x1,25		444/1C
10x1,5	10x1,5		
12x1,75	12x1,75		

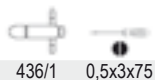

447/C53

Sortiment mit Gewindebohrern und Schneideisen, aus HSS, metrisches Gewinde, komplett mit Zubehör, im Metallkoffer



447/C53 € 1.590,00 1 004470060

≡ 500x235x50 mm - 9 Kg

431 M mm	442 M mm			
3x0,5	3x0,5	435/1,5	444	436/1
4x0,7	4x0,7	435/3	444/0	436/2
5x0,8	5x0,8		444/1A	
6x1	6x1		444/1B	
8x1,25	8x1,25		444/1C	
10x1,5	10x1,5		444/2D	
12x1,75	12x1,75			
14x2	14x2			
16x2	16x2			
18x2,5	18x2,5			
20x2,5	20x2,5			

447/C70

Sortiment mit Gewindebohrern und Schneideisen, aus HSS, metrisches Gewinde, komplett mit Zubehör, im Holzkoffer



447/C70 € 1.995,00 1 004470065

≡ 510x340x70 mm - 7,5 Kg

431 M mm	434 M mm	442 M mm	443 M mm
3x0,5	8x1	3x0,5	8x1
4x0,7	10x1,25	4x0,7	10x1,25
5x0,8	12x1,25	5x0,8	12x1,25
6x1	12x1,5	6x1	12x1,5
7x1	14x1,25	7x1	14x1,25
8x1,25	14x1,5	8x1,25	14x1,5
10x1,5	16x1,5	10x1,5	16x1,5
12x1,75		12x1,75	
14x2		14x2	
16x2		16x2	

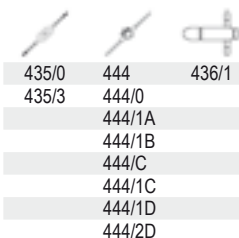

450

Bimetall-Lochsägen, aus HSS-Co 8%

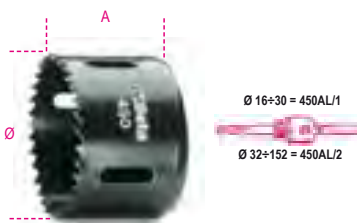

HSS-Co 8%

Ø mm	Ø	A mm	€		
16	(5/8)	57	20,10	1	004500016
17	(11/16)	57	20,10	1	004500017
19	(3/4)	51	20,10	1	004500019
20	-	51	20,10	1	004500020
21	(13/16)	51	20,10	1	004500021
22	(7/8)	51	20,10	1	004500022
24	(15/16)	51	20,10	1	004500024
25	(1")	51	22,20	1	004500025
27	(1"1/16)	51	23,00	1	004500027
29	(1"1/8)	51	23,00	1	004500029
30	(1"3/16)	51	23,00	1	004500030
32	(1"1/4)	51	23,00	1	004500032
33	(1"5/16)	51	23,60	1	004500033

Ø mm	Ø	A mm	€		
35	(1"3/8)	51	26,50	1	004500035
37	(1"7/16)	51	26,50	1	004500037
38	(1"1/2)	44	27,00	1	004500038
40	(1"9/16)	44	28,00	1	004500040
41	(1"5/8)	44	28,50	1	004500041
43	(1"11/16)	44	28,50	1	004500043
44	(1"3/4)	44	29,50	1	004500044
46	(1"13/16)	44	29,50	1	004500046
48	(1"7/8)	44	30,00	1	004500048
51	(2")	44	31,50	1	004500051
52	(2"1/16)	44	35,00	1	004500052
54	(2"1/8)	44	35,00	1	004500054
57	(2"1/4)	44	35,00	1	004500057
59	(2"5/16)	44	37,00	1	004500059
60	(2"3/8)	44	37,00	1	004500060
64	(2"1/2)	44	38,50	1	004500064
65	(2"9/16)	44	38,50	1	004500065
67	(2"5/8)	44	38,50	1	004500067
68	-	44	38,50	1	004500068
70	(2"3/4)	44	39,50	1	004500070
73	(2"7/8)	44	39,50	1	004500073
76	(3")	44	40,50	1	004500076
79	(3"1/8)	44	43,50	1	004500079
83	(3"1/4)	44	45,00	1	004500083
86	(3"3/8)	44	45,00	1	004500086
89	(3"1/2)	44	47,00	1	004500089
92	(3"5/8)	44	49,50	1	004500092
95	(3"3/4)	44	52,00	1	004500095
98	(3"7/8)	44	53,00	1	004500098
102	(4")	44	55,50	1	004500102
105	(4"1/8)	44	60,00	1	004500105
108	(4"1/4)	44	74,50	1	004500108
111	(4"3/8)	44	85,50	1	004500111
114	(4"1/2)	44	101,00	1	004500114
121	(4"3/4)	44	113,00	1	004500121
127	(5")	44	123,00	1	004500127
140	(5"1/2)	44	150,00	1	004500140
152	(6")	44	174,00	1	004500152

450AL

Spannfutter für HSS/Bimetall-Lochsägen

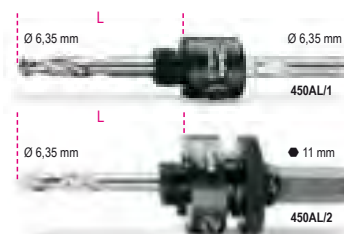

	Ø mm	L mm	€		
450AL/1	16÷30	54	24,70	1	004500210
450AL/2	32÷152	70	57,00	1	004500215

450AD

Adapter für Spannfutter Art. 450AL/1



	Ø mm	€		
450AD	32÷51	9,70	1	004500230



450PA/1

Zentrierbohrer, aus HSS, für Spannfutter 450AL/1



ØxL mm	€	🔧	📦
6,35x105	15,20	1	004500252

450PA/2

Zentrierbohrer, aus HSS, für Spannfutter 450AL/2

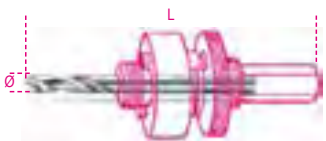

ØxL mm	€	🔧	📦
6,35x80	15,20	1	004500253

450PR

Verlängerung für HSS/Bimetall-Lochsägen



L mm	€	🔧	📦
305	41,50	1	004500255

450/C9

Sortiment mit HSS/Bimetall-Lochsägen und Zubehör, für Elektriker



HSS-Co 8%

450/C9	€	🔧	📦
	292,00	1	004500305

450 Ø 22 - 29 - 35 - 44 - 51 - 64 mm

450AL /1 - /2

450AD

📏 220x160x60 mm - 🏠 1,6 Kg

450/C13

Sortiment mit HSS/Bimetall-Lochsägen und Zubehör, für Metallbauschlosser



HSS-Co 8%

450/C13	€	🔧	📦
	365,00	1	004500310

450 Ø 19 - 22 - 29 - 35 - 38

44 - 51 - 57 - 64 mm

450AL /1 - /2

450PA/1

450AD

📏 215x180x65 mm - 🏠 1,8 Kg

450/C15

Sortiment von Lochsägen und Zubehör für Elektriker



HSS-Co 8%

450/C15	€	🔧	📦
	478,00	1	004500313

450 Ø 16 - 20 - 25 - 32 - 40

51 - 60 - 65 - 70 mm

450AL /1 - /2

450PA /1 - /2

450PR

450AD

📏 420x185x60 mm - 🏠 3,2 Kg

450/C21

Sortiment mit HSS/Bimetall-Lochsägen und Zubehör, für industriellen Gebrauch



HSS-Co 8%

450/C21	€	🔧	📦
	833,00	1	004500315

450 Ø 19 - 22 - 29 - 35 - 38

44 - 51 - 57 - 64 - 76

83 - 92 - 95 - 105 - 114 mm

450AL /1 - /2

450PA /1 - /2

450PR

450AD

📏 420x280x60 mm - 🏠 7 Kg

451

HSS-Lochsägen, vollständig geschliffen

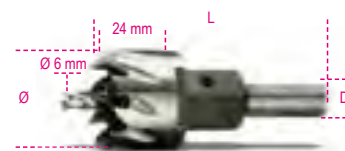

Ø mm	L mm	D mm	€	🔧	📦
12	85	8	30,50	1	004510012
13	85	8	30,50	1	004510013
14	85	8	30,50	1	004510014
15	85	10	30,50	1	004510015
16	85	10	30,50	1	004510016
17	85	10	30,50	1	004510017
18	85	10	30,50	1	004510018
19	85	10	31,50	1	004510019
20	85	10	33,00	1	004510020
21	85	10	35,50	1	004510021
22	85	10	37,50	1	004510022
23	85	10	39,00	1	004510023
24	85	10	40,00	1	004510024
25	85	10	41,50	1	004510025
26	90	10	44,00	1	004510026
27	90	10	45,00	1	004510027
28	90	10	45,50	1	004510028
29	90	10	47,50	1	004510029
30	90	10	48,00	1	004510030
31	90	10	51,00	1	004510031
32	90	10	52,00	1	004510032
33	90	10	53,50	1	004510033
34	90	10	55,50	1	004510034
35	90	10	57,00	1	004510035
36	85	10	59,00	1	004510036
37	85	10	60,00	1	004510037
38	85	10	61,50	1	004510038
39	85	10	63,00	1	004510039
40	85	10	64,00	1	004510040
41	85	10	66,00	1	004510041
42	85	10	69,00	1	004510042
43	85	10	71,50	1	004510043
44	85	10	72,50	1	004510044
45	85	10	74,00	1	004510045
46	85	10	74,00	1	004510046
47	85	10	76,50	1	004510047
48	85	10	80,00	1	004510048
49	85	10	82,50	1	004510049
50	85	10	82,50	1	004510050



451/C

HSS-Lochsägensatz, 8-teilig, vollständig geschliffen



451/C8 € 388,00 1 004510308

Ø 16-18-20-22-25-30-32-35 mm

270x225x70 mm

451GA

Schäfte für HSS-Lochsägen, Art. 451



M	Ø	L	D	€		
mm	mm	mm	mm			
10x1,25	12÷14	57	8	17,20	1	004510101
12x1,25	15÷34	57	10	17,20	1	004510102
14x1,5	35÷50	57	10	21,10	1	004510105

451PA

Zentrierbohrer für HSS/Bimetall-Lochsägen Art. 451



Ø	L	€		
mm	mm			
6	53	9,70	1	004510103

451PR

Verlängerung für HSS-Lochsägen Art. 451



M	Ø	L	Ø1	€		
mm	mm	mm	mm			
12x1,25	15÷34	400	13	74,50	1	004510104
14x1,5	35÷50	400	13	74,50	1	004510108



452

Hartmetall-Lochsägen mit Einsätzen aus Hartmetall

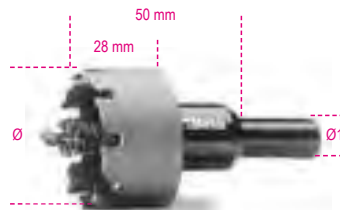

Ø	Ø1	€		
mm	mm			
15	10	125,50	1	004520015
16	10	125,50	1	004520016
17	10	125,50	1	004520017
18	10	125,50	1	004520018
19	10	125,50	1	004520019
20	10	125,50	1	004520020
21	10	125,50	1	004520021
22	10	125,50	1	004520022
23	10	125,50	1	004520023
24	10	125,50	1	004520024
25	10	125,50	1	004520025
26	10	139,00	1	004520026
27	10	139,00	1	004520027
28	10	139,00	1	004520028
29	10	139,00	1	004520029
30	10	139,00	1	004520030
31	10	168,00	1	004520031
32	10	168,00	1	004520032
33	10	168,00	1	004520033
34	10	168,00	1	004520034
35	10	168,00	1	004520035
36	10	195,00	1	004520036
37	10	195,00	1	004520037
38	10	195,00	1	004520038
39	13	195,00	1	004520039
40	13	195,00	1	004520040
41	13	220,00	1	004520041
42	13	220,00	1	004520042
43	13	220,00	1	004520043
44	13	220,00	1	004520044
45	13	220,00	1	004520045
46	13	247,00	1	004520046
47	13	247,00	1	004520047
48	13	247,00	1	004520048
49	13	247,00	1	004520049
50	13	247,00	1	004520050
55	13	281,00	1	004520055
60	13	372,00	1	004520060
65	13	372,00	1	004520065
70	13	433,00	1	004520070
75	13	473,00	1	004520075
80	13	513,00	1	004520080
85	13	579,00	1	004520085
90	13	614,00	1	004520090

452GA

Schäfte für Hartmetall-Lochsägen Art. 452



	Ø	€		
	mm			
452GA/1	15÷21	15,30	1	004520125
452GA/2	22÷38	17,90	1	004520126
452GA/3	39÷100	21,40	1	004520127

460

Zapfenfräser für Bauwesen

- Für Beton, Zement, Natursteine und künstliche Steine
- Max. Bohrtiefe 60 mm



Ø	L	Z	€		
mm	mm	mm			
50	75	6	63,00	1	004600050
60	75	6	74,50	1	004600060
65	75	6	78,00	1	004600065
80	75	6	117,00	1	004600080
90	75	6	123,00	1	004600090
100	75	8	151,00	1	004600100
112	75	8	173,00	1	004600112
125	80	10	215,00	1	004600125
150	80	12	290,00	1	004600150

460PP

Pilotbohrer für Zapfenfräser für Bauwesen Art. 460

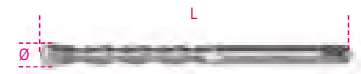

Ø	L	€		
mm	mm			
8	120	7,20	1	004600201

460G

Schäfte für Zapfenfräser Art. 460

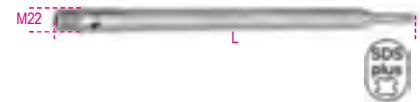

L	€		
mm			
220	39,00	1	004600222
370	54,00	1	004600237
460	86,00	1	004600246

DREHMOMENTVERVIELFÄLTIGER

Unverzichtbare Instrumente zum Anziehen von Muttern und Schrauben mit höheren Drehmomenten als die vom Bediener aufgebracht werden können, auf begrenztem und wenig zugänglichem Raum. Die Drehmomentvervielfältiger vermeiden den Gebrauch von sperrigen und riskanten Verlängerungen und bieten so absolute Sicherheit. Die Produktpalette der Beta Vervielfältiger bietet unterschiedliche Lösungen und Leistungen bis zu einem Höchstwert von 9500 Nm, mit Übersetzungsverhältnissen, die bis zu 135:1 erreichen. Viele Modelle, vor allem jene mit höherer Leistung, sind mit einer Rücklaufsperrung in zwei Richtungen ausgestattet, um zu vermeiden, dass die aufgebauten Spannungen sich in gefährlicher Weise auf den Bediener entladen. Jeder Vervielfältiger Beta ist im Besitz eines Zertifikats, das dessen Prüfung des höchsten Wertes in optimalen Einsatzbedingungen bescheinigt.



Anleitungen für eine korrekte Anwendung

Der Drehmomentvervielfältiger **muss mit einem Drehmomentschlüssel benutzt werden**, um immer die Kontrolle des Ausgangsmomentes zu haben, außerdem müssen immer **Kraftsteckschlüssel** verwendet werden.

Die Übersetzungsverhältnisse eines jeden Vervielfältigers bestimmen den **Multiplikationsfaktor** zwischen Eingangs- und Ausgangsdrehmoment. Beispiel: Vervielfältiger mit Übersetzungsverhältnis 5:1. Bei Anbringen von 100 Nm am Eingang, die auf dem Drehmomentschlüssel eingestellt werden, haben wir am Ausgang 500 Nm als an die Mutter oder die Schraube übertragenen Wert.

Es ist auf jeden Fall immer sicherzustellen, dass alle am Anzug beteiligten Elemente mit einer guten Ausrichtung arbeiten.

Die Verwendung von **Verlängerungen** vermeiden, die sich verdrehen können und so einen Federeffekt erzeugen, der die angewandten Drehmomentwerte ändern.

Stets sicherstellen, dass die **Drehmomentstütze** des Vervielfältigers auf einer resistenten Struktur befestigt oder angesetzt ist, die in der Lage ist, die Reaktionskraft zu ertragen. In der Regel nutzt man ausreichend starre Wände oder Schrauben in der Nähe der Schraube, auf die eingewirkt wird. Die Drehmomentstütze dreht immer in **entgegengesetzter** Richtung zur Anzugsrichtung.



Das Manöver soll flüssig und kontinuierlich durchgeführt werden.

Die beim Anzug erzeugte Spannung muss durch Drehen des Vervielfältigers in umgekehrter Richtung entladen werden, bis er frei läuft; bei Vervielfältigern mit Rücklaufsperrung durch Betätigen des Umkehrhebels.

Die vorab genannten Anweisungen sind auch beim **Abschrauben** zu befolgen.

560/C3

Drehmomentvervielfältiger, für links- und rechtsgängigen Anzug, im Kunststoffkoffer, Vervielfältigung 3,8:1, mit Rücklaufsperr

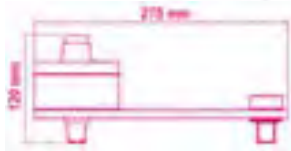

Nm	kgfm	lbf.ft	□	■	kg
1500	150	1110	1/2"	3/4"	3,9

	€	📦	📄
560/C3	1.016,00	1	005600030

☞ 400x260x110 mm

560/C3PLUS

Drehmomentvervielfältiger, für links- und rechtsgängigen Anzug, im Kunststoffkoffer, Vervielfältigung 3,8:1, mit Rücklaufsperr



Nm	kgfm	lbf.ft	□	■	kg
2700	270	1991	3/4"	1"	7,5

	€	📦	📄
560/C3PLUS	1.184,00	1	005600038

☞ 470x240x160 mm

560/C2

Drehmomentvervielfältiger mit Zubehör, für links- und rechtsgängigen Anzug, Vervielfältigung 5:1, im Kunststoffkasten, für intensiven Gebrauch



Nm	Kgfm	lbf.ft	□	■	kg
1300	130	960	1/2"	3/4"	3,8

	€	📦	📄
560/C2	2.065,00	1	005600020
560/2	1.535,00	1	005600002
560/18	48,50	1	005600018
560/19	103,00	1	005600019
560/22	356,00	1	005600022

☞ 310x275x120 mm

560/C4+

Drehmomentvervielfältiger mit Zubehör, für links- und rechtsgängigen Anzug, Vervielfältigung 5:1, mit Abstützwinkel, für intensiven Gebrauch

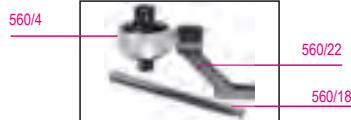

Nm	Kgfm	lbf.ft	□	■	kg
2700	270	2000	3/4"	1"	5

	€	📦	📄
560/C4PLUS	2.030,00	1	005600042
560/4	1.600,00	1	005600004
560/18	48,50	1	005600018
560/22	356,00	1	005600022

☞ 310x275x120 mm

560/C6

Drehmomentvervielfältiger, für links- und rechtsgängigen Anzug im Kunststoffkoffer Vervielfältigung 6,5:1



Nm	kgfm	lbf.ft	□	■	kg
1500	150	1106	1/2"	3/4"	6

	€	📦	📄
560/C6	1.058,00	1	005600160

☞ 400x260x110 mm

560/C12

Vervielfältigung 12:1



Nm	kgfm	lbf.ft	□	■	kg
2500	250	1844	1/2"	1"	7

	€	📦	📄
560/C12	1.520,00	1	005600210

☞ 400x260x110 mm

561/1

Drehmomentvervielfältiger, für links- und rechtsgängigen Anzug, Vervielfältigung 5:1, mit zwei Abstützwinkeln

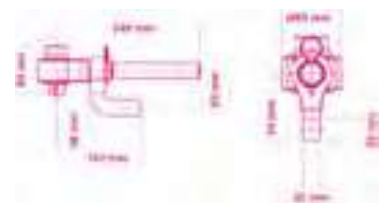

Nm	kgfm	lbf.ft	□	■	kg
1000	100	740	1/2"	3/4"	2,7

	€	📦	📄
561/1	1.480,00	1	005610010

☞ 270x210x70 mm

562-1/VA - 562-2/VA

Drehmomentvervielfältiger für links- und rechtsgängigen Anzug, Vervielfältigung 5,2:1, im Koffer 562VV-A

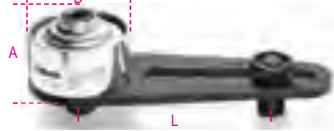

Nm	Kgfm	lbf.ft	□	■	D	A	L min	L max	█
1700	170	1250	3/4	1"	108	95	85	220	8,8

562-1/VA € 3.280,00 1 005620601

Nm	Kgfm	lbf.ft	□	■	D	A	L min	L max	█
3400	340	2500	3/4	1"	119	115	85	265	10,5

562-2/VA € 3.970,00 1 005620602

564-3R/V - 564-4R/V

Drehmomentvervielfältiger, für links- und rechtsgängigen Anzug Vervielfältigung 25:1 mit Rücklaufsperrung im Koffer



Nm	Kgfm	lbf.ft	□	■	D	A	L	█
4000	400	3000	1/2	1"	92	185	205	7,6

564-3R/V € 6.400,00 1 005640613

☞ 390x310x145 mm

Nm	Kgfm	lbf.ft	□	■	D	A	L	█
7000	700	5000	1/2	1 1/2"	120	200	210	13,2

564-4R/V € 7.560,00 1 005640614

☞ 500x435x170 mm

565-1R/VA - 565-2R/VA - 565-3R/VA

Drehmomentvervielfältiger, für links- und rechtsgängigen Anzug, Vervielfältigung 27:1, mit Rücklaufsperrung, im Koffer Art. 562VV-A



Nm	Kgfm	lbf.ft	□	■	D	A	L min	L max	█
1700	170	1250	1/2	1"	108	125	80	215	11,2

565-1R/VA € 5.320,00 1 005650611

Nm	Kgfm	lbf.ft	□	■	D	A	L min	L max	█
3400	340	2500	1/2	1"	119	145	85	265	13,6

565-2R/VA € 6.930,00 1 005650612

Nm	Kgfm	lbf.ft	□	■	D	A	L min	L max	█
3400	340	2500	1/2	1 1/2"	119	145	85	265	14,2

565-3R/VA € 7.330,00 1 005650613

565-4R/VB

Drehmomentvervielfältiger, für links- und rechtsgängigen Anzug, Vervielfältigung 27:1, mit Rücklaufsperrung, im Koffer Art. 565VV-B

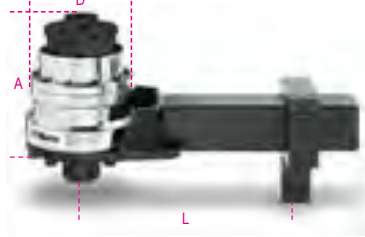

Nm	Kgfm	lbf.ft	□	■	D	A	L min	L max	█
6000	600	4500	1/2	1 1/2"	144	180	125	335	22,4

565-4R/VB € 8.270,00 1 005650614

565-5R/VB

Drehmomentvervielfältiger, für links- und rechtsgängigen Anzug, Vervielfältigung 27:1, mit Rücklaufsperrung, im Koffer Art. 565VV-B

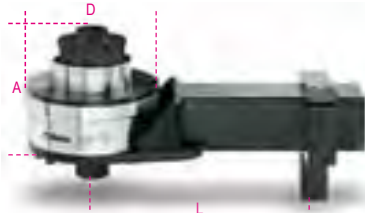

Nm	Kgfm	lbf.ft	□	■	D	A	L min	L max	█
9500	950	7000	3/4	1 1/2"	184	180	155	355	30,4

565-5R/VB € 14.080,00 1 005650615

567-4R/VB

Drehmomentvervielfältiger, für links- und rechtsgängigen Anzug, Vervielfältigung 135:1, mit Rücklaufsperrung, im Koffer 565VV-B

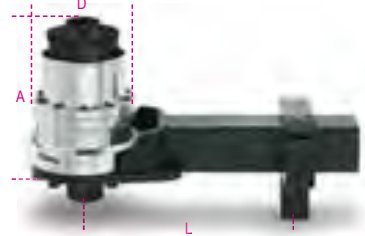

Nm	Kgfm	lbf.ft	□	■	D	A	L min	L max	█
6000	600	4500	1/2	1 1/2"	144	210	125	335	24,4

567-4R/VB € 9.190,00 1 005670614

567-5R/VB

Drehmomentvervielfältiger, für links- und rechtsgängigen Anzug, Vervielfältigung 135:1, mit Rücklaufsperrung, im Koffer 565VV-B

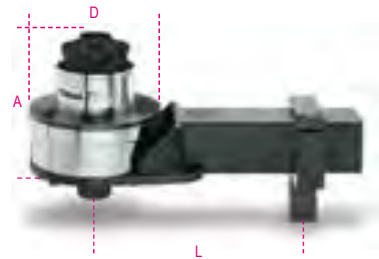

Nm	Kgfm	lbf.ft	□	■	D	A	L min	L max	█
9500	950	7000	1/2	1 1/2"	184	210	155	350	32,4

567-5R/VB € 15.780,00 1 005670615

562VV-A

Koffer für Vervielfältiger, aus hoch widerstandsfähigem Polypropylen, mit Schwamm Innenabmessungen 380x270x180mm



562VV-A € 281,00 1 005620501

562/1-562/2-564/3R
564/4R-565/1R-565/2R
565/3R

☞ 410x340x205 mm - █ 3,5 kg

565VV-B

Koffer für Vervielfältiger, aus hoch widerstandsfähigem Polypropylen, mit Schwamm Innenabmessungen 480x370x205mm



565VV-B € 380,00 1 005650502

565/4R-565/5R
567/4R-567/5R

☞ 520x435x230 mm - █ 5,4 kg



Zur Betätigung der Drehmomentschlüssel müssen diese in der Mitte des Griffs gehalten werden, um nicht das Hebelverhältnis zu ändern. Die Drehmomentschlüssel müssen flüssig und kontinuierlich, ohne Rucke, betätigt werden.

Die Einstellskala muss nach dem Gebrauch nullgestellt werden, um die Anzugsgenauigkeit nicht zu beeinträchtigen. **Für die Schlüssel der Serie Zero-Reset ist dies nicht erforderlich.**

Beta bietet eine breitgefächerte Auswahl an Schlüsseln mit 4 unterschiedlichen Betriebsarten.

MODELLE MIT SCHLEPPZEIGER

Das ausgeübte Drehmoment wird mittels des Drucks einer Spiralfeder direkt an die Leseanzeige übertragen. Das angewandte Drehmoment kann in Echtzeit gelesen werden, dank eines Anzeigezeigers. Ein zweiter Zeiger kann auf dem Wert des Solldrehmoments positioniert werden. Bei Erreichen des Solldrehmoments wird der zweite Zeiger vom Hauptzeiger angekoppelt und zeichnet den erreichten Spitzenwert auf. Diese Modelle garantieren absolute Präzision und Lebensdauer.

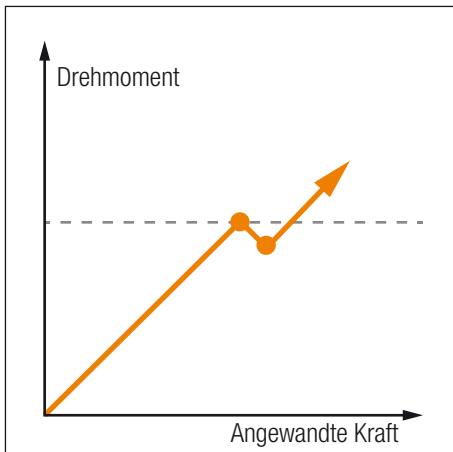

MODELLE MIT SIGNALGEBUNG

Es sind die am meisten verbreiteten Modelle aufgrund ihrer Bedienfreundlichkeit. Die Vorwahl des Drehmoments erfolgt schnell durch Vorspannen der Feder. Das Drehmoment erhöht sich mit der Steigerung der ausgeübten Kraft. Bei Erreichen des gewünschten Drehmoments hat man ein plötzliches Absinken und der Schlüssel übt für etwa 3-5° kein Anzugsmoment aus. Wenn der Bediener die Bewegung nicht unterbricht, erhöht sich das Drehmoment immer mehr und überschreitet die gewünschten Werte.

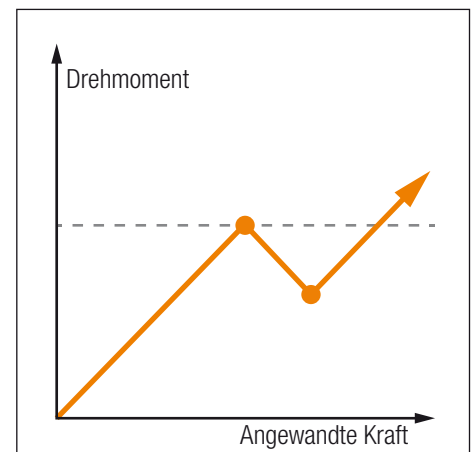

MODELLE MIT AUTOMATISCHER LANGWEGLÖSUNG

Sie funktionieren wie die Modelle mit Auslösung, aber wenn das Drehmoment erreicht wird, hat man ein sichtbares Absinken (etwa 20°) des Hebelarms. Der Bediener hat daher mehr Spielraum, um die Anwendung der Kraft einzustellen. Diese Modelle werden normalerweise für hohe Drehmomentwerte mit sehr langen Hebelarmen verwendet.

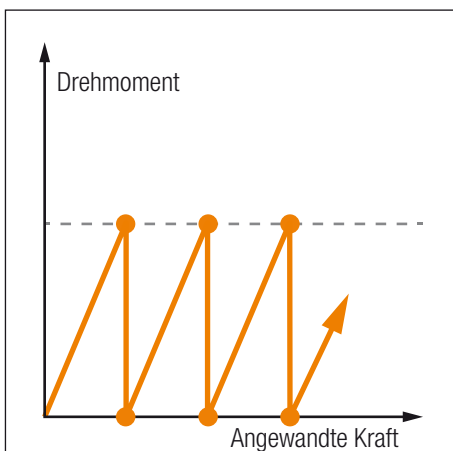

MODELLE MIT AUSLÖSUNG

Bei Erreichen des vorgewählten Drehmoments, unterbricht das Auslösen des Mechanismus die Anwendung des Drehmoments und verursacht so die "Leer"-Drehung des Werkzeugs. Auf diese Weise ist es unmöglich, Anzüge mit Drehmomenten, die das Solldrehmoment überschreiten, durchzuführen. Wird die Kraft weiterhin angewandt, wiederholt sich derselbe Zyklus. Diese Modelle sind ideal für Vorgänge in Serie im Bereich der niedrigen Drehmomente (elektronische und mikromechanische), wo es notwendig ist, leicht zerbrechliche Komponenten oder kleine Komponenten nicht zu beschädigen.

EINSATZBEREICHE DREHMOMENTSCHLÜSSEL

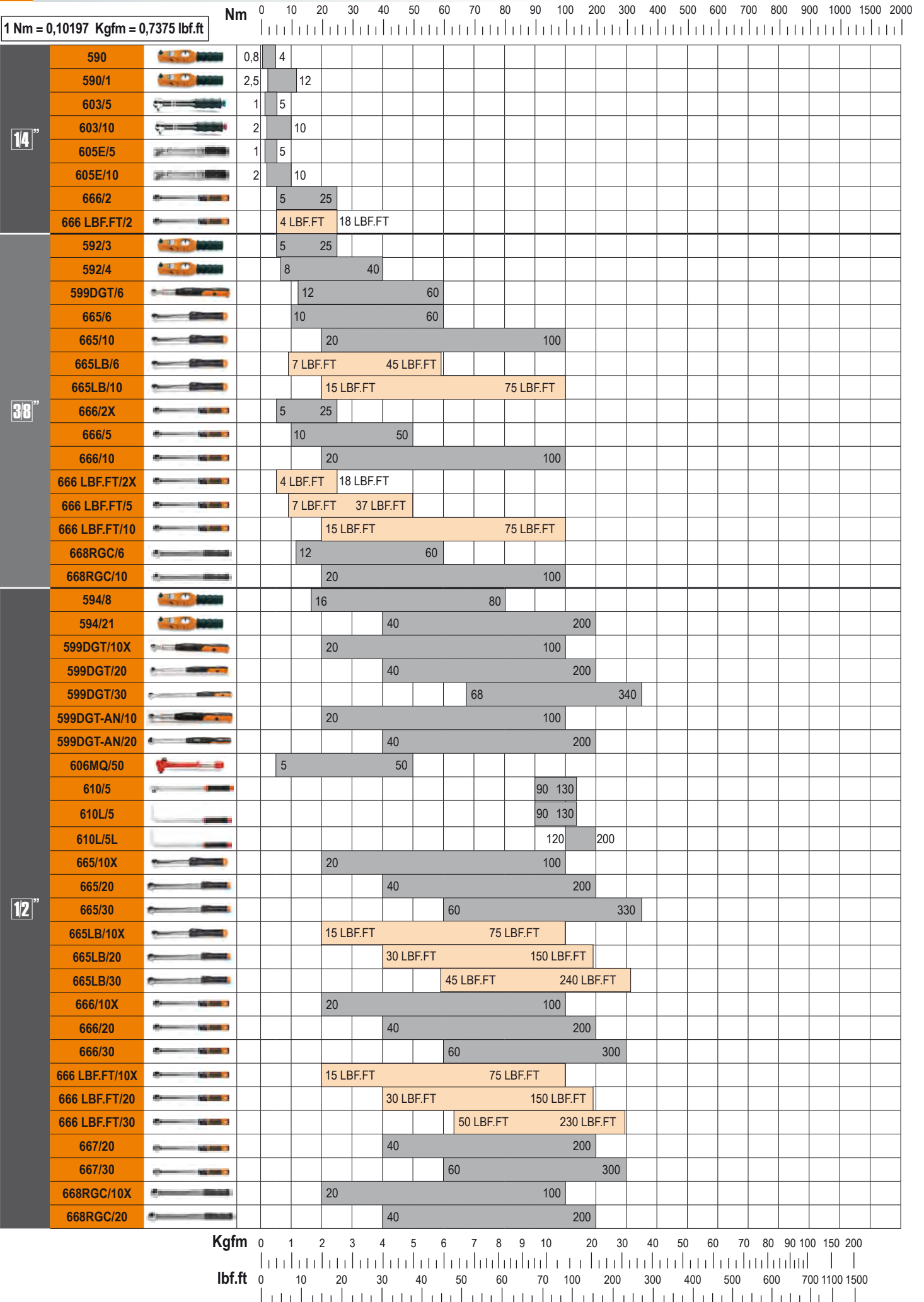

Beta

581

Drehmomentschrauber mit Auslösung, ohne Messteilung
Geeignet für rechtsgängigen Anzug
Genauigkeit: ±6%
(Zur Verwendung mit Art. 588 - 682)



UNI EN ISO 6789

Nm	gfm	Ø	g
1,2÷6	120÷600	1/4"	275

581	€ 332,00	1	005810001
-----	----------	---	-----------

583

Drehmomentschrauber mit Auslösung, Geeignet für rechtsgängigen Anzug
Genauigkeit: ±6%



UNI EN ISO 6789

Nm	gfm	Ø	g	mm
0,3÷1,5	30÷150	1/4"	240	0,05

583/1,5	€ 373,00	1	005830015
---------	----------	---	-----------

Nm	gfm	Ø	g	mm
0,6÷3	60÷300	1/4"	240	0,1

583/3	€ 373,00	1	005830030
-------	----------	---	-----------

Nm	gfm	Ø	g	mm
1,2÷6	120÷600	1/4"	350	0,2

583/6	€ 373,00	1	005830060
-------	----------	---	-----------

583/C31

1 Drehmomentschrauber, 8 Sechskant-Steckschlüssel, 20 Schraub-Einsätze und 2 Zubehörteile

1/4"



583/C31	€ 520,00	1	005830931
---------	----------	---	-----------

583/6	1.2 - 6 Nm
900	4-5-5,5-6-7-8-9-10 mm
860LP	0,6x4,5 - 1x5,5 - 1,2x6,5 mm
860PH	PH1 - PH2 (x2) - PH3
860PE	2-2,5-3-4-5 mm
860TX	T9-T10-T15-T20-T25-T27-T30-T40
882P/80	80 mm
892/0	● 1/4 ■ 1/4

270x120x45 mm - 1,2 kg

590 - 592

Drehmomentschlüssel mit Schleppeizer
Geeignet für links- und rechtsgängigen Anzug
Genauigkeit: ±4%

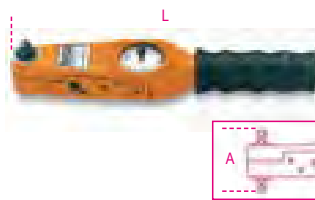

UNI EN ISO 6789

Nm	Kgfm	lbf.in	Ø	A mm	L mm	kg	mm
0,3÷4	0,03÷0,4	3÷35	1/4	60	253	0,52	0,1

590	€ 880,00	1	005900001
-----	----------	---	-----------

Nm	Kgfm	lbf.in	Ø	A mm	L mm	kg	mm
0,5÷13,5	0,05÷1,35	4÷120	1/4	60	253	0,52	0,5

590/1	€ 880,00	1	005900003
-------	----------	---	-----------

Nm	Kgfm	lbf.in	Ø	A mm	L mm	kg	mm
1÷27	0,1÷2,7	10÷240	3/8	70	253	0,52	1,0

592/3	€ 874,00	1	005920005
-------	----------	---	-----------

Nm	Kgfm	lbf.in	Ø	A mm	L mm	kg	mm
3÷40	0,3÷4	20÷360	3/8	70	253	0,52	1,0

592/4	€ 874,00	1	005920007
-------	----------	---	-----------

594

Drehmomentschlüssel mit Schleppeizer
Geeignet für links- und rechtsgängigen Anzug
Genauigkeit: ±4%

1/2"



UNI EN ISO 6789

Nm	Kgfm	lbf.ft	Ø	A mm	L mm	kg	mm
6÷80	0,6÷8	5÷60	1/2	85	455	1,35	2,0

594/8	€ 1.325,00	1	005940011
-------	------------	---	-----------

Nm	Kgfm	lbf.ft	Ø	A mm	L mm	kg	mm
20÷215	2÷21,5	15÷160	1/2	85	530	1,40	5,0

594/21	€ 1.325,00	1	005940015
--------	------------	---	-----------

Drehmomentkalibrierungs-Service am Ende der Preisliste

596 - 598

Drehmomentschlüssel mit Schleppeizer
Geeignet für links- und rechtsgängigen Anzug
Genauigkeit: ±4%

Das Erreichen des vorbestimmten Anziehdrehmoments wird über eine Leuchtanzeige und einen aussetzenden Ton signalisiert.



UNI EN ISO 6789

Nm	Kgfm	lbf.ft	Ø	A mm	L mm	kg	mm
80÷400	8÷40	60÷300	3/4	111	710	3,2	10

596/40SL	€ 2.190,00	1	005960010
----------	------------	---	-----------

Nm	Kgfm	lbf.ft	Ø	A mm	L mm	kg	mm
160÷800	16÷80	120÷600	3/4"	115	1025	4,85	20

596/80SL	€ 2.750,00	1	005960020
----------	------------	---	-----------

Nm	Kgfm	lbf.ft	Ø	A mm	L mm	kg	mm
200÷2000	20÷200	150÷1500	1"	135	1930	16,70	50

598/200SL	€ 5.740,00	1	005980022
-----------	------------	---	-----------

Beta



599DGT

Elektronischer Drehmomentschlüssel mit Umschaltknarre, zum rechts- (Genauigkeit ±2%) und linksgängigen (Genauigkeit ±3%) Anziehen

- Doppelanzeige von Annäherung und Sperre: Peak-/Track-Mode
- Das Erreichen des voreingestellten Drehmoments wird durch Lichtsignale und ein intermittierendes Tonsignal angezeigt
- Spannungsversorgung: 2 Batterien AA 1,5V (inbegriffen)



UNI EN ISO 6789

Nm	Kgfm	lbf.ft	■	D	A	L	■	kg	mm
12÷60	1,2÷6	8÷44	3/8	30	33	413	0,9	0,1	

599DGT/6	€ 466,00	1	005990003
----------	----------	---	-----------

Nm	Kgfm	lbf.ft	■	D	A	L	■	kg	mm
20÷100	2÷10	15÷80	1/2	30	37	413	0,9	0,1	

599DGT/10X	€ 479,00	1	005990010
------------	----------	---	-----------

Nm	Kgfm	lbf.ft	■	D	A	L	■	kg	mm
40÷200	4÷20	30÷150	1/2	40	43	520	2	0,1	

599DGT/20	€ 498,00	1	005990020
-----------	----------	---	-----------

Nm	Kgfm	lbf.ft	■	D	A	L	■	kg	mm
68÷340	6,8÷34	58÷280	1/2	40	43	640	2,35	0,1	

599DGT/30	€ 537,00	1	005990030
-----------	----------	---	-----------

599DGT-AN

Elektronischer Drehmomentschlüssel mit Drehmoment- und Winkelanzeige und Umschaltknarre, zum rechts- (Genauigkeit +/- 2%) und linksgängigen (Genauigkeit +/- 3%) Anziehen

- Anzugsarten: Drehmoment, Winkel, Drehmoment/Winkel
- Doppelanzeige von Annäherung und Sperre: Peak-/Track-Mode
- Das Erreichen des voreingestellten Drehmoments/Winkels wird durch Lichtsignale und ein intermittierendes Tonsignal angezeigt
- Speichern der Anzugsdaten (bis zu 1600 Werte)
- 9 voreinstellbare Drehmoment-/Winkelwerte
- Sicherheitsblockierung der Tasten
- Mögliche Verknüpfung des Schlüssels mit 16 Benutzern mittels Nutzer-ID
- Rückverfolgbarkeit der Anzugsdaten. Die Software ermöglicht das Speichern von Datum und Uhrzeit, Seriennummer des Werkzeugs, eingestelltem Anzugswert, erzielttem Wert und die Verknüpfung dieser Daten mit der Nutzer-ID
- Rutschfester Bimaterial-Griff
- Inklusiv: 2 AA Batterien - 1,5V, USB-Kabel und Software



UNI EN 26789
ISO 6789

Nm	Kgfm	lbf.ft	■	D	A	L	■	kg	mm
20÷100	2÷10	15÷80	1/2	30	33	413	0,9	0,1	

599DGT-AN/10	€ 874,00	1	005990610
--------------	----------	---	-----------

Nm	Kgfm	lbf.ft	■	D	A	L	■	kg	mm
40÷200	4÷20	30÷150	1/2	40	43	520	1,3	0,1	

599DGT-AN/20	€ 922,00	1	005990620
--------------	----------	---	-----------

Drehmomentkalibrierungs-Service am Ende der Preisliste



600

Drehwinkel-Messgerät

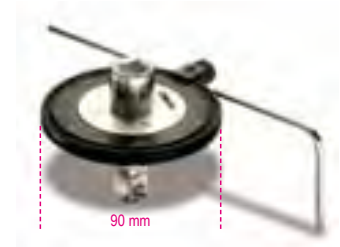

	□	■	€	1	006000001
600/1	1/2	1/2	186,50	1	006000001
600/2	3/4	3/4	211,00	1	006000002

601C

Drehwinkel-Messgerät mit Digitalanzeige

Auf das Erreichen des eingestellten Winkels wird durch Leuchtanzeigen und durch Buzzer hingewiesen



601C	€ 251,00	1	006010100
------	----------	---	-----------

85x80x87 mm - 70 g

601CA

Digitales Drehwinkelmessgerät für Drehmoment- und Drehwinkelanzug

Das Erreichen des Soll Drehmoments oder des Soll Drehwinkels wird durch Leuchtanzeigen oder durch ein akustisches Signal angezeigt.



	□	■	Nm	■	€	1	006010120
1/2"	1/2"	40÷200	0,1	443,00	1	006010120	

120x90x120 mm - 240 g

603

Drehmomentschlüssel mit Auslösung
Für rechtsgängigen Anzug
Genauigkeit: ±6%



UNI EN ISO 6789

Nm	Kgfm	lbf.in	□	A	L	g	⚙️
1÷5	0,1÷0,5	10÷45	1/4	35	195	235	0,05

603/5 € 755,00 1 006030005

Nm	Kgfm	lbf.in	□	A	L	g	⚙️
2÷10	0,2÷1,0	18÷90	1/4	35	195	235	0,1

603/10 € 773,00 1 006030010

604B

Drehmomentschlüssel mit automatischer
Langwegauslösung
für links- und rechtsgängigen Anzug
Genauigkeit: ± 6%



UNI EN ISO 6789

Nm	Kgfm	lbf.in	∅	L	g	⚙️
1÷5	0,1÷0,5	10÷45	8	220	290	0,025

604B/5 € 490,00 1 006040015

Nm	Kgfm	lbf.in	∅	L	g	⚙️
2÷10	0,2÷1,0	18÷90	8	220	300	0,05

604B/10 € 490,00 1 006040020

605E

Drehmomentschlüssel mit Signalgebung,
mit Einfachknarre,
für links- und rechtsgängigen Anzug
Genauigkeit: ± 6%

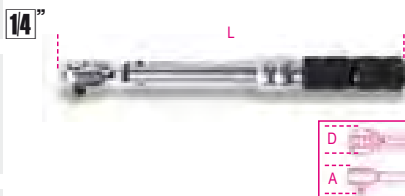

UNI EN ISO 6789

Nm	Kgfm	lbf.in	□	A	L	g	⚙️
1÷5	0,1÷0,5	10÷45	1/4	20	190	180	0,05

605E/5 € 252,00 1 006050105

Nm	Kgfm	lbf.in	□	A	L	g	⚙️
2÷10	0,2÷1,0	18÷90	1/4	20	190	180	0,1

605E/10 € 263,00 1 006050110

605DGT/2

Elektronischer Drehmomentschlüssel
mit Umschaltknarre
für links- und rechtsgängigen Anzug
Genauigkeit: ± 3% rechtsgängig
± 4% linksgängig
• Doppelanzeige von Annäherung und Sperre: Peak-/Track-Mode
• Das Erreichen des voreingestellten Drehmoments wird durch ein Leuchtzeichen und einen intermittierenden Ton angezeigt.
• Stromversorgung durch 1 Batterie 1,5 V AAA (im Lieferumfang)



Nm	Kgcm	lbf.ft	□	D	A	L	g	⚙️
4÷20	10÷204	0,75÷14,75	1/4	20	20	210	175	0,01

605DGT/2 € 302,00 1 006050302

610/5

Drehmomentschlüssel mit Signalgebung
mit Umschaltknarre
für rechtsgängigen Anzug,
mit 5 voreingestellten Werten,
Genauigkeit: ± 4%

Wählbare Drehmomente
90 - 100 - 110 - 120 - 130 Nm



UNI EN ISO 6789

Nm	□	D	A	L	g	⚙️
90÷130	1/2	42	39	490	1330	10

610/5 € 210,00 1 006100025

610L/5

Drehmomentschlüssel mit Signalgebung
mit L-Hebel
für rechtsgängigen Anzug,
mit 5 voreingestellten Werten,
Genauigkeit: ± 4%

Wählbare Drehmomente
90 - 100 - 110 - 120 - 130 Nm



UNI EN ISO 6789

Nm	□	L	L1	g	⚙️
90÷130	1/2	470	80	1350	10

610L/5 € 186,50 1 006100125

610L/5L

Drehmomentschlüssel mit Signalgebung
mit L-Hebel,
für rechtsgängigen Anzug,
mit 5 voreingestellten Werten,
Genauigkeit: ± 4%

Wählbare Drehmomente:
120 - 140 - 160 - 180 - 200 Nm



UNI EN ISO 6789

Nm	□	L	L1	g	⚙️
120÷200	1/2	470	80	1400	20

610L/5L € 192,00 1 006100150

611

Umschaltknarren
für Drehmomentschlüssel Art. 604B/5 und Art.
604B/10
Außenvierkant 8 mm



611 € 176,50 1 006110001

**Drehmomentkalibrierungs-Service
am Ende der Preisliste**

612 ÷ 614

Umschaltknarren
für Drehmomentschlüssel



Die Artikel 612 und 612X dürfen nicht
für Anziehungsmomente von über 100 Nm
verwendet werden.

612 3/8 66 32 € 79,50 2 006120000

612X 1/2 66 32 € 84,00 2 006120010

614 1/2 71 32 € 91,50 2 006140000

614X 3/4 71 32 € 100,00 2 006140004

614/50

Einfachknarre für Drehmomentschlüssel



mm	mm	L mm	LA mm	€		
614/50	1/2	71	32	84,00	2	006140002

Für die Ersatzdrehvorrichtungen der Knarren, s. Details nach Artikel 929/C8

615

Umschaltknarren für Drehmomentschlüssel, mit rechtwinkligem Anschluss



mm	mm	L mm	LA mm	€		
9x12	3/8	53	28,8	67,00	1	006150010
9x12	1/2	53	28,8	67,00	1	006150020
14x18	1/2	70	39,8	67,00	1	006150120

616 - 617 - 619

Außenvierkante für Drehmomentschlüssel



mm	mm	L mm	LA mm	€		
616	1/4	61	32	62,50	1	006160000
617	3/8	61	32	62,50	1	006170000
619	1/2	63	32	62,50	1	006190000

621

Zubehör Einsatzhalter für Drehmomentschlüssel, mit rechtwinkligem Anschluss



mm	mm	L mm	LA mm	€		
621P/14	9x12	1/4	43 28,8	80,00	1	006210000
* 621P/5/16	14x18	5/16	52,5 32,5	122,50	1	006210110

*Achtung! Den einzustellenden Drehmomentwert wie in der Tabelle im unteren Abschnitt der Preisliste neu berechnen

622

Umschaltknarren für Drehmomentschlüssel, mit rundem Anschluss, Ø 22 mm

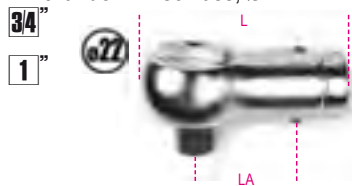

mm	mm	L mm	LA mm	€		
622 3/4	3/4	110	56	223,00	1	006220019
622 1"	1	110	56	271,00	1	006220024

641

Maulschlüssel-Einsätze für Drehmomentschlüssel Art. 604B/5 und Art. 604B/10

Außenvierkant 8 mm



mm	L mm	€		
4	37	95,00	1	006410003
5	37	95,00	1	006410004
5,5	37	95,00	1	006410005
6	37	95,00	1	006410006
7	37	95,00	1	006410007
8	42	95,00	1	006410008
9	42	95,00	1	006410009
10	42	95,00	1	006410010

642

Maulschlüssel-Einsätze für Drehmomentschlüssel



mm	L mm	LA mm	A mm	€		
8	54	32	22	67,50	1	006420008
10	57	32	26	67,50	1	006420010
12	58	32	30	67,50	1	006420012
13	58	32	30	67,50	1	006420013
14	59	32	32	67,50	1	006420014
15	59	32	35	67,50	1	006420015
16	59	32	38	67,50	1	006420016
17	60	32	39	67,50	1	006420017
18	61	32	42	67,50	1	006420018
19	61	32	43	67,50	1	006420019
20	61	32	50	105,00	1	006420020
21	62	32	53	105,00	1	006420021
22	62	32	53	115,00	1	006420022
23	65	32	53	115,00	1	006420023
24	63	32	53	115,00	1	006420024
25	64	32	53	141,00	1	006420125
26	64	32	59	141,00	1	006420026
27	65	32	59	141,00	1	006420027
28	66	32	64	141,00	1	006420028
30	66	32	66	141,00	1	006420030
32	67	32	66	141,00	1	006420032
* 36	76	42	80	192,50	1	006420036
* 40	77	52	95	192,50	1	006420040
* 41	78	52	95	192,50	1	006420041
* 46	90	52	95	232,50	1	006420046

*Achtung! Den einzustellenden Drehmomentwert wie in der Tabelle im unteren Abschnitt der Preisliste neu berechnen

643

Maulschlüssel-Einsätze für Drehmomentschlüssel, rechteckiger Anschluss



mm	mm	L mm	LA mm	€		
7	9x12	37	28,8	59,00	1	006430007
8	9x12	37	28,8	59,00	1	006430008
10	9x12	39	28,8	59,00	1	006430010
12	9x12	39	28,8	59,00	1	006430012
13	9x12	39	28,8	59,00	1	006430013
14	9x12	43	28,8	60,00	1	006430014
15	9x12	43	28,8	60,00	1	006430015
16	9x12	43	28,8	60,00	1	006430016
17	9x12	43	28,8	60,00	1	006430017
* 18	9x12	47	36,3	60,00	1	006430018
* 19	9x12	51	36,3	60,00	1	006430019
* 21	9x12	52	36,3	93,00	1	006430021
* 22	9x12	52	36,3	93,00	1	006430022

*Achtung! Den einzustellenden Drehmomentwert wie in der Tabelle im unteren Abschnitt der Preisliste neu berechnen

mm	mm	L mm	LA mm	€		
13	14x18	60	39,8	62,00	1	006430113
14	14x18	58	39,8	62,00	1	006430114
15	14x18	60	39,8	62,00	1	006430115
16	14x18	60	39,8	62,50	1	006430116
17	14x18	60	39,8	62,50	1	006430117
18	14x18	61	39,8	62,50	1	006430118
19	14x18	61	39,8	62,50	1	006430119
21	14x18	61	39,8	98,00	1	006430121
22	14x18	62	39,8	98,00	1	006430122
24	14x18	64	39,8	98,00	1	006430124
* 27	14x18	68	44,8	110,50	1	006430127
* 30	14x18	77	49,8	111,00	1	006430130
* 32	14x18	77	49,8	111,00	1	006430132
* 34	14x18	80	54,8	176,50	1	006430134
* 36	14x18	83	54,8	176,50	1	006430136
* 38	14x18	83	54,8	176,50	1	006430138
* 41	14x18	91	64,8	176,50	1	006430141

*Achtung! Den einzustellenden Drehmomentwert wie in der Tabelle im unteren Abschnitt der Preisliste neu berechnen

644

Maulschlüssel-Einsätze für Drehmomentschlüssel, mit rundem Anschluss, Ø 22 mm



mm	L mm	LA mm	A mm	€		
22	91	56	52	115,00	1	006440022
24	91	56	52	115,00	1	006440024
27	94	56	64	141,00	1	006440027
30	94	56	64	141,00	1	006440030
32	97	56	75,5	141,00	1	006440032
34	97	56	75,5	141,00	1	006440034
36	97	56	75,5	192,50	1	006440036
41	103,5	56	94	192,50	1	006440041
46	115,5	56	94	232,50	1	006440046

650A

Einmenschlüssel
für Drehmomentschlüssel,
mit rechtwinkligem Anschluss



A min-max mm	■ mm	L mm	LA mm	€	🔧	📄
* 5-27	9x12	93	74,3	108,50	1	006500027
* 5-30	9x12	106	85,3	108,50	1	006500030
* 5-30	14x18	115	89	110,50	1	006500130
* 10-41	14x18	127	100	114,00	1	006500141

*Achtung! Den einzustellenden Drehmomentwert wie in der Tabelle im unteren Abschnitt der Preisliste neu berechnen

650H

Hakenschlüssel
für Drehmomentschlüssel
mit rechtwinkligem Anschluss

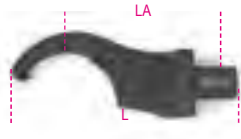

⊙ mm	■ mm	L mm	LA mm	€	🔧	📄
* 28-36	14x18	122	92	57,50	1	006500928
* 40-45	14x18	129	92	57,50	1	006500940
* 50-55	14x18	129	92	57,50	1	006500950
* 58-62	14x18	135	92	61,00	1	006500958
* 68-75	14x18	139	92	66,50	1	006500968
* 80-90	14x18	145	92	66,50	1	006500980

*Achtung! Den einzustellenden Drehmomentwert wie in der Tabelle im unteren Abschnitt der Preisliste neu berechnen

652

Ringschlüsseleinsätze
für Drehmomentschlüssel



⊙ mm	L mm	LA mm	€	🔧	📄
8	58	32	73,00	1	006520008
10	58	32	73,00	1	006520010
12	58	32	73,00	1	006520012
13	58	32	73,00	1	006520013
14	58	32	73,00	1	006520014
15	62	32	73,00	1	006520015
16	63	32	73,00	1	006520016
17	64	32	73,00	1	006520017
18	65	32	73,00	1	006520018
19	65	32	73,00	1	006520019
21	67	32	110,00	1	006520021
22	68	32	116,00	1	006520022
24	69	32	139,00	1	006520024
26	71	32	156,50	1	006520026
27	71	32	156,50	1	006520027
30	73	32	156,50	1	006520030
32	74	32	156,50	1	006520032

653

Ringschlüsseleinsätze
für Drehmomentschlüssel,
rechteckiger Anschluss

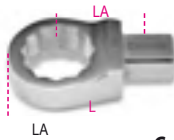

⊙ mm	■ mm	L mm	LA mm	€	🔧	📄
7	9x12	40	28,8	63,50	1	006530007
8	9x12	40	28,8	63,50	1	006530008
10	9x12	43	28,8	63,50	1	006530010
12	9x12	44	28,8	63,50	1	006530012
13	9x12	44	28,8	63,50	1	006530013
14	9x12	45	28,8	63,50	1	006530014
15	9x12	46	28,8	63,50	1	006530015
16	9x12	47	28,8	64,00	1	006530016
17	9x12	47	28,8	64,00	1	006530017
18	9x12	48	28,8	64,00	1	006530018
19	9x12	49	28,8	64,00	1	006530019
21	9x12	51	28,8	66,50	1	006530021
22	9x12	51	28,8	66,50	1	006530022

⊙ mm	■ mm	L mm	LA mm	€	🔧	📄
13	14x18	61	39,8	70,00	1	006530113
14	14x18	61	39,8	70,00	1	006530114
15	14x18	62	39,8	70,00	1	006530115
16	14x18	63	39,8	70,50	1	006530116
17	14x18	64	39,8	70,50	1	006530117
18	14x18	64	39,8	70,50	1	006530118
19	14x18	66	39,8	70,50	1	006530119
21	14x18	66	39,8	101,50	1	006530121
22	14x18	67	39,8	101,50	1	006530122
24	14x18	69	39,8	127,00	1	006530124
* 27	14x18	76	44,8	127,00	1	006530127
* 30	14x18	77	44,8	127,00	1	006530130
* 32	14x18	79	44,8	127,00	1	006530132
* 34	14x18	80	44,8	180,00	1	006530134
* 36	14x18	80	44,8	180,00	1	006530136
* 38	14x18	90	49,8	184,00	1	006530138
* 41	14x18	90	49,8	184,00	1	006530141

*Achtung! Den einzustellenden Drehmomentwert wie in der Tabelle im unteren Abschnitt der Preisliste neu berechnen

654

Ringschlüsseleinsätze
für Drehmomentschlüssel,
mit rundem Anschluss, Ø 22 mm



⊙ mm	L mm	LA mm	A mm	€	🔧	📄
22	98,5	56	38	116,00	1	006540022
24	98,5	56	38	139,00	1	006540024
27	102,8	56	46,5	156,50	1	006540027
30	102,8	56	46,5	156,50	1	006540030
32	106,5	56	55	156,50	1	006540032
34	106,5	56	55	156,50	1	006540034
36	106,5	56	55	203,50	1	006540036
41	115,5	56	72	203,50	1	006540041
46	115,5	56	72	220,50	1	006540046

659/15

Kupplung mit rechtwinkligem Anschluss
Mutter 14x18 mm und Schraube 9x12 mm



L mm	□ mm	■ mm	LA mm	€	🔧	📄
* 56	14x18	9x12	39	92,00	1	006590815

*Achtung! Den einzustellenden Drehmomentwert wie in der Tabelle im unteren Abschnitt der Preisliste neu berechnen



Die Torsionslast muss unbedingt angemessen und stufenweise aufgebracht werden, um Bruch oder zufällige Beschädigung zu vermeiden.

659/16

Kupplung mit rechtwinkligem Anschluss
Mutter 9x12 mm und Schraube 14x18 mm



L mm	□ mm	■ mm	LA mm	€	🔧	📄
* 52	9x12	14x18	31	78,00	1	006590816

*Achtung! Den einzustellenden Drehmomentwert wie in der Tabelle im unteren Abschnitt der Preisliste neu berechnen

665

Mechanischer Drehmomentschlüssel mit digitaler Anzeige und Umschaltknarre zum rechtsgängigen Anziehen, Anziehgengerigkeit ±3%

- Automatisches Ausschalten nach 10 Sek. unter der Schwelle des Mindestdrehmoments
- Das Erreichen des maximalen Anzugsmoments wird durch Blinken des Displays angezeigt
- Das Display bleibt mit dem eingestellten Drehmoment eingeschaltet
- Lesen des Drehmo



UNI EN ISO 6789

Nm	■	D mm	A mm	L mm	g	🔧
10÷60	3/8	30	33	335	655	0,1
665/6	€	🔧	📄	279,00	1	006650006

Nm	■	D mm	A mm	L mm	g	🔧
20÷100	3/8	30	33	375	725	0,1
665/10	€	🔧	📄	281,00	1	006650010

Nm	■	D mm	A mm	L mm	g	🔧
20÷100	1/2	30	37	375	725	0,1
665/10X	€	🔧	📄	287,00	1	006650011

Nm	■	D mm	A mm	L mm	g	🔧
40÷200	1/2	40	43	470	995	0,5
665/20	€	🔧	📄	306,00	1	006650020

Nm	■	D mm	A mm	L mm	g	🔧
60÷330	1/2	40	43	590	1260	0,5
665/30	€	🔧	📄	347,00	1	006650030

665LB

Mechanischer Drehmomentschlüssel mit digitaler Anzeige und Umschaltknarre, für rechtsgängigen Anzug, Anzugsgenauigkeit $\pm 3\%$

- Maßeinheit: lbf.ft
- Einfache Einstellung und Anzeige des Drehmoments durch Displayanzeige des Wertes
- Das Display bleibt mit dem eingestellten Wert eingeschaltet
- Drehmomentanzeige mit Dezimalziffer
- Automatische Ausschaltung nach 30 Sek. mit Einstellung des Drehmoments unter der Mindestschwelle
- Spannungsversorgung mit 1 Batterie 3 V (inklusive)

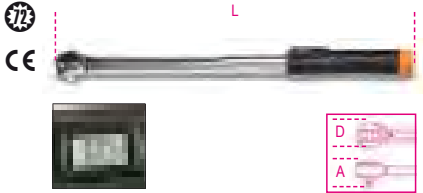

UNI EN ISO 6789

lbf.ft	■	D	A	L	g	Accuracy
7÷45	3/8	mm 30	mm 33	mm 335	655	0,1

665LB/6 € 279,00 1 006650106

lbf.ft	■	D	A	L	g	Accuracy
15÷75	3/8	mm 30	mm 33	mm 375	725	0,1

665LB/10 € 281,00 1 006650110

lbf.ft	■	D	A	L	g	Accuracy
15÷75	1/2	mm 30	mm 37	mm 375	725	0,1

665LB/10X € 287,00 1 006650111

lbf.ft	■	D	A	L	g	Accuracy
30÷150	1/2	mm 40	mm 43	mm 470	995	0,5

665LB/20 € 306,00 1 006650120

lbf.ft	■	D	A	L	g	Accuracy
45÷240	1/2	mm 40	mm 43	mm 590	1260	0,5

665LB/30 € 347,00 1 006650130

665SW

Kalibriergerät

- Das Gerät ermöglicht die Kalibrierung der Schlüssel Serie 665 mit Zuhilfenahme der Drehmomentmessgeräte 680 und 682, ohne den Schlüssel demontieren zu müssen.
- Die Kalibrierung erfolgt an mehreren Punkten, um das nicht lineare Verhalten der Feder auszugleichen.
- Ausgestattet mit Micro-USB-Anschluss für eventuelle Firmware-Updates.



665SW € 28,00 1 006650100

666-667 ZERO-RESET

DER NEUE DREHMOMENTSCHLÜSSEL, DER KEINER RÜCKSTELLUNG BEDARF

Auch wenn der Schlüssel nicht rückgesetzt wird, sind die von der Bezugsnorm geforderte Zyklenzahl, Lebensdauer und Anzugsgenauigkeit gewährleistet. Um diese Parameter zu untermauern, hat die Abteilung für Forschung und Entwicklung von Beta Utensili zahlreiche und umfangreiche Dauertests in betriebsinternen Labors und bei Hunderten von Endverbrauchern durchgeführt. Dieses Resultat wurde erreicht durch:

- die Verwendung der besten derzeit verfügbaren Materialien
- spezielle Wärmebehandlungen an den internen Komponenten

100% MADE IN ITALY

Der Drehmomentschlüssel Zero Reset wurde betriebsintern entworfen und entwickelt und wird in den Werken Beta Utensili in Italien unter Verwendung von Komponenten zu 100 % Made in Italy hergestellt.

Die neuen Schlüsselkomponenten ermöglichen es, den Schlüssel am Ende des Gebrauchs nicht mehr auf das Mindestmaß rücksetzen zu müssen.

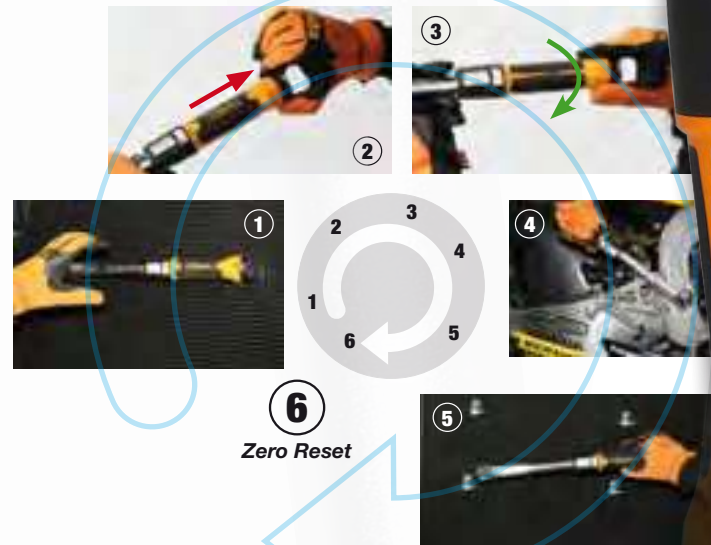

666

Drehmomentschlüssel mit Signalgebung
ZERO-RESET
mit Umschaltknarre
für rechtsgängigen Anzug
Anzugsgenauigkeit: ± 3%

• Bedarf keiner Rückstellung



UNI EN ISO 6789

Nm	5÷25	1/4	D mm	26	A mm	25	L mm	273	g	395	0,05
----	------	-----	------	----	------	----	------	-----	---	-----	------

666/2	307,00	1	006660702
-------	--------	---	-----------

Nm	5÷25	3/8	D mm	26	A mm	29	L mm	273	g	405	0,05
----	------	-----	------	----	------	----	------	-----	---	-----	------

666/2X	307,00	1	006660703
--------	--------	---	-----------

Nm	10÷50	3/8	D mm	30	A mm	33	L mm	342	g	680	0,25
----	-------	-----	------	----	------	----	------	-----	---	-----	------

666/5	279,00	1	006660705
-------	--------	---	-----------

Nm	20÷100	3/8	D mm	30	A mm	33	L mm	385	g	760	0,25
----	--------	-----	------	----	------	----	------	-----	---	-----	------

666/10	281,00	1	006660710
--------	--------	---	-----------

Nm	20÷100	1/2	D mm	30	A mm	37	L mm	385	g	770	0,25
----	--------	-----	------	----	------	----	------	-----	---	-----	------

666/10X	287,00	1	006660711
---------	--------	---	-----------

Nm	40÷200	1/2	D mm	42	A mm	43	L mm	471	g	1020	0,5
----	--------	-----	------	----	------	----	------	-----	---	------	-----

666/20	306,00	1	006660720
--------	--------	---	-----------

Nm	60÷300	1/2	D mm	42	A mm	43	L mm	600	g	1270	1,0
----	--------	-----	------	----	------	----	------	-----	---	------	-----

666/30	347,00	1	006660730
--------	--------	---	-----------

666 LBF.FT

Drehmomentschlüssel mit Signalgebung
ZERO-RESET
mit Umschaltknarre
für rechtsgängigen Anzug
Anzugsgenauigkeit: ± 3%

• Bedarf keiner Rückstellung
• Skala in Pound-Force-Foot

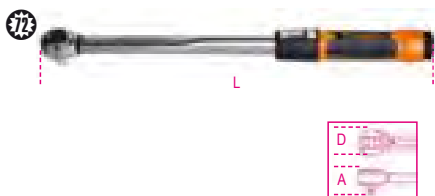

UNI EN ISO 6789

lbf.ft	4÷18	1/4	D mm	26	A mm	25	L mm	273	g	395	0,05
--------	------	-----	------	----	------	----	------	-----	---	-----	------

666 LBF.FT/2	290,00	1	006660762
--------------	--------	---	-----------

lbf.ft	4÷18	3/8	D mm	26	A mm	29	L mm	273	g	405	0,05
--------	------	-----	------	----	------	----	------	-----	---	-----	------

666 LBF.FT/2X	290,00	1	006660763
---------------	--------	---	-----------

lbf.ft	7÷37	3/8	D mm	30	A mm	33	L mm	342	g	680	0,25
--------	------	-----	------	----	------	----	------	-----	---	-----	------

666 LBF.FT/5	264,00	1	006660765
--------------	--------	---	-----------

lbf.ft	15÷75	3/8	D mm	30	A mm	33	L mm	385	g	760	0,25
--------	-------	-----	------	----	------	----	------	-----	---	-----	------

666 LBF.FT/10	266,00	1	006660780
---------------	--------	---	-----------

lbf.ft	15÷75	1/2	D mm	30	A mm	37	L mm	385	g	770	0,25
--------	-------	-----	------	----	------	----	------	-----	---	-----	------

666 LBF.FT/10X	271,00	1	006660781
----------------	--------	---	-----------

lbf.ft	30÷150	1/2	D mm	42	A mm	43	L mm	471	g	1020	0,5
--------	--------	-----	------	----	------	----	------	-----	---	------	-----

666 LBF.FT/20	289,00	1	006660782
---------------	--------	---	-----------

lbf.ft	50÷230	1/2	D mm	42	A mm	43	L mm	600	g	1270	1,0
--------	--------	-----	------	----	------	----	------	-----	---	------	-----

666 LBF.FT/30	328,00	1	006660783
---------------	--------	---	-----------

667

Drehmomentschlüssel mit Signalgebung
ZERO-RESET
mit Einfachknarre
für links- und rechtsgängigen Anzug
Anzugsgenauigkeit: ± 3%

• Bedarf keiner Rückstellung

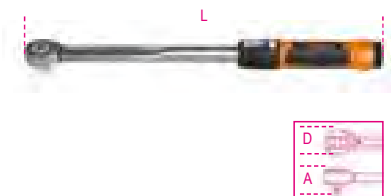

UNI EN ISO 6789

Nm	40÷200	1/2	D mm	42	A mm	42	L mm	471	g	1035	0,5
----	--------	-----	------	----	------	----	------	-----	---	------	-----

667/20	301,00	1	006670720
--------	--------	---	-----------

Nm	60÷300	1/2	D mm	42	A mm	42	L mm	600	g	1285	1,0
----	--------	-----	------	----	------	----	------	-----	---	------	-----

667/30	336,00	1	006670730
--------	--------	---	-----------

Nm	80÷400	3/4	D mm	59	A mm	53	L mm	710	g	2220	1,0
----	--------	-----	------	----	------	----	------	-----	---	------	-----

667/40	806,00	1	006670740
--------	--------	---	-----------

Für die Ersatzdrehvorrichtungen
der Knarren,
s. Details nach Artikel 929/C8

668N

Drehmomentschlüssel mit Signalgebung
für links- und rechtsgängigen Anzug
Genauigkeit: ± 3%

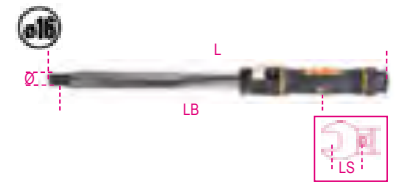

UNI EN ISO 6789

Nm	5÷25	Kgfm	0,5÷2,5	lbf.ft	4÷18	Ø mm	16	L mm	220	LB mm	148	LS mm	32	g	300	0,2
----	------	------	---------	--------	------	------	----	------	-----	-------	-----	-------	----	---	-----	-----

668N/2	281,00	1	006680002
--------	--------	---	-----------

Nm	10÷50	Kgfm	1÷5	lbf.ft	7÷37	Ø mm	16	L mm	307	LB mm	229	LS mm	32	g	590	0,5
----	-------	------	-----	--------	------	------	----	------	-----	-------	-----	-------	----	---	-----	-----

668N/5	275,00	1	006680005
--------	--------	---	-----------

Nm	20÷100	Kgfm	2÷10	lbf.ft	15÷75	Ø mm	16	L mm	376	LB mm	269	LS mm	32	g	670	1,0
----	--------	------	------	--------	-------	------	----	------	-----	-------	-----	-------	----	---	-----	-----

668N/10	281,00	1	006680010
---------	--------	---	-----------

Nm	40÷200	Kgfm	4÷20	lbf.ft	30÷150	Ø mm	16	L mm	450	LB mm	352,6	LS mm	32	g	795	2,0
----	--------	------	------	--------	--------	------	----	------	-----	-------	-------	-------	----	---	-----	-----

668N/20	306,00	1	006680020
---------	--------	---	-----------

Nm	60÷300	Kgfm	6÷30	lbf.ft	50÷220	Ø mm	16	L mm	588	LB mm	475,9	LS mm	32	g	1230	2,0
----	--------	------	------	--------	--------	------	----	------	-----	-------	-------	-------	----	---	------	-----

668N/30	347,00	1	006680030
---------	--------	---	-----------



668RG

Drehmomentschlüssel mit Signalgebung, ohne Meßteilung, für links- und rechtsgängigen Anzug, Genauigkeit: 4 % (zur Verwendung mit Art. 680 - 682)



UNI EN ISO 6789

Nm	Kgfm	lbf.ft	Ø mm	L mm	g
8÷60	0,8÷6	6÷44	16	288	550

668RG/6	€ 227,00			1	006680206
----------------	-----------------	--	--	---	-----------

Nm	Kgfm	lbf.ft	Ø mm	L mm	g
20÷100	2÷10	15÷80	16	315	600

668RG/10	€ 233,50			1	006680210
-----------------	-----------------	--	--	---	-----------

Nm	Kgfm	lbf.ft	Ø mm	L mm	g
40÷200	4÷20	30÷150	16	405	780

668RG/20	€ 248,50			1	006680220
-----------------	-----------------	--	--	---	-----------

Nm	Kgfm	lbf.ft	Ø mm	L mm	g
60÷300	6÷30	50÷220	16	645	1130

668RG/30	€ 277,00			1	006680230
-----------------	-----------------	--	--	---	-----------

668RGC

Drehmomentschlüssel mit Signalgebung, ohne Meßteilung, mit Umschaltknarre, geeignet für rechtsgängigen Anzug, Genauigkeit: ± 4 % (zur Verwendung mit Art. 680 - 682)

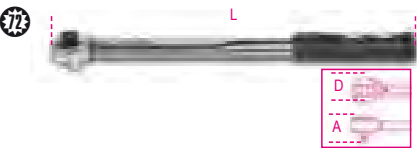

UNI EN ISO 6789

Nm	Kgfm	lbf.in	■ mm	D mm	A mm	L mm	g
12÷60	1,2÷6	5÷45	3/8	30	33	295	600

668RGC/6	€ 207,00			1	006680406
-----------------	-----------------	--	--	---	-----------

Nm	Kgfm	lbf.in	■ mm	D mm	A mm	L mm	g
20÷100	2÷10	15÷75	3/8	30	33	335	700

668RGC/10	€ 216,00			1	006680410
------------------	-----------------	--	--	---	-----------

Nm	Kgfm	lbf.in	■ mm	D mm	A mm	L mm	g
20÷100	2÷10	15÷75	1/2	40	43	342	700

668RGC/10X	€ 216,00			1	006680411
-------------------	-----------------	--	--	---	-----------

Nm	Kgfm	lbf.in	■ mm	D mm	A mm	L mm	g
40÷200	4÷20	30÷150	1/2	40	43	425	1000

668RGC/20	€ 220,50			1	006680420
------------------	-----------------	--	--	---	-----------

669N

Drehmomentschlüssel mit Signalgebung, rechteckiger Innenanschluss, für links- und rechtsgängigen Anzug, Genauigkeit: ± 3%



UNI EN ISO 6789

Nm	Kgfm	lbf.ft	□ mm	L mm	LB mm	LS mm	g
5÷25	0,5÷2,5	4÷18	9x12	215	140	28,8	300

669N/2	€ 401,00			1	006690202
---------------	-----------------	--	--	---	-----------

Nm	Kgfm	lbf.ft	□ mm	L mm	LB mm	LS mm	g
10÷50	1÷5	7÷37	9x12	307	226,8	28,8	590

669N/5	€ 308,00			1	006690205
---------------	-----------------	--	--	---	-----------

Nm	Kgfm	lbf.ft	□ mm	L mm	LB mm	LS mm	g
20÷100	2÷10	15÷75	9x12	376	266,8	28,8	670

669N/10	€ 332,00			1	006690210
----------------	-----------------	--	--	---	-----------

Nm	Kgfm	lbf.ft	□ mm	L mm	LB mm	LS mm	g
40÷200	4÷20	30÷150	9x12	450	345,6	28,8	795

669N/20	€ 398,00			1	006690220
----------------	-----------------	--	--	---	-----------

Nm	Kgfm	lbf.ft	□ mm	L mm	LB mm	LS mm	g
40÷200	4÷20	30÷150	14x18	450	351	39,8	795

669N/20X	€ 420,00			1	006690221
-----------------	-----------------	--	--	---	-----------

Nm	Kgfm	lbf.ft	□ mm	L mm	LB mm	LS mm	g
60÷300	6÷30	50÷220	14x18	588	468,5	39,8	1230

669N/30	€ 443,00			1	006690230
----------------	-----------------	--	--	---	-----------

Nm	Kgfm	lbf.ft	□ mm	L mm	LB mm	LS mm	g
80÷400	8÷40	60÷295	14x18	664	563	39,8	2100

669N/40	€ 510,00			1	006690240
----------------	-----------------	--	--	---	-----------



671B/C5

Drehmomentschlüssel Art. 604B/5 mit Zubehör



671B/C5	€ 1.122,00			1	006710001
----------------	-------------------	--	--	---	-----------

604B/5	1÷5 Nm
611	1/4
641	5-6-7-8 mm
900	4-5-5,5-6-7-8-9-10 mm

270x120x45 mm - 1,3 kg

671B/C10

Drehmomentschlüssel Art. 604B/10 mit Zubehör



671B/C10	€ 1.122,00			1	006710002
-----------------	-------------------	--	--	---	-----------

604B/10	2÷10 Nm
611	1/4
641	6-7-8-10 mm
900	4-5-5,5-6-7-8-9-10 mm

270x120x45 mm - 1,4 kg

671N/C10

Drehmomentschlüssel Art. 668N/10 mit Zubehör



671N/C10	€ 1.265,00			1	006710110
-----------------	-------------------	--	--	---	-----------

668N/10	100 Nm
612	■ 3/8
617	■ 3/8
642	10-13-14-17-19 mm
652	10-13-14-17-19 mm
910A	□ 3/8 8-10-11-13-14-17-19 mm
910/21	125 mm
910/22	250 mm

400x180x45 mm - 4,3 kg

671N/C20

Drehmomentschlüssel Art. 668N/20 mit Zubehör



671N/C20 € 1.340,00 1 006710120

668N/20	200 Nm
614	■ 1/2
619	■ 1/2
642	10-13-14-17-19 mm
652	10-13-14-17-19 mm
○ 920A	□ 1/2 10-11-13-14-17-19-22 mm
920/20	75 mm
920/21	125 mm
920/22	255 mm

510x180x45 mm - 5,5 kg

671N/C30

Drehmomentschlüssel Art. 668N/30 mit Zubehör



671N/C30 € 1.270,00 1 006710130

668N/30	300 Nm
614	■ 1/2
619	■ 1/2
642	13-14-17-19 mm
652	13-14-17-19 mm
○ 920A	□ 1/2 13-14-17-19-22-24-27 mm
920/20	75 mm
920/21	125 mm
920/22	255 mm

620x180x45 mm - 5,8 kg



674/C

Drehmomentschlüssel mit Signalgebung, runder Anschluss, Ø 22 mm, für links- und rechtsgängigen Anzug, Genauigkeit: ± 4% im Kasten



UNI EN ISO 6789

Nm	Kgfm	lbf.ft	Ø mm	L mm	LB mm	LS mm	kg	U
100÷500	10÷50	80÷400	22	786	725	56	3,4	1,25

674/C50 € 929,00 1 006740005

Nm	Kgfm	lbf.ft	Ø mm	L mm	LB mm	LS mm	kg	U
160÷800	16÷80	120÷600	22	997	915	56	4,5	2,0

674/C80 € 985,00 1 006740008

Nm	Kgfm	lbf.ft	Ø mm	L mm	LB mm	LS mm	kg	U
200÷1000	20÷100	150÷750	22	997	915	56	4,5	2,5

674/C100 € 998,00 1 006740010

677

Drehmomentschlüssel mit automatischer Langwegauslösung, mit Einfachnarre, für links- und rechtsgängigen Anzug, Anzugsgenauigkeit: ±4%

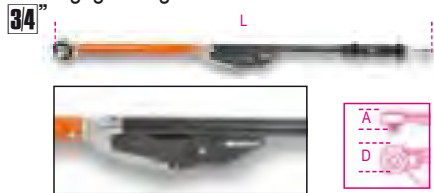

UNI EN ISO 6789

Nm	Kgfm	lbf.ft	D mm	A mm	L mm	kg	U
120÷600	12÷60	100÷450	69	55	1059	6,0	10

677/600 € 1.044,00 1 006770006

Nm	Kgfm	lbf.ft	D mm	A mm	L mm	kg	U
200÷800	20÷80	150÷600	69	55	1319	6,7	10

677/800 € 1.092,00 1 006770008

Nm	Kgfm	lbf.ft	D mm	A mm	L mm	kg	U
300÷1000	30÷100	200÷750	69	55	1554	7,4	20

677/1000 € 1.171,00 1 006770010

677/C

Drehmomentschlüssel mit Einfachnarre, für links- und rechtsgängigen Anzug, Genauigkeit: ± 4% mit Kasten



677/1500



UNI EN ISO 6789

Nm	Kgfm	lbf.ft	D mm	A mm	L mm	kg	U
120÷600	12÷60	100÷450	69	55	1059	6,0	10

677/C600 € 1.230,00 1 006770607

Nm	Kgfm	lbf.ft	D mm	A mm	L mm	kg	U
200÷800	20÷80	150÷600	69	55	1319	6,7	10

677/C800 € 1.275,00 1 006770612

Nm	Kgfm	lbf.ft	D mm	A mm	L mm	kg	U
300÷1000	30÷100	200÷750	69	55	1554	7,4	20

677/C1000 € 1.355,00 1 006770616

Nm	Kgfm	lbf.ft	D mm	A mm	L mm	kg	U
700÷1500	70÷150	500÷1000	69	55	1869	9,6	25

677/C1500 € 1.735,00 1 006770621

677/CP2000

Drehmomentschlüssel mit automatischer Langwegauslösung für links- und rechtsgängigen Anzug, Genauigkeit: ± 4% im Kasten



UNI EN ISO 6789

Nm	Kgfm	lbf.ft	D mm	A mm	L mm	kg	U
900÷2000	90÷200	700÷1500	69	63	1940	12,75	50

677/CP2000 € 3.180,00 1 006770721



Beta

678/C

Drehmomentschlüssel mit Signalgebung, mit Einfachnarre, für links- und rechtsgängigen Anzug
Genauigkeit: $\pm 4\%$ mit Kasten

• Art. 678/C100 und Art. 678/C150 mit Verlängerung geliefert.

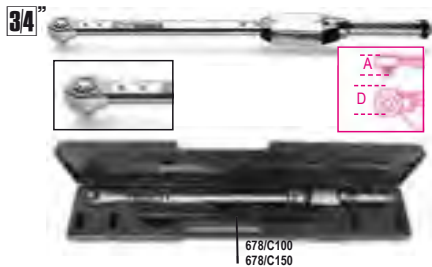

UNI EN ISO 6789

Nm	Kgfm	lbf.ft	D	A	L	W
130÷650	13÷65	100÷480	mm	mm	mm	kg
			63	55	885	3,9

678/C65 € 1.920,00 1 006780607

Nm	Kgfm	lbf.ft	D	A	L	W
300÷1000	30÷100	220÷750	mm	mm	mm	kg
			75	60	1250	6,0

678/C100 € 2.550,00 1 006780611

Nm	Kgfm	lbf.ft	D	A	L	W
500÷1500	50÷150	370÷1100	mm	mm	mm	kg
			75	60	1570	8,5

678/C150 € 2.780,00 1 006780615

677/CV - 678/CV

Kästen für Drehmomentschlüssel Art. 677 und 678



677/CVN1 € 189,50 1 006770455

677/C600-677/C800-677/C1000

677/CVN2 € 248,50 1 006770460

677/C1500-677/CP2000

678/CV1 € 178,50 1 006780455

678/C65

678/CV2 € 201,00 1 006780500

678/C100

678/CV3 € 332,00 1 006780415

677/C100-677/C150-678/C150

680

Digitaler Drehmomentmesser
Dynatester 680
zur Prüfung der Eichung
rechts- und linksgängig

- Ablesegenauigkeit: $\pm 1\%$ des abgelesenen Werts
- 4-Digit-LCD-Farbdisplay
- 3 Maßeinheiten: Nm - lbf.ft. - lbf.in



	Nm	kg	€	W	W
680/3	0,1÷3	1,4	3.260,00	1	006800000
680/30	1,5÷30	1,4	3.220,00	1	006800003
680/350	10÷350	2,6	3.230,00	1	006800035
680/2100	200÷2100	3,5	4.800,00	1	006800210

682

Elektronisches Drehmomentmessgerät mit Digitalanzeige mit Messwertgeber
Dynatester 682, rechts- und linksgängig
Hohe Präzision der elektronischen Messung
Ausgestattet mit serieller Schnittstelle RS 232



TECHNISCHE EIGENSCHAFTEN
Genauigkeit $\pm 1\%$ des abgelesenen Werts
Wählbare Messeinheiten
Nm-dNm-cNm-Lbf.ft-Lbf.in-Ozf.in-Kgf.m-Kgf.cm-gf.cm
Netzanschluss 90 - 264V AC 50/60 Hz
Abmessungen 235x185x185 mm
Toleranzprüfung nach Norm ISO 6789
Angabe des spezifischen Zulässigkeitsintervalls für jeden geprüften Drehmomentschlüssel
Display
In 11 Sprachen wählbares Menü
Beigefügte Unterlagen
Kalibrationsnachweis, mit UKAS-Auffindbarkeit

	Nm	kg	€	W	W
682/60	1,2÷60	5,9	6.670,00	1	006820006
682/400	8÷400	6,1	6.770,00	1	006820040
682/1500	30÷1500	6,4	6.980,00	1	006820150

KRAFTSTECKSCHLÜSSEL



Die Kraftsteckschlüssel sind überdimensioniert im Vergleich zu den manuellen Steckschlüsselmodellen, um die von den Impuls-Schlagschrauben und den Drehmomentvervielfältigern erzeugten hohen Drehmomente zu absorbieren. Das sechskantige Profil garantiert eine höhere Lebensdauer angesichts der intensiven Verwendung, der die Schlüssel ausgesetzt sind.

Zu ihrer Nutzung ist der Gebrauch von Stiften und Dichtringen absolut notwendig, um das Abtrennen vom Manöverkopf zu verhindern.

Das neue Zwölfkant-Profil ermöglicht ein sofortiges Ankuppeln an die Mutter.

Zu den klassischen Standardmodellen, der langen Serie und der langen schlanken Serie, gesellen sich das neue XZN®-Profil und ein erweitertes Angebot an Kraftsteckschlüsselzubehör.



710

Kraftsteckschlüssel,
für Schlagschrauber, Standardausführung



UNI/ISO 2725 DIN 3129

Ø mm	Ø mm	L mm	Ø1 mm	€	U	Icon
7	12,5	28	19	7,30	3	007100007
8	13,8	28	19	7,30	3	007100008
9	15,0	28	19	7,30	3	007100009
10	16,3	28	19	7,30	3	007100010
11	17,5	30	19	7,30	3	007100011
12	19,0	30	19	7,30	3	007100012
13	20,0	30	22	7,70	3	007100013
14	21,3	30	22	7,70	3	007100014
16	23,8	30	22	7,70	3	007100016
17	25,0	30	22	7,70	3	007100017
18	26,3	30	22	8,00	3	007100018
19	27,5	30	22	8,00	3	007100019
21	30,0	32	22	8,90	3	007100021
22	32,0	32	22	9,80	3	007100022

710/C10

Kraftsteckschlüsselsatz, 10teilig



710/C10 € 96,00 1 007100910

7-8-10-11-12-13
14-17-19-22 mm

130x55x40 mm - 800 g

710/16

Verbindungsstück, Innenvierkant 3/8",
Außenvierkant 1/2"



L mm Ø mm 3/8 1/2 € 17,20 3 007100810

710/20

Verlängerung,
Innen- und Außenvierkant 3/8"



L mm Ø mm € 17,50 2 007100821

710/21

Verlängerung,
Innen- und Außenvierkant 3/8"



L mm Ø mm € 19,20 2 007100823

710/22

Verlängerung für Maschineneinsatz,
Innen- und Außenvierkant 3/8"



L mm Ø mm € 22,40 2 007100825

710/25

Kardangeln,
Innen- und Außenvierkant 3/8"



L mm Ø mm € 35,50 2 007100830

710/OR... - 710/SP...

Gummiringe, Sicherungsstife
und Zubehör für Kraftsteckschlüssel



	710 mm	710/16 L mm	€	U	Icon
710/OR1	7÷12		0,70	10	007100921
710/OR2	13÷22	32	0,70	10	007100922
710/SP1	7÷12		1,10	10	007100911
710/SP2	13÷22	32	1,10	10	007100912

720

Kraftsteckschlüssel,
für Schlagschrauber, Standardausführung



UNI/ISO 2725 DIN 3129

Ø mm	Ø mm	L mm	Ø1 mm	€	U	Icon
8	15,0	38	25	8,80	5	007200008
9	16,0	38	25	8,80	5	007200009
10	17,0	38	25	8,80	5	007200010
11	18,5	38	25	8,80	5	007200011
12	20,0	38	25	8,80	5	007200012
13	21,0	38	25	8,80	5	007200013
14	22,5	38	25	8,80	5	007200014
15	23,0	38	30	9,90	5	007200015
16	25,0	38	30	9,90	5	007200016
17	26,0	38	30	9,90	5	007200017
18	27,5	38	30	9,90	5	007200018
19	28,5	38	30	9,90	5	007200019
20	30	38	30	9,60	5	007200020
21	31,0	38	30	11,00	5	007200021
22	32,5	38	30	11,10	5	007200022
23	34,0	38	30	12,30	5	007200023
24	35,0	38	30	12,30	5	007200024
27	38,5	45	30	14,30	3	007200027
29	41	47	30	13,50	3	007200029
30	42,0	50	30	15,50	3	007200030
32	44,0	50	30	17,70	3	007200032
36	50,0	50	30	25,50	3	007200036

720/C6

6 Kraftsteckschlüssel



720/C6 € 90,00 1 007200910

13-14-17-19-22-24 mm

195x80x55 mm - 1100 g

720/C12

12 Kraftsteckschlüssel



720/C12 € 164,00 1 007200912

10-11-12-13-14-17
19-22-24-27-30-32 mm

195x80x55 mm - 2000 g

720/C24

Kraftsteckschlüsselsatz, 24-teilig



720/C24 € 342,00 1 007200904

- 720 10 - 12 - 13 - 14 - 15 - 16 - 17 - 18 - 19 - 21 - 22 - 24 - 27 - 30 - 32 mm
- 720L 13 - 17 - 19 - 21 - 22 - 24 mm
- 720LC 17 - 19 - 21 mm

420x185x60 mm - 6,2 kg

720MC

Kraftsteckschlüssel, Standardausführung, farbig



Ø mm	Ø mm	L mm	€	Stk	Art-Nr
10	17,0	38	10,50	3	007202010
11	18,5	38	10,50	3	007202011
12	20,0	38	10,50	3	007202012
13	21,0	38	10,50	3	007202013
14	22,5	38	10,50	3	007202014
15	23,0	38	11,90	3	007202015
16	25,0	38	11,90	3	007202016
17	26,0	38	11,90	3	007202017
18	27,5	38	11,90	3	007202018
19	28,5	38	11,90	3	007202019
21	31,0	38	13,20	2	007202021
22	32,5	38	13,20	2	007202022
24	35,0	38	14,40	2	007202024

720MC/C13

13 Kraftsteckschlüssel, farbig



720MC/C13 € 190,50 1 007202913

- 10-11-12-13-14-15
- 16-17-18-19-21-22
- 24 mm

335x145x60 mm - 2,4 kg

720B

Zwölfkant-Kraftsteckschlüssel



UNI/ISO 2725 DIN 3129

Ø mm	Ø mm	L mm	Ø1 mm	€	Stk	Art-Nr
10	17	38	25	10,20	5	007201010
11	18	38	25	10,20	5	007201011
12	19	38	25	10,20	5	007201012
13	20	38	25	10,20	5	007201013
14	22	38	25	10,20	5	007201014
15	23	38	30	11,40	5	007201015
16	24	38	30	11,40	5	007201016
17	26	38	30	11,40	5	007201017
18	27	38	30	11,40	5	007201018
19	28	38	30	11,40	5	007201019
21	30	38	30	12,60	5	007201021
22	31,8	38	30	12,70	5	007201022
23	31,8	38	30	13,90	5	007201023
24	33,8	40	30	13,90	5	007201024
27	37,8	43	30	16,10	3	007201027
30	41,8	43	30	17,70	3	007201030
32	43,8	43	30	20,20	3	007201032
36	49,8	50	30	29,00	3	007201036

720B/C12

12 Zwölfkant-Kraftsteckschlüssel



UNI/ISO 2725 DIN 3129

720B/C12 € 220,50 1 007201912
10-11-12-13-14-17
19-22-24-27-30-32 mm

195x80x55 mm - 2000 g

720AS

Kraftsteckschlüssel, für Schlagschrauber, Standardausführung



Ø mm	Ø mm	L mm	Ø1 mm	€	Stk	Art-Nr
3/8	17,0	38	25	12,60	2	007200210
7/16	18,2	38	25	12,60	2	007200211
1/2	20,7	38	25	12,60	2	007200213
9/16	22,0	38	25	12,60	2	007200214
5/8	24,5	38	30	13,50	2	007200216
11/16	25,7	38	30	13,50	2	007200217
3/4	28,2	38	30	13,50	2	007200219
13/16	30,7	38	30	14,30	2	007200221
7/8	32,0	38	30	14,30	2	007200222
15/16	34,5	38	30	15,20	2	007200224
1	35,7	38	30	16,40	2	007200225
1.1/16	38,2	40	30	18,00	1	007200227
1.1/8	40,7	42	30	20,00	1	007200229
1.1/4	44,5	42	30	22,40	1	007200232

720S

Kraftsteckschlüssel, kompakte Ausführung



Ø mm	Ø mm	L mm	Ø1 mm	€	Stk	Art-Nr
13	20,0	28,0	23,8	6,40	3	007200113
15	23,0	28,0	23,8	6,40	3	007200115
17	25,8	28,0	25,8	7,00	3	007200117
19	27,8	28,0	27,8	7,60	3	007200119
22	31,8	28,0	30,0	8,30	3	007200122
24	33,8	28,0	30,0	8,90	3	007200124



720S/SB6 € 47,50 1 007200906
13-15-17-19-22-24 mm

720L

Kraftsteckschlüssel, für Schlagschrauber, lange Ausführung



UNI/ISO 2725

Ø mm	Ø mm	L mm	Ø1 mm	€	Stk	Art-Nr
10	17,0	80	25	15,10	2	007200310
11	18,5	80	25	15,10	2	007200311
12	20,0	80	25	15,10	2	007200312
13	21,0	80	25	15,10	2	007200313
14	22,5	80	25	15,10	2	007200314
15	23,0	80	30	17,30	2	007200315
16	25,0	80	30	17,30	2	007200316
17	26,0	80	30	17,30	2	007200317
18	27,5	80	30	18,50	2	007200318
19	28,5	80	30	18,50	2	007200319
21	31,0	80	30	19,30	2	007200321
22	32,5	80	30	19,30	2	007200322
24	35,0	80	30	20,50	2	007200324
27	38,5	80	30	25,00	2	007200327
30	42,0	80	30	31,00	2	007200330
32	44,0	80	30	31,00	2	007200332
36	50,0	80	30	40,00	2	007200336

720L/S3

Kraftsteckschlüsselsatz, 3teilig Art.720L



720L/S3 € 55,00 1 007200355
17-19-21 mm

720LS

Kraftsteckschlüssel
lange, schmale Ausführung



mm	Ø mm	L mm	Ø1 mm	€	U	PC
10	15,5	78	24	16,40	2	007200360
11	16,7	78	24	16,40	2	007200361
12	18,0	78	24	16,40	2	007200362
13	19,2	78	24	16,40	2	007200363
14	20,5	78	24	16,40	2	007200364
15	21,7	78	24	16,80	2	007200365
16	23,0	78	24	16,80	2	007200366
17	24,2	78	29	18,80	2	007200367
18	25,5	78	29	20,20	2	007200368
19	26,7	78	29	20,20	2	007200369
21	29,2	78	29	21,30	2	007200371
22	30,5	78	29	21,30	2	007200372
24	33,0	78	29	21,70	2	007200374
27	36,7	78	29	26,50	2	007200377
30	40,5	78	29	33,50	2	007200380
32	43,0	78	29	34,50	2	007200382
36	48,0	78	29	52,00	2	007200386

720LC

Kraftsteckschlüssel für Radschrauben,
mit farbigen Polymereinsätzen



mm	Ø mm	€	U	PC
17	26,5	11,00	2	007200637
19	28,5	11,00	2	007200639
21	30,3	11,40	2	007200641
22	32,4	11,80	2	007200642
24	34,6	12,80	2	007200644



720LC/C3	€	U	PC
17-19-21 mm	37,50	1	007200653

148x132x44 mm - 860 g



720LC/S5	€	U	PC
17-19-21-22-24 mm	66,00	1	007200645

12"



720LC/PM5	€	U	PC
17-19-21-22-24 mm	131,00	1	007200646

PM 1/2-Q5

Steckschlüsselschiene, magnetisch



PM 1/2-Q5	€	U	PC
	53,50	1	088880233

720IC

Farbige Ersatz-Polymereinsätze für
Kraftsteckschlüssel Art. 720LC-720LCL



720IC	mm	€	U	PC
17	17	5,10	1	007200687
19	19	5,10	1	007200689
21	21	5,10	1	007200691
22	22	5,10	1	007200692
24	24	5,10	1	007200694



720LCL

Kraftsteckschlüssel mit farbigen
Polymereinsätzen
für Radmuttern,
lange Ausführung



mm	Ø mm	€	U	PC
17	26,5	20,70	1	007200737
19	28,5	20,70	1	007200739
21	30,3	20,70	1	007200741



720LCL/C3	€	U	PC
17-19-21 mm	78,50	1	007200753

210x50x150 mm - 1,65 kg

720MRC

Kraftsteckschlüssel
mit Polymereinsatz für Radschraube mit
Mercedes Profil



mm	Ø mm	L mm	€	U	PC
17	27	85	17,70	1	007200631

720FRD

Kraftsteckschlüssel für Ford-Radmuttern
mit beschädigter Aluminiumabdeckung

Unerlässlich bei durch Schlagschrauber beschädigten
Mutterspitzen



mm	L mm	€	U	PC
18,5+19,5	63	14,70	1	007200634

720RNG

Kraftsteckschlüssel für Jeep Renegade
Radmuttern mit beschädigter
Aluminiumabdeckung

Unerlässlich bei durch Schlagschrauber beschädigten
Mutterspitzen



mm	L mm	€	U	PC
16,5+17,5	63	22,70	1	007200634

720TC

Maschinen-torsionsstäbe, farbig,
für KFZ-Radmuttern,
mit 1/2" Innen- und Außenvierkantanschluss



Nm	L mm	€	U	PC
90	200	21,90	1	007200769
100	200	21,90	1	007200770
110	200	21,90	1	007200771
120	200	21,90	1	007200772
135	200	21,90	1	007200773

12"



720TC/SS € 109,00 1 007200779
 90-100-110-120-135 Nm
 ≡ 260x50x175 mm - 1,35 kg

720FTX

Kraftsteckschlüssel für Torx®-Schrauben



12"



	Ø mm	L mm	Ø1 mm	€		
E10	14,0	38	25	14,30	2	007200410
E12	15,9	38	25	14,30	2	007200412
E14	17,7	38	25	14,30	2	007200414
E16	20,0	38	25	14,30	2	007200416
E18	22,0	38	25	14,30	2	007200418
E20	25,0	40	25	15,10	2	007200420
E24	30,0	40	30	15,10	2	007200424



12"



720FTX/SB6 € 94,00 1 007200450
 E10-E12-E14
 E16-E18-E20

720TX

Steckschlüssel für Maschineneinsatz, für Torx®-Schrauben



12"



	Ø mm	L mm	L1 mm	€		
T30	25	78	54	12,40	3	007200460
T40	25	78	54	12,40	3	007200470
T45	25	78	54	12,70	3	007200472
T50	25	78	54	12,70	3	007200474
T55	25	78	54	14,40	3	007200476
T60	25	78	54	16,50	3	007200478

720TX/C6

6 Steckschlüssel für Maschineneinsatz, für Torx®-Schrauben



12"



720TX/C6 € 105,00 1 007200483
 T30-T40-T45
 T50-T55-T60

≡ 275x120x65 mm - 5700 g

720ME

Sechskant-Steckschlüssel für Maschineneinsatz



12"



mm	Ø mm	L mm	L1 mm	€		
5	25	78	54	12,00	3	007200505
6	25	78	54	12,00	3	007200506
8	25	78	54	12,00	3	007200508
10	25	78	54	12,00	3	007200510
12	25	78	54	12,00	3	007200512
14	25	78	54	13,30	3	007200514
17	25	78	54	13,30	3	007200517
19	25	78	54	13,30	3	007200519

720ME/C8

8 Sechskant-Steckschlüssel für Maschineneinsatz



12"



720ME/C8 € 124,00 1 007200525
 5-6-8-10-12
 14-17-19 mm

≡ 270x120x45 mm - 1710 g

9899 720ME/C8 € 15,60 1 098990130
 Thermoformateinsatz, leer

720XZN

Kraftsteckschlüssel für XZN®-Schrauben



12"



Ø	mm	L mm	L1 mm	€		
M4	25	77	53	15,50	3	007201504
M5	25	77	53	15,50	3	007201505
M6	25	77	53	15,50	3	007201506
M8	25	77	53	15,50	3	007201508
M10	25	77	53	15,90	3	007201510
M12	25	77	53	16,30	3	007201512
M14	25	77	53	16,30	3	007201514
M16	25	77	53	16,60	3	007201516
M18	25	77	53	17,50	3	007201518

720XZN/C6

6 Kraftsteckschlüssel für XZN®-Schrauben



12"



720XZN/C6 € 148,50 1 007201530
 M8-M10-M12-M14
 M16-M18

≡ 275x120x65 mm - 5700 g

720/SN

Kraftsteckschlüssel, Ausführung mit Gelenk



12"



mm	Ø mm	L mm	Ø1 mm	€		
17	25,7	69,6	30	84,00	2	007200087
19	28,2	73,6	30	84,00	2	007200089
24	34,5	75,6	30	94,00	2	007200094

720/15

Reduzierstück, Innenvierkant 1/2", Außenvierkant 3/8"

12"



L mm	Ø mm	□	■	€		
37,5	25	1/2	3/8	9,90	3	007200810



Die Torsionslast muss unbedingt angemessen und stufenweise aufgebracht werden, um Bruch oder zufällige Beschädigung zu vermeiden.

720/16

Verbindungsstück, Innenvierkant 1/2", Außenvierkant 3/4"

12"



L mm	Ø mm	□	■	€		
44	30	1/2	3/4	17,20	3	007200814

720/20

Verlängerung,
Innen- und Außenvierkant 1/2"



L	Ø	€	U	IT
mm	mm			
75	25	17,60	3	007200818

720/21

Verlängerung,
Innen- und Außenvierkant 1/2"



L	Ø	€	U	IT
mm	mm			
125	25	19,20	3	007200822

720/22

Verlängerung für Maschineneinsatz,
Innen- und Außenvierkant 1/2"



L	Ø	€	U	IT
mm	mm			
250	25	19,60	3	007200824

720/25

Kardangeln,
Innen- und Außenvierkant 1/2"



L	Ø	€	U	IT
mm	mm			
64	28	32,50	2	007200831

720/OR... - 720/SP...

Gummiringe, Sicherungsstifte
und Zubehör für Kraftsteckschlüssel



	720	720TX	€	U	IT
	mm	mm			
720/OR1	10÷14	T30÷T60	1,60	10	007200923
720/OR2	15÷36		1,60	10	007200924
720/SP1	10÷14	T30÷T60	1,83	10	007200913
720/SP2	15÷36		1,83	10	007200914

727PI/16 1/2

Einsatzhalter für Maschineneinsatz
für Art. 727/ES16, Art. 727/ES16TX und Art.
727/ES16XZN

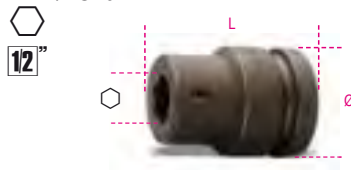

Ø	L	Ø	€	U	IT
mm	mm	mm			
28	42	16	30,50	2	007270015

727PI/16

Einsatzhalter für Maschineneinsatz,
für Art. 727/ES16 und Art. 727/ES16TX



Ø	L	Ø	€	U	IT
mm	mm	mm			
44	52	16	44,00	2	007270016

727/ES16

Schraubeinsätze für Maschineneinsatz,
Außensechskant 16 mm



mm	Ø	L	€	U	IT
	mm	mm			
10	16	40	14,90	2	007270110
12	16	40	14,90	2	007270112
13	16	40	14,90	2	007270113
14	16	40	14,90	2	007270114
16	16	40	16,00	2	007270116
17	16	40	16,00	2	007270117
18	16	40	16,80	2	007270118
19	16	40	16,80	2	007270119
22	16	40	19,10	2	007270122

727/ES16TX

Schraubeinsätze für Maschineneinsatz,
für Torx®-Schrauben,
Außenvierkant 16 mm



Ø	mm	L	€	U	IT
	mm	mm			
T55	16	50	22,30	2	007270355
T60	16	50	22,30	2	007270360
T70	16	50	22,30	2	007270370

727/ES16XZN

Schraubeinsätze für Maschineneinsatz, für
XZN®-Schrauben, Außenvierkant 16 mm



Ø	mm	L	€	U	IT
	mm	mm			
M6	16	60	33,00	2	007270606
M8	16	60	33,00	2	007270608
M10	16	60	33,00	2	007270610
M12	16	60	33,00	2	007270612
M14	16	60	33,00	2	007270614
M16	16	60	33,00	2	007270616
M18	16	60	45,00	2	007270618

Beta

Beta

727PI/22

Einsatzhalter für Maschineneinsatz,
für Art. 727/ES22 und Art. 727/ES22TX



Ø mm	L mm	Ø mm	€	Hand	Computer
54	70	22	67,50	2	007270022

727/ES22

Schraubeinsätze für Maschineneinsatz,
Außensechskant 22 mm



mm	Ø mm	L mm	€	Hand	Computer
19	22	50	19,10	2	007270219
22	22	50	19,10	2	007270222
24	22	50	21,10	2	007270224
27	22	50	23,70	2	007270227
30	22	50	28,50	2	007270230
32	22	50	30,50	2	007270232

727/ES22TX

Schraubeinsätze für Maschineneinsatz,
für Torx®-Schrauben, Außenvierkant 22 mm



	Ø mm	L mm	€	Hand	Computer
T80	22	60	31,00	2	007270480
T90	22	60	31,00	2	007270490
T100	22	60	31,00	2	007270500

727/C16

12 Schraubeinsätze für Maschineneinsatz
und 4 Betätigungswerkzeuge



727/C16	€	Hand	Computer
	425,00	1	007270900

- 727PI/16
- 727/ES16 14-17-19 mm
- 727/ES16TX T55-T60-T70
- 727PI/22
- 727/ES22 22-24-27 mm
- 727/ES22TX T80-T90-T100
- 96BPC 3-4 mm

335x145x60 mm - 3,6 kg

727PI/32

Einsatzhalter für Maschineneinsatz,
für Art. 727/ES32

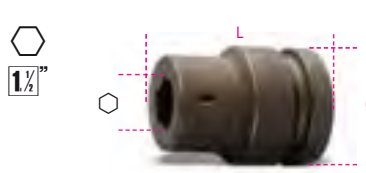

Ø mm	L mm	Ø mm	€	Hand	Computer
86	66	32	168,50	1	007270032

727/ES32

Schraubeinsatz für Maschineneinsatz,
Außensechskant 32 mm



mm	Ø mm	L mm	€	Hand	Computer
19	32	44	43,50	2	007270519
22	32	44	43,50	2	007270522
24	32	44	43,50	2	007270524
27	32	44	43,50	2	007270527
30	32	44	43,50	2	007270530
32	32	44	43,50	2	007270532
36	32	44	48,00	2	007270536

728

Kraftsteckschlüssel, für Schlagschrauber,
Standardausführung



UNI/ISO 2725 DIN 3129

mm	Ø mm	L mm	Ø1 mm	€	Hand	Computer
17	30,0	51	44	22,00	2	007280017
18	31,0	51	44	22,00	2	007280018
19	32,5	51	44	22,00	2	007280019
21	35,0	51	44	22,00	2	007280021
22	36,0	51	44	22,00	2	007280022
23	37,5	51	44	22,40	2	007280023
24	38,5	51	44	22,40	2	007280024
27	42,5	53	44	22,40	2	007280027
28	44,0	53	44	23,10	2	007280028
30	46,0	53	44	23,60	2	007280030
32	48,5	57	44	24,50	2	007280032
33	50,0	57	44	26,50	2	007280033
34	51,0	57	44	26,50	2	007280034
35	52,5	57	44	27,50	2	007280035
36	53,5	57	44	28,00	2	007280036
38	56,0	57	44	32,00	1	007280038
40	58,5	58	44	33,00	1	007280040
41	60,0	58	44	34,00	1	007280041
44	64,0	62	44	37,00	1	007280044
45	65,0	62	44	39,50	1	007280045
46	66,0	62	44	40,50	1	007280046
50	71,0	68	54	47,50	1	007280050
55	77,5	71	54	52,50	1	007280055
60	83,0	73	54	59,50	1	007280060
65	88,0	78	54	67,00	1	007280065



728/C10

Kraftsteckschlüsselsatz, 10teilig



728/C10	€	Hand	Computer
17-19-22-24-27-30-32-36-41-46 mm	294,00	1	007280910

275x120x65 mm - 5,7 kg

728B

Zwölfkant-Kraftsteckschlüssel



UNI/ISO 2725 DIN 3129

mm	Ø mm	L mm	Ø1 mm	€	Hand	Computer
17	28,5	50	38	19,20	2	007280117
19	30	52	38	19,20	2	007280119
21	32	52	38	19,20	2	007280121
22	34	52	38	19,20	2	007280122
23	35	52	38	19,60	2	007280123
24	36	52	38	19,60	2	007280124
27	40	52	40	19,60	2	007280127
29	42	52	42	20,30	2	007280129
30	44	52	44	20,70	2	007280130
32	48	52	44	21,70	2	007280132
33	50	56	44	23,20	2	007280133
34	51	56	44	23,20	2	007280134
35	52	56	44	23,90	2	007280135
36	53,5	56	44	24,60	2	007280136
38	56	56	44	27,50	1	007280138
41	60	58	44	29,50	1	007280141
46	67	63	44	35,00	1	007280146

728B/C10

10 Zwölfkant-Kraftsteckschlüssel



728B/C10	€	Hand	Computer
17-19-22-24-27-30-32-36-41-46 mm	396,00	1	007280930

275x120x65 mm - 5,7 kg

728AS

Kraftsteckschlüssel,
Standardausführung

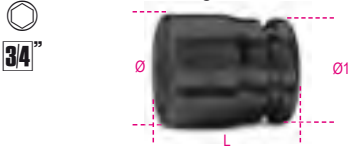

"	Ø mm	L mm	Ø1 mm	€		
3/4	32,0	51	41	22,10	1	007280219
13/16	35,0	51	41	22,60	1	007280221
7/8	36,0	51	41	22,60	1	007280222
15/16	38,5	51	41	22,60	1	007280224
1	40,0	53	41	23,10	1	007280225
1.1/16	42,5	53	44	24,20	1	007280227
1.1/8	44,0	53	44	24,60	1	007280230
1.1/4	48,5	57	44	25,00	1	007280232
1.5/16	50,0	57	44	26,50	1	007280233
1.7/16	53,5	57	44	28,00	1	007280236
1.1/2	56,0	57	44	31,50	1	007280238
1.5/8	60,0	58	44	34,00	1	007280241

728FTX

Kraftsteckschlüssel für Torx®-Schrauben



"	Ø mm	L mm	Ø1 mm	€		
E20	28,5	50	44	30,00	2	007280420
E22	30,0	50	44	30,00	2	007280422
E24	32,5	50	44	30,00	2	007280424

728ME

Sechskant-Kraftsteckschlüssel

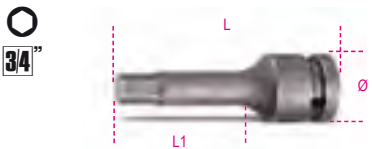

mm	Ø mm	L mm	L1 mm	€		
12	44	100	67	22,40	3	007280712
14	44	100	67	25,00	3	007280714
17	44	100	67	25,00	3	007280717
19	44	100	67	25,00	3	007280719
22	44	100	67	29,50	3	007280722
24	44	100	67	29,50	3	007280724

728ME/C6

6 Sechskant-Kraftsteckschlüssel



728ME/C6	€		
12-14-17-19-22-24 mm	285,00	1	007280906

335x145x60 mm - 4,0 kg

728L

Kraftsteckschlüssel,
lange Ausführung



"	Ø mm	L mm	Ø1 mm	€		
17	30	90	44	34,50	2	007280317
19	32,5	90	44	34,50	2	007280319
21	35,0	90	44	34,50	2	007280321
22	36,0	90	44	34,50	2	007280322
24	38,5	90	44	34,50	2	007280324
26	41,0	90	44	34,50	2	007280326
27	42,5	90	44	34,50	2	007280327
30	46,0	90	44	35,50	2	007280330
32	48,5	90	44	38,00	2	007280332
33	50,0	90	44	41,00	1	007280333
34	51,0	90	44	43,00	1	007280334
36	53,5	90	44	45,00	1	007280336
38	56,0	90	44	52,00	1	007280338
41	60,0	90	44	53,00	1	007280341
44	64,0	90	44	61,50	1	007280344
46	66,0	90	44	61,50	1	007280346
50	71,0	90	44	73,00	1	007280350
55	77,5	100	54	95,50	1	007280355



728L/S3	€		
30-32-36 mm	119,00	1	007280393

728LS

Kraftsteckschlüssel, für Schlagschrauber,
lange, schmale Ausführung



"	Ø mm	L mm	Ø1 mm	€		
17	28,0	100	43	38,50	2	007280517
19	30,5	100	43	38,50	2	007280519
22	34,3	100	43	40,50	2	007280522
24	36,8	100	43	40,50	2	007280524
27	40,5	100	43	40,50	2	007280527
30	44,3	100	43	40,50	2	007280530
32	46,8	100	43	43,00	2	007280532
33	48,0	100	43	44,00	2	007280533
36	51,8	100	43	51,00	1	007280536

728LQ

Kraftsteckschlüssel
lange Ausführung
(für Radmuttern ISUZU)



"	L mm	Ø mm	Ø1 mm	€		
19	90	35	43,5	35,00	1	007280619
21	90	42	43,5	35,00	1	007280621

728/15

Reduzierstück, Innenvierkant 3/4",
Außenvierkant 1/2"



L mm	Ø mm	□	■	€		
58	38	3/4	1/2	27,50	2	007280810



Die Torsionslast muss unbedingt angemessen und stufenweise aufgebracht werden, um Bruch oder zufällige Beschädigung zu vermeiden.

728/16

Verbindungsstück, Innenvierkant 3/4",
Außenvierkant 1"



L mm	Ø mm	□	■	€		
62	44	3/4	1	33,00	2	007280813

728/21

Verlängerung,
Innen- und Außenvierkant 3/4"



L mm	Ø mm	€		
175	44	41,00	2	007280815

728/22

Verlängerung,
Innen- und Außenvierkant 3/4"

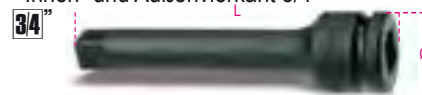

L mm	Ø mm	€		
250	44	47,50	2	007280825

728/22L

Verlängerung,
Innen- und Außenvierkant 3/4"

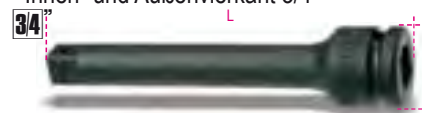

L mm	Ø mm	€		
330	44	59,50	1	007280826

728/25

Kardangeln,
Innen- und Außenvierkant 3/4"



L mm	Ø mm	€	1	007280830
107,5	44	79,00		

728/OR - 728/SP

Gummiringe, Sicherungsstifte
und Zubehör für Kraftsteckschlüssel



728/OR-15	728/OR	728/SP	728	728FTX	€	5	10	007280925	007280926	007280916
17+46	17+46	17+46	E20+E24	E20+E24	2,20					
					2,30					
					2,70					

729

Kraftsteckschlüssel, für Schlagschrauber,
Standardausführung



UNI/ISO 2725 DIN 3129

Ø mm	Ø mm	L mm	Ø1 mm	€	1	007290024
24	41,5	58	54	35,00		
27	45,0	60	54	35,00		
30	49,0	62	54	35,00		
32	51,5	63	54	35,50		
33	52,5	63	54	35,50		
34	54,0	63	54	35,50		
36	56,5	66	54	35,50		
38	59,0	66	54	43,50		
41	62,5	68	54	44,00		
46	69,0	72	54	49,50		
50	74,0	76	54	61,50		
55	80,0	84	54	65,00		
60	86,5	88	54	79,00		
65	92,5	92	54	90,00		
70	99,0	96	54	115,50		
75	105,0	102	63	135,50		
80	111,5	102	63	145,50		

729L

Kraftsteckschlüssel, für Schlagschrauber,
lange Ausführung



Ø mm	Ø mm	L mm	Ø1 mm	€	1	007290324
24	41,5	108	54	62,00		
27	45,0	108	54	62,00		
30	49,0	108	54	62,00		
32	51,5	108	54	62,00		
33	52,2	108	54	63,50		
34	54,0	108	54	63,50		
36	56,5	108	54	63,50		
41	62,5	108	54	75,50		
46	69,0	108	54	87,00		
50	74,0	108	54	98,00		

Ø mm	Ø mm	L mm	Ø1 mm	€	1	007290355
55	80,0	108	54	116,00		
60	86,5	108	54	126,00		
65	92,5	108	54	152,50		
70	99,0	108	54	173,00		
75	105,0	108	63	195,50		
80	111,5	108	63	205,50		

729LS

Kraftsteckschlüssel, für Schlagschrauber,
lange, schmale Ausführung



Ø mm	Ø mm	L mm	Ø1 mm	€	1	007290522
22	36,0	108	53	62,00		
24	38,5	108	53	62,00		
27	46,0	108	53	62,00		
30	50,0	108	53	66,00		
32	50,0	108	53	66,00		
33	52,0	108	53	66,00		
36	56,0	108	53	66,00		

729T

Maschinentorsionsstäbe für Radmuttern



Ø mm	Nm	L mm	€	1	007290724
24	350	300	139,00		
27	450	300	139,00		
30	500	300	139,00		
32	450	300	143,00		
32	600	300	143,00		
33	600	300	149,50		
36	600	300	158,50		

729/15

Reduzierstück, Innenvierkant 1",
Außenvierkant 3/4"



L mm	Ø mm	□	■	€	1	007290810
66,5	54	1	3/4	42,00		



Die Torsionslast muss unbedingt angemessen
und stufenweise aufgebracht werden,
um Bruch oder zufällige Beschädigung
zu vermeiden.

729/16

Reduzierstück, Innenvierkant 1",
Außenvierkant 1.1/2"



L mm	Ø mm	□	■	€	1	007290813
88	54,0	1	1.1/2	68,50		

729/21

Verlängerung,
Innen- und Außenvierkant 1"



L mm	Ø mm	€	1	007290815
175	54	64,00		

729/21L

Verlängerung für Maschineneinsatz, Innen-
und Außenvierkant 1"



L mm	Ø mm	€	1	007290826
250	54	72,00		

729/22

Verlängerung,
Innen- und Außenvierkant 1"



L mm	Ø mm	€	1	007290825
330	54	91,50		

729/25

Kardangeln,
Innen- und Außenvierkant 1"



L mm	Ø mm	€	1	007290830
130	54	132,50		

729/OR... - 729/SP...

Gummiringe, Sicherungsstifte
und Zubehör für Kraftsteckschlüssel



729/OR1	728	729-730	€	5	007290927
	50+60	24+70	2,10		
729/OR2		75+125	3,20		
729/SP1	50+60	24+70	2,00		
729/SP2		75+125	3,20		

730

Kraftsteckschlüssel, für Schlagschrauber, Standardausführung



UNI/ISO 2725 DIN 3129

Ø mm	Ø mm	L mm	Ø1 mm	€	1	007300050
50	81	87	84	208,50	1	007300050
55	88	90	86	213,50	1	007300055
60	94	95	86	236,00	1	007300060
65	100	100	86	259,00	1	007300065
70	106	105	86	306,00	1	007300070
75	113	110	86	355,00	1	007300075
80	119	115	86	404,00	1	007300080
85	125	120	86	450,00	1	007300085
90	132	125	86	512,00	1	007300090
95	138	125	96	595,00	1	007300095
100	144	130	96	692,00	1	007300100
105	150	135	96	770,00	1	007300105
110	157	140	96	836,00	1	007300110
115	163	140	96	899,00	1	007300115
120	169	145	96	1.006,00	1	007300120
125	175	145	96	1.051,00	1	007300125

730L

Kraftsteckschlüssel, lange Ausführung

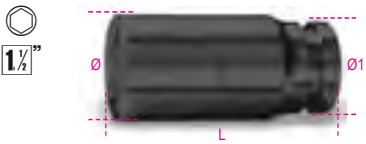

Ø mm	Ø mm	L mm	Ø1 mm	€	1	007300350
50	81	135	86	291,00	1	007300350
55	87	140	86	299,00	1	007300355
60	93	150	86	331,00	1	007300360
65	97	150	86	362,00	1	007300365
70	105	160	86	428,00	1	007300370
75	110	170	86	497,00	1	007300375
80	116	170	86	569,00	1	007300380
85	125	170	86	629,00	1	007300385
90	130	170	86	716,00	1	007300390
95	137	180	95	834,00	1	007300395
100	144	190	95	968,00	1	007300400
105	150	190	95	1.077,00	1	007300405
110	156	200	95	1.172,00	1	007300410
115	160	200	95	1.260,00	1	007300415
120	168	210	95	1.410,00	1	007300420

730/15

Verbindungsstück



L mm	Ø mm	□	■	€	1	007300810
105	84,0	1.1/2	1	143,00	1	007300810



Die Torsionslast muss unbedingt angemessen und stufenweise aufgebracht werden, um Bruch oder zufällige Beschädigung zu vermeiden.

730/21

Verlängerung für Maschineneinsatz, Innen- und Außenvierkant 1.1/2"



L mm	Ø mm	€	1	007300822
250	86	522,00	1	007300822

730/25

Kardangelnk für Maschineneinsatz, Innen- und Außenvierkant 1.1/2"



L mm	Ø mm	€	1	007300830
150	86	547,00	1	007300830

733/15

Verbindungsstück



L mm	Ø mm	□	■	€	1	007330810
156	127	2.1/2	1.1/2	502,00	1	007330810



SCHRAUBEINSÄTZE

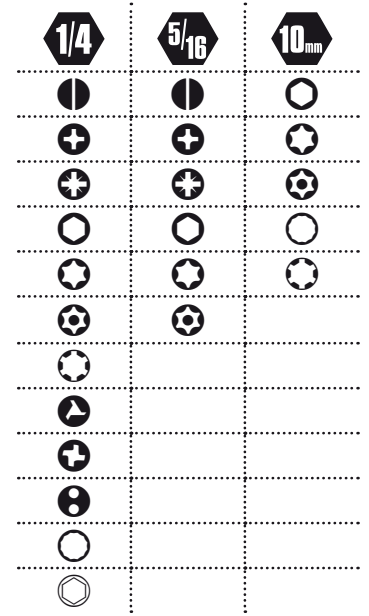

ISO 1173-C 6,3



Aufnahme für Haltefeder

ISO 1173-E 6,3



Hohlraum für Haltekugel

851

Magnetischer Schraubeinsatzhalter mit Griff



L1 mm	L mm	€	2	008510165
45	165	19,00	2	008510165
125	245	22,00	2	008510245

851SR

Einsatzhalter, mit Schnellanschluss und Griff



L mm	L1 mm	€	2	008510001
230	110	26,50	2	008510001

852 T-Gelenkgriff

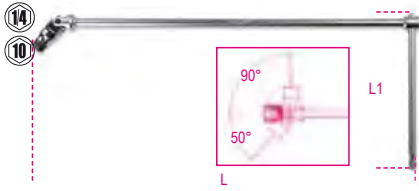

Ø	L mm	L1 mm	€	Hand	PC
1/4"	400	160	54,50	2	008520006
10 mm	400	160	54,50	2	008520010

855P Einsatzhalter mit Umschaltknarre und Gelenkgriff, 7 Einsätze enthalten

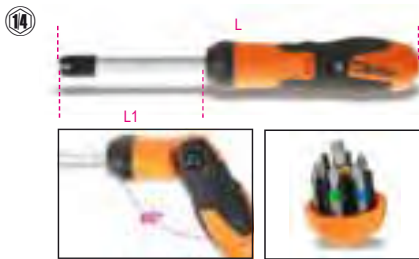

L mm	L1 mm	€	Hand	PC
240	100	86,00	1	008550010

	+	860PH	PH1 - PH2
	+	860PZ	PZ1 - PZ2
	●	860LP	LP 0,8x5,5 mm
	○	860PE	4 - 5 mm

860LP Farbige Schraubeinsätze für Schlitzschrauben



ISO 2351-1
ISO 1173 C 6,3

SxA mm	L mm	€	Hand	PC
0,5x3	25	2,40	5	008600005
0,6x4,5	25	2,40	5	008600010
0,8x5,5	25	2,40	5	008600015
1x5,5	25	2,40	5	008600020
1,2x6,5	25	2,40	5	008600025

860PH Farbige Schraubeinsätze für Phillips®-Schrauben



ISO 2351-2
ISO 1173 C 6,3

PH	L mm	€	Hand	PC
0	25	2,40	5	008600220
1	25	2,40	5	008600225
2	25	2,40	5	008600230
3	25	2,40	5	008600245
4	25	3,30	5	008600250

860PZ Farbige Schraubeinsätze für Pozidriv®- und Supadriv®-Schrauben



ISO 2351-2
ISO 1173 C 6,3

PZ	L mm	€	Hand	PC
1	25	2,40	5	008600320
2	25	2,40	5	008600325
3	25	2,40	5	008600330
4	25	3,30	5	008600335

860PE Farbige Sechskant-Schraubeinsätze



ISO 2351-3
ISO 1173 C 6,3

mm	L mm	€	Hand	PC
2	25	2,50	5	008600101
2,5	25	2,50	5	008600102
3	25	2,50	5	008600103
4	25	2,50	5	008600104
5	25	2,50	5	008600105
6	25	2,50	5	008600106
8	25	3,10	5	008600108
10	25	3,10	5	008600110

860TX Farbige Schraubeinsätze für Torx®-Schrauben



ISO 1173 C 6,3

Ø	L mm	€	Hand	PC
T6	25	3,10	5	008600704
T7	25	3,10	5	008600705
T8	25	3,10	5	008600710
T9	25	3,10	5	008600715
T10	25	2,50	5	008600720
T15	25	2,50	5	008600725
T20	25	2,50	5	008600730
T25	25	2,50	5	008600735
T27	25	2,50	5	008600740
T30	25	2,50	5	008600745
T40	25	2,50	5	008600750

860RTX Farbige Schraubeinsätze für Sicherheitsschrauben Tamper Resistant Torx®



ISO 1173 C 6,3

Ø	L mm	€	Hand	PC
T9	25	3,30	5	008600550
T10	25	3,30	5	008600555
T15	25	3,30	5	008600560
T20	25	3,30	5	008600565
T25	25	3,30	5	008600570
T27	25	3,30	5	008600575
T30	25	3,30	5	008600580
T40	25	3,30	5	008600585

860/55 Umschaltknarre für Einsatzhalter



L mm	Ø	€	Hand	PC
100	1/4	38,50	3	008600870

860/58 Knarre für Einsatzhalter mit Drehgriff

- Der Einsatz kann an beiden Seiten zum An- oder Abschrauben eingesetzt werden
- Bi-Material-Griff



L mm	Ø mm	A mm	€	Hand	PC		
860/58	126	1/4"	27	15	88,00	1	008600884

860/C27 Sortiment mit 25 Schraubeinsätzen, 1 Anschluss und 1 Umschaltknarre, mit Hülle im Taschenformat



€	Hand	PC
104,50	1	008600880

	860/55	100 mm
	860LP	0,5x3-1,0x5,5-1,2x6,5 mm
	860PH	PH1-PH2(x2)-PH3
	860PZ	PZ1-PZ2(x2)-PZ3
	860PE	2-2,5-3-4-5-6 mm
	860TX	T6-T8-T10-T15-T20-T25-T30-T40
	892/0	● 1/4 ■ 1/4

860PHZ/A10 Sortiment mit 10 Schraubeinsätzen und magnetischer Schraubeinsatzhalter, im Kunststoffkasten



€	Hand	PC
44,00	1	008600910

	860PH	PH1	n.
		PH2	1
		PH3	3
	860PZ	PZ1	1
		PZ2	3
		PZ3	1
	882M1	○ 1/4 ● 1/4	

860PE/A10

Sortiment mit 10 Schraubeinsätzen und magnetischer Schraubeinsatzhalter, im Kunststoffkasten



860PE/A10 € 45,50 1 008600920

	860PE	2 - 2,5 mm	n.
	882M1	3 - 4 - 5 - 6 mm	1
		○ 1/4 ● 1/4	2

860TX/A10

Sortiment mit 10 Schraubeinsätzen und magnetischer Schraubeinsatzhalter, im Kunststoffkasten



860TX/A10 € 46,50 1 008600970

	860TX	T7 - T8 - T9 - T10 - T15 - T20	n.
	882M1	T25 - T27 - T30 - T40	1
		○ 1/4 ● 1/4	1

860MIX/A10

Sortiment mit 10 Schraubeinsätzen und magnetischer Schraubeinsatzhalter, im Kunststoffkasten



860MIX/A10 € 44,00 1 008600900

	860LP	0,5x3 - 1x5,5 - 1,2x6,5 mm	n.
	860PH	PH1	1
		PH2	2
		PH3	1
	860PZ	PZ1 - PZ2 - PZ3	1
	882M1	○ 1/4 ● 1/4	1

860MIX/A31

Sortiment mit 30 Schraubeinsätzen und magnetischer, schnellauslösender Schraubeinsatzhalter, im Kunststoffkasten



860MIX/A31 € 103,00 1 008600902

	860LP	0,5x3 - 0,6x4,5 - 0,8x5,5 1,0x5,5 - 1,2x6,5 mm
	860PE	2 - 2,5 - 3 - 4 - 5 - 6 8 - 10 mm
	860PH	PH0 - PH1 - PH2 - PH3 - PH4
	860PZ	PZ1 - PZ2 - PZ3 - PZ4
	860RTX	T9 - T10 - T15 - T20 T25 - T27 - T30 - T40
	882MSR 50	○ 1/4 ● 1/4

860/C38P

1 Einsatzhalter mit Umschaltknarre und Griff, 27 Schraubeinsätze, 8 Sechskant-Steckschlüssel und 2 Zubehörteile



860/C38P € 227,00 1 008600878

	860LP	0,6x4,5-0,8x5,5-1,0x5,5-1,2x6,5 mm
	860PE	2-2,5-3-4(x2)-5(x2) mm
	860PH	PH1(x2)-PH2(x2)-PH3
	860PZ	PZ1(x2)-PZ2(x2)-PZ3
	860TX	T10-T15-T20-T25-T30-T40
	900	5-5,5-6-7-8-9-10-13 mm
	892/0	● 1/4 ■ 1/4
	892/3	● 1/4 ■ 1/4
	855P	240 mm

270x120x45 mm

861LP

Schraubeinsätze für Schlitzschrauben



ISO 2351-1

ISO 1173 C 6,3

SxA mm	L mm	€	10	20
0,5x3	25	1,50	10	008610005
0,6x4	25	1,50	10	008610007
0,6x4,5	25	1,50	10	008610010
0,8x5,5	25	1,50	10	008610015
1x5,5	25	1,50	10	008610020
1,2x6,5	25	1,50	10	008610025
1,2x8	25	2,80	10	008610028
1,6x8	25	2,80	10	008610030

861PH

Schraubeinsätze für Phillips®-Schrauben



ISO 2351-2

ISO 1173 C 6,3

PH	L mm	€	10	20
0	25	1,50	10	008610200
1	25	1,50	10	008610205
2	25	1,50	10	008610210
2L	50	2,80	10	008610213
3	25	1,50	10	008610215
4	25	3,90	10	008610220

861PH/C

Schraubeinsätze für Phillips®-Schrauben

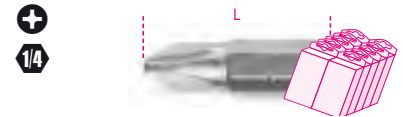

ISO 2351-2

ISO 1173 C 6,3

PH	L mm	€	200	400
0	25	1,30	200	008610250
1	25	1,30	200	008610255
2	25	1,30	200	008610260
2L	50	2,20	100	008610263
3	25	1,30	200	008610265
4	25	2,80	100	008610270

861PZ

Schraubeinsätze für Pozidriv®- und Supadriv®-Schrauben



ISO 2351-2

ISO 1173 C 6,3

PZ	L mm	€	10	20
1	25	1,50	10	008610300
2	25	1,50	10	008610305
2L	50	2,80	10	008610308
3	25	1,50	10	008610310
4	25	3,90	10	008610315



861PZ/C

Schraubeinsätze
für Pozidriv®- und Supadriv®-Schrauben

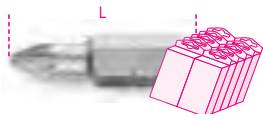

ISO 2351-2
ISO 1173 C 6,3

PZ	L mm	€	🛒	📄
1	25	1,30	200	008610350
2	25	1,30	200	008610355
2L	50	2,20	100	008610358
3	25	1,30	200	008610360
4	25	2,80	100	008610365

861PE

Sechskant-Schraubeinsätze



ISO 2351-3
ISO 1173 C 6,3

mm	L mm	€	🛒	📄
2	25	1,60	10	008610100
2,5	25	1,60	10	008610105
3	25	1,60	10	008610110
4	25	1,60	10	008610115
5	25	1,60	10	008610120
6	25	1,60	10	008610125
8	25	2,40	10	008610130
10	25	3,20	10	008610135

861TX

Schraubeinsätze für Torx®-Schrauben



ISO 1173 C 6,3

⊖	L mm	€	🛒	📄
T5	25	2,20	10	008610399
T6	25	2,20	10	008610400
T7	25	2,20	10	008610405
T8	25	2,20	10	008610410
T9	25	2,20	10	008610415
T10	25	1,70	10	008610420
T15	25	1,70	10	008610425
T20	25	1,70	10	008610430
T25	25	1,70	10	008610435
T27	25	1,70	10	008610440
T30	25	1,70	10	008610445
T40	25	1,70	10	008610450

861TX/C

Schraubeinsätze für Torx®-Schrauben

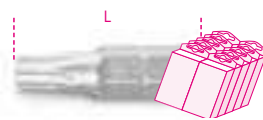

ISO 1173 C 6,3

⊖	L mm	€	🛒	📄
T10	25	1,30	200	008610470
T15	25	1,30	200	008610475
T20	25	1,30	200	008610480
T25	25	1,30	200	008610485
T27	25	1,30	200	008610490
T30	25	1,30	200	008610495
T40	25	1,30	200	008610499

861RTX

Schraubeinsätze für Sicherheitsschrauben
Tamper Resistant Torx®



ISO 1173 C 6,3

⊖	L mm	€	🛒	📄
T6	25	3,10	10	008610537
T7	25	3,10	10	008610538
T8	25	3,10	10	008610540
T9	25	3,10	10	008610500
T10	25	3,10	10	008610505
T15	25	3,10	10	008610510
T20	25	3,10	10	008610515
T25	25	3,10	10	008610520
T27	25	3,10	10	008610525
T30	25	3,10	10	008610530
T40	25	3,10	10	008610535
T45	25	5,90	10	008610539

861RIBE

Schraubeinsätze für RIBE®-Schrauben



ISO 1173 C 6,3

⊖	L mm	€	🛒	📄
M5	25	1,40	10	008610705
M6	25	1,40	10	008610706
M7	25	1,70	10	008610707
M8	25	1,70	10	008610708
M9	25	2,40	10	008610709

861TRW

Schraubeinsätze
für Tri-Wing®-Schrauben

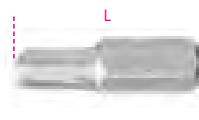

ISO 1173 C 6,3

GR	L mm	€	🛒	📄
1	25	2,60	10	008610601
2	25	2,60	10	008610602
3	25	2,60	10	008610603
4	25	2,60	10	008610604
5	25	2,60	10	008610605
6	25	3,90	10	008610606

861TQS

Schraubeinsätze
für Torq-Set®-Schrauben

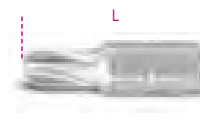

ISO 1173 C 6,3

GR	L mm	€	🛒	📄
0	25	2,60	10	008610620
1	25	2,60	10	008610621
2	25	2,60	10	008610622
3	25	2,60	10	008610623
4	25	2,60	10	008610624
5	25	2,60	10	008610625
6	25	2,60	10	008610626
8	25	2,60	10	008610628
10	25	2,60	10	008610630

861SP

Schraubeinsätze für Spannerschrauben



ISO 1173 C 6,3

SP	D mm	L mm	€	🛒	📄
4	1,5	25	2,20	10	008610650
6	2,4	25	2,20	10	008610653
8	2,8	25	2,20	10	008610656
10	3,3	25	2,20	10	008610658
12	3,9	25	2,20	10	008610660

1483KV-PT/S7



1483KV PT/S7

185

861XZN

Schraubeinsätze für XZN®-Schrauben



ISO 1173 C 6,3

⊖	L mm	€	🛒	📄
M5	25	1,40	10	008610725
M6	25	1,40	10	008610726
M8	25	1,70	10	008610728

861/C61P

61 Schraubeinsätze und 1 Einsatzhalter, magnetisch, mit Schnellanschluss



861/C61P 196,00 € 1 008610978

- 861LP 0,5x3 - 0,6x4,5 - 0,8x5,5 - 1,0x5,5
1,2x6,5 - 1,2x8 - 1,6x8 mm
- 861PE 2 - 2,5 - 3 - 4 - 5 - 6 - 8 - 10 mm
- 861PH PH0 - PH1 - PH2 - PH3
- 861PZ PZ1 - PZ2 - PZ3
- 861TX T6 - T7 - T8 - T9 - T10 - T15
T20 - T25 - T27 - T30 - T40
- 861RTX T9 - T10 - T15 - T20 - T25
T27 - T30 - T40
- 861TRW 1 - 2 - 3 - 4 - 5 - 6
- 861TQS 0 - 1 - 2 - 3 - 4 - 5 - 6 - 8 - 10
- 861SP 4 - 6 - 8 - 10 - 12
- 851SR 1/4"

270x120x45 mm - 975 g

862LP

Schraubeinsätze für Schlitzschrauben



ISO 2351-1

ISO 1173 E 6,3

SxA mm	L mm	€	5	10
0,5x3	50	4,30	5	008620005
0,6x4,5	50	4,30	5	008620010
0,8x5,5	50	4,30	5	008620015
1x5,5	50	4,30	5	008620020
1,2x6,5	50	4,30	5	008620025
1,2x8	50	5,30	5	008620030
1,6x8	50	5,30	5	008620035

862PH

Schraubeinsätze für Phillips®-Schrauben



ISO 2351-2

ISO 1173 E 6,3

PH	L mm	€	5	10
1	50	4,40	5	008620200
2	50	4,40	5	008620205
3	50	4,40	5	008620210

862PH/L

Schraubeinsätze für Phillips®-Schrauben



ISO 2351-2

ISO 1173 E 6,3

PH	L mm	€	5	10
1	70	7,80	5	008620230
2	70	7,80	5	008620232
3	70	7,80	5	008620234

862PH-XL

Schraubeinsätze für Phillips®-Schrauben



ISO 2351-2/ISO 1173 E 6,3

PH	L mm	€	5	10
1	100	8,10	5	008620250
2	100	8,10	5	008620252
3	100	8,10	5	008620254

862PZ

Schraubeinsätze für Pozidriv®- und Supadriv®-Schrauben

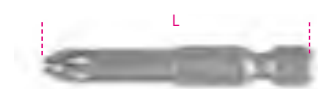

ISO 2351-2

ISO 1173 E 6,3

PZ	L mm	€	5	10
1	50	4,50	5	008620300
2	50	4,50	5	008620305
3	50	4,50	5	008620310

862PE

Sechskant-Schraubeinsätze



ISO 2351-3

ISO 1173 E 6,3

mm	L mm	€	5	10
3	50	4,40	5	008620103
4	50	4,40	5	008620104
5	50	4,40	5	008620105
6	50	4,40	5	008620106
8	50	5,90	5	008620108

862TX

Schraubeinsätze für Torx®-Schrauben



ISO 1173 E 6,3

T	L mm	€	5	10
T6	50	5,90	5	008620506
T7	50	5,90	5	008620507
T8	50	5,90	5	008620508
T9	50	5,90	5	008620509
T10	50	5,90	5	008620510
T15	50	5,90	5	008620515
T20	50	5,90	5	008620520
T25	50	5,90	5	008620525
T27	50	5,90	5	008620527
T30	50	5,90	5	008620530
T40	50	5,90	5	008620540

862TX/L

Schraubeinsätze für Torx®-Schrauben



ISO 1173 E 6,3

T	L mm	€	5	10
T6	70	6,40	5	008620556
T7	70	6,40	5	008620557
T8	70	6,40	5	008620558
T9	70	6,40	5	008620559
T10	70	6,40	5	008620560
T15	70	6,40	5	008620565
T20	70	6,40	5	008620570
T25	70	6,40	5	008620575
T27	70	6,40	5	008620577
T30	70	6,40	5	008620580
T40	70	6,40	5	008620590

862TX-XL

Schraubeinsätze für Torx®-Schrauben



ISO 1173 E 6,3

T	L mm	€	5	10
T9	100	6,90	5	008620659
T10	100	6,90	5	008620660
T15	100	6,90	5	008620665
T20	100	6,90	5	008620670
T25	100	6,90	5	008620675
T27	100	6,90	5	008620677
T30	100	6,90	5	008620680
T40	100	6,90	5	008620690



862F

Sechskant-Schraubendrehereinsätze, magnetisch



ISO 1173 E 6,3

mm	L mm	Ø mm	€	📦	📄
5,5	65	11	7,90	5	008620405
6	65	11	7,90	5	008620406
7	65	11	7,90	5	008620407
8	65	13	7,90	5	008620408
10	65	15	8,60	5	008620410
12	65	18	9,60	5	008620412
13	65	18	10,10	5	008620413

862F/A7

Sortiment mit 7 Sechskant-Schraubendrehereinsätzen, magnetisch, mit Hülle im Taschenformat



862F/A7 € 59,50 📦 1 📄 008620950

862F 5,5-6-7-8-10-12-13 mm

862XP/A16

Satz mit 16 Impact-Einsätzen im Taschenetui



862XP/A16 € 80,00 📦 1 📄 008620960

- ➕ PH2(x2)-PH3
- ➕ PZ2(x2)-PZ3
- ⊕ T20-T25(x2)
- ⊕ T30(x2)-T40(x2)
- 4-5-6 mm



866LP

Schraubeinsätze für Schlitzschrauben



ISO 2351-1
ISO 1173 C 8

SxA mm	L mm	€	📦	📄
1x5,5	41	4,50	10	008660005
1,2x6,5	41	4,50	10	008660010
1,6x8	41	4,50	10	008660015
1,6x10	41	5,90	10	008660020
2x12	41	7,40	10	008660025

866PH

Schraubeinsätze für Phillips®-Schrauben



ISO 2351-2
ISO 1173 C 8

PH	L mm	€	📦	📄
1	32	3,60	10	008660200
2	32	3,60	10	008660205
3	32	3,60	10	008660210
4	38	5,40	10	008660215

866PZ

Schraubeinsätze für Pozidriv®- und Supadriv®-Schrauben



ISO 2351-2
ISO 1173 C 8

PZ	L mm	€	📦	📄
1	32	3,80	10	008660300
2	32	3,80	10	008660305
3	32	3,80	10	008660310
4	38	5,70	10	008660315

866PE

Sechskant-Schraubeinsätze



ISO 2351-3
ISO 1173 C 8

mm	L mm	€	📦	📄
3	30	3,10	10	008660100
4	30	3,10	10	008660105
5	30	3,10	10	008660110
6	30	3,10	10	008660115
7	30	3,10	10	008660117
8	30	3,10	10	008660120
10	30	4,30	10	008660125
12	30	5,90	10	008660132
14	30	7,60	10	008660134

866TX

Schraubeinsätze für Torx®-Schrauben



ISO 1173 C 8

	L mm	€	📦	📄
T20	30	3,90	10	008660400
T25	30	3,90	10	008660405
T27	30	3,90	10	008660410
T30	30	3,90	10	008660415
T40	30	3,90	10	008660420
T45	30	3,90	10	008660425
T50	30	3,90	10	008660430
T55	30	5,50	10	008660435
T60	30	7,40	10	008660440
T70	30	8,20	10	008660445

866RTX

Schraubeinsätze für Sicherheitsschrauben Tamper Resistant Torx®



ISO 1173 C 8

	L mm	€	📦	📄
T40	30	4,50	10	008660520
T45	30	4,50	10	008660525
T50	30	4,50	10	008660530
T55	30	6,10	10	008660535
T60	30	7,90	10	008660540
T70	30	9,90	10	008660545

867PE

Sechskant-Schraubeinsätze



mm	L mm	€	📦	📄
4	30	2,10	5	008670104
5	30	2,10	5	008670105
6	30	2,10	5	008670106
7	30	2,10	5	008670107
8	30	2,10	5	008670108
10	30	2,10	5	008670110
12	30	3,10	5	008670112

867PE/L

Sechskant-Schraubeinsätze



mm	L mm	€	📦	📄
4	75	3,80	5	008670154
5	75	3,80	5	008670155
6	75	3,80	5	008670156
7	75	3,80	5	008670157
8	75	3,80	5	008670158
10	75	3,80	5	008670160
12	75	5,20	5	008670162

867XZN

Schraubeinsätze für Vielzahnschrauben (XZN®)



Ø	L mm	€	U	PC
M4	30	2,50	5	008670204
M5	30	2,50	5	008670205
M6	30	2,50	5	008670206
M8	30	2,50	5	008670208
M10	30	2,50	5	008670210
M12	30	3,80	5	008670212

867XZN/L

Schraubeinsätze für Vielzahnschrauben (XZN®)



Ø	L mm	€	U	PC
M5	75	4,20	5	008670255
M6	75	4,20	5	008670256
M8	75	4,20	5	008670258
M10	75	4,20	5	008670260
M12	75	5,60	5	008670262

867TX

Schraubeinsätze für Torx®-Schrauben



Ø	L mm	€	U	PC
T20	30	2,10	5	008670400
T25	30	2,10	5	008670405
T30	30	2,10	5	008670410
T40	30	2,10	5	008670415
T45	30	2,10	5	008670420
T50	30	2,10	5	008670425
T55	30	2,10	5	008670430

867TX/L

Schraubeinsätze für Torx®-Schrauben



Ø	L mm	€	U	PC
T20	75	3,30	5	008670450
T25	75	3,30	5	008670455
T30	75	3,30	5	008670460
T40	75	3,30	5	008670465
T45	75	3,30	5	008670470
T50	75	3,30	5	008670475
T55	75	3,30	5	008670480

867RTX

Schraubeinsätze für Sicherheitsschrauben Tamper Resistant Torx®



Ø	L mm	€	U	PC
T20	30	2,30	5	008670500
T25	30	2,30	5	008670505
T30	30	2,30	5	008670510
T40	30	2,30	5	008670515
T45	30	2,30	5	008670520
T50	30	2,30	5	008670525
T55	30	2,30	5	008670530

867RTX/L

Schraubeinsätze für Sicherheitsschrauben Tamper Resistant Torx®



Ø	L mm	€	U	PC
T20	75	3,80	5	008670550
T25	75	3,80	5	008670555
T30	75	3,80	5	008670560
T40	75	3,80	5	008670565
T45	75	3,80	5	008670570
T50	75	3,80	5	008670575
T55	75	3,80	5	008670580

867RIBE

Schraubeinsätze für RIBE®-Schrauben



Ø	L mm	€	U	PC
M5	30	2,40	5	008670705
M6	30	2,40	5	008670706
M7	30	2,40	5	008670707
M8	30	2,40	5	008670708
M9	30	2,40	5	008670709
M10	30	2,40	5	008670710
M11	30	3,40	5	008670711
M12	30	3,40	5	008670712
M13	30	3,40	5	008670713

867RIBE/L

Schraubeinsätze für RIBE®-Schrauben



Ø	L mm	€	U	PC
M5	75	3,80	5	008670755
M6	75	3,80	5	008670756
M7	75	3,80	5	008670757
M8	75	3,80	5	008670758
M9	75	3,80	5	008670759
M10	75	3,80	5	008670760
M11	75	5,10	5	008670761
M12	75	5,10	5	008670762
M13	75	5,10	5	008670763

867/...

Einsatzhalter für Schraubeinsätze Art. 867



Ø	mm	□	L mm	Ø mm	€	U	PC
867/1	10	3/8"	38	17	7,10	5	008670600
867/2	10	1/2"	38	22	8,00	5	008670601

867/C20

18 Sechskant-Schraubeinsätze für RIBE®-Schrauben mit Sechskantanschluss und 2 Betätigungswerkzeuge



867/C20	€	U	PC
	141,00	1	008670920

867RIBE	5-6-7-8-9-10-11-12-13 mm
867RIBE/L	5-6-7-8-9-10-11-12-13 mm
867/1	
867/2	
335x145x60 mm - 1,7 kg	

867/C38

38 Sechskant-Schraubeinsätze, 10 mm, und 1 Schraubeinsatzhalter mit T-Gelenkgriff



867/C38	€	U	PC
	258,00	1	008670938

852	10 mm
867PE	4-5-6-7-8-10-12mm
867PE/L	4-5-6-7-8-10-12mm
867XZN	M5-M6-M8-M10-M12
867XZN/L	M5-M6-M8-M10-M12
867TX	T20-T25-T30-T40-T45-T50-T55
867TX/L	T20-T25-T30-T40-T45-T50-T55
882	
420x185x60 mm - 3 kg	

867/C52

52 Sechskant-Schraubeinsätze, 10 mm, und 2 Betätigungswerkzeuge



867/C52 € 160,00 1 008670901

	○ 867PE	4-5-6-7-8-10-12 mm
	○ 867PE/L	4-5-6-7-8-10-12 mm
	○ 867XZN	M5-M6-M8-M10-M12
	○ 867XZN/L	M5-M6-M8-M10-M12
	⊕ 867TX	T20-T25-T30-T40-T45-T50-T55
	⊕ 867TX/L	T20-T25-T30-T40-T45-T50-T55
	⊕ 867RTX	T20-T25-T30-T40-T45-T50-T55
	⊕ 867RTX/L	T20-T25-T30-T40-T45-T50-T55
	867/1	○ 10 mm - □ 3/8"
	867/2	○ 10 mm - □ 1/2"

250x170x70 mm - 2,1 kg

852



852 1/4 79,116

882

Schraubeinsatzhalter mit Verriegelungsring



ISO 1173 E 6,3

L mm	○	●	∅ mm	€		
57	1/4	1/4	11	19,70	5	008820001

882AN

Winkelkopf Sechskantanschluss 1/4"

- Für Elektrobohrmaschinen mit Bohrfutter 10 und 13 mm und Schlagschrauber mit Anschluss 1/4"
- Max. Drehzahl 3600 U/min.
- Max. Moment 30 Nm
- Mit Schnellwechsel-Einsatzhalter
- Übersetzung 1:1
- Verbindung mit dem Werkzeug mittels Sechskant 1/4" D6.3



ISO 1173 E 6,3
ISO 1173 C 6,3

L mm	○	●	€		
137	1/4	1/4	85,00	1	008820090

882M1

Schraubeinsatzhalter mit Magnethalter



ISO 1173 E 6,3

L mm	○	●	∅ mm	€		
50	1/4	1/4	11	20,80	5	008820006

882M

Schraubeinsatzhalter mit Magnethalter



ISO 1173 E 6,3

L mm	○	●	∅ mm	€		
75	1/4	1/4	11	25,00	5	008820005

882MSR

Magnetischer Schraubeinsatzhalter mit Verriegelungsring, mit schneller Auslösung



ISO 1173 E 6,3

L mm	○	●	∅ mm	€		
50	1/4	1/4	11	22,50	5	008820205
75	1/4	1/4	11	26,50	5	008820207

882P

Magnetverlängerung für Einsatzhalter



L mm	●	○	∅ mm	€		
80	1/4	1/4	10	18,40	5	008820080

892

Adapter für Steckschlüssel



892/0
892/1
892/2
892/3
892/4
892/5
892/6
892/7

	■	●	L mm	€		
892/0	1/4	1/4	25	6,50	5	008920000
* 892/1	1/4	5,5	50	12,40	5	008920001
* 892/2	3/8	5,5	50	18,30	5	008920002
° 892/3	1/4	1/4	50	12,40	5	008920003
° 892/4	3/8	1/4	50	18,30	5	008920004
892/5	1/4	5/16	75	16,90	5	008920005
892/6	3/8	5/16	75	24,80	5	008920006
892/7	1/2	1/4	75	26,00	5	008920007

* ISO 1173 A 5,5
° ISO 1173 C 6,3

895

Einsatzhalter für Schraubeinsätze Art. 861 - 862 - 866



DIN 7427

	○	□	L mm	∅ mm	€		
895/1	1/4	1/4	25,4	12	14,80	5	008950000
895/3	1/4	3/8	29	16,8	17,60	5	008950001
895/4	5/16	3/8	29	16,8	17,60	5	008950002
895/5	1/4	1/2	38	22	17,60	5	008950005
895/6	5/16	1/2	38	22	17,60	5	008950003

897

Flexibler Einsatzhalter mit Griff



L mm	L1 mm	€		
280	154	33,50	2	008970010

897L

Flexibler Einsatzhalter mit Griff, lange Ausführung



L mm	L1 mm	€		
500	380	38,50	2	008970015



KNARREN 9XX/55

Minimaler Raumbedarf des Kopfes



Begrenzter Manöverraum, nur 5° dank der 72 Zähne der Sperrklinke



Kein mögliches Rutschen oder Aushaken unter Belastung

- Der Druck der Hand auf den Kopf führt nicht zur Umkehr und ermöglicht immer den freien Rücklauf des Hebels
- Umkehrung mit nur einer Hand
- Optimale mechanische Eigenschaften



Reduzierung der Arbeitslast, 17 Zähne immer in Aufnahme

900 Sechskant-Steckschlüssel



UNI/ISO 2725 DIN 3124

Ø mm	Ø mm	L mm	Ø1 mm	€	5	10
3,2	6,6	25	11,8	4,70	10	009000032
4	6,8	25	11,8	4,70	10	009000040
4,5	7,4	25	11,8	4,70	10	009000045
5	8,0	25	11,8	4,70	10	009000050
5,5	8,7	25	11,8	4,70	10	009000055
6	9,3	25	11,8	4,70	10	009000060
7	10,4	25	11,8	4,70	10	009000070
8	11,8	25	12,7	4,70	10	009000080
9	12,7	25	11,8	4,70	10	009000090
10	14,2	25	12,0	4,70	10	009000100
11	15,8	25	12,5	4,70	10	009000110
12	17,2	25	13,5	4,70	10	009000120
13	18,0	25	13,5	4,70	10	009000130
14	20,0	25	15,0	4,80	10	009000140



900/SB13 € 81,00 1 009000150
4-4,5-5-5,5-6-7-8-9
10-11-12-13-14 mm

900MC Sechskant-Steckschlüssel, farbig



Ø mm	L mm	Ø mm	Ø1 mm	€	5	10
4	24,8	6,7	11,8	5,00	5	009002040
5	24,8	8,0	11,8	5,00	5	009002050
6	24,8	9,2	11,8	5,00	5	009002060
7	24,8	10,7	11,8	5,00	5	009002070
8	24,8	11,8	11,8	5,00	5	009002080
9	24,8	12,8	12,8	5,00	5	009002090
10	24,8	14,8	14,8	5,00	5	009002100
11	24,8	15,8	15,8	5,00	5	009002110
12	24,8	16,8	16,8	5,00	5	009002120
13	24,8	17,8	17,8	5,10	5	009002130
14	24,8	19,5	19,5	5,20	5	009002140



900MB Zwölfkant-Steckschlüssel



UNI/ISO 2725 DIN 3124

Ø mm	Ø mm	L mm	Ø1 mm	€	5	10
4	6,7	22	11,2	8,90	5	009000160
5	7,7	25	11,2	8,90	5	009000161
5,5	8,3	25	11,2	8,90	5	009000162
6	9,0	25	11,2	8,90	5	009000163
7	10,2	25	11,2	8,90	5	009000164
8	11,3	25	12,0	8,90	5	009000165
9	13,0	25	12,0	8,90	5	009000166
10	14,3	25	12,9	8,90	5	009000167
11	16,0	25	14,3	8,90	5	009000168
12	17,4	25	16,0	8,90	5	009000169
13	18,0	25	16,4	9,90	5	009000170
14	19,3	25	17,9	10,50	5	009000171



900MB/SB12 € 129,50 1 009000179
4-5-5,5-6-7-8-9-10
11-12-13-14 mm

900L Sechskant-Steckschlüssel, lange Ausführung



UNI/ISO 2725 DIN 3124

Ø mm	Ø mm	L mm	Ø1 mm	€	5	10
4	6,5	50	12,0	10,70	5	009000181
4,5	7,0	50	12,0	10,70	5	009000182
5	7,5	50	12,0	10,70	5	009000183
5,5	8,5	50	12,0	10,70	5	009000184
6	9,5	50	12,0	10,70	5	009000185
7	10,5	50	12,0	10,70	5	009000186
8	12,0	50	12,0	10,70	5	009000187
9	13,0	50	13,0	10,70	5	009000188
10	14,0	50	14,0	11,20	5	009000189
11	16,0	50	16,0	11,20	5	009000190
12	17,5	50	17,5	11,20	5	009000191
13	17,5	50	17,5	11,20	5	009000192
14	20,0	50	20,0	11,20	5	009000193



900L/SB13 € 163,00 1 009000203
4-4,5-5-5,5-6-7-8-9-10-11-12-13-14 mm

900MB/L

Zwölfkant-Steckschlüssel,
lange Ausführung



UNI/ISO 2725 DIN 3124

Ø mm	Ø mm	L mm	Ø1 mm	€	Hand	Computer
5	8,0	50	12,0	16,50	3	009000211
6	9,3	50	12,0	16,50	3	009000212
7	10,9	50	12,0	16,50	3	009000213
8	11,6	50	12,0	16,50	3	009000214
9	13,0	50	12,0	16,50	3	009000215
10	14,3	50	12,8	17,50	3	009000216
11	16,0	50	14,2	17,50	3	009000217
12	17,4	50	15,5	17,50	3	009000218
13	18,0	50	16,2	17,70	3	009000219
14	19,0	50	17,1	17,90	3	009000220

900AS

Sechskant-Steckschlüssel



Ø mm	Ø mm	L mm	Ø1 mm	€	Hand	Computer
5/32	8,8	25	11,9	5,10	5	009000349
3/16	7,7	25	11,9	5,10	5	009000340
7/32	8,8	25	11,9	5,10	5	009000345
1/4	9,6	25	11,9	5,10	5	009000350
9/32	10,2	25	11,9	5,10	5	009000355
5/16	11,3	25	11,9	5,10	5	009000360
11/32	12,7	25	11,6	5,10	5	009000365
3/8	14,0	25	12,9	5,10	5	009000370
7/16	15,3	25	14,5	5,10	5	009000375
1/2	17,5	25	16,4	5,20	5	009000380
9/16	19,0	25	17,9	5,20	5	009000385



900AS/SB11
3/16-7/32-5/32-1/4-9/32-5/16
11/32-3/8-7/16-1/2-9/16

€ 74,00 1 009000389

900AS/MB

Zwölfkant-Steckschlüssel

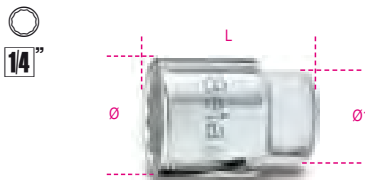

SAE AS 954E

Ø mm	Ø mm	L mm	Ø1 mm	€	Hand	Computer
3/16	7,7	22	10,9	9,00	2	009000390
7/32	8,5	22	10,9	9,00	2	009000391
1/4	9,4	22	10,9	9,00	2	009000392
9/32	10,2	22	10,9	9,00	2	009000393
5/16	11,3	22	11,7	9,00	2	009000394
11/32	12,5	22	12,0	9,00	2	009000395
3/8	13,7	22	12,9	9,70	2	009000396

Ø mm	L mm	Ø1 mm	€	Hand	Computer	
7/16	15,6	22	14,3	9,70	2	009000397
1/2	17,2	22	16,4	10,80	2	009000398
9/16	18,8	24	17,9	10,90	2	009000399

900AS/L

Sechskant-Steckschlüssel,
lange Ausführung



SAE AS 954E

Ø mm	L mm	Ø1 mm	€	Hand	Computer	
3/16	7,0	50	12,0	11,20	2	009000301
7/32	8,5	50	12,0	11,20	2	009000303
1/4	9,8	50	12,0	11,20	2	009000305
9/32	10,5	50	12,0	11,20	2	009000307
5/16	12,0	50	12,0	11,20	2	009000309
11/32	13,0	50	13,0	11,20	2	009000311
3/8	14,0	50	14,0	11,20	2	009000313
7/16	16,0	50	16,0	11,20	2	009000315
1/2	17,5	50	17,5	11,20	2	009000317
9/16	20,0	50	20,0	12,00	2	009000319

900AS/MBL

Zwölfkant-Steckschlüssel,
lange Ausführung



Ø mm	L mm	Ø1 mm	€	Hand	Computer	
5/32	6,8	50	12,0	17,40	2	009000325
3/16	8,0	50	12,0	17,40	2	009000326
7/32	8,5	50	12,0	17,40	2	009000327
1/4	9,8	50	12,0	17,40	2	009000328
9/32	10,9	50	12,0	17,40	2	009000329
5/16	11,6	50	12,0	17,40	2	009000330
11/32	13,0	50	12,0	17,40	2	009000331
3/8	14,3	50	12,8	18,50	2	009000332
7/16	16,0	50	14,2	18,50	2	009000333
1/2	18,0	50	16,2	18,50	2	009000334
9/16	19,0	50	17,1	18,50	2	009000335

900U

Multiprofil-Steckschlüssel

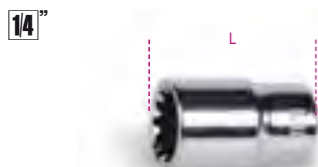

Ø mm	"	Ø	Ø	€	Hand	Computer
4	5/32	E5	M5	4,90	5	009001702
4,5	3/16	E6		4,90	5	009001703
5	13/64		M6	4,90	5	009001704
5,5	7/32	E7		4,90	5	009001705
6	1/4	E8	M8	4,90	5	009001706
7	9/32			4,90	5	009001707
8	5/16	E10	M10	4,90	5	009001708
9	11/32			4,90	5	009001709
10	3/8	E12	M12	4,90	5	009001710
11	7/16	E14	M14	4,90	5	009001711
12	15/32	E16		4,90	5	009001712
13	1/2		M16	5,00	5	009001713
14	9/16	E18	M18	5,00	5	009001714

14"



900U/SB13

4-4,5-5-5,5-6-7-8-9
10-11-12-13-14 mm

€ 84,50 1 009001750

900FTX

Steckschlüssel für Torx®-Schrauben

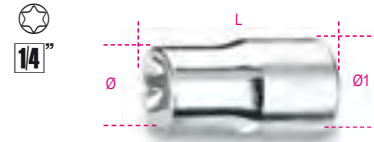

Ø mm	L mm	Ø1 mm	€	Hand	Computer	
E4	5,4	22	11,2	8,50	5	009000404
E5	6,7	22	11,2	8,50	5	009000405
E6	7,7	22	11,2	8,50	5	009000406
E7	8,3	22	11,2	8,50	5	009000407
E8	9,6	22	11,2	8,50	5	009000408
E10	11,3	22	12,0	8,50	5	009000410
E11	12,1	22	12,5	11,60	5	009000411
E12	12,9	23	12,9	11,60	5	009000412
E14	14,0	25	14,0	11,60	5	009000414



900FTX/SB9
E4-E5-E6-E7-E8
E10-E11-E12-E14

€ 101,50 1 009000419

900LP

Schraubendrehereinsätze
für Schlitzschrauben

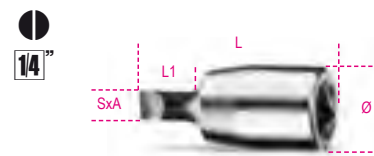

SxA mm	Ø mm	L mm	L1 mm	€	Hand	Computer
0,8x4	12	28	9	10,30	5	009000605
1x5,5	12	28	9	10,30	5	009000610
1,2x6,5	12	28	9	10,30	5	009000615
1,2x8	13	28	8	10,30	5	009000620
1,6x10	14	28	8	10,30	5	009000625

900MC/LP

Schraubendrehereinsätze
für Schlitzschrauben, farbig



SxA mm	Ø mm	L mm	L1 mm	€	Hand	Computer
0,8x4	12	28	9	16,10	3	009002605
1,2x6,5	12	28	9	16,10	3	009002615
1,2x8	13	28	8	16,10	3	009002620

900PH

Schraubendrehereinsätze
für Phillips®-Schrauben



PH	Ø mm	L mm	L1 mm	€	U	IT
1	12	28	12	11,20	5	009000701
2	12	28	12	11,20	5	009000702
3	12	28	12	11,20	5	009000703
4	13	28	11	11,20	5	009000704



900PH/SB4
PH1-PH2-PH3-PH4
54,50 € 1 009000708

900MC/PH

Schraubendrehereinsätze
für Phillips®-Schrauben, farbig



PH	Ø mm	L mm	L1 mm	€	U	IT
1	12	28	12	16,80	3	009002701
2	12	28	12	16,80	3	009002702
3	12	28	12	16,80	3	009002703

900PZ

Schraubendrehereinsätze
für Pozidriv®-Supadriv®-Schrauben



PZ	Ø mm	L mm	€	U	IT
1	12	28	11,90	3	009000711
2	12	28	11,90	3	009000712
3	12	28	11,90	3	009000713

900ME

Sechskant-Steckschlüssel



mm	Ø mm	L mm	L1 mm	€	U	IT
2,5	12	25	4,5	9,70	5	009000502
3	12	25	5,0	9,70	5	009000503
4	12	25	5,6	9,70	5	009000504
5	12	25	6,3	9,70	5	009000505
6	12	25	7,6	9,70	5	009000506
7	13	25	7,2	9,70	5	009000507
8	13	25	8,0	9,70	5	009000508
10	13	25	8,7	12,10	5	009000510



900ME/SB8
2,5-3-4-5-6-7-8-10 mm
94,50 € 1 009000518

900PE/AS

Sechskant-Steckschlüssel



"	Ø mm	L mm	€	U	IT
1/8	11,9	25	22,10	5	009000521
5/32	11,9	25	22,10	5	009000522
3/16	11,9	25	22,10	5	009000523
7/32	11,9	25	22,10	5	009000524
1/4	11,9	25	22,10	5	009000525
9/32	13,1	25	22,10	5	009000526
5/16	13,1	25	22,10	5	009000527

900PT

Schraubendrehereinsätze
für 5-spitzige Schrauben



PT	Ø mm	L mm	L1 mm	€	U	IT
PT10	12	28	12	20,60	5	009000750
PT15	12	28	12	20,60	5	009000755
PT20	12	28	12	20,60	5	009000760
PT25	12	28	12	20,60	5	009000765
PT27	12	28	12	20,60	5	009000767
PT30	12	28	12	20,60	5	009000770

900TX

Steckschlüssel
für Torx®-Schrauben

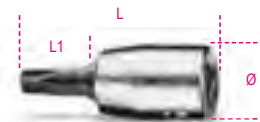

T	Ø mm	L mm	L1 mm	€	U	IT
T6	12	28	12	15,00	5	009000717
T7	12	28	12	15,00	5	009000718
T8	12	28	12	15,10	5	009000719
T9	12	28	12	15,10	5	009000720
T10	12	28	12	15,10	5	009000721
T15	12	28	12	15,10	5	009000722
T20	12	28	12	15,10	5	009000723
T25	12	28	12	15,10	5	009000724
T27	12	28	12	15,10	5	009000725
T30	12	28	12	15,10	5	009000726
T40	12	28	12	15,10	5	009000727



900TX/SB8
T9-T10-T15-T20
T25-T27-T30-T40
135,00 € 1 009000730

900MC/TX

Steckschlüssel
für Torx®-Schrauben, farbig

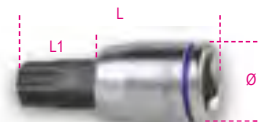

T	Ø mm	L mm	L1 mm	€	U	IT
T10	12	28	12	17,40	3	009002721
T15	12	28	12	17,40	3	009002722
T20	12	28	12	17,40	3	009002723
T25	12	28	12	17,40	3	009002724
T27	12	28	12	17,40	3	009002725
T30	12	28	12	17,40	3	009002726
T40	12	28	12	17,40	3	009002727

900/16

Verbindungsstück, Innenvierkant 1/4",
Außenvierkant 3/8"



UNI/ISO 3316 DIN 3123

L mm	Ø mm	□	■	€	U	IT
28	13,0	1/4	3/8	7,90	5	009000814

900/...
Verlängerungen,
Innen- und Außenvierkant 1/4"

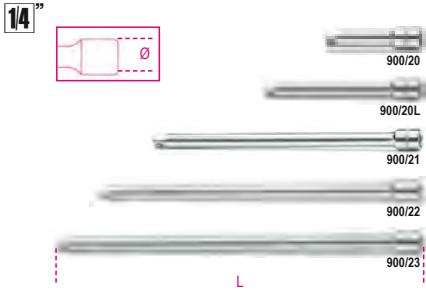

UNI/ISO 3316 DIN 3123

	L mm	Ø mm	€	5	009000824
900/20	50	11,5	10,00	5	009000818
900/20L	100	11,5	10,30	5	009000819
900/21	150	11,5	10,80	5	009000822
900/22	250	11,5	15,70	5	009000823
900/23	350	11,5	18,90	5	009000824

900AN
Verlängerungen, schwenkbar,
Innen- und Außenvierkant 1/4"

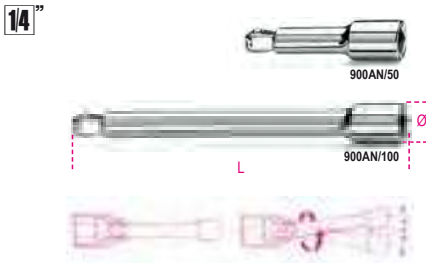

	L mm	Ø mm	€	3	009000825
900AN/50	50	11,5	10,90	3	009000825
900AN/100	100	11,5	12,00	3	009000826

900FL
Flexible Verlängerung,
Innen- und Außenvierkant 1/4"



	L mm	Ø mm	€	3	009000828
900FL	150	12	15,90	3	009000828

900/25
Kardangelen,
Innen- und Außenvierkant 1/4"



UNI/ISO 3316 DIN 3123

	L mm	Ø mm	€	5	009000830
900/25	41	12,5	19,40	5	009000830

900BG/30C
Steckgriff, Außenvierkant 1/4"



UNI/ISO 3315 DIN 3122

	L mm	L1 mm	€	5	009000833
900BG/30C	128	20	9,60	5	009000833

900BG/30
Steckgriff, Außenvierkant 1/4"



UNI/ISO 3315 DIN 3122

	L mm	L1 mm	€	5	009000834
900BG/30	176	68	10,00	5	009000834

900/32
Flexibler Steckgriff, Außenvierkant 1/4"



	L mm	L1 mm	€	2	009000839
900/32	280	154	23,00	2	009000839

900/35A
Gelenkgriff, Außenvierkant 1/4"

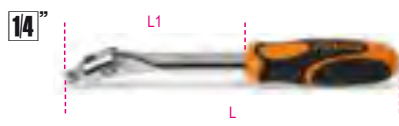

UNI/ISO 3315 DIN 3122

	L mm	L1 mm	€	5	009000840
900/35A	148	84	32,50	5	009000840

900M/35
Metallgelenkgriff, Außenvierkant 1/4"



UNI/ISO 3315
DIN 3122

	L mm	€	3	009000845
900M/35	130	42,00	3	009000845



900/40
Verlängerung mit Kardangelen,
Außenvierkant 1/4"



	L mm	L1 mm	€	3	009000843
900/40	390	145	44,00	3	009000843

900/42
Gleitgriff, Außenvierkant 1/4"

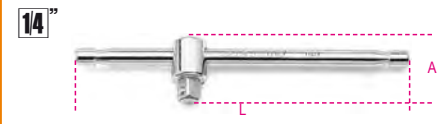

UNI/ISO 3315 DIN 3122

	L mm	A mm	€	5	009000854
900/42	115	22	11,00	5	009000854

900T/44
Steckgriff, Außenvierkant 1/4"



	L mm	L1 mm	€	2	009000860
900T/44	238	105	16,60	2	009000860

900/55
Umschaltknarre
mit Außenvierkant Antrieb 1/4",
48zahnig



UNI/ISO 3315 DIN 3122

	L mm	Ø mm	A mm	€	5	009000870
900/55	125	25	29	52,50	5	009000870

900/55Z

72

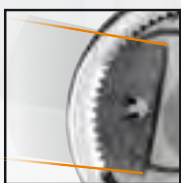

Die Umschaltknarre 900/55Z wurde von dem Technischen Büro Beta mit einem neuen 72-zahnigen Antrieb, von denen 15 immer in Aufnahme sind, entwickelt. Die Arbeitslast wird daher auf einer großen Zahnanzahl unterteilt, so dass der Verschleiß des einzelnen Elements verringert und eine sehr lange Nutzdauer geboten wird.



Die 72 Zähne garantieren außerdem einen Aufnahmewinkel von nur 5° und einen sehr kompakten Kopf, um auch auf sehr engem Raum schnell zu arbeiten.

Der ergonomische Bimaterial-Griff Beta ermöglicht die Verwendung der Knarre sowohl in schneller Weise als auch mit höherer Kraft.

900/55Z

Umschaltknarre mit Außenvierkanttrieb 1/4", 72-Zähne-Mechanismus

72

1/4"

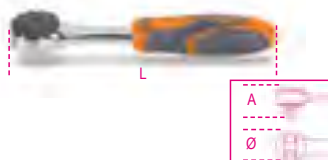

L	Ø	A	€	U	W
mm	mm	mm			
126	25	23	52,50	3	009000882

900M/55

Umschaltknarre, Außenvierkant 1/4", mit Metallgriff

1/4"



L	Ø	A	€	U	W
mm	mm	mm			
110	22	18	67,00	3	009000905

Für die Ersatzdrehvorrichtungen der Knarren, s. Details nach Artikel 929/C8

900/58

Umschaltknarre mit Außenvierkanttrieb 1/4", Drehgriff, 52zahnig

- Anwendungssystem mit Drehgriff
- Buchsen-Auswurf-Taste
- Umschaltsystem am Kopf der Knarre
- Bimaterial-Griff

1/4"

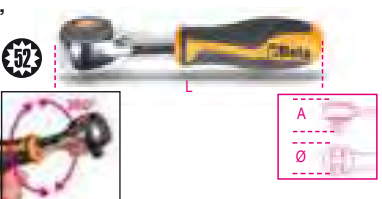

L	Ø	A	€	U	W
mm	mm	mm			
126	28	28,5	80,00	2	009000884

900/C39N

11 Sechskant-Steckschlüssel, 21 Schraubeinsätze und 7 Betätigungswerkzeuge

1/4"

1/4"



900/C39N	€	U	W
	237,00	1	009000947

861LP	0,6x4,5 - 1,2x6,5 - 1,2x8 mm
861PH	PH1-PH2-PH3
861PZ	PZ1-PZ2-PZ3
861PE	2,5-3-4-5-6 mm
861RTX	T10-T15-T20-T25-T27-T30-T40
900	5-5,5-6-7-8-9-10-11-12-13-14 mm
900/20	50 mm
900/20L	100 mm
900/25	
900BG/30C	128 mm
892/0	
895/1	
900/55Z	126 mm

900/C39U

11 Multiprofil-Steckschlüssel, 21 Schraubeinsätze und 7 Betätigungswerkzeuge

1/4"

1/4"



900/C39U	€	U	W
	239,00	1	009001947

861LP	0,6x4,5 - 1,2x6,5 - 1,2x8 mm
861PH	PH1-PH2-PH3
861PZ	PZ1-PZ2-PZ3
861PE	2,5-3-4-5-6 mm
861RTX	T10-T15-T20-T25-T27-T30-T40
900U	5-5,5-6-7-8-9-10-11-12-13-14 mm * 3/16-13/64-7/32-1/4-9/32-5/16 11/32-3/8-7/16-15/32-1/2-9/16 E6-E7-E8-E10-E12-E14-E16-E18 M6-M8-M10-M12-M14-M16-M18
900/20	50 mm
900/20L	100 mm
900/25	
900BG/30C	128 mm
892/0	
895/1	
900/55Z	126 mm

900/C11

11 Sechskant-Steckschlüssel, 20 Schraubeinsätze und 8 Betätigungswerkzeuge

1/4"

1/4"



900/C11	€	U	W
	257,00	1	009000971

861LP	0,5x3 - 0,8x5,5 1x5,5 - 1,2x6,5 mm
861PE	3 - 4 - 5 - 6 - 8 mm
861PH	0 - 1 - 2 - 3
861TX	T8 - T10 - T15 - T20 T25 - T30 - T40
895/1	
900	5 - 5,5 - 6 - 7 - 8 - 9 - 10 11 - 12 - 13 - 14 mm □ 1/4 - ■ 3/8
900/16	
900/20	50 mm
900/21	150 mm
900/25	
900BG/30	176 mm
900/42	
900/55	

270x120x45 mm - 1,2 kg

9899 900C11	€	U	W
Thermoformateinsatz, leer	15,60	1	098990132

900/C11Z

11 Sechskant-Steckschlüssel,
20 Schraubeinsätze und 8
Betätigungswerkzeuge

1/4"

1/4"



900/C11Z € 257,00 1 009000984

	861LP	0,5x3 - 0,8x5,5 - 1x5,5 - 1,2x6,5 mm
	861PE	3 - 4 - 5 - 6 - 8 mm
	861PH	0 - 1 - 2 - 3
	861TX	T8 - T10 - T15 - T20 T25 - T30 - T40
	895/1	
	900	5 - 5,5 - 6 - 7 - 8 - 9 - 10 11 - 12 - 13 - 14 mm
	900/16	□ 1/4 - ■ 3/8
	900/20	50 mm
	900/21	150 mm
	900/25	
	900BG/30	176 mm
	900/42	
	900/55Z	

≡ 350x150x50 mm - 1,2 kg

9899 900/C11 € 15,60 1 098990132
Thermoformateinsatz, leer

900/C12MR

12 Sechskant-Steckschlüssel,
20 Schraubeinsätze und 7
Betätigungswerkzeuge
im Blechkasten mit Schaumeinsatz

1/4"

1/4"



900/C12MR € 287,00 1 009000962

	900	4-5-5,5-6-7-8-9-10-11-12-13-14 mm
	900/20	50 mm
	900/21	150 mm
	900/25	
	900/42	115 mm
	900BG/30	128 mm
	900/58	
	895/1	
	861TX	T8-T10-T15-T20-T25-T30-T40
	861PH	PH0-PH1-PH2-PH3
	861LP	0,5-0,8-1-1,2 mm
	861PE	3-4-5-6-8 mm

≡ 350x150x50 mm 1,3 kg



900/C12MZ

12 Sechskant-Steckschlüssel,
20 Schraubeinsätze und 7
Betätigungswerkzeuge
im Schaumeinsatz

1/4"

1/4"



900/C12MZ € 260,00 1 009000983

	900	4-5-5,5-6-7-8-9-10-11-12-13-14 mm
	900/20	50 mm
	900/21	150 mm
	900/25	
	900/42	115 mm
	900BG/30	176 mm
	900/55Z	
	895/1	
	861TX	T8-T10-T15-T20-T25-T30-T40
	861PH	PH0-PH1-PH2-PH3
	861LP	0,5x3 - 0,8x5,5 - 1x5,5 - 1,2x6,5 mm
	861PE	3-4-5-6-8 mm

≡ 350x150x50 mm - 1,2 kg

900/C13-5

13 Sechskant-Steckschlüssel
und 5 Betätigungswerkzeuge

1/4"



900/C13-5 € 209,00 1 009000953

	900	4 - 4,5 - 5 - 5,5 - 6 - 7 - 8 - 9 10 - 11 - 12 - 13 - 14 mm
	900/21	150 mm
	900/25	
	900BG/30	
	900/42	
	900/55	

≡ 270x120x45 mm - 1 kg

9899 900/C13-5 € 15,60 1 098990131
Thermoformateinsatz, leer

900/C13-8

13 Sechskant-Steckschlüssel
und 8 Betätigungswerkzeuge

1/4"



900/C13-8 € 253,00 1 009000954

	900	4 - 4,5 - 5 - 5,5 - 6 - 7 - 8 - 9 10 - 11 - 12 - 13 - 14 mm
	900/16	□ 1/4 - ■ 3/8
	900/20	50 mm
	900/21	150 mm
	900/25	
	900BG/30	
	900/35A	
	900/42	
	900/55	

≡ 270x120x45 mm - 1,1 kg

900MB/C19

11 Zwölfkant-Steckschlüssel
und 8 Betätigungswerkzeuge

1/4"



900MB/C19 € 293,00 1 009000977

	900MB	5 - 5,5 - 6 - 7 - 8 - 9 - 10 - 11 12 - 13 - 14 mm
	900/16	□ 1/4 - ■ 3/8
	900/20	50 mm
	900/21	150 mm
	900/25	
	900BG/30	
	900/35A	
	900/42	
	900/55	

≡ 270x120x45 mm - 1,1 kg



900/C24

13 Sechskant-Steckschlüssel,
11 Schraubendrehereinsätze
und 6 Betätigungswerkzeuge

1/4"



900/C24 € 324,00 1 009000956

- 900 4 - 4,5 - 5 - 5,5 - 6 - 7 - 8 - 9
10 - 11 - 12 - 13 - 14 mm
 - 900LP 0,8x4 - 1,2x6,5 - 1,2x8 mm
 - ⊕ 900PH PH1 - PH2 - PH3
 - 900ME 3 - 4 - 5 - 6 - 8 mm
 - 900/20 50 mm
 - 900/21 150 mm
 - 900/25
 - 900BG/30
 - 900/42
 - ⊕ 900/55
- ≡ 270x120x45 mm - 1,1 kg

900MB/C28

11 Zwölfkant-Steckschlüssel,
11 Schraubendrehereinsätze
und 6 Betätigungswerkzeuge

1/4"



900MB/C28 € 365,00 1 009000979

- 900MB 5 - 5,5 - 6 - 7 - 8 - 9 - 10 - 11
12 - 13 - 14 mm
 - 900LP 0,8x4 - 1,2x6,5 - 1,2x8 mm
 - ⊕ 900PH PH1 - PH2 - PH3
 - 900ME 3 - 4 - 5 - 6 - 8 mm
 - 900/20 50 mm
 - 900/21 150 mm
 - 900/25
 - 900BG/30
 - 900/42
 - ⊕ 900/55
- ≡ 270x120x45 mm - 1,1 kg

900MC/C24

11 Sechskant-Steckschlüssel,
13 Schraubendrehereinsätze, farbig, und 6
Betätigungswerkzeuge

1/4"



900MC/C24 € 426,00 1 009002960

- 900MC 4 - 5 - 6 - 7 - 8 - 9
10 - 11 - 12 - 13 - 14 mm
 - ⊕ 900MC/PH PH1 - PH2 - PH3
 - ⊕ 900MC/TX T10 - T15 - T20 - T25 - T27 - T30
- T40
 - 900MC/LP 0,8x4 - 1,2x6,5 - 1,2x8 mm
 - 900/20 50 mm
 - 900/21 150 mm
 - 900/25
 - 900BG/30
 - 900/42
 - ⊕ 900/55
- ≡ 270x120x45 mm - 1,1 kg

900MC/C32

11 Sechskant-Steckschlüssel, farbig, 20
Schraubeinsätze, farbig, und 7
Betätigungswerkzeuge

1/4"



900MC/C32 € 269,00 1 009002963

- 900MC 4 - 5 - 6 - 7 - 8 - 9 - 10 - 11 - 12 - 13
- 14 mm
 - 860LP 0,5x3 - 0,8x5,5 -
1,0x5,5 - 1,2x6,5 mm
 - ⊕ 860PH 0 - 1 - 2 - 3
 - 860PE 3 - 4 - 5 - 6 - 8 mm
 - ⊕ 860TX T8 - T10 - T15 - T20 - T25 - T30 - T40
 - 895/1
 - 900/20
 - 900/21
 - 900/25
 - 900BG/30
 - 900/42
 - ⊕ 900/55
- ≡ 270x120x45 mm - 1,2 kg

900U/C12M

12 Multiprofil-Steckschlüssel,
20 Schraubeinsätze und 7
Betätigungswerkzeuge,
im Schaumstoffeinsatz

1/4"

1/4"



900U/C12M € 263,00 1 009001792

- 900U ○ 4-5-5,5-6-7-8-9-10-11-12-13-14 mm
" 5/32-3/16-13/64-7/32-1/4-9/32-5/16
11/32-3/8-7/16-15/32-1/2-9/16
 - E5-E6-E7-E8-E10-E12-E14-E16-E18
○ M5-M6-M8-M10-M12-M14-M16-M18
 - 900/20 50 mm
 - 900/21 150 mm
 - 900/25
 - 900/42 115 mm
 - 900BG/30 176 mm
 - ⊕ 900/55 125 mm
 - 895/1 ○ 1/4 - □ 1/4
 - 861LP 0,5x3 - 0,8x5,5 - 1,0x5,5 - 1,2x6,5 mm
 - 861PE 3-4-5-6-8 mm
 - ⊕ 861PH PH0-PH1-PH2-PH3
 - ⊕ 861TX T8-T10-T15-T20-T25-T30-T40
- ≡ 350x150x50 mm - 1,2 kg



900AS/C10 - /MB-C17

10 Sechskant-Steckschlüssel
und 7 Betätigungswerkzeuge

14"



900AS/C10 € 236,00 1 009000961

○ 900AS	3/16 - 7/32 - 1/4 - 9/32 - 5/16 11/32 - 3/8 - 7/16 - 1/2 - 9/16
900/20	50 mm
900/21	150 mm
900/25	
900BG/30	
900/35A	
900/42	
900/55	

270x120x45 mm - 1,1 kg

900AS/MB-C17 € 280,00 1 009000981

○ 900AS/MB	3/16 - 7/32 - 1/4 - 9/32 - 5/16 11/32 - 3/8 - 7/16 - 1/2 - 9/16
900/20	50 mm
900/21	150 mm
900/25	
900BG/30	
900/35A	
900/42	
900/55	

270x120x45 mm - 1,1 kg

900AS/C17-MBM

10 Zwölfkant-Steckschlüssel
und 7 Betätigungswerkzeuge
für Flugzeugwartung

14"



900AS/C17-MBM € 304,00 1 009000982

○ 900AS/MB	3/16 - 7/32 - 1/4 - 9/32 - 5/16 11/32 - 3/8 - 7/16 - 1/2 - 9/16
900/20	50 mm
900/21	150 mm
900/25	
900BG/30	
900M/35	
900/42	
900M/55	

270x120x45 mm - 1,2 kg

900/C11HR

11 Sechskant-Steckschlüssel,
20 Schraubeinsätze und 7
Betätigungswerkzeuge
im festen Thermoformateinsatz,
im Blechkasten
• Knarre mit Drehgriff

14"

14"



900/C11HR € 285,00 1 009000980

● 861LP	0,5x3-0,8x5,5-1x5,5-1,2x6,5 mm
⊕ 861PH	PH0-PH1-PH2-PH3
○ 861PE	3-4-5-6-8 mm
⊗ 861TX	T8-T10-T15-T20-T25-T30-T40
895/1	
○ 900	5-5,5-6-7-8-9-10-11-12-13-14 mm
900/16	□ 1/4 - ■ 3/8
900/20	50 mm
900/21	150 mm
900/25	
900/42	
900BG/30	
900/58	

350x150x50 mm - 1,3 kg

902R/C6

6 Adapter für Steckschlüssel



902R/C6 € 126,00 1 009020814

900/16	□ 1/4 - ■ 3/8
910/15	□ 3/8 - ■ 1/4
910/16	□ 3/8 - ■ 1/2
920/15	□ 1/2 - ■ 3/8
920/16	□ 1/2 - ■ 3/4
928/15	□ 3/4 - ■ 1/2

170x100x35 mm - 600 g

902A/C22

22 Sechskant-Steckschlüsseln und 6
Betätigungswerkzeugen
im Blechkasten

14"

12"



902A/C22 € 409,00 1 009020807

○ 900	5-5,5-6-7-8-9-10-11-12-13 mm
900/20	50 mm
900/25	
14 900/55	
○ 920A	10-13-14-15-17-18-19 22-24-27-30-32 mm
920/21	125 mm
920/25	
12 920/55	

420x185x60 mm - 3,5 kg

9899 902A/C22 € 15,60 1 098990133

Thermoformateinsatz, leer

910A

Sechskant-Steckschlüssel



UNI/ISO 2725 DIN 3124

mm	Ø	L	Ø1	€		
6	9,5	28	16,7	7,30	5	009100006
7	10,7	28	16,7	7,30	5	009100007
8	12,1	28	16,7	7,30	5	009100008
9	13,2	28	16,7	7,30	5	009100009
10	14,6	29	16,7	7,30	5	009100010
11	15,8	29	16,7	7,30	5	009100011
12	17,2	30	17,7	7,50	5	009100012
13	18,4	31	17,0	7,50	5	009100013
14	19,7	32	17,5	7,50	5	009100014
15	20,9	32	18,0	7,50	5	009100015
16	22,2	33	18,5	8,40	5	009100016
17	23,2	33	19,0	8,40	5	009100017
18	24,7	34	20,0	8,40	5	009100018
19	25,8	35	21,0	8,40	5	009100019
20	27,2	35	22,0	8,90	5	009100020
21	28,2	36	23,0	8,90	5	009100021
22	29,7	37	24,0	9,20	5	009100022



910A/SB17 € 160,00 1 009100030

6-7-8-9-10-11-12
13-14-15-16-17
18-19-20-21-22 mm

910B Zwölfkant-Steckschlüssel

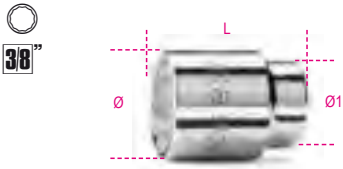

UNI/ISO 2725 DIN 3124

mm	Ø	L	Ø1	€	U	IT
6	9,5	28	16,7	7,30	5	009100106
7	10,7	28	16,7	7,30	5	009100107
8	12,1	28	16,7	7,30	5	009100108
9	13,2	28	16,7	7,30	5	009100109
10	14,6	29	16,7	7,30	5	009100110
11	15,8	29	16,7	7,30	5	009100111
12	17,2	30	17,7	7,50	5	009100112
13	18,4	31	17,0	7,50	5	009100113
14	19,7	32	17,5	7,50	5	009100114
15	20,9	32	18,0	7,50	5	009100115
16	22,2	33	18,5	8,40	5	009100116
17	23,2	33	19,0	8,40	5	009100117
18	24,7	34	20,0	8,40	5	009100118
19	25,8	35	21,0	8,40	5	009100119
20	27,2	35	22,0	8,90	5	009100120
21	28,2	36	23,0	8,90	5	009100121
22	29,7	37	24,0	9,20	5	009100122



910B/SB17	€	U	IT
6-7-8-9-10-11-12 13-14-15-16-17 18-19-20-21-22 mm	160,00	1	009100130

910AL Sechskant-Steckschlüssel, lange Ausführung



UNI/ISO 2725 DIN 3124

mm	Ø	L	Ø1	€	U	IT
8	12,0	55	17	15,40	3	009100158
9	13,0	55	17	15,40	3	009100159
10	14,5	55	17	15,40	3	009100160
11	16,0	55	17	15,40	3	009100161
12	17,0	55	17	15,40	3	009100162
13	18,0	55	17	16,80	3	009100163
14	20,0	55	18	16,80	3	009100164
15	21,0	55	20	16,80	3	009100165
16	22,0	55	20	16,80	3	009100166
17	23,5	55	22	16,80	3	009100167
18	24,5	55	23	18,30	2	009100168
19	25,0	55	24	18,30	2	009100169
21	27,0	65	26	19,70	2	009100171
22	29,0	65	28	19,70	2	009100172



910AL/SB14	€	U	IT
8-9-10-11-12-13-14 15-16-17-18-19-21-22 mm	259,00	1	009100174

910BL Zwölfkant-Steckschlüssel, lange Ausführung



UNI/ISO 2725 DIN 3124

mm	Ø	L	Ø1	€	U	IT
8	12,0	55	17	15,40	3	009100308
9	13,0	55	17	15,40	3	009100309
10	14,5	55	17	15,40	3	009100310
11	16,0	55	17	15,40	3	009100311
12	17,0	55	17	15,40	3	009100312
13	18,0	55	17	16,80	3	009100313
14	20,0	55	18	16,80	3	009100314
15	21,0	55	20	16,80	3	009100315
16	22,0	55	20	16,80	3	009100316
17	23,5	55	22	16,80	3	009100317
18	24,5	55	23	18,30	2	009100318
19	25,0	55	24	18,30	2	009100319
21	27,0	65	26	19,70	2	009100321
22	29,0	65	28	19,70	2	009100322

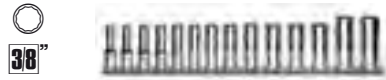

910BL/SB14	€	U	IT
8-9-10-11-12-13 14-15-16-17-18 19-21-22 mm	259,00	1	009100340

910B/SN Zwölfkant-Gelenksteckschlüssel

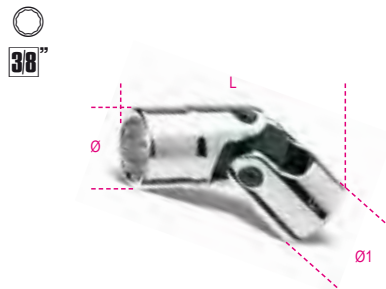

mm	Ø	L	Ø1	€	U	IT
10	14,5	48,5	19	39,50	2	009100230
11	15,8	49,5	19	39,50	2	009100231
12	17,0	50,0	19	39,50	2	009100232
13	18,3	51,0	19	39,50	2	009100233
14	19,5	51,0	19	44,00	2	009100234
15	20,8	53,5	19	44,00	2	009100235
16	22,0	53,5	19	44,00	2	009100236
17	23,3	54,5	19	44,00	2	009100237
18	24,5	54,5	19	44,00	2	009100238
19	25,8	56,5	19	44,00	2	009100239

910A/AS Sechskant-Steckschlüssel



"	Ø	L	Ø1	€	U	IT
1/4	10,3	26	17,3	8,60	5	009100276
5/16	11,9	26	17,3	8,60	5	009100278
11/32	13,3	26	17,3	8,60	5	009100279
3/8	13,9	26	17,3	8,60	5	009100280
7/16	15,8	26	17,3	8,60	5	009100281
1/2	17,9	26	17,3	8,80	5	009100283
9/16	19,5	27	18,5	8,80	5	009100284
19/32	20,6	27	19,5	8,80	5	009100285
5/8	21,9	28	20,0	9,50	5	009100286
11/16	24,6	30	22,5	9,50	5	009100287
3/4	25,9	30	23,5	9,50	5	009100289
13/16	27,9	32	26,0	10,80	5	009100291
7/8	29,6	32	26,5	11,10	5	009100292



910A-AS/SB13	€	U	IT
1/4-5/16-11/32-3/8-7/16 1/2-9/16-19/32-5/8-11/16 3/4-13/16-7/8	141,00	1	009100295

910AS Zwölfkant-Steckschlüssel

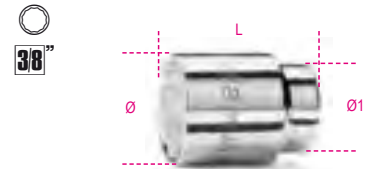

"	Ø	L	Ø1	€	U	IT
1/4	9,5	28	16,7	8,60	5	009100201
5/16	12,1	28	16,7	8,60	5	009100202
11/32	13,2	28	16,7	8,60	5	009100203
3/8	14,6	29	16,7	8,60	5	009100204
7/16	15,8	29	16,7	8,60	5	009100205
1/2	18,4	31	17,0	8,80	5	009100206
9/16	19,7	32	17,5	8,80	5	009100207
19/32	20,9	32	18,0	8,80	5	009100208
5/8	22,2	33	18,5	9,50	5	009100209
11/16	24,7	34	20,0	9,50	5	009100210
3/4	25,8	35	21,0	9,50	5	009100211
13/16	28,2	36	23,0	10,80	5	009100212
7/8	29,7	37	24,0	11,10	5	009100213



910AS/SB13	€	U	IT
1/4-5/16-11/32-3/8-7/16 1/2-9/16-19/32-5/8-11/16 3/4-13/16-7/8	141,00	1	009100215

910AS/L

Zwölfkant-Steckschlüssel,
lange Ausführung

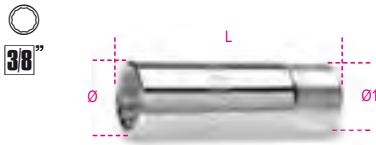

"	Ø mm	L mm	Ø1 mm	€	Hand	Computer
1/4	10	55	17	19,30	3	009100350
5/16	12	55	17	19,30	3	009100351
3/8	14	55	17	19,30	3	009100352
7/16	16	55	17	19,30	3	009100353
1/2	18	55	17	21,50	3	009100354
9/16	20	55	18	21,50	3	009100355
19/32	21	55	20	22,10	3	009100356
5/8	22	55	20	22,10	3	009100357
11/16	23	55	22	22,10	3	009100359
3/4	25	55	24	23,50	3	009100360
13/16	27	65	26	27,50	3	009100362
7/8	29	65	28	27,50	3	009100363



910ASL/SB12	€	Hand	Computer
1/4-5/16-3/8-7/16	285,00	1	009100365
1/2-9/16-19/32-5/8-11/16			
3/4-13/16-7/8			

910AS/SN

Zwölfkant-Gelenksteckschlüssel

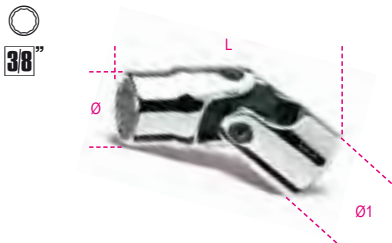

* SAE AS 954E

"	Ø mm	L mm	Ø1 mm	€	Hand	Computer
* 3/8	14,0	48,0	19	43,50	2	009100260
* 7/16	15,8	51,0	19	43,50	2	009100261
* 1/2	18,3	51,0	19	43,50	2	009100262
* 9/16	19,5	51,0	19	44,00	2	009100263
* 5/8	22,0	53,5	19	44,00	2	009100264
11/16	24,5	54,5	19	47,00	2	009100265
3/4	25,8	56,5	19	47,00	2	009100266

910FTX

Steckschlüssel für Torx®-Schrauben



"	Ø mm	L mm	Ø1 mm	€	Hand	Computer
E4	6,2	26	17,3	10,30	5	009100404
E5	7,0	26	17,3	10,30	5	009100405
E6	8,3	26	17,3	10,30	5	009100406
E7	8,9	26	17,3	10,30	5	009100407
E8	9,9	26	17,3	10,30	5	009100408
E10	12,0	26	17,3	10,30	5	009100410
E11	13,3	26	17,3	10,30	5	009100411
E12	14,5	26	17,3	10,30	5	009100412
E14	15,8	26	17,3	10,30	5	009100414
E16	18,0	26	17,3	10,30	5	009100416
E18	19,5	26	18,5	11,40	3	009100418
E20	21,9	26	20,0	11,40	3	009100420



910FTX/SB9	€	Hand	Computer
E4-E5-E6-E7-E8	108,00	1	009100430
E10-E12-14-E16			

910FTX/L

Steckschlüssel für Torx®-Schrauben,
lange Ausführung



"	Ø mm	L mm	Ø1 mm	€	Hand	Computer
E4	6,2	55	17,3	23,20	3	009100440
E5	7,0	55	17,3	23,20	3	009100441
E6	8,3	55	17,3	23,20	3	009100442
E7	8,9	55	17,3	23,20	3	009100443
E8	9,9	55	17,3	23,20	3	009100444
E10	12,0	55	17,3	23,20	3	009100445



910FTX-L/SB6	€	Hand	Computer
E4-E5-E6	151,00	1	009100449
E7-E8-E10			

910FTX/XL

Steckschlüssel für Torx®-Schrauben,
extralange Ausführung

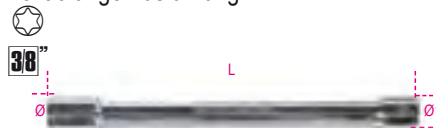

"	Ø mm	L mm	Ø1 mm	€	Hand	Computer
E6	8,0	200	18	20,80	2	009100766
E7	8,0	200	18	20,80	2	009100767
E8	10,0	200	18	20,80	2	009100768
E10	14,0	200	18	20,80	2	009100770
E11	14,0	200	18	20,80	2	009100771
E12	14,0	200	18	20,80	2	009100772

"	Ø mm	L mm	Ø1 mm	€	Hand	Computer
E14	17,0	200	18	22,70	2	009100774
E16	18,6	200	18	22,70	2	009100776
E18	21,5	200	18	24,00	2	009100778
E20	21,5	200	18	24,00	2	009100780

910FTX-XL/C10

Sortiment aus 10 Steckschlüsseln für
Torx®-Schrauben, lange Ausführung,
im Kunststoffkasten



910FTX-XL-C10	€	Hand	Computer
E6-E7-E8-E10-E11- E12-E14-E16-E18-E20	218,00	1	009100976

255x195x62 mm - 2,3 kg

910LP

Schraubendrehereinsätze
für Schlitzschrauben

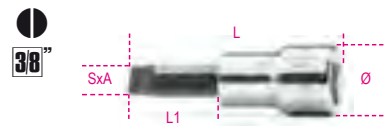

SxA mm	Ø mm	L mm	L1 mm	€	Hand	Computer
1x5,5	18,5	54	24	18,00	2	009100452
1,2x6,5	18,5	54	24	18,00	2	009100453
1,2x8	18,5	54	24	18,00	2	009100454
1,6x9	18,5	54	24	18,00	2	009100456

910PH

Schraubendrehereinsätze
für Phillips®-Schrauben

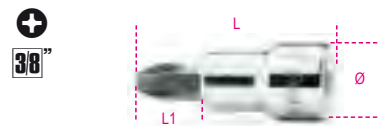

PH	Ø mm	L mm	L1 mm	€	Hand	Computer
1	18,5	48	18	16,90	2	009100471
2	18,5	48	18	16,90	2	009100472
3	18,5	48	18	16,90	2	009100473
4	18,5	48	18	16,90	2	009100474



910PH/SB4	€	Hand	Computer
PH1-PH2-PH3-PH4	77,00	1	009100478

910PE Sechskant-Steckschlüssel



DIN 7422

mm	Ø mm	L mm	L1 mm	€	U	PC
3	18,5	50	20	14,80	5	009100490
4	18,5	50	20	14,80	5	009100492
5	18,5	50	20	14,80	5	009100494
6	18,5	50	20	14,80	5	009100496
7	18,5	50	20	14,80	5	009100497
8	18,5	50	20	14,80	5	009100498
9	18,5	50	20	14,80	5	009100499
10	18,5	50	20	14,80	5	009100500



910PE/SB7
3-4-5-6-7-8-10 mm € 117,00 1 009100503

910BP Sechskant-Steckschlüssel mit kugelförmigem Kopf



mm	L mm	L1 mm	€	U	PC
4L	92	62	17,60	3	009100584
5L	92	62	17,60	3	009100585
6L	92	62	17,60	3	009100586
7L	92	62	17,60	3	009100587
8L	92	62	17,60	3	009100588
10L	132	102	19,00	3	009100590



910BP/SB6L
4L-5L-6L-7L-8L-10L mm € 119,00 1 009100596

910ME Sechskant-Steckschlüssel



mm	Ø mm	L mm	L1 mm	€	U	PC
4	18	62	15	17,70	5	009100504
5	18	62	15	17,70	5	009100505
6	18	62	15	17,70	5	009100506
7	18	62	15	17,90	5	009100507
8	19	62	15	17,90	5	009100508
10	20	62	15	17,90	5	009100510
12	20	62	15	17,90	5	009100512



910ME/SB5
4-5-6-8-10 mm € 99,50 1 009100515

910PE/AS Sechskant-Steckschlüssel



"	Ø mm	L mm	L1 mm	€	U	PC
1/8	18,5	50	20	25,50	2	009100531
5/32	18,5	50	20	25,50	2	009100532
3/16	18,5	50	20	25,50	2	009100533
7/32	18,5	50	20	25,50	2	009100534
1/4	18,5	50	20	25,50	2	009100535
5/16	18,5	50	20	25,50	2	009100536
3/8	18,5	50	20	28,00	2	009100537

910PT Schraubendrehereinsätze für 5-spitzige Schrauben



"	Ø mm	L mm	L1 mm	€	U	PC
PT40	20	50	20	23,50	3	009100540
PT45	20	50	20	24,00	3	009100545
PT50	20	50	20	28,50	3	009100550



910PT/SB8
PT10-PT15-PT20-PT25
PT30-PT40-PT45-PT50 € 194,00 1 009100558

910TX Steckschlüssel, für Torx®-Schrauben



"	Ø mm	L mm	L1 mm	€	U	PC
T15	18,5	50	20	19,30	5	009100519
T20	18,5	50	20	19,30	5	009100520
T25	18,5	50	20	19,30	5	009100521
T27	18,5	50	20	19,30	5	009100522
T30	18,5	50	20	19,30	5	009100523
T40	18,5	50	20	19,30	5	009100524
T45	18,5	50	20	19,30	3	009100525
T50	18,5	50	20	19,30	3	009100526



910TX/SB6
T15-T20-T25
T27-T30-T40 € 128,00 1 009100530

910XZN Steckschlüssel für Vielzahnschrauben (XZN®)



"	L mm	€	U	PC
M4	50	20,80	3	009100559
M5	50	20,80	3	009100560
M6	50	20,80	3	009100561
M8	50	20,80	3	009100563
M10	50	22,10	3	009100565

910CF Crowfoot-Schlüssel mit Innenvierkanttrieb 3/8"



"	A mm	L mm	€	U	PC
10	21,3	32,3	12,60	2	009100135
11	23,1	34,3	12,60	2	009100136
12	25,5	36,2	14,10	2	009100137
13	26,9	37,4	14,10	2	009100138
14	30,2	40,0	15,00	2	009100139
15	33,3	41,3	15,60	2	009100140
16	33,3	41,3	17,00	2	009100141
17	38,1	46,5	19,70	2	009100142
18	38,1	46,5	19,70	2	009100143
19	39,6	48,0	21,50	2	009100144



910CF/SB10
10-11-12-13-14-15
16-17-18-19 mm € 179,00 1 009100147

910/15 Reduzierstück, Innenvierkant 3/8", Außenvierkant 1/4"



UNI/ISO 3316 DIN 3123

L mm	Ø mm	□	■	€	U	PC
30	17,0	3/8	1/4	10,90	5	009100810



Die Torsionslast muss unbedingt angemessen und stufenweise aufgebracht werden, um Bruch oder zufällige Beschädigung zu vermeiden.

910/16

Verbindungsstück, Innenvierkant 3/8",
Außenvierkant 1/2"



UNI/ISO 3316 DIN 3123

L mm	Ø mm	□	■	€	🔧	📄
32	18,0	3/8	1/2	11,40	5	009100814

910/20 - 910/21 - 910/22

Verlängerungen,
Innen- und Außenvierkant 3/8"

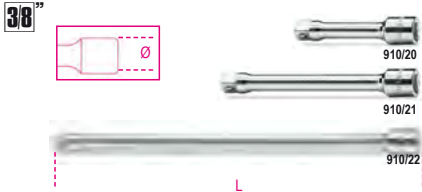

UNI/ISO 3316 DIN 3123

	L mm	Ø mm	€	🔧	📄
910/20	75	17	9,40	5	009100820
910/21	125	17	13,40	5	009100822
910/22	250	17	17,70	5	009100826

910AN

Verlängerungen, schwenkbar,
Innen- und Außenvierkant 3/8"

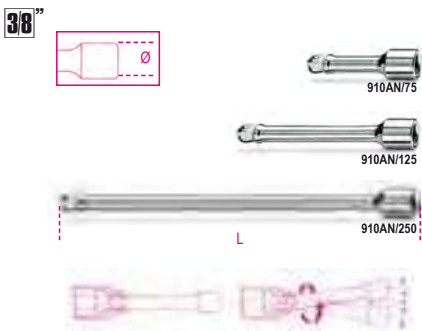

	L mm	Ø mm	€	🔧	📄
910AN/75	75	17	13,20	3	009100827
910AN/125	125	17	16,50	3	009100828
910AN/250	250	17	24,60	3	009100829

910/25

Kardangeln,
Innen- und Außenvierkant 3/8"



UNI/ISO 3316 DIN 3123

L mm	Ø mm	€	🔧	📄
54,6	19	24,30	5	009100830

910M/35

Metallgelenkgriff 3/8"



UNI/ISO 3315 DIN 3122

L mm	€	🔧	📄
250	66,50	3	009100839

910/36A

Gelenkgriff, Außenvierkant 3/8"



UNI/ISO 3315 DIN 3122

L mm	L1 mm	€	🔧	📄
255	154	47,00	3	009100845

910/40

Verlängerung mit Kardangeln,
Außenvierkant 3/8"



L mm	L1 mm	€	🔧	📄
420	175	50,50	3	009100850

910/42

Gleitgriff, Außenvierkant 3/8"

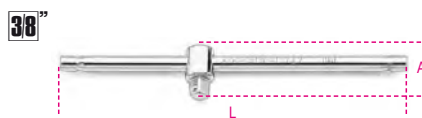

UNI/ISO 3315 DIN 3122

L mm	A mm	€	🔧	📄
210	30,5	15,90	5	009100854

910/46

Kurbel, Außenvierkant 3/8"

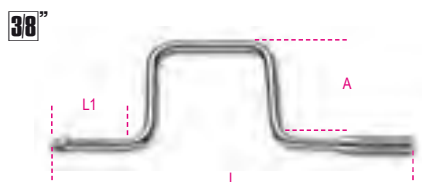

UNI/ISO 3315 DIN 3122

L mm	L1 mm	A mm	€	🔧	📄
315	80	115	31,50	1	009100862

910/55

Umschaltknarre
mit Außenvierkanttrieb 3/8", 72zahnig



UNI/ISO 3315 DIN 3122

L mm	Ø mm	A mm	€	🔧	📄
200	30	33	56,50	3	009100882

910/55Q

Umschaltknarre
mit Außenvierkanttrieb 3/8", 48zahnig



UNI/ISO 3315 DIN 3122

L mm	Ø mm	A mm	€	🔧	📄
200	30	33	56,50	3	009100885

Für die Ersatzdrehvorrichtungen
der Knarren,
s. Details nach Artikel 929/C8

910M/55

Umschaltknarre, Außenvierkant 3/8",
mit Metallgriff



DIN 3122 - UNI ISO 3315

L mm	Ø mm	A mm	€	🔧	📄
178	30	26	78,00	2	009100875



910M/56

Gelenkumschaltknarre,
Außenvierkant 3/8", mit Metallgriff

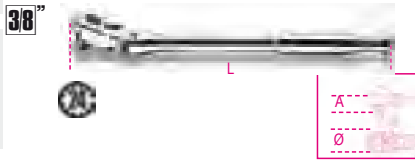

L mm	Ø mm	A mm	€	📦	📄
265	31	29	107,00	2	009100887

910/58

Umschaltknarre
mit Außenvierkantantrieb 3/8", Drehgriff,
52zahnig

- Anwendungssystem mit Drehgriff
- Buchsen-Auswurf-Taste
- Umschaltsystem am Kopf der Knarre
- Bimaterial-Griff



L mm	Ø mm	A mm	€	📦	📄
222	37	38,5	87,50	1	009100884

910.../C10

10 Steckschlüssel
und 2 Betätigungswerkzeuge



910A/C10	€	📦	📄
183,50	1	009100909	

○ 910A	6 - 7 - 8 - 10 - 11 - 12 13 - 14 - 17 - 19 mm
910/21	125 mm
910/55	

📏 270x120x45 mm - 📦 1,3 kg

910B/C10	€	📦	📄
183,50	1	009100910	

○ 910B	6 - 7 - 8 - 10 - 11 - 12 13 - 14 - 17 - 19 mm
910/21	125 mm
910/55	

📏 270x120x45 mm - 📦 1,3 kg

910A/C16...

16 Sechskant-Steckschlüssel
und 5 Betätigungswerkzeuge



910A/C16	€	📦	📄
297,00	1	009100936	

○ 910A	6 - 7 - 8 - 9 - 10 - 11 - 12 - 13 14 - 15 - 16 - 17 - 18 - 19 21 - 22 mm
910/21	125 mm
910/22	250 mm
910/25	
910/42	
910/55	

📏 335x145x60 mm - 📦 2,3 kg

9899 910C16	€	📦	📄
Thermoformateinsatz, leer	15,60	1	098990134

910A/C16Q	€	📦	📄
297,00	1	009100932	

○ 910A	6 - 7 - 8 - 9 - 10 - 11 - 12 - 13 14 - 15 - 16 - 17 - 18 - 19 21 - 22 mm
910/21	125 mm
910/22	250 mm
910/25	
910/42	
910/55Q	

📏 335x145x60 mm - 📦 2,3 kg

9899 910C16	€	📦	📄
Thermoformateinsatz, leer	15,60	1	098990134

910B/C16...

16 Zwölfkant-Steckschlüssel
und 5 Betätigungswerkzeuge



910B/C16	€	📦	📄
297,00	1	009100937	

○ 910B	6 - 7 - 8 - 9 - 10 - 11 - 12 - 13 14 - 15 - 16 - 17 - 18 - 19 21 - 22 mm
910/21	125 mm
910/22	250 mm
910/25	
910/42	
910/55	

📏 335x145x60 mm - 📦 2,3 kg

9899 910C16	€	📦	📄
Thermoformateinsatz, leer	15,60	1	098990134

910B/C16Q	€	📦	📄
297,00	1	009100933	

○ 910B	6 - 7 - 8 - 9 - 10 - 11 - 12 - 13 14 - 15 - 16 - 17 - 18 - 19 21 - 22 mm
910/21	125 mm
910/22	250 mm
910/25	
910/42	
910/55Q	

📏 335x145x60 mm - 📦 2,3 kg

9899 910C16	€	📦	📄
15,60	1	098990134	

Thermoformateinsatz, leer

910A/C17

17 Sechskant-Steckschlüssel
und 9 Betätigungswerkzeuge



910A/C17	€	📦	📄
445,00	1	009100938	

○ 910A	6 - 7 - 8 - 9 - 10 - 11 - 12 - 13 14 - 15 - 16 - 17 - 18 - 19 - 20 21 - 22 mm
910/15	□ 3/8 - ■ 1/4
910/16	□ 3/8 - ■ 1/2
910/21	125 mm
910/22	250 mm
910/25	
910/36A	
910/42	
910/46	
910/55	

📏 420x280x60 mm - 📦 4,0 kg



910.../C29

17 Steckschlüssel,
12 Schraubendrehereinsätze
und 5 Betätigungswerkzeuge



910A/C29 € 509,00 1 009100944

	○ 910A	6 - 7 - 8 - 9 - 10 - 11 - 12 - 13 14 - 15 - 16 - 17 - 18 - 19 - 20 21 - 22 mm
	● 910LP	1x5,5 - 1,2x6,5 - 1,2x8 mm
	⊕ 910PH	PH1 - PH2 - PH3
	○ 910PE	3 - 4 - 5 - 6 - 8 - 10 mm
	910/21	125 mm
	910/22	250 mm
	910/25	
	910/42	
	⊗ 910/55	

≡ 420x185x60 mm - 📦 3,5 kg

910B/C29 € 509,00 1 009100945

	○ 910B	6 - 7 - 8 - 9 - 10 - 11 - 12 - 13 14 - 15 - 16 - 17 - 18 - 19 - 20 21 - 22 mm
	● 910LP	1x5,5 - 1,2x6,5 - 1,2x8 mm
	⊕ 910PH	PH1 - PH2 - PH3
	○ 910PE	3 - 4 - 5 - 6 - 8 - 10 mm
	910/21	125 mm
	910/22	250 mm
	910/25	
	910/42	
	⊗ 910/55	

≡ 420x185x60 mm - 📦 3,5 kg

910AS/C13...

13 Zwölfkant-Steckschlüssel
und 5 Betätigungswerkzeuge



910AS/C13 € 302,00 1 009100925

	○ 910AS	1/4 - 5/16 - 11/32 - 3/8 - 7/16 1/2 - 9/16 - 19/32 - 5/8 - 11/16 3/4 - 13/16 - 7/8
	910/21	125 mm
	910/22	250 mm
	910/42	
	910/25	
	⊗ 910/55	

≡ 335x145x60 mm - 📦 2,3 kg

910AS/MBM-C18

13 Zwölfkant-Steckschlüssel
und 5 Betätigungswerkzeuge



910AS/MBM-C18 € 313,00 1 009100926

	○ 910AS	1/4 - 5/16 - 11/32 - 3/8 - 7/16 1/2 - 9/16 - 19/32 - 5/8 - 11/16 3/4 - 13/16 - 7/8
	910/21	125 mm
	910/22	250 mm
	910/25	
	910/42	
	910M/55	

≡ 335x145x60 mm - 📦 2,5 kg

910A/C16HR

16 Sechskant-Steckschlüssel und 5
Betätigungswerkzeuge
im festen Thermoformateinsatz,
im Blechkasten

• Knarre mit Drehgriff



910A/C16HR € 327,00 1 009100935

	○ 910A	6 - 7 - 8 - 9 - 10 - 11 - 12 - 13 14 - 15 - 16 - 17 - 18 - 19 21 - 22 mm
	910/21	125 mm
	910/22	250 mm
	910/25	
	910/42	210 mm
	910/58	

≡ 335x145x60 mm - 📦 2,4 kg



920A

Sechskant-Steckschlüssel



UNI/ISO 2725 DIN 3124

mm	Ø mm	L mm	Ø1 mm	€		
8	12,4	38	21,7	7,40	10	009200008
9	13,5	38	21,7	7,40	10	009200009
10	14,9	38	21,7	7,40	10	009200010
11	16,1	38	21,7	7,40	10	009200011
12	17,5	38	21,7	7,40	10	009200012
13	18,7	38	21,7	7,70	10	009200013
14	20,1	38	21,7	7,70	10	009200014
15	21,5	38	22,5	7,70	10	009200015
16	22,7	38	23,7	8,50	10	009200016
17	24,1	38	23,1	8,50	10	009200017
18	25,3	39	24,0	8,50	10	009200018
19	26,6	39	24,0	8,50	10	009200019
20	27,8	40	25,0	9,20	5	009200020
21	28,8	40	25,0	9,20	5	009200021
22	29,9	41	26,0	9,20	5	009200022
23	30,8	42	26,0	10,70	5	009200023
24	32,2	43	27,0	10,70	5	009200024
25	33,2	44	27,0	10,70	5	009200025
26	34,7	45	28,0	11,10	5	009200026
27	36,2	46	29,0	11,10	5	009200027
28	37,2	47	30,0	11,10	5	009200028
29	38,6	48	31,0	11,60	5	009200029
30	40,2	48	32,0	11,60	5	009200030
32	42,3	49	34,0	12,30	5	009200032



920A/SB13 € 128,00 1 009200040
10-11-12-13-14-15-16
17-18-19-20-21-22 mm



920A/SB8 € 105,00 1 009200042
23-24-25-26-27-28-30-32 mm



920MC

Sechskant-Steckschlüssel,
farbig



Ø mm	Ø mm	L mm	Ø1 mm	€	U	IT
8	13,2	38	22	7,90	5	009202008
10	15,3	38	22	7,90	5	009202010
11	16,5	38	22	7,90	5	009202011
12	17,8	38	22	7,90	5	009202012
13	19,0	38	22	8,30	5	009202013
14	20,3	38	22	8,30	5	009202014
15	21,6	38	22	8,30	5	009202015
16	23,0	38	23	9,20	5	009202016
17	23,9	38	24	9,20	5	009202017
18	25,0	38	25	9,20	5	009202018
19	26,5	38	24	9,20	5	009202019
21	28,8	38	27	10,00	3	009202021
22	29,9	40	28	10,00	3	009202022
24	32,8	40	30	11,60	3	009202024

920B

Zwölfkant-Steckschlüssel

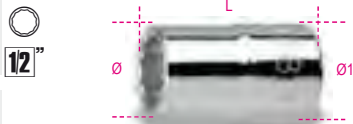

UNI/ISO 2725 DIN 3124

Ø mm	Ø mm	L mm	Ø1 mm	€	U	IT
8	12,4	38	21,7	7,40	10	009200108
9	13,5	38	21,7	7,40	10	009200109
10	14,9	38	21,7	7,40	10	009200110
11	16,1	38	21,7	7,40	10	009200111
12	17,5	38	21,7	7,40	10	009200112
13	18,7	38	21,7	7,70	10	009200113
14	20,1	38	21,7	7,70	10	009200114
15	21,5	38	22,5	7,70	10	009200115
16	22,7	38	23,7	8,50	10	009200116
17	24,1	38	23,1	8,50	10	009200117
18	25,3	39	24,0	8,50	10	009200118
19	26,6	39	24,0	8,50	10	009200119
20	27,8	40	25,0	9,20	5	009200120
21	28,8	40	25,0	9,20	5	009200121
22	29,9	41	26,0	9,20	5	009200122
23	30,8	42	26,0	10,70	5	009200123
24	32,2	43	27,0	10,70	5	009200124
25	33,2	44	27,0	10,70	5	009200125
26	34,7	45	28,0	11,10	5	009200126
27	36,2	46	29,0	11,10	5	009200127
28	37,2	47	30,0	11,10	5	009200128
29	38,6	48	31,0	11,60	5	009200129
30	40,2	48	32,0	11,60	5	009200130
32	42,3	49	33,9	12,30	5	009200132



920B/SB13 128,00 1 009200140
10-11-12-13-14-15-16
17-18-19-20-21-22 mm



920B/SB8 105,00 1 009200142
23-24-25-26-27
28-30-32 mm

920AL

Sechskant-Steckschlüssel,
lange Ausführung

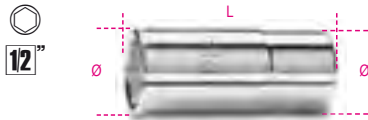

UNI/ISO 2725 DIN 3124

Ø mm	Ø mm	L mm	Ø1 mm	€	U	IT
10	14,7	77	21	19,80	5	009200626
12	17,8	77	21	19,80	5	009200627
13	19,0	77	22	19,80	5	009200628
14	20,3	77	22	19,80	5	009200629
15	21,5	77	22	19,80	5	009200630
16	22,8	77	22	21,30	5	009200631
17	24,0	77	23	21,30	5	009200632
18	25,0	77	24	22,40	5	009200633
19	26,5	77	25	22,40	5	009200634
21	29,0	77	27	24,80	5	009200635
22	30,0	77	28	24,80	5	009200636
23	31,5	77	29	24,80	5	009200637
24	32,8	77	30	28,50	5	009200638
27	36,5	77	33	29,50	3	009200639
30	40,0	77	36	36,00	3	009200640
32	42,8	77	38	36,50	3	009200641
36	48,0	77	41	58,00	3	009200642



920AL/SB11 255,00 1 009200644
10-12-13-14-15-16
17-18-19-21-22 mm

920BL

Zwölfkant-Steckschlüssel,
lange Ausführung

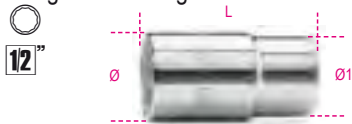

UNI/ISO 2725 DIN 3124

Ø mm	Ø mm	L mm	Ø1 mm	€	U	IT
10	14,7	77	21	19,80	5	009200310
12	17,8	77	21	19,80	5	009200312
13	19,0	77	22	19,80	5	009200313
14	20,3	77	22	19,80	5	009200314
15	21,5	77	22	19,80	5	009200315
16	22,8	77	22	21,30	5	009200316
17	24,0	77	23	21,30	5	009200317
18	25,0	77	24	22,40	5	009200318
19	26,5	77	25	22,40	5	009200319
21	29,0	77	27	24,80	5	009200321
22	30,0	77	28	24,80	5	009200322
23	31,5	77	29	24,80	5	009200323
24	32,8	77	30	29,00	5	009200324
27	36,5	77	33	29,50	3	009200327
30	40,0	77	36	36,00	3	009200330
32	42,8	77	38	36,50	3	009200332
36	48,0	77	41	58,50	3	009200336



920BL/SB11 255,00 1 009200338
10-12-13-14-15-16-17-18
19-21-22 mm

920A/AS

Sechskant-Steckschlüssel



Ø mm	Ø mm	L mm	Ø1 mm	€	U	IT
3/8	14,6	37	21	8,50	2	009200270
7/16	16,5	37	21	8,50	3	009200272
1/2	19,0	37	22	8,80	3	009200273
9/16	20,3	37	22	8,80	3	009200274
19/32	21,0	37	22	9,50	3	009200275
5/8	22,8	37	22	9,50	3	009200276
11/16	25,0	37	24	9,70	3	009200277
3/4	26,5	38	25	9,70	3	009200279
25/32	28,0	38	26	11,00	3	009200280
13/16	29,0	38	27	11,00	3	009200281
7/8	30,0	40	28	11,00	3	009200282
15/16	32,8	42	30	11,80	3	009200284
1	35,0	42	32	11,80	3	009200285
1.1/16	36,5	43	33	12,80	2	009200287
1.1/8	39,0	43	35	13,20	2	009200289
1.3/16	41,0	46	36	14,20	2	009200290
1.1/4	42,8	46	38	14,50	2	009200292



920A-AS/SB11 129,00 1 009200295
3/8-7/16-1/2-9/16-5/8
11/16-3/4-13/16-7/8
15/16-1

920AS

Zwölfkant-Steckschlüssel



Ø mm	Ø mm	L mm	Ø1 mm	€	U	IT
3/8	14,9	38	21,7	8,50	3	009200201
7/16	16,1	38	21,7	8,50	3	009200202
1/2	18,7	38	21,7	8,80	3	009200203
9/16	20,1	38	21,7	8,80	3	009200204
5/8	22,7	38	22,5	9,50	3	009200206
19/32	21,5	38	23,7	9,50	3	009200207
11/16	25,3	39	24,0	9,70	3	009200208
3/4	26,6	39	24,0	9,70	3	009200209
25/32	27,8	40	25,0	11,00	3	009200210
13/16	28,8	40	25,0	11,00	3	009200211
7/8	29,9	41	26,0	11,00	3	009200212
15/16	32,2	43	27,0	11,80	3	009200214
1	34,2	45	28,0	11,80	3	009200216
1.1/16	36,2	46	29,0	12,80	2	009200217
1.1/8	38,6	48	31,0	13,20	2	009200218
1.3/16	40,2	48	32,0	14,20	2	009200219
1.1/4	42,3	49	33,5	14,50	2	009200220



920AS/SB11 129,00 1 009200225
3/8-7/16-1/2-9/16-5/8
11/16-3/4-13/16-7/8
15/16-1

920AS/L

Zwölfkant-Steckschlüssel,
lange Ausführung



"	Ø mm	L mm	Ø1 mm	€	Hand	Code
1/2	19,0	77	22	27,50	2	009200352
9/16	20,3	77	22	27,50	2	009200353
5/8	22,8	77	22	27,50	2	009200355
11/16	25,0	77	24	29,00	2	009200357
3/4	26,5	77	25	30,00	2	009200358
13/16	29,0	77	27	35,50	2	009200360
7/8	30,0	77	28	35,50	2	009200361
15/16	32,8	77	30	36,50	2	009200362
1	35,0	77	32	37,00	2	009200363
1.1/16	36,5	77	33,0	41,00	2	009200364
1.1/8	37,8	77	34	42,00	2	009200365



920ASL/SB11 € 386,00 1 009200369
 1/2-9/16-5/8-11/16
 3/4-13/16-7/8-15/16
 1-1.1/8-1.1/16

920U

Multiprofil-Steckschlüssel

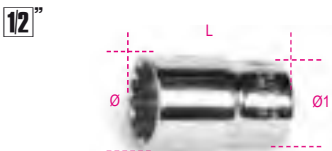

mm	"	Ø	Ø1	L mm	€	Hand	Code
10	3/8	E12	M12	38	7,70	5	009201710
11	7/16	E14	M14	38	7,70	5	009201711
12	15/32	E16		38	7,70	5	009201712
13	1/2	M16		38	8,10	5	009201713
14	9/16	E18	M18	38	8,10	5	009201714
15	19/32			38	8,10	5	009201715
16	5/8	E20		38	8,90	5	009201716
17				38	8,90	5	009201717
18		E22		38	8,90	5	009201718
19	3/4	E24		38	8,90	5	009201719
20	25/32			38	9,80	3	009201720
21				38	9,80	3	009201721
22	7/8			38	9,80	3	009201722
24	15/16			38	11,20	3	009201724
27	1.1/16			42	11,80	3	009201727
30	1.1/8			44	12,50	3	009201730
32	1.1/4			44	12,90	3	009201732



920U/SB13 € 134,00 1 009201740
 10-11-12-13-14-15-16
 17-18-19-20-21-22 mm



920U/SB4 € 57,50 1 009201744
 24-27-30-32 mm

920FTX

Steckschlüssel für Torx®-Schrauben



Ø mm	L mm	Ø1 mm	€	Hand	Code	
E10	13,2	36	21	12,10	5	009200380
E12	15,0	37	21	12,10	5	009200381
E14	16,3	37	21	12,10	5	009200382
E16	18,8	37	22	12,10	5	009200383
E18	20,4	37	22	12,10	5	009200384
E20	22,9	37	22	13,10	5	009200385
E22	25,0	37	24	15,10	3	009200387
E24	26,5	40	25	17,10	3	009200388



920FTX/SB6 € 85,00 1 009200390
 E10-E12-E14
 E16-E18-E20



920FTX/C8 € 143,50 1 009200391
 E10-E12-E14-E16
 E18-E20-E22-E24

270X120X45 mm - 1 kg

920FTX/L

Steckschlüssel für Torx®-Schrauben,
lange Ausführung

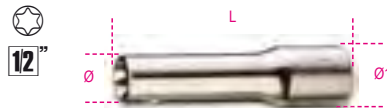

Ø mm	L mm	Ø1 mm	€	Hand	Code	
E10	13,2	77	21,0	25,00	5	009200400
E12	15,0	77	21,0	25,00	5	009200401
E14	16,3	77	21,0	25,00	5	009200402
E16	18,8	77	21,8	25,00	3	009200403
E18	20,4	77	21,8	25,00	3	009200404
E20	22,9	77	22,0	25,00	3	009200405



920FTX-LSB6 € 164,00 1 009200409
 E10-E12-E14
 E16-E18-E20

920LP

Schraubendrehereinsätze
für Schlitzschrauben

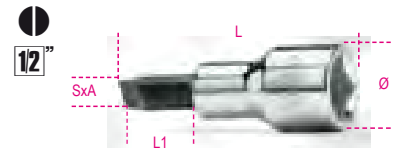

SxA mm	Ø mm	L mm	L1 mm	€	Hand	Code
1x5,5	22,5	62	24	19,50	3	009200452
1,2x6,5	22,5	62	24	19,50	3	009200453
1,2x8	22,5	62	24	19,50	3	009200454
1,6x9	22,5	62	24	19,50	3	009200456
2x12	22,5	62	24	19,50	3	009200458

920PH

Schraubendrehereinsätze
für Phillips®-Schrauben



PH	Ø mm	L mm	L1 mm	€	Hand	Code
1	22,5	56	18	17,20	3	009200471
2	22,5	56	18	17,20	3	009200472
3	22,5	56	18	17,20	3	009200473
4	22,5	56	18	17,20	3	009200474



920PH/SB4 € 78,50 1 009200479
 PH1-PH2-PH3-PH4

920LH/SB7

Schraubendrehereinsätze
für Phillips®-Schrauben



920LH/SB7 € 143,00 1 009200478
 920LP 1,2x6,5 - 1,2x8
 1,6x9 - 2x12 mm
 920PH PH2 - PH3 - PH4

920PE Sechskant-Steckschlüssel



DIN 7422

mm	Ø mm	L mm	L1 mm	€	U	PC
3	22,5	58	20	15,60	5	009200410
4	22,5	58	20	15,60	5	009200412
5	22,5	58	20	15,60	5	009200414
5L	22,5	100	62	17,10	5	009200415
6	22,5	58	20	15,60	5	009200417
6L	22,5	100	62	17,10	5	009200418
7	22,5	58	20	15,60	5	009200420
7L	22,5	100	62	17,10	5	009200421
8	22,5	58	20	15,60	5	009200423
8L	22,5	100	62	17,10	5	009200424
9	22,5	58	20	15,60	5	009200425
9L	22,5	140	102	17,90	5	009200426
10	22,5	58	20	15,60	5	009200428
10L	22,5	140	102	17,90	5	009200429
12	23,0	58	20	18,20	5	009200432
12L	22,5	140	102	20,80	5	009200433
14	22,5	58	20	18,20	5	009200434
14L	22,5	140	102	20,80	5	009200435
17	29,5	60	22	22,30	5	009200437
19	29,5	60	22	22,30	5	009200439



920PE/SB9
4-5-6-8-10 mm
5L-6L-8L-10L mm

€ 164,00 U 1 009200441



920PE/C10
4-5-6-7-8-10
12-14-17-19 mm

€ 213,00 U 1 009200443

270X120X45 mm - 1,5 kg

9899 920PE/C10
Thermoformateinsatz, leer

€ 15,60 U 1 098990135

920PE/AS Sechskant-Steckschlüssel



"	Ø mm	L mm	L1 mm	€	U	PC
1/8	22,5	58	20	18,30	2	009200460
3/16	22,5	58	20	18,30	2	009200461
1/4	22,5	58	20	18,30	2	009200463
3/8	22,5	58	20	18,30	2	009200464
1/2	22,5	60	20	20,00	2	009200465
3/4	22,5	60	20	21,50	1	009200468



920PE-AS/SB6
1/8-3/16-1/4-3/8-1/2-3/4

€ 128,00 U 1 009200469

920BP Sechskant-Steckschlüssel mit kugelförmigem Kopf

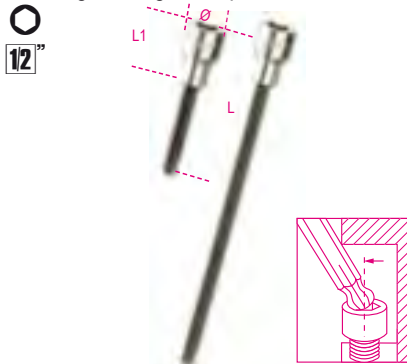

mm	Ø mm	L mm	L1 mm	€	U	PC
5L	22,5	100	62	19,70	5	009200490
5XL	22,5	240	202	25,50	1	009200495
6L	22,5	100	62	19,70	5	009200491
6XL	22,5	240	202	25,50	1	009200496
7L	22,5	100	62	19,70	5	009200492
8L	22,5	100	62	19,70	5	009200493
8XL	22,5	240	202	25,50	1	009200497
10L	22,5	140	102	21,50	5	009200494

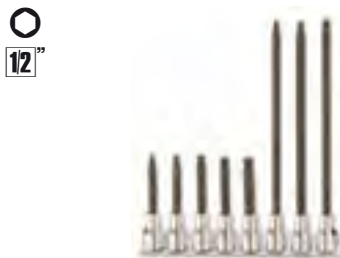

920BP/SB8
5L-6L-7L-8L-10L mm
5XL-6XL-8XL mm

€ 191,00 U 1 009200500

920ME Sechskant-Steckschlüssel



mm	Ø mm	L mm	L1 mm	€	U	PC
5	21	75	15,5	18,30	5	009200505
6	21	75	15,5	18,30	5	009200506
7	21	75	15,5	18,30	5	009200507
8	21	75	15,5	18,30	5	009200508
10	23	75	15,5	19,10	5	009200510
12	24	75	15,5	22,10	5	009200512
14	24	75	15,5	22,70	5	009200514
17	24	75	15,5	22,70	5	009200517



920ME/SB7
5-6-8-10-12-14-17 mm

€ 154,50 U 1 009200519



920ME/C7
5-6-8-10-12-14-17 mm

€ 173,50 U 1 009200518

250X100X35 mm - 1,4 kg

920TX Steckschlüssel, für Torx®-Schrauben

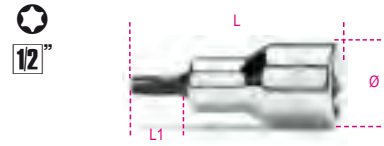

Ø mm	L mm	L1 mm	€	U	PC	
T20	22,5	58	20	19,10	5	009200520
T20L	22,5	120	82	24,50	3	009200530
T25	22,5	58	20	19,10	5	009200521
T25L	22,5	120	82	24,50	3	009200531
T27	22,5	58	20	19,10	5	009200522
T27L	22,5	120	82	24,50	3	009200533
T30	22,5	58	20	19,10	5	009200523
T30L	22,5	120	82	24,50	3	009200534
T40	22,5	58	20	19,10	5	009200524
T40L	22,5	120	82	24,50	3	009200535
T45	22,5	58	20	19,10	5	009200525
T45L	22,5	120	82	24,50	3	009200537
T50	22,5	58	20	19,10	5	009200526
T50L	23,0	140	102	24,50	3	009200538
T55	23,0	58	20	25,50	3	009200527
T55L	23,0	140	102	34,00	3	009200539
T60	23,0	58	20	25,50	3	009200528
T60L	23,0	140	102	34,00	3	009200540
T70L	23,0	120	82	34,00	3	009200541



920TX/SB9
T20-T25-T27-T30
T40-T45-T50-T55-T60

€ 201,00 U 1 009200532



920TX-L/SB10
T20L-T25L-T27L-T30L-T40L-
T45L-T50L-T55L-T60L-T70L

€ 292,00 U 1 009200545



920TX/C9
T20-T25-T27-T30-T40
T45-T50-T55-T60

€ 223,50 U 1 009200546

270X120X45 mm - 1,2 kg

9899 920TX/C9
Thermoformateinsatz, leer

€ 15,60 U 1 098990136

920RTX

Steckschlüssel, für Sicherheitsschrauben
Tamper Resistant Torx®



	Ø mm	L mm	L1 mm	€		
T20	22,5	58	20	20,50	5	009200370
T25	22,5	58	20	20,50	5	009200371
T27	22,5	58	20	20,50	5	009200372
T30	22,5	58	20	20,50	5	009200373
T40	22,5	58	20	20,50	5	009200374



920RTX/SB5
T20-T25-T27-T30-T40
€ 113,00 1 009200378

920XZN

Steckschlüssel für Vielzahnsschrauben
(XZN(R))

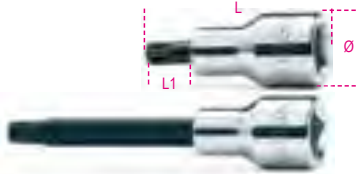

DIN 2324

	Ø mm	L mm	L1 mm	€		
M4	22,5	58	20	20,60	3	009200559
M5	22,5	58	20	20,60	3	009200560
M6	22,5	58	20	20,60	3	009200561
M6L	22,5	100	62	23,50	3	009200562
M8	22,5	58	20	20,60	3	009200563
M8L	22,5	100	62	23,50	3	009200564
M9	22,5	58	20	20,60	3	009200582
M9L	22,5	100	62	23,50	3	009200583
M10	22,5	58	20	20,80	3	009200565
M10L	22,5	100	62	23,50	3	009200566
M12	22,5	58	20	21,50	3	009200568
M12L	22,5	100	62	23,90	3	009200569
M14	23,0	58	20	21,50	3	009200571
M14L	23,0	100	62	23,90	3	009200572
M16	23,0	58	20	27,00	3	009200573
M18	23,0	58	20	27,50	3	009200574



920XZN/SB7
M4-M5-M6-M8
M10-M12-M14
€ 159,00 1 009200579



920XZN/SB12
M5-M6-M8-M10-M12
M14-M16-M6L-M8L
M10L-M12L-M14L
€ 291,00 1 009200577



920XZN-L/S5
M6L-M8L-M10L
M12L-M14L
€ 118,50 1 009200578

920ES

Schraubendrehereinsätze
für Innenkeilprofilschrauben

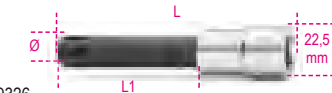

UNI 9326

Ø mm		L mm	L1 mm	€		
7	(6R)	58	20	28,50	5	009200587
7XL	(6R)	240	202	40,50	1	009200607
9	(8R)	58	20	28,50	5	009200589
9XL	(8R)	240	202	40,50	1	009200609
10	(8S)	58	20	28,50	5	009200590
10XL	(8S)	240	202	40,50	1	009200610
11	(10R)	58	20	28,50	5	009200591
11XL	(10R)	240	202	40,50	1	009200611
12L	(10S)	100	62	32,00	3	009200592
12XL	(10S)	240	202	44,00	1	009200612
14L	(12S)	100	62	32,00	3	009200594
14XL	(12S)	240	202	44,00	1	009200614
16L	(14R)	100	62	32,00	3	009200596
16XL	(14R)	240	202	44,00	1	009200616



920ES/SB7
7-9-10-11-12L-14L-16L
€ 224,50 1 009200598



920ES-XL/SB7
7XL-9XL-10XL-11XL
12XL-14XL-16XL
€ 307,00 1 009200618

PM 1/2-Q5



PM 1/2-Q5 € 72,560

920/15

Reduzierstück, Innenvierkant 1/2",
Außenvierkant 3/8"

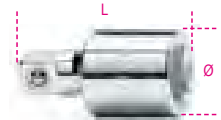

UNI/ISO 3316 DIN 3123

L mm	□	■	Ø mm	€		
42	1/2	3/8	22,0	12,40	5	009200810



Die Torsionslast muss unbedingt angemessen
und stufenweise aufgebracht werden,
um Bruch oder zufällige Beschädigung
zu vermeiden.

920/16

Verbindungsstück, Innenvierkant 1/2",
Außenvierkant 3/4"



UNI/ISO 3316 DIN 3123

L mm	□	■	Ø mm	€		
46	1/2	3/4	26	16,10	5	009200814

920/20÷920/23

Verlängerungen,
Innen- und Außenvierkant 1/2"

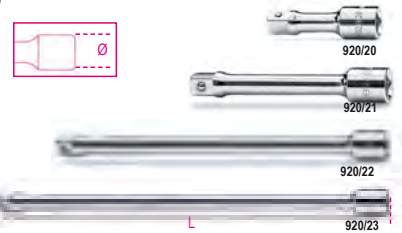

UNI/ISO 3316 DIN 3123

	L mm	Ø mm	€		
920/20	75	22	15,00	5	009200818
920/21	125	22	18,30	5	009200822
920/22	255	22	20,80	5	009200826
920/23	375	22	28,00	2	009200827

920AN

Verlängerungen, schwenkbar,
Innen- und Außenvierkant 1/2"

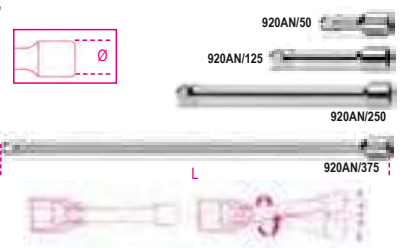

	L mm	Ø mm	€		
920AN/50	50	22	16,10	5	009200833
920AN/125	125	22	22,20	5	009200834
920AN/250	250	22	31,50	3	009200835
920AN/375	375	22	41,50	3	009200836

920/25
Kardangeln,
Innen- und Außenvierkant 1/2"



UNI/ISO 3316 DIN 3123

L	Ø	€	5	009200830
mm	mm			
75	27	29,00		

920/35A
Gelenkgriff, Außenvierkant 1/2"



UNI/ISO 3315 DIN 3122

L	L1	€	3	009200846
mm	mm			
285	160	58,00		

920M/35
Metallgelenkgriff, Außenvierkant 1/2"



UNI/ISO 3315 DIN 3122

L	€	2	009200845
mm			
380	83,50		

920M/35L
Metallgelenkgriff 1/2", lange Ausführung



L	€	1	009200843
mm			
600	126,50		



Die Torsionslast muss unbedingt angemessen und stufenweise aufgebracht werden, um Bruch oder zufällige Beschädigung zu vermeiden.

920/36A
Gelenkgriff, Außenvierkant 1/2"



UNI/ISO 3315 DIN 3122

L	L1	€	2	009200847
mm	mm			
408	283	65,50		

920/38
Gelenkgriff, Außenvierkant 1/2",
ausziehbar



L	L max	€	1	009200839
mm	mm			
262	402	99,00		

920/40
Verlängerung mit Kardangeln,
Außenvierkant 1/2"



L	L1	€	2	009200850
mm	mm			
490	230	68,00		

920/42
Gleitgriff, Außenvierkant 1/2"

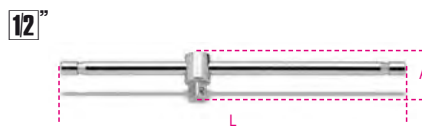

UNI/ISO 3315 DIN 3122

L	A	€	5	009200854
mm	mm			
305	42	20,60		

920/44
Winkelgriff, Außenvierkant 1/2"



UNI/ISO 3315 DIN 3122

L	L1	€	3	009200858
mm	mm			
230	60	30,50		

920/46
Kurbel, Außenvierkant 1/2"

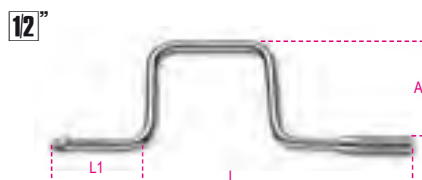

UNI/ISO 3315 DIN 3122

L	L1	A	€	1	009200862
mm	mm	mm			
385	110	160	37,00		

920/50
Einfachknarre mit Gleitvierkant 1/2",
72zahnig



UNI/ISO 3315 DIN 3122

L	Ø	A	€	3	009200871
mm	mm	mm			
275	40	42	65,00		

920/50F
Einfachknarre
mit Innenvierkanttrieb 1/2", 72zahnig

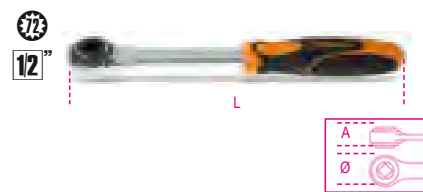

UNI/ISO 3315 DIN 3122

L	Ø	A	€	2	009200889
mm	mm	mm			
275	40	27	59,50		

920/55
Umschaltknarre
mit Außenvierkanttrieb 1/2", 72zahnig



UNI/ISO 3315 DIN 3122

L	Ø	A	€	3	009200882
mm	mm	mm			
275	40	43	69,00		

920/55Q
Umschaltknarre
mit Außenvierkanttrieb 1/2", 48zahnig



UNI/ISO 3315 DIN 3122

L	Ø	A	€	3	009200885
mm	mm	mm			
275	40	43	69,00		

920/55X

Umschaltknarre
mit Außenvierkantantrieb 1/2", 72zahnig



UNI/ISO 3315 DIN 3122

L	Ø	A	€		
mm	mm	mm			
200	30	33	58,50	3	009200895

920/55LC

Umschaltknarre mit
Außenvierkantantrieb 1/2",
mit "Locking System", 72zahnig

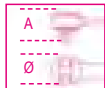

UNI/ISO 3315 DIN 3122

L	Ø	A	€		
mm	mm	mm			
275	40	43	80,00	2	009200896

920M/55

Umschaltknarre, Außenvierkant 1/2",
mit Metallgriff



L	Ø	A	€		
mm	mm	mm			
253	38	35	89,50	1	009200893

920/56A

Gelenkknarre
mit Außenvierkantantrieb 1/2", 72zahnig



L	Ø	A	€		
mm	mm	mm			
315	40	43	114,00	1	009200911

920M/56

Gelenkumschaltknarre,
Außenvierkant 1/2", mit Metallgriff



L	Ø	A	€		
mm	mm	mm			
330	38	35,7	119,00	2	009200894

920/58

Umschaltknarre
mit Außenvierkantantrieb 1/2",
52zahnig

- Anwendungssystem mit Drehgriff
- Buchsen-Auswurf-Taste
- Umschaltsystem am Kopf der Knarre
- Bimaterial-Griff

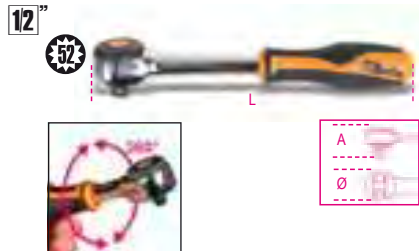

L	Ø	A	€		
mm	mm	mm			
281	42,5	45	104,50	1	009200926

Für die Ersatzdrehvorrichtungen
der Knarren,
s. Details nach Artikel 929/C8



920.../C11

11 Steckschlüssel
und 2 Betätigungswerkzeuge



920A/C11	€		
	219,50	1	009200921

Ø 920A	10 - 12 - 13 - 14 - 15 - 16 17 - 18 - 19 - 21 - 22 mm
920/22	255 mm
920/50	
335x145x60 mm - 2,5 kg	

920B/C11	€		
	219,50	1	009200922

Ø 920B	10 - 12 - 13 - 14 - 15 - 16 17 - 18 - 19 - 21 - 22 mm
920/22	255 mm
920/50	
335x145x60 mm - 2,5 kg	

920.../C12...

12 Steckschlüssel
und 5 Betätigungswerkzeuge



920A/C12X	€		
	321,00	1	009200933

Ø 920A	10 - 11 - 12 - 13 - 14 - 17 - 19 22 - 24 - 27 - 30 - 32 mm
920/21	125 mm
920/22	255 mm
920/25	
920/42	
920/55	
420x185x60 mm - 4,2 kg	

9899 920C12	€		
Thermoformateinsatz, leer	15,60	1	098990116

920A/C12	€		
	316,00	1	009200931

Ø 920A	10 - 11 - 12 - 13 - 14 - 17 - 19 22 - 24 - 27 - 30 - 32 mm
920/21	125 mm
920/22	255 mm
920/25	
920/42	
920/50	
420x185x60 mm - 4,2 kg	

9899 920C12 15,60 1 098990116
Thermoformateinsatz, leer

920B/C12X 321,00 1 009200934

- 920B 10 - 11 - 12 - 13 - 14 - 17 - 19
22 - 24 - 27 - 30 - 32 mm
- 920/21 125 mm
- 920/22 255 mm
- 920/25
- 920/42
- 920/55

420x185x60 mm - 4,0 kg

9899 920C12 15,60 1 098990116
Thermoformateinsatz, leer

920B/C12 316,00 1 009200932

- 920B 10 - 11 - 12 - 13 - 14 - 17 - 19
22 - 24 - 27 - 30 - 32 mm
- 920/21 125 mm
- 920/22 255 mm
- 920/25
- 920/42
- 920/50

420x185x60 mm - 4,0 kg

9899 920C12 15,60 1 098990116
Thermoformateinsatz, leer

920MC/C14

14 Sechskant-Steckschlüssel, farbig,
und 5 Betätigungswerkzeuge



920MC/C14 337,00 1 009202964

- 920MC 8 - 10 - 11 - 12 - 13 - 14 - 15 - 16 - 17
- 18 - 19 - 21 - 22 - 24 mm
- 920/21 125 mm
- 920/22 255 mm
- 920/25
- 920/42
- 920/55

420x185x60 mm - 4,2 kg

920.../C20...

20 Steckschlüssel
und 5 Betätigungswerkzeuge



920A/C20X 396,00 1 009200950

- 920A 10 - 11 - 12 - 13 - 14 - 15 - 16
17 - 18 - 19 - 20 - 21 - 22 - 23
24 - 26 - 27 - 28 - 30 - 32 mm
- 920/21 125 mm
- 920/22 255 mm
- 920/25
- 920/42
- 920/55

420x185x60 mm - 5,1 kg

9899 920C20 15,60 1 098990121
Thermoformateinsatz, leer

920A/C20 392,00 1 009200948

- 920A 10 - 11 - 12 - 13 - 14 - 15 - 16
17 - 18 - 19 - 20 - 21 - 22 - 23
24 - 26 - 27 - 28 - 30 - 32 mm
- 920/21 125 mm
- 920/22 255 mm
- 920/25
- 920/42
- 920/50

420x185x60 mm - 5,1 kg

9899 920C20 15,60 1 098990121
Thermoformateinsatz, leer

920A/C20Q 396,00 1 009200955

- 920A 10 - 11 - 12 - 13 - 14 - 15 - 16
17 - 18 - 19 - 20 - 21 - 22 - 23
24 - 26 - 27 - 28 - 30 - 32 mm
- 920/21 125 mm
- 920/22 255 mm
- 920/25
- 920/42
- 920/55Q

420x185x60 mm - 5,1 kg

9899 920C20 15,60 1 098990121
Thermoformateinsatz, leer

920B/C20 392,00 1 009200949

- 920B 10 - 11 - 12 - 13 - 14 - 15 - 16
17 - 18 - 19 - 20 - 21 - 22 - 23
24 - 26 - 27 - 28 - 30 - 32 mm
- 920/21 125 mm
- 920/22 255 mm
- 920/25
- 920/42
- 920/50

420x185x60 mm - 5,0 kg

9899 920C20 15,60 1 098990121
Thermoformateinsatz, leer

920B/C20X 396,00 1 009200951

- 920B 10 - 11 - 12 - 13 - 14 - 15 - 16
17 - 18 - 19 - 20 - 21 - 22 - 23
24 - 26 - 27 - 28 - 30 - 32 mm
- 920/21 125 mm
- 920/22 255 mm
- 920/25
- 920/42
- 920/55

420x185x60 mm - 5,0 kg

9899 920C20 15,60 1 098990121
Thermoformateinsatz, leer

920.../C21...

21 Steckschlüssel
und 6 Betätigungswerkzeuge



920A/C21 456,00 1 009200952

- 920A 10 - 11 - 12 - 13 - 14 - 15 - 16
17 - 18 - 19 - 20 - 21 - 22 - 23
24 - 25 - 26 - 27 - 28 - 30 - 32 mm
- 920/21 125 mm
- 920/22 255 mm
- 920/25
- 920/42
- 920/46
- 920/50

420x280x60 mm - 6,5 kg

920A/C21X 461,00 1 009200983

- 920A 10 - 11 - 12 - 13 - 14 - 15 - 16
17 - 18 - 19 - 20 - 21 - 22 - 23
24 - 25 - 26 - 27 - 28 - 30 - 32 mm
- 920/21 125 mm
- 920/22 255 mm
- 920/25
- 920/42
- 920/46
- 920/55

420x280x60 mm - 6,4 kg









920B/C21 456,00 1 009200953

- 920B 10 - 11 - 12 - 13 - 14 - 15 - 16
17 - 18 - 19 - 20 - 21 - 22 - 23
24 - 25 - 26 - 27 - 28 - 30 - 32 mm
- 920/21 125 mm
- 920/22 255 mm
- 920/25
- 920/42
- 920/46
- 920/50

420x280x60 mm - 6,4 kg



920B/C21X € 461,00 1 009200984

-  ○ 920B 10 - 11 - 12 - 13 - 14 - 15 - 16
17 - 18 - 19 - 20 - 21 - 22 - 23
24 - 25 - 26 - 27 - 28 - 30 - 32 mm
 -  920/21 125 mm
 -  920/22 255 mm
 -  920/25
 -  920/42
 -  920/46
 -  920/55
- ≡ 420x280x60 mm -  6,4 kg









920B/C300

30 Zwölfkant-Steckschlüssel
und 5 Betätigungswerkzeuge

12[™]



920B/C30Q € 650,00 1 009200975

-  ○ 920B 8 - 9 - 10 - 11 - 12 - 13 - 14
15 - 16 - 17 - 18 - 19 - 20 - 21
22 - 23 - 24 - 26 - 27 - 30 mm
 -  ○ 920BL 12 - 13 - 14 - 17 - 19 - 21
22 - 24 - 27 - 30 mm
 -  920/21 125 mm
 -  920/22 255 mm
 -  920/25
 -  920/42
 -  920/55Q
- ≡ 420x280x60 mm -  7,6 kg

Beta











920.../C33

20 Steckschlüssel,
13 Schraubendrehereinsätze
und 5 Betätigungswerkzeuge











12[™]



920A/C33 € 637,00 1 009200985

-  ○ 920A 10 - 11 - 12 - 13 - 14 - 15 - 16
17 - 18 - 19 - 20 - 21 - 22 - 23
24 - 26 - 27 - 28 - 30 - 32 mm
 -  ● 920LP 1,2x8 - 1,6x9 - 2x12 mm
 -  ⊕ 920PH PH2 - PH3 - PH4
 -  ○ 920PE 4 - 5 - 6 - 8 - 10 - 12 - 14 mm
 -  920/21 125 mm
 -  920/22 255 mm
 -  920/25
 -  920/42
 -  920/55
- ≡ 420x280x60 mm -  6,7 kg

920B/C33 € 637,00 1 009200986

-  ○ 920B 10 - 11 - 12 - 13 - 14 - 15 - 16
17 - 18 - 19 - 20 - 21 - 22 - 23
24 - 26 - 27 - 28 - 30 - 32 mm
 -  ● 920LP 1,2x8 - 1,6x9 - 2x12 mm
 -  ⊕ 920PH PH2 - PH3 - PH4
 -  ○ 920PE 4 - 5 - 6 - 8 - 10 - 12 - 14 mm
 -  920/21 125 mm
 -  920/22 255 mm
 -  920/25
 -  920/42
 -  920/55
- ≡ 420x280x60 mm -  6,7 kg

920A/C17M - 920A/C17MR







Sortiment aus 17 Sechskant-Steckschlüsseln
und 5 Betätigungswerkzeugen im
Schaumeinsatz
im Blechkasten

12[™]

12[™]



920A/C17M € 364,00 1 009200924

-  ○ 920A 10-11-12-13-14-15-16-17-18
19-20-21-22-24-27-30-32 mm
 -  920/21 125 mm
 -  920/22 255 mm
 -  920/25
 -  920/42 305 mm
 -  920/55
- ≡ 420x185x60 mm -  5 kg

9899 920C17 € 28,50 1 098990137
Schaumstoffeinsatz, leer

920A/C17MR € 399,00 1 009200937

-  920/21 125 mm
 -  920/22 255 mm
 -  920/25
 -  920/42 305 mm
 -  920/58
- ≡ 420x185x60 mm 5,1 kg









920/C37

37 Zwölfkant-Steckschlüssel
und 5 Betätigungswerkzeuge

12[™]



920/C37 € 596,00 1 009200988

-  ○ 920B 10 - 11 - 12 - 13 - 14 - 15 - 16
17 - 18 - 19 - 20 - 21 - 22 - 23
24 - 26 - 27 - 28 - 30 - 32 mm
 -  ○ 920AS 3/8 - 7/16 - 1/2 - 9/16 - 19/32
5/8 - 11/16 - 3/4 - 25/32 - 13/16
7/8 - 15/16 - 1 - 1.1/16 - 1.1/8
1.3/16 - 1.1/4
 -  920/21 125 mm
 -  920/22 255 mm
 -  920/25
 -  920/42
 -  920/55
- ≡ 420x280x60 mm -  7,5 kg

Beta

920AS/C10

10 Zwölfkant-Steckschlüssel
und 2 Betätigungswerkzeuge

12"



920AS/C10 € 227,00 1 009200919

- 920AS 3/8 - 7/16 - 1/2 - 9/16 - 5/8
11/16 - 3/4 - 13/16 - 7/8 - 15/16
 - 920/22 255 mm
 - 920/50
- 335x145x60 mm - 2,6 kg

920AS/C15

15 Zwölfkant-Steckschlüssel
und 6 Betätigungswerkzeuge

12"



920AS/C15 € 425,00 1 009200947

- 920AS 3/8 - 7/16 - 1/2 - 9/16 - 5/8 - 11/16
3/4 - 13/16 - 7/8 - 15/16 - 1
1.1/16 - 1.1/8 - 1.3/16 - 1.1/4
 - 920/21 125 mm
 - 920/22 255 mm
 - 920/25
 - 920/42
 - 920/46
 - 920/50
- 420x280x60 mm - 5,9 kg



920AS/C17X

17 Zwölfkant-Steckschlüssel
und 5 Betätigungswerkzeuge

12"



920AS/C17X € 396,00 1 009200942

- 920AS 3/8 - 7/16 - 1/2 - 9/16 - 19/32 - 5/8
11/16 - 3/4 - 25/32 - 13/16 - 7/8
15/16 - 1 - 1.1/16 - 1.1/8 - 1.3/16 -
1.1/4
 - 920/21 125 mm
 - 920/22 255 mm
 - 920/25
 - 920/42
 - 920/55
- 420x185x60 mm - 4,8 kg

920AS/MBM-C21

16 Zwölfkant-Steckschlüssel
und 5 Betätigungswerkzeuge

12"



920AS/MBM-C21 € 403,00 1 009200944

- 920AS 3/8 - 7/16 - 1/2 - 9/16
19/32 - 5/8 - 11/16 - 3/4
25/32 - 13/16 - 7/8 - 15/16
1 - 1.1/16 - 1.3/16 - 1.1/4
 - 920M/55
 - 920/21 125 mm
 - 920/22 255 mm
 - 920/25
 - 920/42
- 420x185x60 mm - 5,0 kg

920TX/C17

6 Schraubeinsätze, 6 Steckschlüssel,
5 Steckschlüssel mit Innenvierkanttrieb
und 4 Betätigungswerkzeuge,
für Torx®-Schrauben

12"



12"

920TX/C17 € 373,00 1 009200989

- 861TX T8 - T10 - T15 - T20 - T25 - T27
 - 897
 - 920TX T27 - T30 - T40 - T45 - T50
 - 920FTX E10 - E12 - E14 - E16 - E18 - E20
 - 920/20 75 mm
 - 920/22 255 mm
 - 920/55
- 420x185x60 mm - 2,9 kg

920A/C17HR

17 Sechskant-Steckschlüssel und 5
Betätigungswerkzeuge
im festen Thermofomateinsatz, im
Blechkasten
• Knarre mit Drehgriff

12"



920A/C17HR € 410,00 1 009200939

- 920A 10-11-12-13-14-15-16-17-18
19-20-21-22-24-27-30-32 mm
 - 920/21 125 mm
 - 920/22 255 mm
 - 920/25
 - 920/42
 - 920/58
- 420x185x60 mm - 5,1 kg



920U/C17M

17 Multiprofil-Steckschlüssel
und 5 Betätigungswerkzeuge,
im Schaumstoffeinsatz

12"



920U/C17M € 372,00 1 009201797

920U ○ 10-11-12-13-14-15-16-17-18-19-20
21-22-24-27-30-32 mm
* 3/8-7/16-15/32-1/2-9/16-19/32-5/8-3/4
25/32-7/8-15/16-1.1/16-1.1/8-1.1/4
○ M12-M14-M16-M18
○ E12-E14-E16-E18-E20-E22-E24

920/21 125 mm
920/22 255 mm
920/25
920/42 305 mm
920/55 275 mm

420x185x60 mm - 5 kg

9899 920C17 € 28,50 1 098990137
Schaumstoffeinsatz, leer

928A

Sechskant-Steckschlüssel

3/4"

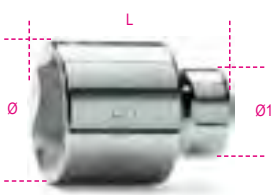

UNI/ISO 2725
DIN 3124

Ø mm	Ø mm	L mm	Ø1 mm	€	5	10
19	29,2	50	34	18,70	5	009280019
21	30,0	51	34	19,00	5	009280021
22	31,3	53	34	19,00	5	009280022
23	33,3	53	34	19,30	5	009280023
24	34,5	53	34	19,70	5	009280024
26	36,8	55	35	21,10	5	009280026
27	38,0	56	35	21,10	5	009280027
28	39,0	57	35	22,40	3	009280028
29	40,2	58	35	22,80	3	009280029
30	41,5	58	37	23,40	3	009280030
32	44,3	60	37	24,30	3	009280032
33	45,8	60	37	25,50	3	009280033
34	46,8	60	37	26,00	3	009280034
35	48,1	62	38	27,00	3	009280035
36	49,5	64	38	27,00	3	009280036
38	52,0	68	40	29,00	3	009280038
41	56,0	71	40	32,50	3	009280041
46	62,3	75	43	39,50	3	009280046
50	67,4	80	43	48,00	3	009280050
55	73,7	84	48	59,00	1	009280055
60	80,0	87	48	68,00	1	009280060

928B

Zwölfkant-Steckschlüssel

3/4"



UNI/ISO 2725
DIN 3124

Ø mm	Ø mm	L mm	Ø1 mm	€	5	10
19	29,2	50	34	18,70	5	009280119
21	30,0	51	34	19,00	5	009280121
22	31,3	53	34	19,00	5	009280122
23	33,3	53	34	19,30	5	009280123
24	34,5	53	34	19,70	5	009280124
26	36,8	55	35	21,10	5	009280126
27	38,0	56	35	21,10	5	009280127
28	39,0	57	35	22,40	3	009280128
29	40,2	58	35	22,80	3	009280129
30	41,5	58	37	23,40	3	009280130
32	44,3	60	37	24,30	3	009280132
33	45,8	60	37	25,50	3	009280133
34	46,8	60	37	26,00	3	009280134
35	48,1	62	38	27,00	3	009280135
36	49,5	64	38	27,00	3	009280136
38	52,0	68	40	29,00	3	009280138
41	56,0	71	40	32,50	3	009280141
46	62,3	75	43	39,50	3	009280146
50	67,4	80	43	48,00	3	009280150
55	73,7	84	48	59,00	1	009280155
60	80,0	87	48	68,00	1	009280160

928AS

Sechskant-Steckschlüssel

3/4"

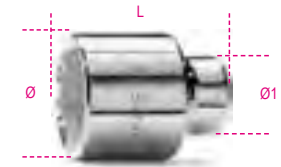

Ø mm	Ø mm	L mm	Ø1 mm	€	5	10
7/8	32,0	53	34	21,50	1	009280202
15/16	34,5	53	34	21,50	1	009280203
1	36,2	55	35	22,70	1	009280204
1.1/16	38,0	56	35	23,50	1	009280205
1.1/8	40,2	58	35	24,00	1	009280206
1.1/4	44,2	60	37	26,00	1	009280208
1.5/16	45,8	60	37	27,50	1	009280209
1.3/8	48,1	62	38	28,50	1	009280210
1.7/16	49,5	64	38	30,00	1	009280211
1.1/2	52,0	68	40	32,00	1	009280212
1.5/8	56,0	71	40	35,50	1	009280214
1.11/16	58,8	74	40	40,50	1	009280215
1.13/16	62,3	75	43	45,00	1	009280217
1.7/8	65,0	78	43	48,50	1	009280218
2	68,3	80	43	55,00	1	009280219
2.1/16	71,5	83	48	65,00	1	009280220

928ME

Sechskant-Steckschlüssel

3/4"

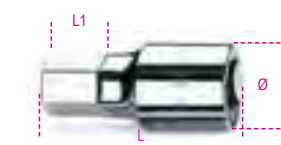

mm	Ø mm	L mm	L1 mm	€	5	10
14	35	75	15,5	43,50	2	009280514
17	35	75	15,5	43,50	2	009280517
19	35	75	15,5	43,50	2	009280519
22	35	75	22,5	43,50	2	009280522

928/15

Reduzierstück, Innenvierkant 3/4",
Außenvierkant 1/2"

3/4"



UNI/ISO 3316
DIN 3123

L mm 51,5 Ø mm 34 3/4 1/2 € 22,70 5 009280801



Die Torsionslast muss unbedingt angemessen
und stufenweise aufgebracht werden,
um Bruch oder zufällige Beschädigung
zu vermeiden.

928/16

Verbindungsstück, Innenvierkant 3/4",
Außenvierkant 1"

3/4"

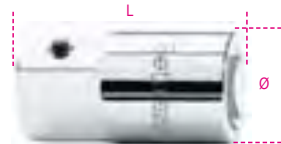

UNI/ISO 3316
DIN 3123

L mm 65 Ø mm 34 3/4 1" € 27,50 5 009280807

928/20 - 928/21 - 928/22

Verlängerungen,
Innen- und Außenvierkant 3/4"

3/4"



UNI/ISO 3316
DIN 3123

928/20	L mm	Ø mm	€	5	10
928/20	100	34	27,00	3	009280810
928/21	200	34	36,00	3	009280815
928/22	380	34	52,50	3	009280825

928/25

Kardangelen,
Innen- und Außenvierkant 3/4"

3/4"



UNI/ISO 3316 DIN 3123

L mm 108 Ø mm 40 € 90,00 1 009280830

928/36A

Gelenkgriff, Außenvierkant 3/4"



DIN 3122 - UNI ISO 3315

L
mm
545

€
108,00

1 009280844

928/42

Gleitgriff, Außenvierkant 3/4"

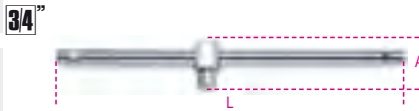

UNI/ISO 3315 DIN 3122

L mm 450

A mm 62,5

€ 56,50

3 009280850

928/55

Umschaltknarre, Außenvierkanttrieb 3/4", 72zahnig

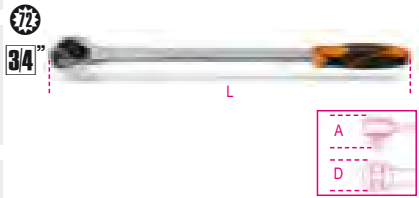

DIN 3122 - UNI ISO 3315

L mm 510

Ø mm 58

A mm 59

€ 183,00

2 009280862

Für die Ersatzdrehvorrichtungen der Knarren, s. Details nach Artikel 929/C8

928.../C12

Sortiment mit 12 Sechskant-Steckschlüsseln und 5 Betätigungswerkzeugen, im Blechkasten



928A/C12 968,00 1 009280955

○ 928A	22 - 24 - 27 - 30 - 32 - 34 - 36 38 - 41 - 46 - 50 - 55 mm
928/21	200 mm
928/22	380 mm
928/25	
928/42	
928/55	

530x220x80 mm - 13,5 kg

928B/C12 968,00 1 009280957

○ 928B	22 - 24 - 27 - 30 - 32 - 34 - 36 38 - 41 - 46 - 50 - 55 mm
928/21	200 mm
928/22	380 mm
928/25	
928/42	
928/55	

530x220x80 mm - 13,5 kg

928AS/C12

Sortiment mit 12 Sechskant-Steckschlüsseln und 5 Betätigungswerkzeugen, im Blechkasten



928AS/C12 1.004,00 1 009280968

○ 928AS	7/8-15/16-1.1/16-1.1/8-1.1/4 1.5/16-1.7/16-1.1/2-1.11/16 1.13/16-1.7/8-2.1/16
928/21	200 mm
928/22	380 mm
928/25	
928/42	
928/55	

530x220x80 mm - 13,5 kg

929

Sechskant-Steckschlüssel



UNI/ISO 2725 DIN 3124

Ø mm	Ø mm	L mm	Ø1 mm	€	1	009290036
36	51	65	48	39,50	1	009290036
41	57	70	48	42,00	1	009290041
46	65	75	48	47,00	1	009290046
50	70	80	48	54,00	1	009290050
55	76	85	54	63,50	1	009290055
60	82	90	54	68,00	1	009290060
65	88	95	54	87,50	1	009290065
70	92	100	60	105,00	1	009290070
75	99	110	60	114,00	1	009290075
80	106	120	60	130,50	1	009290080

929/15

Reduzierstück, Innenvierkant 1", Außenvierkant 3/4"



UNI/ISO 3316 DIN 3123

L mm 65

Ø mm 47

1" 3/4

€ 47,00

2 009290801



Die Torsionslast muss unbedingt angemessen und stufenweise aufgebracht werden, um Bruch oder zufällige Beschädigung zu vermeiden.

929/21 - 929/22

Verlängerungen, Innen- und Außenvierkant 1"



UNI/ISO 3316 DIN 3123

	L mm	Ø mm	€	1	009290815
929/21	200	47	60,50	1	009290815
929/22	400	47	87,50	1	009290825

929/42

Gleitgriff, Außenvierkant 1"



UNI/ISO 3315 DIN 3122

L mm 535

€ 113,00

1 009290850

929/55

Umschaltknarre mit Außenvierkanttrieb 1", 72zahnig



UNI/ISO 3315 DIN 3122

L mm 770

Ø mm 62

A mm 63

€ 243,00

1 009290860

929/55PR

Verlängerungen für Umschaltknarren Art. 929/55



L	Ø	Ø1	€	📦	📄
mm	mm	mm			
540	32	26	52,00	1	009290868

929/C8

8 Sechskant-Steckschlüssel und 5 Betätigungswerkzeuge

1"



929/C8	€	📦	📄
	1.420,00	1	009290925

929	46 - 50 - 55 - 60 - 65 70 - 75 - 80 mm
929/15	□ 1" - ■ 3/4
929/21	200 mm
929/22	400 mm
929/42	
929/55	

📦 560x290x120 mm - 📦 29 kg

9899 CV/A

Leerer Kasten



9899 CV/A	€	📦	📄
	38,50	1	098990001

583/C31-671B/C5-671B/C10-720ME/C8
860/C38P-861/C61P-900/C11-900AS/C10-MB-C17
900/C24-900/C13-8-900/C13-5-900MB/C19-900MB/C28
900/C11HR-900AS/C10-MB-C17-900AS/C17-MBM
900/C11Z-900MC/C24-900MC/C32-910.../C10
971/C8-920TX/C-920PE/C-920FTX/C-910.../C10

📦 270x120x45 mm

9899 CV/B

Leerer Kasten



9899 CV/B	€	📦	📄
	44,50	1	098990002

352C/U-720MC/C13-727/C16-867/C20-900/C12MR
900/C12MZ-900U/C12M-910AS/C13...-910AS/MBM-C18
910A/C16...-910B/C16...-910A/C16HR
910A/C16...-910B/C16...-920AS/C10-920.../C11-1433/C11
1494/C14A-1529-1545/C5M

📦 335x145x60 mm

9899 CV/C

Leerer Kasten



9899 CV/C	€	📦	📄
	55,00	1	098990003

920A/C17HR-920A/C17MR-920.../C12...
920A/C17M-910.../C29-902A/C22-867/C38
720/C24-450/C15-353N/C6-960KPC-920MC/C14
920U/C17M-920TX/C17-920.../C20...
920AS/MBM-C21-920AS/C17X-1547/C6-1495/C6
1489/C14-1461/C11A-1608/C9-1606A/C9-1602/C9

📦 420x185x60 mm

900/R55



900/R55	€	📦	📄
666N/2-900/55-666/2-666LBF.FT/2	39,50	1	009000871

900/R55-Z



900/R55-Z	€	📦	📄
	39,50	1	009000872

900M/R55



900M/R55	€	📦	📄
900M/55	20,80	1	009000888

910/R55

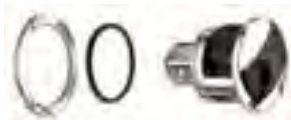

910/R55	€	📦	📄
599DGT/6-606/6-606/10-612-665/6-665/10-665LB/6 665LB/10-666N/5-666N/10-666N LBF.IN/5-666NLBF.IN/10 666/6-666/10-668RGC/6-668RGC/10-910/55-666/5 666HS/5-666HS/10-666 LBF.FT/5-666 LBF.FT/10	38,50	1	009100879

910M/R55



910M/R55	€	📦	📄
910M/55-910M/56	21,50	1	009100888

910/R55Q



910/R55Q	€	📦	📄
910/55Q	38,50	1	009100877

910/R55X



910/R55X	€	📦	📄
666N/2X-666/2X-666 LBF.FT/2X	38,50	1	009100897

920/R50



920/R50	€	📦	📄
614/50-667/20-667/30 667N/20-667N/30-920/50	37,50	1	009200866

920/R55

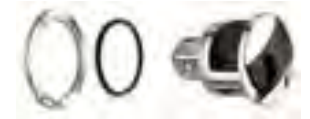

920/R55	€	📦	📄
606/20-606/30-666/20-666/30-920/55 920/56A- 599DGT/20-599DGT/30 599DGT-AN/20-665/20-665/30-665LB/20 665LB/30-666N/20-666N/30 666N LBF.IN/20-666N LBF.IN/30-668RGC/20 666 LBF.FT/20-666 LBF.FT/30	46,50	1	009200879

920M/R55



920M/R55	€	📦	📄
920M/55-920M/56	24,00	1	009200888

920/R55Q



920/R55Q	€	📦	📄
920/55Q	46,50	1	009200877

920/R55X

12
7/32



920/R55X
606/10X-612X
666/10X-920/55X-599DGT/10X-599DGT-AN/10
665/10X-665LB/10X-666N10X-666N LBF.IN/10X
668RGC/10X-666 LBF.FT/10X
666HS/20LC-666HS/30LC

€ 37,50 1 009200878

920/R55LC

12
7/32



920/R55LC
920/55LC "Locking System"
666HS/20LC-666HS/30LC

€ 48,50 1 009200887

928/R55

3/4
7/32



928/R55
928/55

€ 77,00 1 009280859

928/R55X

3/4
7/32



928/R55X
614X

€ 49,00 1 009280858

929/R55

1
7/32



929/R55
929/55

€ 89,00 1 009290859

930

Doppelsteckschlüssel, Zwölfkant-Köpfe, schwere Ausführung



UNI 6745

mm	L mm	Ø mm	Ø1 mm	€	U	PC
6x7	100	9,5	11,0	15,60	3	009300006
8x9	108	12,5	14,0	19,60	3	009300010
10x11	116	15,0	16,5	20,50	3	009300014
12x13	124	17,5	19,0	24,10	3	009300018
14x15	132	20,0	21,5	26,00	3	009300023
16x17	140	23,0	24,0	30,00	3	009300027

mm	L mm	Ø mm	Ø1 mm	€	U	PC
18x19	148	25,0	26,5	33,50	3	009300032
20x22	156	28,0	30,0	37,00	2	009300036
21x23	163	29,0	31,5	39,00	2	009300040
24x26	173	33,0	35,5	50,00	2	009300044
25x28	182	34,5	38,0	54,00	2	009300048
27x29	191	37,0	39,5	61,50	2	009300052
30x32	200	40,5	43,0	74,50	2	009300056



930/S8 € 221,50 1 009300081

6x7-8x9-10x11-12x13-14x15
16x17-18x19-20x22 mm

940/1 - /2

930/S13 € 516,00 1 009300083

6x7-8x9-10x11-12x13-14x15-16x17

18x19-20x22-21x23-24x26

25x28-27x29-30x32 mm

940/1 - /2 - /3



930/C13 € 594,00 1 009300098

6x7-8x9-10x11-12x13

14x15-16x17-18x19

20x22-21x23-24x26

25x28-27x29-30x32 mm

940/1 - /2 - /3

932

Doppelsteckschlüssel, 12kant x 6kant, verchromt, poliert

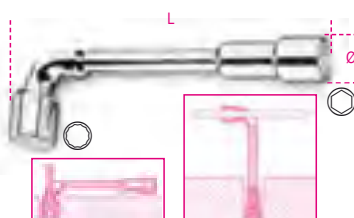

NF E 74.303

mm	Ø mm	L mm	€	U	PC
6x6	11,5	110	17,50	5	009320006
7x7	12,5	116	17,70	5	009320007
8x8	13,0	120	18,40	5	009320008
9x9	14,0	125	19,00	5	009320009
10x10	16,5	133	19,80	5	009320010
11x11	17,5	143	21,60	5	009320011
12x12	19,0	148	23,00	5	009320012
13x13	19,5	154	24,00	5	009320013
14x14	21,5	167	25,50	5	009320014
15x15	22,5	182	26,50	5	009320015
16x16	24,5	193	28,00	5	009320016
17x17	26,0	198	28,00	5	009320017
18x18	26,5	215	31,00	5	009320018
19x19	29,0	220	33,50	5	009320019
20x20	30,5	222	36,00	3	009320020
21x21	30,5	236	41,00	3	009320021
22x22	32,5	250	44,50	2	009320022
23x23	33,5	256	50,00	2	009320023
24x24	35,0	272	53,00	2	009320024
25x25	36,5	282	56,50	2	009320025

mm	Ø mm	L mm	€	U	PC
26x26	37,5	296	62,00	2	009320026
27x27	39,0	296	65,00	2	009320027
28x28	39,0	314	74,00	2	009320028
30x30	42,5	348	88,50	2	009320030
32x32	45,5	364	98,00	2	009320032



932/S11 € 273,00 1 009320080

6-7-8-10-11-12

13-14-17-19-22 mm

932/S17

6-7-8-9-10-11-12 13-14-15

16-17-18-19-20-21-22 mm

932/S25

6-7-8-9-10-11-12-13-14-15-16-17-18-19

20-21-22-23-24-25-26-27-28-30-32 mm

€ 999,00 1 009320082

933

Doppelsteckschlüssel, 6kant x 6kant, verchromt, poliert

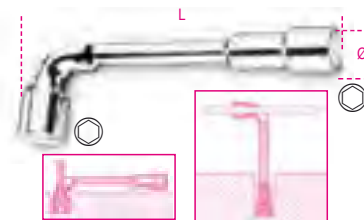

NF E 74.303

mm	Ø mm	L mm	€	U	PC
6x6	11,5	110	17,50	5	009330006
7x7	12,5	116	17,70	5	009330007
8x8	13,0	120	18,40	5	009330008
9x9	14,0	125	19,00	5	009330009
10x10	16,5	133	19,80	5	009330010
11x11	17,5	143	21,60	5	009330011
12x12	19,0	148	23,00	5	009330012
13x13	19,5	154	24,00	5	009330013
14x14	21,5	167	25,50	5	009330014
15x15	22,5	182	26,50	5	009330015
16x16	24,5	193	28,00	5	009330016
17x17	26,0	198	28,00	5	009330017
18x18	26,5	215	31,00	5	009330018
19x19	29,0	220	33,50	5	009330019
20x20	30,5	222	36,00	3	009330020
21x21	30,5	236	41,00	3	009330021
22x22	32,5	250	44,50	2	009330022
23x23	33,5	256	50,00	2	009330023
24x24	35,0	272	53,00	2	009330024
25x25	36,5	282	56,50	2	009330025
26x26	37,5	296	62,00	2	009330026
27x27	39,0	296	65,00	2	009330027
28x28	39,0	314	74,00	2	009330028
30x30	42,5	348	88,50	2	009330030
32x32	45,5	364	98,00	2	009330032



933/S11 € 273,00 1 009330080

6-7-8-10-11-12-13-14-17-19-22 mm

933/S17

6-7-8-9-10-11-12-13-14-15-16-17

18-19-20-21-22 mm

933/S25

6-7-8-9-10-11-12-13-14-15-16-17-18-19

20-21-22-23-24-25-26-27-28-30-32 mm

€ 999,00 1 009330082

935

Doppelsteckschlüssel, Sechskant-Köpfe, leichte Ausführung



UNI 6746 DIN 896

Ø mm	L mm	€	Hand	Computer
6x7	100	9,10	5	009350105
8x9	110	9,80	5	009350111
10x11	120	10,90	5	009350115
12x13	130	12,40	5	009350117
14x15	140	14,20	5	009350126
16x17	150	15,60	5	009350128
18x19	160	18,40	5	009350131
20x22	170	22,30	3	009350138
21x23	180	24,70	3	009350141
24x26	190	28,00	3	009350144
25x28	200	31,50	2	009350150
27x29	210	36,50	2	009350153
30x32	220	39,00	2	009350156



935/S8 127,50 € 1 009350181
6x7-8x9-10x11-12x13-14x15-16x17
18x19-20x22 mm

940/1 - /2

935/S13 302,00 € 1 009350183

6x7-8x9-10x11-12x13-14x15-16x17

18x19-20x22-21x23-24x26-25x28

27x29-30x32 mm

940/1 - /2 - /3

937

Doppelsteckschlüssel, 12kant x 6kant, verchromt

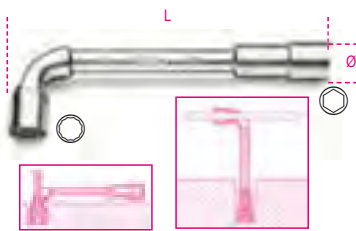

Ø mm	Ø mm	L mm	€	Hand	Computer
6x6	11,5	110	9,90	5	009370006
7x7	12,5	116	10,10	5	009370007
8x8	13,0	120	10,50	5	009370008
9x9	14,0	125	11,20	5	009370009
10x10	16,5	133	11,70	5	009370010
11x11	17,5	143	12,40	5	009370011
12x12	19,0	148	13,70	5	009370012
13x13	19,5	154	14,00	5	009370013
14x14	21,5	167	15,40	5	009370014
15x15	22,5	182	16,90	5	009370015
16x16	24,5	193	18,30	5	009370016
17x17	26,0	198	19,00	5	009370017
18x18	26,5	215	19,40	5	009370018
19x19	29,0	220	20,20	5	009370019
20x20	30,5	222	22,90	3	009370020
21x21	30,5	236	25,00	3	009370021
22x22	32,5	250	26,50	2	009370022
23x23	33,5	256	29,00	2	009370023
24x24	35,0	272	30,00	2	009370024
25x25	36,5	282	38,50	2	009370025
26x26	37,5	296	39,50	2	009370026
27x27	39,0	296	40,50	2	009370027
28x28	39,0	314	48,50	2	009370028
30x30	42,5	348	52,00	2	009370030
32x32	45,5	364	58,50	2	009370032



937/S11 162,00 € 1 009370080

6-7-8-10-11-12-13-14-17-19-22 mm

937/S17 275,00 € 1 009370081

6-7-8-9-10-11-12-13-14-15-16-17

18-19-20-21-22 mm

940

Drehstifte für Doppelsteckschlüssel Art. 930 und 935



940/1 6+13 mm 100 mm 6,80 € 5 009400001

940/2 14+22 mm 170 mm 8,90 € 5 009400002

940/3 21+32 mm 290 mm 15,90 € 5 009400003

941

Steck-Schlüssel, 12kant x 6kant, mit Griff



7x7 200 mm 91 mm 35 mm 32,50 € 2 009410107

8x8 220 mm 107 mm 50 mm 36,00 € 2 009410108

9x9 220 mm 109 mm 50 mm 36,00 € 2 009410109

10x10 236 mm 111 mm 50 mm 36,50 € 2 009410110

11x11 236 mm 114 mm 50 mm 38,00 € 2 009410111

12x12 255 mm 122 mm 50 mm 42,50 € 2 009410112

13x13 255 mm 124 mm 55 mm 43,00 € 2 009410113



941/S7 262,00 € 1 009410170

7-8-9-10-11-12-13 mm

STECKSCHLÜSSEL MIT GRIFF

Geeignet für schnelles und wiederholendes Verschrauben. Die minimale Dicke des Sechskantmunds ermöglicht Zugang auf engem Raum. Das interne Auslassloch erleichtert das Arbeiten an Muttern mit hervorstehenden Gewindeteilen, insbesondere beim Modell 944BX mit tiefer Buchse.

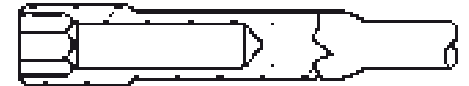

Die dreifache Kennzeichnung am Kopf erleichtert die Erkennung des Maßes.

Der flexible Schaft des Modells 943FL, der aus einem durch einen Mantel geschützten Stahlkern besteht, ermöglicht die Drehmomentübertragung auch bei Nichtausrichtung mit der Schraube.

942BX

Sechskant-Steckschlüssel kurze Ausführung



UNI 6750

4 190 mm 70 mm 13,0 mm 16,30 € 5 009420003

5 190 mm 70 mm 14,0 mm 16,30 € 5 009420004

5,5 190 mm 70 mm 12,5 mm 18,40 € 5 009420005

6 190 mm 70 mm 14,5 mm 18,40 € 5 009420006

7 190 mm 70 mm 15,5 mm 19,30 € 5 009420007

8 202 mm 70 mm 18,5 mm 19,30 € 5 009420008

9 202 mm 70 mm 19,5 mm 19,30 € 5 009420009

10 202 mm 70 mm 20,5 mm 20,50 € 3 009420010

11 202 mm 70 mm 21,5 mm 20,50 € 3 009420011

12 202 mm 70 mm 22,5 mm 20,50 € 3 009420012

13 202 mm 70 mm 23,5 mm 23,20 € 3 009420013

14 202 mm 70 mm 24,5 mm 23,20 € 3 009420014



942BX/S12 234,00 € 1 009420030

4-5-5,5-6-7-8-9

10-11-12-13-14 mm

943BX

Sechskant-Steckschlüssel
lange Ausführung

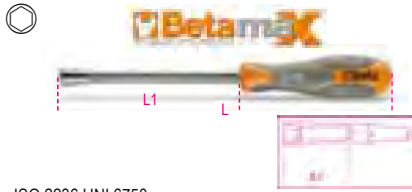

ISO 2236 UNI 6750

Ø mm	L mm	L1 mm	A1 mm	€	U	PC
4	270	150	13,0	18,10	5	009430003
5	270	150	14,0	18,10	5	009430004
5,5	270	150	12,5	19,40	5	009430005
6	270	150	14,5	19,40	5	009430006
7	270	150	15,5	20,70	5	009430007
8	282	150	18,5	20,70	5	009430008
9	282	150	19,5	20,70	5	009430009
10	282	150	20,5	22,60	3	009430010
11	282	150	21,5	22,60	3	009430011
12	282	150	22,5	22,60	3	009430012
13	282	150	23,5	24,10	3	009430013
14	282	150	24,5	24,10	3	009430014



943BX/S12 252,00 € U PC 1 009430030
4-5-5,5-6-7-8-9
10-11-12-13-14 mm



943BX/D6 125,00 € U PC 1 009430026
5-6-7-8-10-13 mm

943FL

Flexible Sechskant-Steckschlüssel
mit Griff



Ø mm	L mm	L1 mm	Ø mm	€	U	PC
5	265	150	8	25,50	2	009430304
5,5	265	150	8	25,50	2	009430305
6	265	150	9	25,50	2	009430306
7	265	150	11	25,50	2	009430307
8	265	150	12	26,50	2	009430308
10	290	175	14	28,50	2	009430310



943FL/S6 156,00 € U PC 1 009430320
5-5,5-6-7-8-10 mm

944BX

Tiefe Sechskant-Steckschlüssel
lange Ausführung

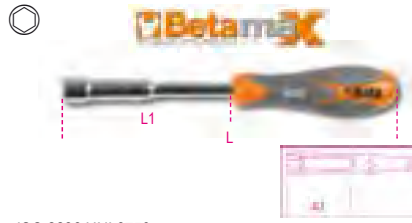

ISO 2236 UNI 6750

Ø mm	L mm	L1 mm	A1 mm	€	U	PC
4	245	125	20	18,70	3	009440003
5	245	125	25	18,70	3	009440004
5,5	245	125	30	22,90	3	009440005
6	245	125	35	22,90	3	009440006
7	245	125	35	22,90	3	009440007
8	257	125	50	24,60	3	009440008
9	257	125	50	24,60	3	009440009
10	257	125	50	25,50	3	009440010
11	257	125	50	25,50	3	009440011
12	257	125	50	28,00	3	009440012
13	257	125	55	28,00	3	009440013
14	257	125	55	28,00	3	009440014



944BX/S12 290,00 € U PC 1 009440062
4-5-5,5-6-7-8-9
10-11-12-13-14 mm



944BX/D6 142,50 € U PC 1 009440056
5-6-7-8-10-13 mm

949

Sechskant-Steckschlüssel mit T-Griff



Ø mm	L mm	L1 mm	A1 mm	€	U	PC
8	220	160	50	34,00	2	009490008
10	230	160	50	36,00	2	009490010
12	240	175	50	37,00	2	009490012
13	244	175	55	38,00	2	009490013
14	250	190	55	40,50	2	009490014
17	264	200	60	46,50	2	009490017



949/S6 231,00 € U PC 1 009490076
8-10-12-13-14-17 mm

950

Sechskant-Steckschlüssel mit T-Griff

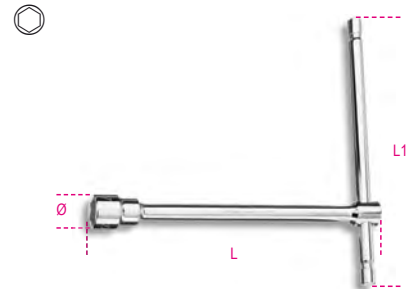

UNI 6742 DIN 3112

Ø mm	L mm	Ø mm	L1 mm	€	U	PC
6	210	10,1	145	23,60	3	009500006
7	212	11,2	145	23,60	3	009500007
8	220	12,4	160	25,50	3	009500008
9	223	13,5	160	25,50	3	009500009
10	230	14,9	160	27,50	3	009500010
11	233	16,1	160	27,50	3	009500011
12	240	17,5	175	30,00	3	009500012
13	244	19,7	175	30,00	3	009500013
14	250	20,1	190	34,00	3	009500014
15	254	21,5	190	36,00	3	009500015
16	260	22,7	200	39,00	3	009500016
17	264	24,1	200	40,50	3	009500017
19	274	26,6	230	50,00	3	009500019
22	290	29,9	290	60,00	2	009500022
24	300	32,2	320	67,50	2	009500024
27	315	36,2	370	80,00	2	009500027



950/S9 288,00 € U PC 1 009500079
7-8-10-11-12
13-14-17-19 mm

950/S14 472,00 € U PC 1 009500082
6-7-8-9-10-11-12-13
14-15-16-17-19-22 mm



951 TIFTSCHLÜSSEL MIT T-GRIFF, AUSSENVIERKANTPROFIL AN DREI ENDEN



Als dieser Schlüssel im Jahr 1980 entstand, stellte er eine Revolution dar. Der Schlüssel wurde zum Zweck der Bearbeitung an hochfesten Schrauben entwickelt, er bietet eine hohe Betätigungsgeschwindigkeit, Verbindungspräzision mit der Schraube und Einsatzflexibilität. Der Sechskantführungsstab kann nach Bedarf reguliert werden. Die Sechskantenden sind kalibriert, um das höchst mögliche Drehmoment auf die Schraube zu übertragen. Die Länge des Stiels ermöglicht das Anbringen von hohen Drehmomenten an den Schrauben ohne eine übermäßige Kraftbeanspruchung. Dank der kontinuierlichen Fertigungsverbesserungen wird der Schlüssel heute einer Oberflächenbehandlung mittels Sandstrahlen ausgesetzt und die scharfkantigen Innensechskantenden ermöglichen eine bessere Verbindung bzw. Ansatz auch auf abgenutzten Schrauben. Die mit Laser durchgeführte Kennzeichnung erhöht die Widerstandsfähigkeit des Stiels. Das neue Modell 951GP wurde in Zusammenarbeit mit Technikern und Mechanikern aus der MotoGP- und Superbike-Welt entwickelt, um ein schnelleres Ein- und Ausdrehen zu ermöglichen.

951 Stiftschlüssel mit T-Griff, Sechskantprofil an drei Enden



mm	L mm	L1 mm	Ø mm	€		
2	125	63	4,0	21,60	5	009510521
2,5	150	63	4,0	21,60	5	009510525
3	150	63	4,0	21,60	5	009510530
3,5	175	76	5,5	22,30	5	009510535
4	175	76	5,5	22,30	5	009510540
4,5	195	87	6,5	24,40	5	009510545
5	195	87	6,5	24,40	5	009510550
6	215	99	8,0	28,00	5	009510560
7	230	109	9,0	30,00	5	009510570
8	250	122	10,0	30,00	5	009510580
9	265	132	11,0	38,00	5	009510590
10	280	142	12,0	38,00	5	009510610
12	305	160	15,0	51,50	3	009510620
14	330	178	17,0	61,50	3	009510640



	€		
951/S6 2,5-3-4-5-6-8 mm	148,00	1	009510687
951/S8 2-2,5-3-3,5-4-4,5-5-6 mm	186,00	1	009510693
951/S14 2-2,5-3-3,5-4-4,5-5-6-7-8-9-10-12-14 mm	435,00	1	009510695



	€		
951/SP6 3-4-5-6-8-10 mm	188,50	1	009510696
951/SPV	34,50	1	009510697



951AS Stiftschlüssel mit T-Griff, Sechskantprofil an drei Enden

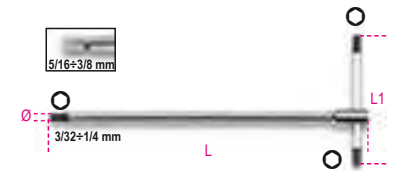

"	L mm	L1 mm	Ø mm	€		
3/32	125	63	4,0	29,50	2	009510750
7/64	150	63	4,0	29,50	2	009510751
1/8	150	63	4,0	29,50	2	009510752
9/64	175	76	5,5	30,00	2	009510753
5/32	175	76	5,5	30,00	2	009510754
3/16	195	86	6,5	33,00	2	009510755
7/32	215	99	8,0	33,00	2	009510757
1/4	230	109	9,0	37,50	2	009510758
5/16	250	122	10,0	38,00	2	009510759
3/8	280	142	12,0	46,50	2	009510760

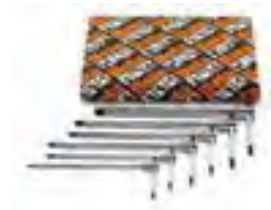

	€		
951AS/S6X 1/8-3/16-7/32-1/4-5/16-3/8	216,50	1	009510771

951GP

Stiftschlüssel mit T-Griff, Sechskantprofil an einem Ende

Der Stiftschlüssel Beta 951GP ermöglicht ein schnelles Manövrieren und präzises Ankoppeln an die Schraube. Entwickelt, um einige rennsportspezifische Problematiken zu lösen. Hohe Drehmomente ermöglichen ein schnelles Verschrauben.

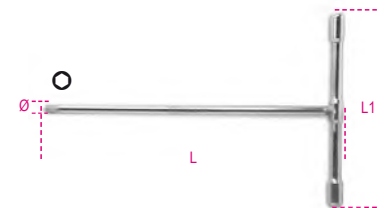

mm	L mm	L1 mm	Ø mm	€		
3	185	130	5	22,00	3	009511530
4	214	150	5	23,00	3	009511540
5	240	165	6	26,00	3	009511550
6	271	180	7	30,00	3	009511560
8	300	200	10	39,00	3	009511580
10	310	200	12	48,00	3	009511610



	€		
951GP/S6 3-4-5-6-8-10 mm	184,00	1	009511687

951TX

Stiftschlüssel mit T-Griff,
Außenvierkantprofil an drei Enden,
für Torx®-Schrauben



Ø	L mm	L1 mm	Ø mm	€	U	PC
T6	125	63	4	27,00	3	009510806
T7	125	63	4	27,00	3	009510807
T8	125	63	4	28,00	3	009510808
T9	125	63	4	28,00	3	009510809
T10	150	63	4	28,00	3	009510810
T15	150	63	4	28,00	3	009510815
T20	175	76	5	30,00	3	009510820
T25	175	76	5	30,00	3	009510825
T27	195	87	6	32,00	3	009510827
T30	195	87	6	32,00	3	009510830
T40	215	99	7	36,50	3	009510840
T45	230	109	8	38,50	3	009510845
T50	250	122	9	41,50	3	009510850

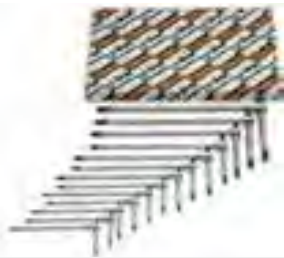

951TX/S6	174,00	1	009510866
T8-T10-T15-T20-T25-T30			
951TX/S13	402,00	1	009510863
T6-T7-T8-T9-T10-T15-T20-T25 T27-T30-T40-T45-T50			

952 SECHSKANT- GELENKSTECKSCHLÜSSEL MIT T-GRIFF

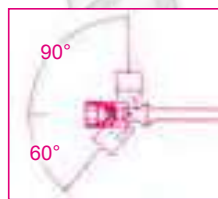
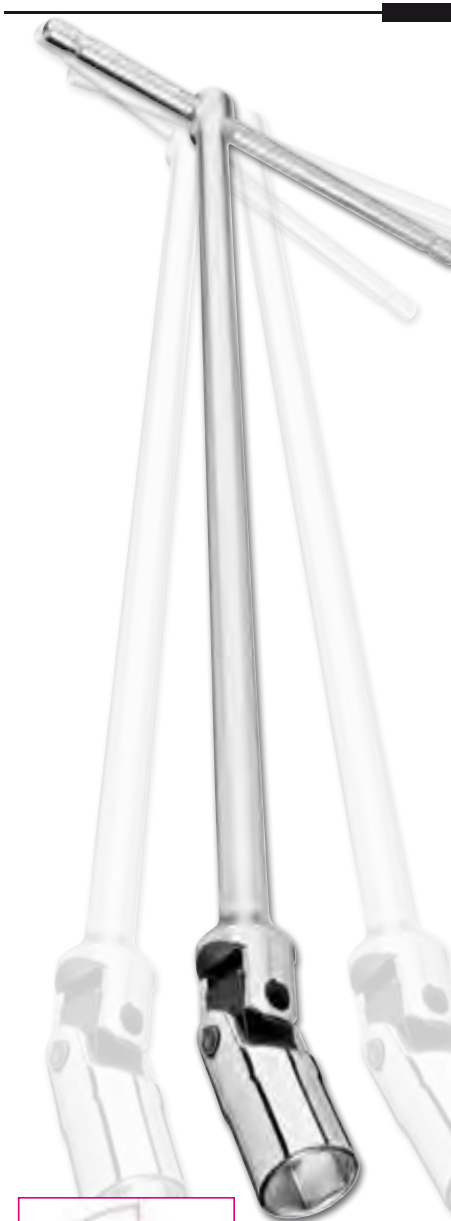

Die Zuverlässigkeit und die Präzision der Vorpositionierung ist der Schlüssel zum Erfolg dieses Schlüssels. Das Gelenk bewahrt auch im Laufe der Jahre seine Funktion, ohne jegliche Einstellung.

Drehwinkel des Steckschlüssels: 60°. Mögliche Nutzung mit 90° in fester Position. Betätigungsstange, die in der gewünschten Position auf der ganzen Länge angehalten werden kann. Dreifache Größenzeichnung am Kopf.

952

Sechskant-Stiftschlüssel mit T-Griff

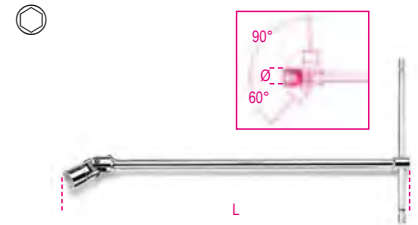

UNI 6743

Ø mm	Ø mm	L mm	€	U	PC
6	9,5	395	36,50	5	009520006
7	10,7	395	36,50	5	009520007
8	12,1	395	36,50	5	009520008
9	13,2	395	36,50	5	009520009
10	14,6	400	39,00	5	009520010
11	15,8	400	39,00	5	009520011
12	17,0	400	39,00	5	009520012
13	18,7	432	42,50	5	009520013
14	19,7	432	42,50	5	009520014
15	20,9	450	51,50	3	009520015
16	22,0	450	51,50	3	009520016
17	23,4	450	51,50	3	009520017
18	24,7	450	51,50	3	009520018
19	26,0	500	62,50	3	009520019
20	27,4	500	62,50	3	009520020
21	28,5	500	62,50	3	009520021
22	29,7	500	62,50	3	009520022
24	32,4	500	62,50	3	009520024



952/S7	312,00	1	009520074
8-10-11-13-14-17-19 mm			
952/S10	439,00	1	009520080
7-8-10-11-12-13- 14-15-17-19 mm			
952/S18	864,00	1	009520083
6-7-8-9-10-11-12 13-14-15-16-17 18-19-20-21-22-24 mm			



952/D7	286,00	1	009520079
7-8-10-12-13-14-17 mm			

852



852 1/4

79,85

952AS

Sechskant-Gelenksteckschlüssel mit T-Griff

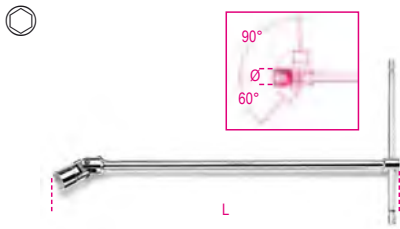

Ø mm	Ø mm	L mm	€		
1/4	9,5	395	39,50	2	009520256
5/16	12,1	395	39,50	2	009520258
3/8	14,6	400	43,00	2	009520260
7/16	15,8	400	43,00	2	009520261
1/2	18,7	432	48,00	2	009520263
9/16	19,7	432	51,50	2	009520264
5/8	22,0	450	55,00	2	009520266
11/16	23,4	450	55,00	2	009520267
3/4	26,0	500	68,00	2	009520269

952L

Sechskant-Gelenkkopf-Steckschlüssel mit T-Griff, lange Ausführung

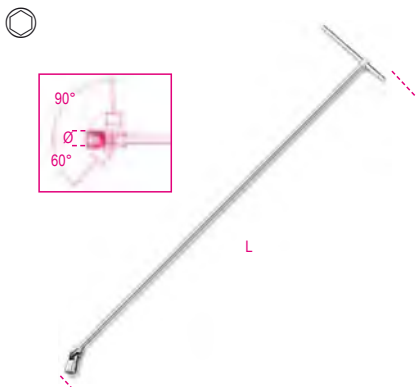

Ø mm	Ø mm	L mm	€		
10	14,6	930	99,50	1	009520410
12	17,0	1063	99,50	1	009520412
13	18,7	1100	99,50	1	009520413
14	19,7	1100	99,50	1	009520414
15	20,9	1100	111,50	1	009520415
16	22,0	1100	111,50	1	009520416
17	23,4	1100	111,50	1	009520417
18	24,7	1100	111,50	1	009520418
19	26,0	1100	129,50	1	009520419



952FTX

Gelenkkopf-Steckschlüssel mit T-Griff, für Torx®-Schrauben

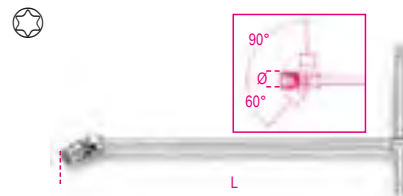

Ø mm	L mm	€		
E6	8	392	43,00	2 009520106
E7	9	392	43,00	2 009520107
E8	10	395	49,00	2 009520108
E10	13	400	50,50	2 009520110
E12	15	440	60,50	2 009520112
E14	17	490	74,00	2 009520114
E16	19	490	74,00	2 009520116
E18	21	490	74,00	2 009520118
E20	23	490	74,00	2 009520120



952FTX/S9	€		
E6-E7-E8-E10-E12 E14-E16-E18-E20	539,00	1	009520141

953

Gelenkkopf-Stiftschlüssel mit T-Griff, Sechskantprofil

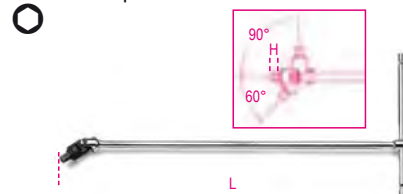

UNI 6754

mm	H mm	L mm	€		
3	5	395	37,50	5	009530130
3,5	6	395	37,50	3	009530135
4	6	395	37,50	5	009530140
4,5	7	395	37,50	3	009530145
5	7	395	37,50	5	009530150
6	9	400	40,50	5	009530160
7	10	425	44,50	3	009530170
8	11	425	44,50	5	009530180
10	13	440	53,00	5	009530200



953/S5	€		
3-4-5-6-8 mm	197,00	1	009530305
953/S9	370,00	1	009530301
3-3,5-4-4,5 5-6-7-8-10 mm			

953TX

Gelenkkopf-Stiftschlüssel mit T-Griff, für Torx®-Schrauben

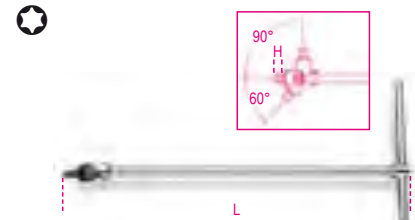

Ø mm	H mm	L mm	€		
T20	11	396	46,00	2	009530020
T25	11	396	46,00	2	009530025
T27	11	396	46,00	2	009530027
T30	13	400	50,50	2	009530030
T40	13	400	50,50	2	009530040
T45	13	426	51,50	2	009530045
T50	14	442	60,50	2	009530050
T55	14	442	61,00	2	009530055



953TX/S8	€		
T20-T25-T27-T30 T40-T45-T50-T55	410,00	1	009530060



KFZ-SPEZIAL

Unsere Kfz-Spezialwerkzeuge, die von den anspruchsvollsten Professionisten verwendet werden, wurden entwickelt und ausgelegt, um die höchsten Weltstandards zu erfüllen. Sie werden kontinuierlich unter schwersten Nutzungsbedingungen getestet. Seit mehr als 50 Jahren sind wir mit Stolz Seite an Seite mit den großen Meistern, die uns dabei helfen, unsere Produkte ständig zu verbessern, und die unsere absolut hohe Qualität bestätigen.

Die Kfz-Spezialwerkzeuge finden Sie in diesen Abschnitten:

Diagnostik	von 1438 bis 1499 von 1758VT bis 1760TMC
Motor	von 955 bis 989A von 1438 bis 1499
Öl und Filter	von 1438 bis 1499 von 1877 bis 1885
Electric system	von 1438 bis 1499
Anlasser	von 1498BC/12 bis 1498/40A
Getriebe	von 1438 bis 1499
Radaufhängungen	von 1549 bis 1569CP
Bremsen	von 1438 bis 1499
Bereifung	von 955 bis 989A
Karosserie	von 1302 bis 1369 von 1763 bis 1767A
Weitere Einrichtungen	von 1875LT bis 3067
Heben	von 3029/2T bis 3067/70-13T



955 Zündkerzen-Rohrsteckschlüssel

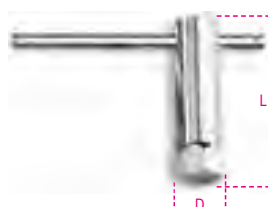

mm -"	D mm	L mm	€	U	U
16 5/8	21	86	18,60	3	009550016
20,8 13/16	29	86	18,60	3	009550021

956C Zündkerzeneinsätze mit Innenvierkanttrieb 1/2"



ISO 11168

mm -"	Ø mm	L mm	€	U	U
14 9/16	18,8	70	34,50	3	009560008
16 5/8	21,4	70	34,50	3	009560010
17,8 11/16	23,6	70	34,50	3	009560011
20,8 13/16	27,0	70	34,50	3	009560012

956E Zündkerzeneinsätze mit Innenvierkanttrieb 3/8"



ISO 11168

mm -"	Ø mm	L mm	€	U	U
14 9/16	18,8	70	38,00	3	009560018
16 5/8	21,4	70	38,00	3	009560020
17,8 11/16	23,6	70	38,00	3	009560021
20,8 13/16	27,0	70	38,00	3	009560022

956F Zündkerzeneinsätze mit Innenvierkanttrieb 3/8"



mm -"	Ø mm	L mm	€	U	U
14 9/16	18,8	70	43,00	1	009560114
16 5/8	20,5	70	52,50	1	009560116

Beta

956L Zündkerzeneinsätze mit Innenvierkanttrieb 1/2", Zwölfkantprofil, lange Ausführung



mm -"	Ø mm	L mm	€	U	U
14 9/16	19,0	250	71,00	2	009560214
16 5/8	21,0	250	73,00	2	009560216
17,8 11/16	24,0	250	77,00	2	009560217

957 Zündkerzenschlüssel mit Gelenk

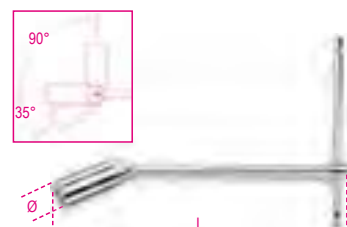

ISO 11168

mm -"	Ø mm	L mm	€	U	U
16 5/8	21,4	275	53,00	3	009570000
20,8 13/16	27,0	275	62,50	3	009570001

959

Zündkerzenschlüssel mit Gelenk, normale Ausführung



ISO 11168

mm - "	Ø mm	L mm	€		
14	18,8	483	62,00	3	009590009
9/16					
16	21,4	483	68,50	3	009590010
5/8					
20,8	27,0	527	91,50	3	009590011
13/16					

959R

Gummi und Ersatzfeder für Art. 956C - 956E - 957 - 959

	€		
959R/14 956C/14-956E/14	6,50	3	009590223
959R/16 956C/16-956E/16 957/16-959/16	6,50	3	009590224
959R/17,8 956C/17,8-956E/17,8	6,50	3	009590225
959R/20,8 956C/20,8-956E/20,8 957/20,8-959/20,8-959L	6,50	3	009590226

960

Steckschlüssel mit Innenvierkantantrieb 1/2", für Dieseleinspritzmotoren

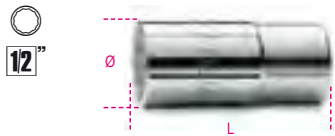

mm	Ø mm	L mm	€		
27	36,5	77	40,00	2	009600027

960A

Steckschlüssel mit Innenvierkantantrieb 1/2", für Dieseleinspritzmotoren



mm	Ø mm	L mm	€		
27	36,5	77	58,50	2	009600017

960BC/C5

Steckschlüsselsatz, 5-teilig, zur elektrischen Verbindung der Einspritzdüsen

Satzinhalt:

- 1 offener Sechskant-Steckschlüssel 25 mm
- 1 offener Sechskant-Steckschlüssel 27 mm
- 1 offener Sechskant-Steckschlüssel 29 mm
- 1 offener Sechskant-Steckschlüssel 30 mm
- 1 Zwölfkant-Steckschlüssel 28 mm



960BC/C5	€		
	181,00	1	009600280

280x160x55 mm - 1,9 kg

960ER

Gleithammer für Scheiben von Einspritzdüsen

Mehrfasenstufenbohrer

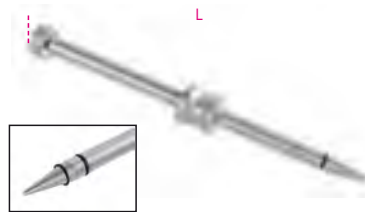

L mm	€		
350	72,00	1	009600726

960F

Steckschlüssel für Einspritzdüsen-Nutmuttern



Ø mm	Ø1 mm	1 mm	2 mm	€		
28,3	22	32	22	46,50	1	009600148

960G

Steckschlüssel für Nutmuttern, speziell für Dieseleinspritzungen von Mercedes-Benz-LKW



Ø mm	Ø1 mm	mm	L mm	€		
28,5	22	32	122	49,00	1	009600151

960L

Steckschlüssel für Einspritzdüsen-Nutmuttern



Ø mm	Ø1 mm	L mm	€		
30	22	122	53,00	1	009600153

960M

Steckschlüssel für Einspritzdüsen-Nutmuttern

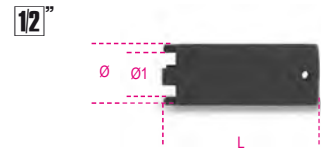

Ø mm	Ø1 mm	L mm	€		
28,5	22	72	39,00	1	009600154

960H/C4

Steckschlüsselsatz für Einspritzdüsen-Nutmuttern



960H/C4	€		
	141,00	1	009600152

960SL

Steckschlüssel für Lambdasonden, mit Innenvierkantantrieb 1/2"



	Ø mm	€		
960SL 85	33	69,50	2	009600085
□ 22xL= 85 mm				
960SL 110	33	79,00	2	009600110
□ 22xL= 110 mm				

960SN

Glühkerzenschlüssel für Dieselmotoren



mm	Ø mm	mm	L mm	€		
8	12,0	1/4	60	59,00	2	009600834
9	13,3	1/4	60	59,00	2	009600835
10	14,5	3/8	70	70,50	2	009600836

960T/C11

Steckschlüsselsortiment zum Ein-/Ausbau von Sensoren

Im Kit enthalten sind:

- 1 Doppel-Sechskant-Steckschlüssel, Maße 1" - 1 1/16" für Öldrucksensoren
- 1 offener Sechskant-Steckschlüssel 29 mm für Lambdasonden
- 1 offener Zwölfkant-Steckschlüssel 27 mm für Injektoren
- 1 offener Sechskant-Steckschlüssel 22 mm für Unterdruckschalter
- 1 offener Sechskant-Steckschlüssel 22 mm, 80 mm lang, für Lambdasonden
- 1 offener Sechskant-Steckschlüssel 22 mm, 90 mm lang, für Lambdasonden
- 1 offener Sechskant-Steckschlüssel 22 mm, kompakt und 30 mm lang, für Lambdasonden
- 1 offener Sechskant-Steckschlüssel 22 mm kompakt und 50 mm lang, für Lambdasonden
- 1 offener Steckschlüssel 22 mm kompakt und 34 mm lang, mit Sechs-/Zwölfkantprofil, für Lambdasonden
- 1 offener Sechskant-Steckschlüssel 22 mm mit Rohrgeometrie
- 1 Gewindebohrer M18x1,5



22 - 29 mm

960T/C11 232,00 € 1 009600031

330x270x25 mm

960T/A

Offener Sechskant-Steckschlüssel 29 mm für Lambda-Sonden



29 mm 90 mm 27,50 € 1 009600032

960T/B

Offener Zwölfkant-Steckschlüssel 27 mm für Injektoren



27 mm 85 mm 24,00 € 1 009600033

960T/C

Offener Sechskant-Steckschlüssel 22 mm für Unterdruckschalter

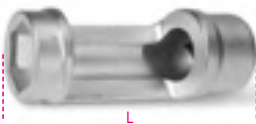

22 mm 88 mm 21,10 € 1 009600034

960T/F

Doppel-Sechskant-Steckschlüssel, Maße 1" - 1 1/16" für Öldrucksensoren



1 - 1 1/16" 28 mm 74 mm 16,60 € 1 009600037

960T/G

Offener Sechskant-Steckschlüssel 22 mm mit Rohrgeometrie



22 mm 25 mm 98 mm 47,00 € 1 009600038

960T/H

Offener Steckschlüssel 22 mm, kompakt, 34 mm lang, mit Sechs-/Zwölfkantprofil, für Lambda-Sonden



22 mm 34 mm 55 mm 17,60 € 1 009600039

960/22EP

Doppelform-Gelenkschlüssel für Lambda-Sonden

Vielseitige Anwendbarkeit dank der Sechskant/Zwölfkant und dem 180°-Gelenk



300 mm 22 mm 22 mm 63,00 € 1 009600052

960/C6

Sechskantschlüssel mit Innensechskant 3/8" für Entfernen/Installation von Abgastemperatursensoren

Inhalt des Kit:

- 3 Maße in kurzer Version 13, 14, 17 mm
- 3 Maße in langer Version 13, 14, 17 mm



960/C6 97,50 € 1 009600055

170x120x50 mm

960/D

Offene Sechskantschlüssel, lange Version, für Aus-/Einbau von Abgastemperatursensoren



13 mm 15,20 € 1 009600073
14 mm 15,20 € 1 009600074
17 mm 18,30 € 1 009600077

960YP

Offene Sechskantschlüssel, Version gebogen, für Aus-/Einbau Abgastemperatursensoren

38



mm	€	1	009600063
13	16,10	1	009600063
14	16,70	1	009600064
17	22,30	1	009600067

960AVE

Prüfwerkzeug Elektroinspritzventile Diesel Common Rail



960AVE	€	1	009600245
	312,00	1	009600245

300x310x50 mm - 2,0 kg

960EPC/L

Werkzeugsatz zum Abziehen der Elektroden Spitze der Glühbirnen M8x1 - M9x1 - M10x1 - M10x1,25



ZONA DI ROTTURA

960EPC/L	€	1	009600890
	1.024,00	1	009600890

270x230x80 mm - 2 kg

960E-PI/P

Ausziehwerkzeug für Scheiben von Einspritzdüsen

• Außengewinde M10 zur Verwendung mit Gleithammer (Beta 1540)



960E-PI/P	€	1	009600706
	80,50	1	009600706

300x90x60 mm

960KC-M8/M9/M10

Werkzeugsortiment zum Ausbau von gebrochenen oder beschädigten Glühkerzen

• Für Kerzen mit Gewinde M8-M9-M10



960KC-M8/9/10	€	1	009600801
	518,00	1	009600801

380x290x50 mm - 2,3 kg

960KPC

Glühkerzen-Vibro-Ausdreher, rechts- und linksdrehend, mit einstellbarem Drehmoment
4 einstellbare Anzugsmomente:
10-20-30-40 Nm

14

CE



960KPC	€	1	009600780
	373,00	1	009600780

8-9-10-11-12 mm
420x185x60 mm - 2,8 kg

960UC

Werkzeugsatz zum Abziehen von blockierten Glühkerzen mit verbogener Spitze M8-M9-M10



960UC	€	1	009600900
	594,00	1	009600900

270x230x80 mm - 2,6 kg

960P

Testgerät für Druck-/Unterdruckkontrolle mit Zubehör und Adaptern



960P	€	1	009600777
	308,00	1	009600777

350x320x95 mm - 1,9 kg

960PI

Bohrersortiment für die Reinigung von Einspritzventilsitzen im Kunststoffkasten

Zur Reinigung von Rückständen in den Einspritzventilsitzen
- Flachbohrer Ø 19 - 15 mm für Universal-Einspritzdüsen
- Flachbohrer Ø 17 - 17 mm für Einspritzdüsen Delphi/Bosch (BMW/PSA/Renault/Ford)
- Flachbohrer Ø 19 - 17 mm für Einspritzdüsen Bosch (Mercedes CDI).
- Winkelbohrer Ø 21 - 17 mm für Einspritzdüsen Fiat/Iveco.
- Griff



960PI	€	1	009600215
	144,00	1	009600215

250x130x50 mm - 600 g

960PI/C19

Sortiment 19 Werkzeuge
für die Reinigung von Einspritzventilsitzen

Kitinhalt:

- 11 Flachbohrer Ø:
14/14 mm - 15,5/15,5 mm - 15/19 mm - 17/19 mm - 17/17,5 mm
17/19 mm - 17/19,5 mm - 17/20 mm - 18/21 mm - 19 mm -
20/21 mm
- 4 Winkelbohrer Ø:
15,5/15,5 mm - 17/17 mm - 17,5/20,5 mm - 17/21 mm
- Griff und Zubehör für die Verwendung der Reibahlen



960PI/C19 € 359,00 1 009600217
360x230x60 mm

960PI/K36

Bürstenset zur Reinigung
der Einspritzdüsen

1/4



DIN 3126 E6,3

960PI/K36 € 226,00 1 009600218
350x255x74 mm 1253 g

960PI/S

Kit zur Reinigung der Einspritzdüsen

Kitinhalt:

- 3 Stahlbürsten Ø 18, 22, 25 mm für die Reinigung von
Einspritzdüsen
- 2 Bürsten Ø 14 und 16 mm für die Reinigung des Bodens der
Einspritzdüsen
- 6 Stöpsel zum Verschließen des Verbindungslochs
Brennraum
- 1 Flaschenbürste für die Reinigung des Verbindungslochs
Brennraum
- 1 flexibler Einsatzhalter mit Griff

1/4



960PI/S € 190,00 1 009600214
360x140x50 mm 700 g

960VTC

Prüfgerät für Zylinderdichtigkeit an
Benzinmotoren

Nach dem Einführen von Druckluft in den Zylinder kann
anhand des Manometers überprüft werden, ob die
Kompression eventuell nachlässt



960VTC € 330,00 1 009600261
373x295x70,6 mm 2,3 kg

960RPI

Blaswerkzeug für Reinigung Injektorsitz

Für Motoren mit Glühkerzen

M8x1 - M9x1 - M10x1 - M10x1.25



960RPI € 229,00 1 009600940

960PMC

Austarierpumpe
für Dieseleinspritzdüsen



Bar Max. € 902,00 1 009600200
600

961P6

Elektronisches Videoskop mit Schlauchsonde



CE

- Unterstützt die Verwendung der SD CARD (8 GB)
- Unterstützt Flash-Speicher (8 GB)
- Interner Speicher von 128M
- Ausgang TV-OUT
- Unterstützt Videoformate (MP4, AVI, 3GP)
- 4 Leucht-LED
- Versorgung über USB-Stecker (eingebaute Batterie)

TECHNISCHE MERKMALE

- Pixel des Sensors: 640x480
- Max. Auflösung: 320x240
- Sondenlänge: 1 m
- Kameradurchmesser: 6 mm
- Videoformate: MPEG4, 3GP, AVI, ASF
- Fotoformate: JPEG
- Aufnahmewinkel: 0÷180°
- Datenausgang: USB-Kabel und SD-Card
- Versorgung: Batterie 3,7V 2000 mAh

961P6 € 888,00 1 009610000

961P6/S

Schlauchsonden, 6 mm



IP67	L mm	€	1	009610006
961P6/S 1	1000	385,00	1	009610006
961P6/S 2	2000	430,00	1	009610262
961P6/S 3	3000	486,00	1	009610263

962

Montierhebel



L mm	A mm	€	1	009620003
300	21	28,50	5	009620003
400	25	34,00	5	009620004
500	27	44,50	3	009620005
600	27	57,50	3	009620006

962C



962C 277

962P

Reifenheber mit kratzfestem Gummischutz



L mm	A mm	€	Stk	Art-Nr
490	25	108,00	1	009620049

962M

Werkzeug zur Demontage/Montage von Reifen

besonders geeignet für Runflat und Modelle mit tief gesetzten Schultern

- Kratzfeste Krallen für Blockierung an den Felgen
- Aufnahme zum Einführen des Reifenmontierhebels



962M	€	Stk	Art-Nr
	385,00	1	009620501

963

Hebeleisen, gerade



L mm	A mm	€	Stk	Art-Nr
400	23	44,00	5	009630001

964

Hebeleisen, gebogen



L mm	A mm	€	Stk	Art-Nr
400	46	39,50	5	009640001

965

Hebeleisen mit Griff



L mm	A mm	L1 mm	€	Stk	Art-Nr
300	16	185	20,20	2	009650013
450	20	312	28,50	2	009650014
600	20	462	33,50	2	009650016



965/S3	€	Stk	Art-Nr
	82,00	1	009650019

966/C3

Hebeleisensatz, 3teilig, mit breitem und gebogenem Gelenkkopf



966/C3	€	Stk	Art-Nr
L=200-250-300 mm	152,00	1	009660103
355x140x65 mm - 1,8 kg			

720LS

Kraftsteckschlüssel
lange, schmale Ausführung



720LS 36	Ø mm	L mm	Ø1 mm	€	Stk	Art-Nr
	36	48,0	78	29	2	007200386

969B

Steckschlüssel zum Anziehen von Radnabenmuttern

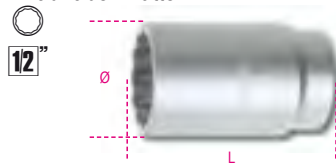

969B	Ø mm	L mm	€	Stk	Art-Nr	
	24	36,0	76	26,00	1	009690124
	27	36,0	76	26,50	1	009690127
	30	40,0	76	27,00	1	009690130
	31	42,0	76	28,00	1	009690131
	32	42,5	76	30,00	1	009690132
	34	45,0	76	33,00	1	009690134
	35	46,0	76	33,50	1	009690135
	36	49,0	76	38,50	1	009690136

969/C5

Steckschlüsselsatz, 5teilig,
zum Anziehen von Radnabenmuttern
im Kunststoffkoffer



969/C5	€	Stk	Art-Nr
	162,00	1	009690201

969B 30-32-34-35-36

970B

Steckschlüssel zum Anziehen von Radmuttern Fiat Daily



970B	Ø mm	L mm	€	Stk	Art-Nr	
	65	88	75	126,00	1	009700010

970IVECO

Haken-Steckschlüssel
für Radmuttern Iveco Daily
Für Modelle ab 2014

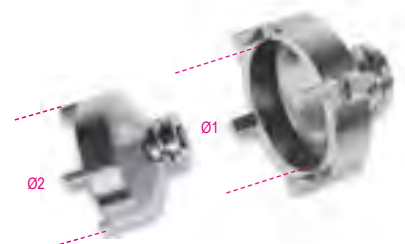

970IVECO	Ø1 mm	Ø2 mm	€	Stk	Art-Nr
	61,5	74,8	75,50	1	009700011



971/C8

Drehmomentschrauber mit Zubehör für kontrolliertes Festziehen von Reifenventilen mit Druckkontrollsystem



971/C8 € 477,00 1 009710108

	583/6	1,2÷6 Nm
	892/0	
	862TX	T10-T15-T20
	900L	11-12 mm
	986 78	

972/C4BMW

Satz zum Entfernen von diebstahlsicheren Schrauben mit freiem Ring, für Fahrzeuge BMW und Mini



972/C4 BMW € 275,00 1 009720004

516x145x66 mm - 3,8 kg

972/C10

Satz zum Entfernen von beschädigten Radmuttern
Verwendbar an diebstahlsicheren und herkömmlichen Muttern



972/C10 € 348,00 1 009720010

290x250x60 mm - 2,4 kg

973

Kit 4 Reifenabdeckungen aus Nylon

Geeignet für die folgenden Reifen:
14" bis 18" Artikelnr. 009730014
19" bis 22" Artikelnr. 009730019



- Schützt das Rad vor eventuellen Kratzern und Staub
- Während der Einlagerung wird der vorzeitige Verschleiß der Gummipolymeren des Sommer- oder Winterreifens verhütet
- Mittels eines Kennzeichnungs-Icons kann die Radposition schnell ermittelt werden (vorne rechts/links oder hinten rechts/links)
- Mit Handgriff ausgestattet für einen praktischen Transport
- Gewebe: Nylon, waschbar

973 14-18 € 122,00 1 009730014
973 19-22 € 135,00 1 009730019

978 - 979

Kreuzschlüssel für Radmuttern

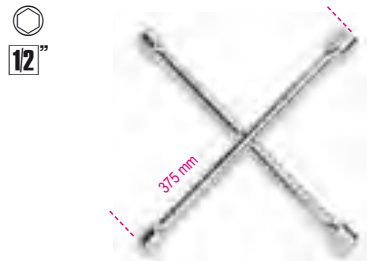

UNI/ISO 6788 DIN 3119

978 € 77,00 2 009780001
17x19x21x22 mm
979 € 77,00 2 009790001
17x19x22x1/2 mm

982

Kreuzschlüssel für Radmuttern

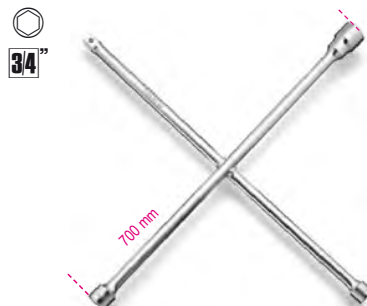

UNI/ISO 6788 DIN 3119

24x27x32x3/4 mm € 187,00 1 009820001

983PM

Schleifbürste zur Nabenreinigung



Ø1 90 mm € 90,00 1 009830010
Ø2 150 mm

983 PM/R-DA

Schleifscheiben, Paar, für Art. 983PM



Ø 150 mm € 83,00 1 009830050

984

Zange für Kunststoffabdeckungen Radmuttern



L 195 mm H 4 mm € 30,50 1 009840005

985/B7

Sortiment von 7 Führungsbolzen für Rädermontage

- Enthaltene Maße:
- M12x1,25 Stift
 - M12x1,25 Buchse
 - M12x1,5 Stift
 - M12x1,5 Buchse
 - M14x1,25 Stift
 - M14x1,5 Stift
 - M16x1,5 Stift



C985/B7 € 120,00 1 009850007



985M

Führungsstifte für Rädermontage



	L mm	€		
985M M12X1,25	150	15,60	1	009850101
985M M12X1,50	150	15,60	1	009850102
985M M14X1,25	150	16,10	1	009850103
985M M14X1,50	150	16,10	1	009850104
985M M16X1,50	150	17,70	1	009850105

985F

Führungsbolzen für Rädermontage



	L mm	€		
985F M12X1,25	150	20,80	1	009850106
985F M12X1,50	150	22,00	1	009850107

986 48

Schraubendreher für Reifenventile,
kurze Ausführung

Automatische Ventiltrückhaltung



L mm	L1 mm	€		
18	48	17,70	1	009860048

986 78

Schraubendreher für Reifenventile

Automatische Ventiltrückhaltung



L mm	L1 mm	€		
18	78	17,70	1	009860078

986PT

Auf 0,4 Nm vorkalibrierter Schraubenschlüssel
für Reifenventile

Automatische Rückhaltung des Ventils

Der Verschiebemechanismus ermöglicht,
dass die Dichtung des Ventilkerns nicht beschädigt wird



L mm	L1 mm	€		
19	120	62,00	1	009860140

987

Reifenventilheber
mit Gummischutz



L mm	€		
310	36,50	1	009870001

987AR

Hebel für Reifenventile
mit rutschfestem Angelpunkt

- Angelpunkt aus Gummi und Nylon für Felgen aus Legierung und Eisen
- Schnellanschluss des Ventils, braucht nicht angeschraubt zu werden



L mm	€		
305	112,00	1	009870021

987P

Reifenventilheber
aus Kunststoff

Im Griff ist der Schraubendreher zum Arbeiten am
Ventilmechanismus enthalten



L mm	€		
335	30,50	1	009870011

988/K4

Meißelsatz, 4teilig, aus kratzfestem Kunststoff



	€		
988/K4 A= 19-21-25-38 mm	32,50	1	009880104

989

Auswuchtzange



L mm	€		
250	57,50	2	009890001

989A

Zange zum Entfernen von zur
Radauswuchtung eingesetztem Klebeblei



Eigens für das Entfernen des Bleis ohne Berührung des Felgens
entwickeltes Profil der Backen

L mm	€		
989A 220	39,00	1	009890011

989B

Universalzange für
zur Radauswuchtung eingesetzte
Klebebewichte

Funktionen:

- Entfernen von Klebebewichten für Leichtmetallfelgen
- Entfernen von Auswuchtgewichten für Eisenfelgen
- Hammer mit entfernbarer Abdeckung aus PE-HD für Klebeblei und Eisenfelgen
- Backe zum Verschließen von Auswuchtgewichten für Eisenfelgen



L mm	€		
230	74,00	1	009890015



990

Gerade Pinzette mit feinen, abgerundeten Spitzen, gezahnt, aus rostfreiem Stahl, fein poliert



L mm 130 € 14,20 5 009900001

991

Gebogene Pinzette mit feinen, abgerundeten Spitzen, gezahnt, aus rostfreiem Stahl, fein poliert



L mm 130 € 17,10 5 009910001

992

Gerade Pinzette mit Stabilisierstift und feinen, abgerundeten Spitzen, gezahnt, aus rostfreiem Stahl, fein poliert



L mm 150 € 18,00 5 009920001

993

Gebogene Pinzette mit Stabilisierstift und feinen, abgerundeten Spitzen, gezahnt, aus rostfreiem Stahl, fein poliert



L mm 145 € 19,30 5 009930001

993PL

Gebogene Pinzette mit feinen, abgerundeten Spitzen, gezahnt, aus rostfreiem Stahl, mit PVC-Überzug



L mm 150 € 19,30 3 009930010

993G

Gebogene Pinzette mit Stabilisierstift und abgewinkelten, abgerundeten Spitzen, gezahnt, aus rostfreiem Stahl, fein poliert



L mm 160 € 17,70 3 009930030

994

Gerade Pinzette mit starken, abgerundeten Spitzen, gezahnt, aus rostfreiem Stahl, fein poliert



L mm 150 € 14,80 5 009940001

994PL

Gerade Pinzette mit starken, abgerundeten Spitzen, gezahnt, aus rostfreiem Stahl, mit PVC-Überzug



L mm 150 € 17,70 3 009940010

994TF

Gerade Pinzette, nicht magnetisch, säurefest, mit starken, abgerundeten Spitzen, gezahnt, aus rostfreiem Stahl, poliert



L mm 150 € 23,60 3 009940020

996

Gerade Pinzette mit spachtelförmigen Backen, aus rostfreiem Stahl, fein poliert



L mm 150 € 15,70 5 009960001

998

Gerade Pinzette mit starken, gekreuzten Backen, gezahnt, aus rostfreiem Stahl, fein poliert



L mm 155 € 27,00 5 009980001

999

Pinzette, nicht magnetisch, säurefest, mit flachen, abgerundeten Spitzen, aus rostfreiem Stahl, poliert



L mm 115 € 21,50 3 009990011

999A

Pinzette, nicht magnetisch, säurefest, mit sehr spitzen Backen, aus rostfreiem Stahl, poliert



L mm 120 € 18,60 3 009990015

999B

Gerade Pinzette, nicht magnetisch, säurefest, mit schlanken Backen, aus rostfreiem Stahl, poliert



L mm 120 € 19,00 3 009990017

999C

Gerade Pinzette, nicht magnetisch, säurefest, mit Nadelspitzen, aus rostfreiem Stahl, poliert



L mm 110 € 20,80 3 009990019

999D

Abgewinkelte Pinzette, nicht magnetisch, säurefest, mit Nadelspitzen, aus rostfreiem Stahl, poliert



L mm 115 € 22,90 3 009990021

999E

Gebogene Pinzette, nicht magnetisch, säurefest, mit schlanken, sehr spitzen Backen, aus rostfreiem Stahl, poliert



L mm 120 € 20,80 3 009990023

999G

Gerade Pinzette, nicht magnetisch, säurefest, mit Blockiervorrichtung und Nadelspitzen, aus rostfreiem Stahl, poliert



L mm 140 € 20,80 3 009990027

999/B6N

Pinzettensatz, 6-teilig, säurefest und nicht magnetisch



999/B6N € 134,00 1 009990060
999-999A-999B
999C-999D-999E

1002

Selbstblockierende Festhaltezange mit abgerundeten Backen, gezahnt, aus Edelstahl



L mm 160 € 33,50 2 010020001

1008

Flachzangen mit langen Backen, innengeriffelt
Griffe mit zweischichtigem Überzug aus rutschfestem PVC



ISO 5745

L mm 160 L1 mm 51,5 € 30,50 5 010080006

1008BM

Flachzangen mit langen Backen, innengeriffelt, Griffe aus Bimaterial



ISO 5745

L mm 160 L1 mm 51,5 € 37,50 3 010080036

1009

Zangen mit halbrunden Backen, extralang, innengeriffelt, Griffe mit zweischichtigem Überzug aus rutschfestem PVC



ISO 5745

L mm 160 L1 mm 56,5 € 30,50 2 010090006

1009L/A

Zange mit halbrunden Backen, extralang, gerade, innengeriffelt, für besonderen Einsatz
Griffe mit zweischichtigem Überzug aus rutschfestem PVC



L mm 283 L1 mm 80 € 37,50 2 010090008

1009L/B

Zange mit halbrunden Backen, extralang, um 45° gebogen, innengeriffelt, für besonderen Einsatz
Griffe mit zweischichtigem Überzug aus rutschfestem PVC



L mm 273 L1 mm 73 € 38,00 2 010090009

1009L/C

Zange mit halbrunden Backen, extralang, um 90° gebogen, innengeriffelt, für besonderen Einsatz
Griffe mit zweischichtigem Überzug aus rutschfestem PVC



L mm 253 L1 mm 45 € 40,00 2 010090010

1009L/D

Zange mit halbrunden Backen, extralang, gerade, innengeriffelt, mit Doppelgelenk, Griffe mit zweischichtigem Überzug aus rutschfestem PVC



L mm	L1 mm	€	🔧	📦
342	71	45,00	1	010090058

1009L/DP

Zange mit halbrunden Backen, extralang, um 45° gebogen, innengeriffelt, mit Doppelgelenk, Griffe mit zweischichtigem Überzug aus rutschfestem PVC

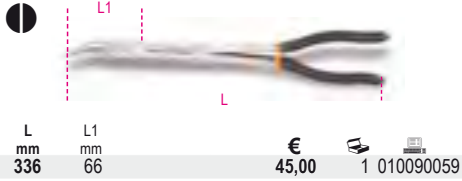

L mm	L1 mm	€	🔧	📦
336	66	45,00	1	010090059

1009L/DP-S2

Zangensatz, 2teilig, mit halbrunden Backen, extralang, innengeriffelt, mit Doppelgelenk



1009L/DP-S2	€	🔧	📦
	89,50	1	010090060

1010

Zangen mit runden Backen, lang, innengeriffelt
Griffe mit zweischichtigem Überzug aus rutschfestem PVC

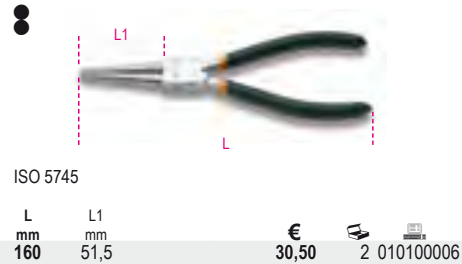

ISO 5745	L mm	L1 mm	€	🔧	📦
	160	51,5	30,50	2	010100006

1010BM

Zangen mit runden Backen, lang, innengeriffelt, Griffe aus Bimaterial

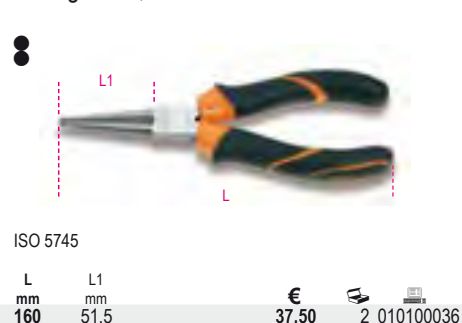

ISO 5745	L mm	L1 mm	€	🔧	📦
	160	51,5	37,50	2	010100036

ZANGEN FÜR SICHERUNGSRINGE (SEEGER-ZANGEN)

PERFEKTE AUSRICHTUNG

Die Tests haben gezeigt, dass die Beta Zangen eine optimale Ausrichtung der Seeger (Sicherungsringe) garantieren, dank der besonderen inversen Konusgeometrie der Spitzen, die nur durch das von Beta eingesetzte Kaltpressen erzielt werden können.



REDUZIERTER SPITZENBRUCH

Die Beta Zangen haben monolithische integrierte Spitzen, die durch Kaltpressen realisiert werden und eine höhere Widerstandsfähigkeit als die Konkurrenten beim Gebrauch und auch bei unbeabsichtigtem Fallen haben.



1031/S4

Zangensatz für Sicherungsringe, 4-teilig



1031/S4	€	🔧	📦
	132,00	1	0103210000

- 1032 180 ○ 19 ÷ 60 mm
- 1034 170 ○ 19 ÷ 60 mm
- 1036 175 ● 19 ÷ 60 mm
- 1038 175 ● 19 ÷ 60 mm

1033

Zangen mit um 45° gebogenen Backen, für Sicherungsringe mit Innenspannung, Griffe mit PVC-Überzug



UNI 7914 DIN 5256

L mm	∅ mm	€	🔧	📦
140x0,9	8÷12	33,00	5	010330013
140x1,3	12÷25	32,50	5	010330014
180	19÷60	33,50	5	010330017
225	40÷100	41,50	3	010330021

1034

Zangen mit um 90° gebogenen Backen, für Sicherungsringe mit Innenspannung, Griffe mit PVC-Überzug



UNI 7914 DIN 5256

L mm	∅ mm	€	🔧	📦
130x0,9	8÷12	33,00	5	010340013
130x1,3	12÷25	32,00	5	010340014
170	19÷60	33,50	5	010340017
210	40÷100	41,50	3	010340021
290	85÷200	58,50	2	010340028

1034L

Zange mit langen, um 90° gebogenen Backen für Sicherungsringe, mit Innenspannung, Griffe mit PVC-Überzug



L mm	∅ mm	€	Hand	PC
190	40÷100	84,50	2	010340320

1036

Zangen mit geraden Backen, für Sicherungsringe mit Außenspannung, Griffe mit PVC-Überzug



UNI 7915 DIN 5254

L mm	∅ mm	€	Hand	PC
140x0,9	3÷10	32,00	5	010360013
140x1,3	10÷25	30,50	5	010360014
175	19÷60	32,50	5	010360017
225	40÷100	40,00	3	010360021
300	85÷200	63,00	2	010360028

1037

Zangen mit um 45° gebogenen Backen, für Sicherungsringe mit Außenspannung, Griffe mit PVC-Überzug



UNI 7915 DIN 5254

L mm	∅ mm	€	Hand	PC
140x0,9	3÷10	35,00	5	010370013
140x1,3	10÷25	33,50	5	010370014
175	19÷60	35,00	5	010370017
225	40÷100	43,50	3	010370021

1038

Zangen mit um 90° gebogenen Backen, für Sicherungsringe mit Außenspannung, Griffe mit PVC-Überzug



UNI 7915 DIN 5254

L mm	∅ mm	€	Hand	PC
135x0,9	3÷10	35,00	5	010380013
135x1,3	10÷25	33,50	5	010380014
175	19÷60	35,00	5	010380017
220	40÷100	43,50	3	010380021
300	85÷200	68,00	2	010380028



1039

Umsteckbare Zange mit geraden Backen, für Sicherungsringe mit Innen- und Außenspannung, Griffe mit PVC-Überzug



L mm	∅ mm	∅ mm	€	Hand	PC
150	10÷15	6÷25	73,50	2	010390015

1558/C4

Werkzeug für Innen- und Außen-Seegerringe mit Schraubenantrieb

Durch den Vierkantantrieb wird bei beiden Betriebsbedingungen eine große Kraft ausgeübt. Mitgelieferte Spitzen: Ø 2,5-3-3,5 mm



1558/C4	∅ mm	∅ mm	€	Hand	PC
5,5 ÷ 77	5,5 ÷ 77		199,00	1	015580100

330x220x50 mm - 900 g

1044N

Verstellbare Zange, phosphatiert, aufgelegtes Gelenk, Griffe mit PVC-Überzug
· Modell mit 8 Positionen



L mm	A max mm	L1 mm	€	Hand	PC
250	46	48	29,00	5	010440025

1047

Verstellbare Zange mit Tasteneinstellung, Griffe mit doppeltem, rutschfestem PVC-Überzug



L mm	A max mm	L1 mm	€	Hand	PC
180	30	29	49,50	2	010470180
240	36	35	53,00	2	010470240
300	50	48	76,50	1	010470300

1047BM

Verstellbare Zange mit Tasteneinstellung, Bimaterial-Griffe



L mm	A max mm	L1 mm	€	Hand	PC
240	36	35	61,00	2	010470340



1048N - POLIGRIP VERSTELLBARE ZANGE MIT DURCHGESTECKTEM GELENK

AUSGEZEICHNETER GRIP UND ÜBERRASCHENDE HANDLICHKEIT

- Geometrie und Zahnwinkel für effektives und sicheres Greifen von sechskantigen und zylindrischen Profilen ausgelegt
- Induktionsgehärtete Zähne für längere Lebensdauer
- Größerer Kopf-Griff-Winkel für eine bessere Ergonomie
- Klemmschutz gegen versehentliches Quetschen der Hand
- Griffe mit innovativem, rutschfestem PVC-Bezug
- Außergewöhnliche Handlichkeit und Komfort dank der vergrößerten Kontaktfläche des Griffs



1048N

Verstellbare Zangen, durchgestecktes Gelenk, Griffe mit Überzug aus rutschfestem PVC

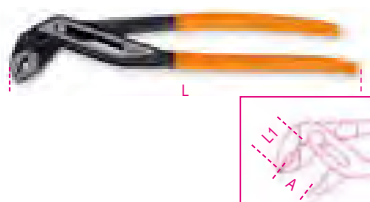

ISO 8976

L mm	A max mm	L1 mm	S mm	€	U	IT
175	36	31	11	31,50	3	010480910
250	46	38	13	33,00	5	010480915
300	60	44	14.8	49,00	2	010480920
400	96	81	19	91,00	1	010480940

1048N/D3

Satz verstellbare Zangen, durchgestecktes Gelenk
Phosphatierter Kopf



L mm	€	U	IT
1048N/D3 175-250-300 mm	113,50	1	010480923

1048BM

Verstellbare Zangen, durchgestecktes Gelenk, Bimaterial-Griffe

• Neues Modell mit neun Positionen



ISO 8976

L mm	A max mm	L1 mm	€	U	IT
250	48	39	52,50	3	010480215

1048VN

Verstellbare Zangen, durchgestecktes Gelenk, orange lackiert

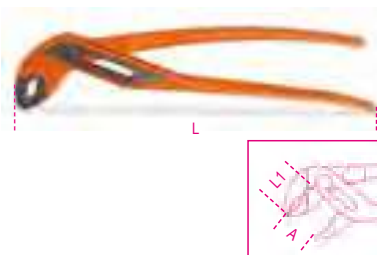

ISO 8976

L mm	A max mm	L1 mm	€	U	IT
175	36	31	31,00	3	010480111
250	46	38	35,50	5	010480116
300	60	44	51,50	2	010480121

1050

Gripzange, zweifach verstellbar

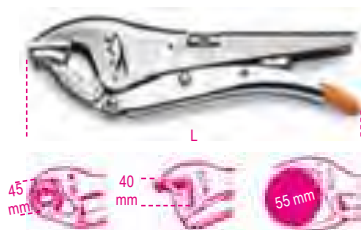

L mm	€	U	IT
220	93,00	2	010500022

1051

Gripzange, zweifach verstellbar, lange Backen

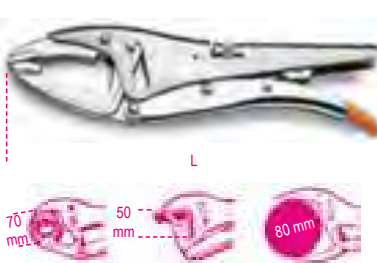

L mm	€	U	IT
255	102,00	2	010510025

1051GM

Gripzange, zweifach verstellbar, schwenkbare Backe

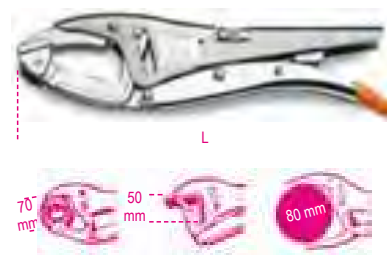

L mm	€	U	IT
255	110,00	2	010510250

1051L

Gripzange, zweifach verstellbar, großes Fassungsvermögen

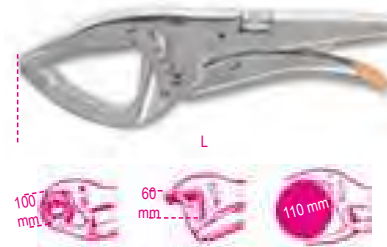

L mm	€	U	IT
270	117,00	2	010510100

1051XL

Gripzange, zweifach verstellbar, großes Fassungsvermögen, extralange Backen



L mm	€	U	IT
270	140,00	2	010510140

1052

Gripzangen, verstellbar, konkave Backen

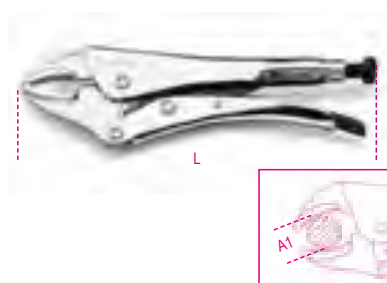

L mm	A1 max mm	€	U	IT
140	22	31,50	3	010520014
190	36	35,00	3	010520019
240	42	38,00	3	010520024
300	55	63,00	2	010520030

1053

Gripzange, verstellbar,
schwenkbare Backe

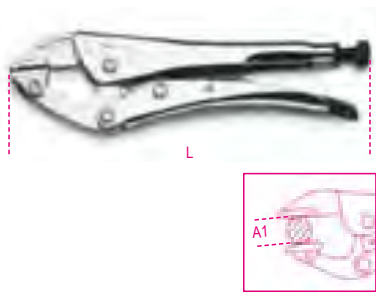

L mm	A1 max mm	€	🔧	📦
240	35	53,00	2	010530024

1054

Gripzange, verstellbar, gerade Backen

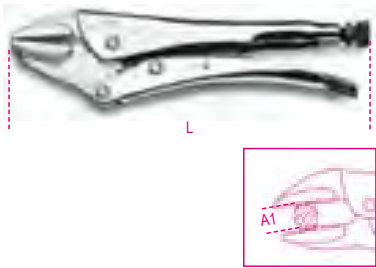

L mm	A1 max mm	€	🔧	📦
235	40	46,50	2	010540022

1055

Gripzange, verstellbar,
speziell geformte Backen

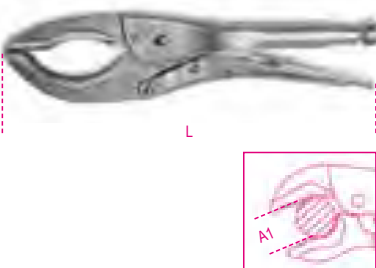

L mm	A1 max mm	€	🔧	📦
270	75	41,50	2	010550027

1055D

Gripzangen, verstellbar,
für Muttern und zylindrische Profile

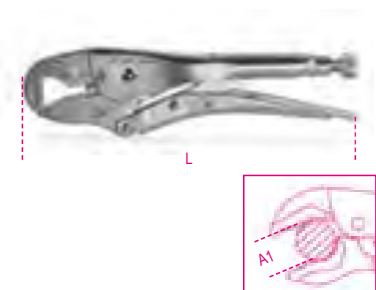

L mm	A1 max mm	€	🔧	📦
195	22	32,50	2	010550119
235	43	36,50	2	010550123

1056

Gripzange, verstellbar,
für Kühltechnik

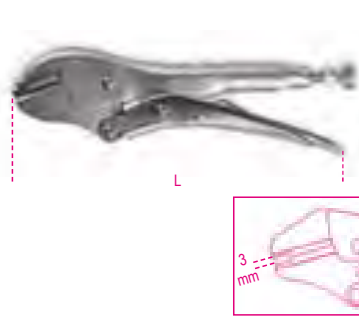

L mm	€	🔧	📦
195	32,50	2	010560017

1057A

Automatik-Gripzange mit
Spannkrafteinstellung



L mm	€	🔧	📦
240	65,50	2	010570124

1058

Gripzangen, verstellbar, lange Backen

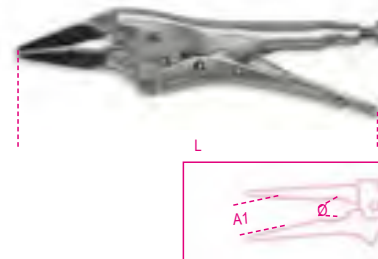

L mm	A1 max mm	Ø max mm	€	🔧	📦
175	34	26	39,50	2	010580017
225	46	31	47,50	2	010580025

1059

Gripzangen, verstellbar,
mit einer beweglichen Backe

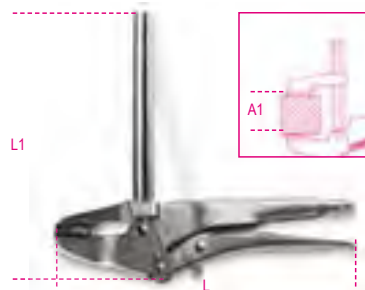

L1 mm	L mm	A1 mm	€	🔧	📦
160	255	120	71,00	1	010590016
270	255	220	74,00	1	010590027

1060

Gripzangen, verstellbar für Profileisen

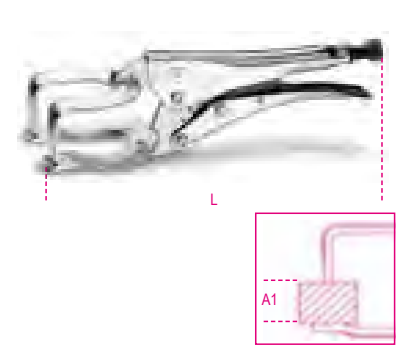

L mm	A1 max mm	€	🔧	📦
200	50	50,50	2	010600020
280	80	63,50	2	010600028

1061

Gripzange, verstellbar, für Rundmaterial

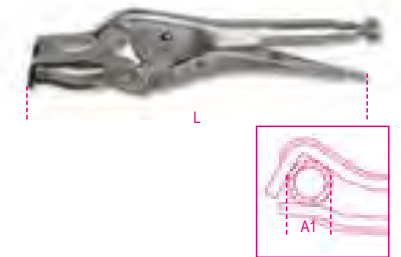

L mm	A1 max mm	€	🔧	📦
275	80	55,00	2	010610027

1062

Gripzangen, verstellbar,
mit weiter Ausladung

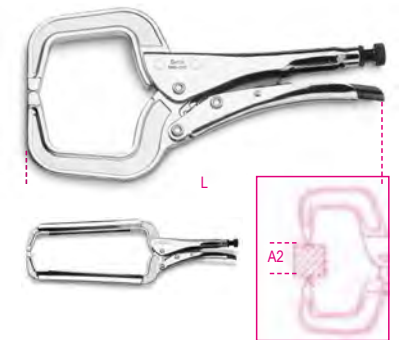

L mm	A2 max mm	€	🔧	📦
170	50	39,00	2	010620017
290	120	52,00	2	010620029
460	255	73,50	1	010620045



1062AL

Gripzangen, verstellbar,
mit weiter Ausladung,
Backen aus Aluminium

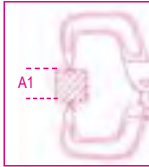

L mm	A1 max mm	€	🔧	📦
275	88	68,50	2	010620327

1062GM

Gripzangen, verstellbar,
mit weiter Ausladung,
Backen schwenkbar



L mm	A1 max mm	€	🔧	📦
170	45	43,00	2	010620217
290	88	60,00	2	010620229
460	255	85,00	1	010620245

1063

Gripzange, verstellbar, für Spengler

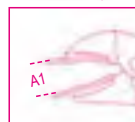

L mm	A1 max mm	€	🔧	📦
200	31	51,00	2	010630021

1064

Gripzange, verstellbar, mit Kette



L mm	Ø mm	€	🔧	📦
230	150	72,50	2	010640023

1065F

Lochzange

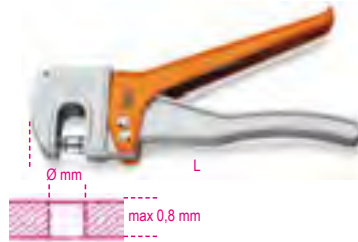

Ø mm	L mm	€	🔧	📦
5	228	140,00	1	010650010
6	228	141,00	1	010650015

1065P

Absetzlochzange

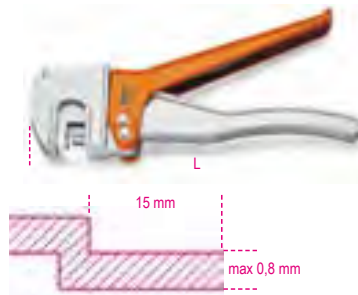

L mm	€	🔧	📦
228	144,00	1	010650020

1066

Verstellbare Gripzange, auf 90° feststellbar

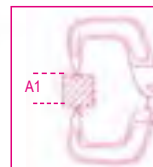

L mm	A1 max mm	g	€	🔧	📦
210	55	500	96,00	1	010660021

1067

Gripzangen, verstellbar, gelenkige
Klemmbacken

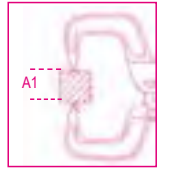

L mm	A1 max mm	€	🔧	📦
285	76	61,00	1	010670285
380	89	62,50	1	010670380

1077

Spenglerzange mit breiten Backen,
gerade, Griffe mit PVC-Überzug



L mm	A mm	L1 mm	€	🔧	📦
280	60	53	62,50	1	010770026

1078

Spenglerzange mit breiten Backen,
um 45° gebogen,
Griffe mit PVC-Überzug



L mm	A mm	L1 mm	€	🔧	📦
280	60	77	63,50	1	010780026

1080D

Diagonalseitenschneider
für bündigen Schnitt,
Griffe mit zweischichtigem Überzug
aus rutschfestem PVC
Zum Schneiden von Plastik



α	L mm	L1 mm	€	🔧	📦
15°	160	22	33,50	3	010800015
45°	160	22	40,00	3	010800045

1081

Seitenschneider für halbbündigen Schnitt, Griffe mit 2-schichtigem Überzug aus rutschfestem PVC

• Für Mikromechanik und Schwerelektronik

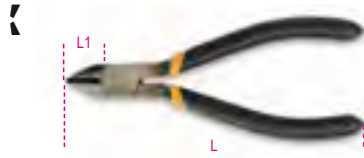

L	L1	€	Hand	ISO
mm	mm			
125	16	34,50	3	010810130

1082

Diagonalseitenschneider, verchromt, Griffe mit zweischichtigem Überzug aus rutschfestem PVC



UNI/ISO 5749

L	L1	€	Hand	ISO
mm	mm			
140	20	30,50	5	010820004
160	22	32,00	5	010820006

1082G

Diagonalseitenschneider, Griffe mit zweischichtigem Überzug aus rutschfestem PVC, Industrie-Finish

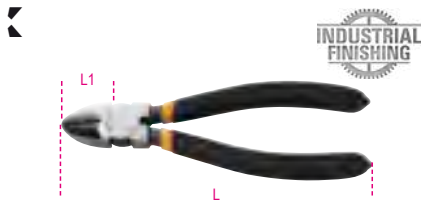

UNI/ISO 5749

L	L1	€	Hand	ISO
mm	mm			
140	20	26,00	5	010820064
160	22	27,50	5	010820066

1082BM

Diagonalseitenschneider, Griffe aus Bimaterial



UNI/ISO 5749

L	L1	€	Hand	ISO
mm	mm			
140	20	37,50	3	010820034
160	22	41,00	3	010820036

1082GBM

Diagonalseitenschneider, Griffe aus Bimaterial, Industrie-Finish



UNI/ISO 5749

L	L1	€	Hand	ISO
mm	mm			
140	20	33,00	3	010820264
160	22	37,00	3	010820266

1084

Diagonalseitenschneider für geringen Kraftaufwand, verchromt, Griffe mit zweischichtigem Überzug aus rutschfestem PVC



UNI/ISO 5749

L	L1	€	Hand	ISO
mm	mm			
160	22	35,00	5	010840006
200	28	44,00	3	010840010

1084G

Diagonalseitenschneider für geringen Kraftaufwand, Griffe mit zweischichtigem Überzug aus rutschfestem PVC, Industrie-Finish



UNI/ISO 5749

L	L1	€	Hand	ISO
mm	mm			
160	22	30,50	5	010840066
200	28	38,00	3	010840070

1084BM

Diagonalseitenschneider für geringen Kraftaufwand, verchromt, Griffe aus Bimaterial



UNI/ISO 5749

L	L1	€	Hand	ISO
mm	mm			
160	22	43,00	3	010840036
200	28	55,00	3	010840040

1084GBM

Diagonalseitenschneider für geringen Kraftaufwand, Griffe aus Bimaterial, Industrie-Finish



UNI/ISO 5749

L	L1	€	Hand	ISO
mm	mm			
160	22	47,00	3	010840266
200	28	60,00	3	010840270

1088

Vornschnneider für geringen Kraftaufwand Griffe mit zweischichtigem Überzug aus rutschfestem PVC

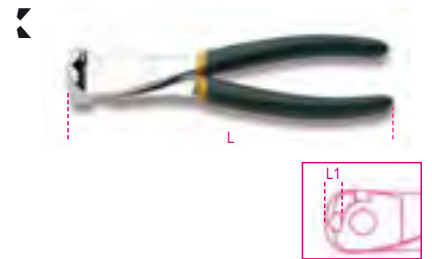

UNI/ISO 5748

L	L1	€	Hand	ISO
mm	mm			
160	9	43,50	2	010880036
200	11	56,50	2	010880010

1088BM

Vornschnneider für geringen Kraftaufwand, Griffe aus Bimaterial

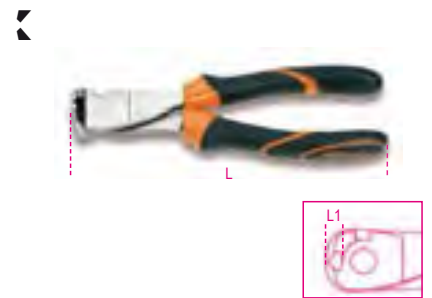

UNI/ISO 5748

L	L1	€	Hand	ISO
mm	mm			
160	9	52,50	2	010880036
200	11	72,00	2	010880040



1092V
Hebelvornschneider, schwere Ausführung



UNI/ISO 5748

L mm	L1 mm	Ø mm	€	U	W
180	8	2,0	172,00	2	010920280
200	9	2,5	182,00	2	010920310

1094V
Hebelseitenschneider, schwere Ausführung



UNI/ISO 5749

L mm	L1 mm	Ø mm	€	U	W
200	23	2,5	172,00	2	010940200

1095N
Hebelseitenschneider



L mm	L1 mm	Ø mm	€	U	W
195	26	1,6	61,00	2	010950010

1096
Beisszangen für Tischler



ISO 9243

L mm	L1 mm	€	U	W
160	21	23,20	5	010960016
200	23	27,00	5	010960020
250	30	36,50	5	010960025

1098
Flechtermaggen



ISO 9242 DIN 5242

L mm	L1 mm	€	U	W
190	12	23,20	5	010980190
220	13	26,50	5	010980220
250	15	31,50	5	010980250
280	18	34,50	5	010980280

1098PL
Flechtermaggen, Griffe mit PVC-Überzug

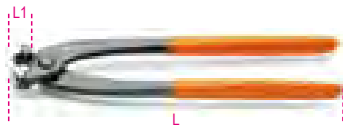

ISO 9242 DIN 5242

L mm	L1 mm	€	U	W
220	13	28,50	5	010980320
250	15	33,50	5	010980350
280	18	37,00	5	010980380

1101
Bolzenschneider, Handgriffe aus Gummi



L mm	L mm	€	U	W
300	12	68,50	2	011010030
350	14	83,50	2	011010035
450	18	103,00	1	011010045
600	24	141,00	1	011010060
750	30	182,00	1	011010075
900	36	243,00	1	011010090

L mm	R = 80 Kg/mm² Ø mm	R = 140 Kg/mm² Ø mm	g	W
300	5	4	745	
350	6	5	1043	
450	7	6	1537	
600	9	7	2540	
750	11	8	3870	
900	12	9	6170	



1101R
Ersatzschneidmesser für Art. 1101



mm	1101	€	U	W
300	300	41,00	1	011010130
350	350	47,50	1	011010135
450	450	61,00	1	011010145
600	600	82,00	1	011010160
750	750	102,00	1	011010175
900	900	135,00	1	011010190

1102
Minibolzenschneider

R= 80 Kg/mm²



L mm	Ø mm	€	U	W
230	4	51,00	3	011020020

1103
Flachkopf-Bolzenschneider für Eisen, Bolzen und elektrogeschweißte Netze für Betonverstärkung

Max. Ø = 12 mm
Max. Ø (HRC 48) = 6 mm

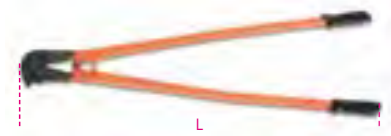

L mm	€	U	W
950	183,00	1	011030090

1103R
Ersatzkopf für Art. 1103



1103R 950	€	U	W
	109,00	1	011030190

1104
Kabelschneider für flexible Stahlseile
Handgriffe aus thermoplastischem Material



L mm	mm	€		
420	12	177,00	1	011040004
600	16	258,00	1	011040006

1104R
Ersatzschneidmesser für Art. 1104



mm	€		
420	110,00	1	011040014
600	153,00	1	011040016

1105
Locheisen aus brüniertem Stahl

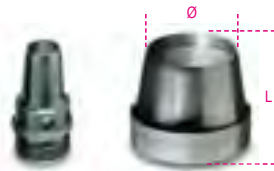

D mm	L mm	€		
2	27	17,70	1	011050002
3	27	17,70	1	011050003
4	27	17,70	1	011050004
5	27	17,70	1	011050005
6	27	17,70	1	011050006
7	27	17,70	1	011050007
8	27	17,70	1	011050008
9	27	17,70	1	011050009
10	27	17,70	1	011050010
12	27	21,70	1	011050012
14	27	21,70	1	011050014
16	27	21,70	1	011050016
18	27	21,70	1	011050018
20	27	21,70	1	011050020
22	32	27,00	1	011050022
24	32	27,00	1	011050024
26	32	27,00	1	011050026
28	32	27,00	1	011050028
30	32	27,00	1	011050030
32	37	35,00	1	011050032
34	37	35,00	1	011050034
36	37	35,00	1	011050036
38	37	35,00	1	011050038
40	37	35,00	1	011050040
42	42	41,50	1	011050042
44	42	41,50	1	011050044
46	42	41,50	1	011050046
48	42	41,50	1	011050048
50	42	41,50	1	011050050

1105T20
Griffstück für Locheisen Art. 1105
mit Ø 2 bis 20 mm



L mm	€		
110	87,50	1	011050200

1105T30
Griffstück für Locheisen Art. 1105
mit Ø 3 bis 30 mm



L mm	€		
175	189,00	1	011050205

1105T50
Griffstück für Locheisen Art. 1105
mit Ø 2 bis 50 mm



L mm	€		
175	187,00	1	011050207

1105AD-50
Adapter für Griffstück Art. 1105T50



Ø mm	€		
57	119,00	1	011050210

1105/C10T
Sortiment mit 10 Locheisen,
mit Ø 3 bis 20 mm und 1 Betätigungswerkzeug



1105C/10T	€		
	196,00	1	011050250

	1105		
		3 - 4 - 6 - 8 - 10 - 12 - 14 - 16 - 18 - 20 mm	
	1105T20		

135x92x32 mm

1105/C16T
Sortiment mit 15 Locheisen,
Ø 3 bis 30 mm, und 1 Betätigungswerkzeug



1105C/16T	€		
	354,00	1	011050255

	1105		
		3 - 4 - 6 - 8 - 10 - 12 - 14 - 16 - 18 - 20 - 22 - 24 - 26 - 28 - 30 mm	
	1105T30		

240x210x60 mm

1105/C32T
Sortiment mit 29 Locheisen,
Ø 2 bis 50 mm, und 3 Betätigungswerkzeugen



1105C/32T	€		
	692,00	1	011050257

	1105		
		2 - 3 - 4 - 5 - 6 - 7 - 8 - 9 - 10 - 12 - 14 - 16 - 18 - 20 - 22 - 24 - 26 - 28 - 30 - 32 - 34 - 36 - 38 - 40 - 42 - 44 - 46 - 48 - 50 mm	
	1105T50		
	1105AD-50		

455x380x115 mm

1112
Figurschere,
amerikanisches Modell mit breiten,
geraden Schneiden
R= 60 Kg/mm²



L	L1	S	A	€		
mm	mm	mm	mm			
200	50	0,5	26	30,50	2	011120020
250	62	0,8	33	37,00	2	011120025
300	76	1,0	37	47,50	2	011120030
375	76	1,2	44	69,50	1	011120037

1114

Figureschere, amerikanisches Modell, mit schmalen, geraden Schneiden
R = 60 Kg/mm²

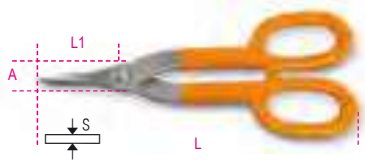

L	L1	S	A	€	U	W
mm	mm	mm	mm			
250	58	0,5	15	33,00	1	011140265
350	76	1	22	43,50	1	011140340

1118

Unfallsichere Blechscherer für Bandeisen

Fe = Normalstahl
Inox = Edelstahl



L	L1	Fe	Inox	€	U	W
mm	mm	S mm	S mm			
310	42	1	0,8	53,50	2	011180001

1120A

Blechknabber

Fe = Normalstahl



L	Fe	€	U	W
mm	S mm			
280	1,2	86,00	1	011200101

1120ARL - ARG

Ersatzteile für Art. 1120A



	€	U	W
1120ARL	21,50	1	011200110
1120ARG	27,00	1	011200120

1122

Hebelfigureschere, geradeschneidend
Inox = Edelstahl



L	L1	Inox	A	€	U	W
mm	mm	S mm	mm			
250	40	1	24	41,50	2	011220020

1123

Hebelblechscherer, rechtsschneidend, gebogene Schneiden
Inox = Edelstahl

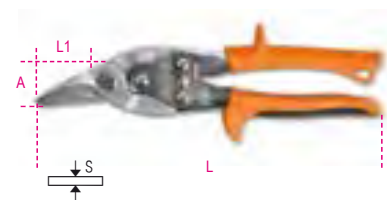

L	L1	Inox	A	€	U	W
mm	mm	S mm	mm			
250	40	1	24	41,50	2	011230020

1124

Hebelblechscherer, linksschneidend, gebogene Schneiden
Inox = Edelstahl



L	L1	Inox	A	€	U	W
mm	mm	S mm	mm			
250	40	1	24	41,50	2	011240020

1125

Hebelblechscherer, gerade- und rechtsschneidend
Inox = Edelstahl



L	L1	Inox	A	€	U	W
mm	mm	S mm	mm			
250	35	1	46	64,50	2	011250020

1126

Hebelblechscherer, gerade- und linksschneidend
Inox = Edelstahl



L	L1	Inox	A	€	U	W
mm	mm	S mm	mm			
250	35	1	46	64,50	2	011260020

1122 - 1125MOL



	€	U	W
1122 MOL 1122 - 1124	1,90	1	011220010
1123 MOL 1123	1,70	1	011230010
1125 MOL 1125 - 1126	1,70	1	011250040

1127

Drahtschere, gerade Schneiden



L	L1	€	U	W
mm	mm			
150	35	18,10	5	011270001

1128BAX

Doppeltwirkende Elektrikerschere, mit Fräsenprofil aus rostfreiem Stahl mit DLC-Beschichtung

Doppeltwirkender Schnitt: Durch eine besondere Nocke auf dem Scharnier ist ein Längslauf der Messer möglich, der beim Schließen, die Schneidkraft der Schere erhöht.

Fräsprofil: Zum Weiten der Löcher auf Kunststoff von 13 bis 25 mm.

DLC Beschichtung: DLC (diamond-like carbon) ist eine innovative kohlenstoffbasierte Beschichtung: Die hohe Härte und der niedrige Reibkoeffizient entstehen durch das gleichzeitige Vorhandensein von Carbon, das in Form von Graphit gelagert ist, und einem diamantähnlichen Kohlenstoff.

- Hohe Oberflächenhärte der Messer (Abriebfestigkeit und Beibehaltung des Schliffs auf Dauer)
- Niedriger Reibkoeffizient (gleitender und kräftiger Schnitt)
- Antilockerungs-Exzenterstift
- Weite Griffe mit Rohrverengungskehlen
- Geliefert mit Kunststoffbeutel



L	L1	€	U	W
mm	mm			
150	50	39,50	5	011280088

1128BMX

Elektrikerschere, gerade Schneiden aus rostfreiem Stahl, mit Mikroverzahnung



L	L1	€	U	W
mm	mm			
147	58,2	21,20	5	011280051

1128BMX/F

Gelenkettui aus Kunststoff für Art. 1128BMX



	€	U	W
1128BMX/F	2,30	1	011280059

1128FXS ELEKTRIKERSCHERE MIT STUFENWEISEM FRÄSENPROFIL

Wir haben der Elektrikerschere ein neues Design gegeben, nachdem wir die tägliche Arbeit der Anwender beobachtet haben. Aufgrund der in sich einschließenden 4 Funktionen haben wir sie zu einem universalen Werkzeug gemacht.

- SNITT** Schnell und sauber, für Kabel bis zu 50 mm², dank der Kabelschneidrinne und einer mikroverzahnten Klinge für einen besseren Griff.
- ABSETZEN** Die Sensibilität des Antilockerungs-Exzenterstiftes ermöglicht das präzise Absetzen auch von den dünnsten Kabeln.
- CRIMPEN** Sicher und fest auch auf lange Zeit, für Röhren Kabelschuhe.
- ANSENKEN** Das exklusive Fräsprofil ermöglicht das Ansenken der Bohrungen der Abzweignästen auf präzise und saubere Weise.



1128BAX DOPPELTWIRKENDE ELEKTRIKERSCHERE MIT FRÄSENPROFIL AUS ROSTFREIEM STAHL MIT DLC-BESCHICHTUNG

Die Messer der Elektrikerschere 1128BAX sind mit DLC beschichtet. DLC (diamond-like carbon) ist eine innovative kohlenstoffbasierte Beschichtung: Die hohe Härte und der niedrige Reibkoeffizient entstehen durch das gleichzeitige Vorhandensein von Carbon, das in Form von Graphit gelagert ist, und einem diamantähnlichen Kohlenstoff.

- Hohe Oberflächenhärte der Messer – Abriebfestigkeit und Beibehaltung des Schiffs auf Dauer
- Niedriger Reibkoeffizient – Gleitender und kräftiger Schnitt



+HÖHERE HÄRTE
-NIEDRIGERER REIBKOEFFIZIENT



1128BSX

Elektrikerschere mit stufenweisem Fräsprofil, mit Etui

L mm	L1 mm	€	5	011280061
148	58,2	36,50		

1128FX

Elektrikerschere gerade Schneiden aus rostfreiem Stahl mit Mikroverzahnung, Kabelschneidrinne und Crimper für Kabelschuhe Röhren.

- Gelenketui, kann am Gürtel eingehakt werden
- Bimaterial-Griff
- Antilockerungs-Exzenterstift

L mm	L1 mm	mm ²	€	5	011280090
145	52	50	38,50		

1128FXS

Elektrikerschere mit stufenweisem Fräsprofil, gerade Schneiden aus rostfreiem Stahl mit Mikroverzahnung, Kabelschneidrinne und Crimper für Kabelschuhe Röhren

- Gelenketui, kann am Gürtel eingehakt werden
- Bimaterial-Griff
- Antilockerungs-Exzenterstift
- Fräsprofil: Zum Weiten der Löcher auf Kunststoff von 13 bis 21 mm

L mm	L1 mm	mm ²	€	5	011280095
145	52	50	46,00		

1128BM

Elektrikerschere, gerade Schneiden

L mm	L1 mm	€	5	011280000
145	50	18,40		

1129BM

Elektrikerschere, gebogene Schneiden

L mm	L1 mm	€	5	011290000
145	44	19,60		

1130BMX

Mehrzweckschere, gerade Schneiden aus rostfreiem Stahl, mit Mikroverzahnung

L mm	L1 mm	€	1	011300002
185	60	23,70		

1131CK

Kevlar®- und Optikfaserschere

L mm	L1 mm	€	1	011310001
203	75	95,00		

1132

Kabelschneider

Griffe mit zweischichtigem Überzug aus rutschfestem PVC
Für isolierte Kupfer- und Aluminiumkabel



UNI 8791

L	mm	mm ²	€	U	PC
170	14	50	58,50	2	011320107
230	18	95	72,00	2	011320113

1132BM

Kabelschneider, Griffe aus Bimaterial, für isolierte Kupfer- und Aluminiumkabel



UNI 8791

L	mm	mm ²	€	U	PC
170	14	50	72,00	2	011320137
230	18	95	88,00	2	011320143

1133

Kabelschneider für Kupferkabel, flexibel

bis 325 mm²



L	mm	mm ²	€	U	PC
600	30	325	201,00	1	011330001

1133RL

Ersatzschneiden für Art. 1133



1133RL	€	U	PC
	151,00	1	011330011

1134

Kabelschneider mit Knarre



L	mm	mm ²	mm ²	€	U	PC
260	35	400		584,00	1	011340032

1134RL

Ersatzschneide für Art. 1134



1134RL	€	U	PC
	265,00	1	011340132

1134A

Kabelschneider mit Knarre



L	mm	mm ²	mm ²	€	U	PC
240	45	500		888,00	1	011340045



1142BM

Abisolierzange, Griffe aus Bimaterial



UNI 7923

L	mm	mm ²	mm	€	U	PC
160		0,5÷6	0-2,8	47,50	3	011420036

1143

Schneid- und Abisolierzange



L	mm	mm ²	mm	€	U	PC
165		0,5÷6	1-3,2	93,00	1	011430001

1143R

Ersatzschneiden für Art. 1143

1143R	€	U	PC
	23,60	1	011430011

1144D

Abisoliergerät



L	mm	mm ²	mm	€	U	PC
170		4,5÷240	2,5-18	113,00	1	011440010

1144D/RG

Ersatzhaken für Art. 1144D



1144D/RG	€	U	PC
	37,50	1	011440012

1144D/RL

Ersatzschneidmesser für Art. 1144D

1144D/RL	€	U	PC
	57,50	1	011440011

1144G

Abisoliergerät

Mit verstellbarem Schneidmesser für Quer- und Längsschnitte



L	mm	mm ²	mm	€	U	PC
140		6÷75	2,8-12	62,50	1	011440004

1144G/RL

Ersatzschneidmesser für Art. 1144G



1144G/RL	€ 13,90	1	011440005
----------	---------	---	-----------

1144L

Abisoliergerät mit verstellbarem Messer für Quer- und Längsschnitte

Mit glattem einziehbarem Messer und Haken



L mm	↔ mm ²	↔ mm	€	1	011440050
145	6-150	4-28	36,50		

1144T

Abisoliergerät, verstellbar, im Taschenformat, mit Abschneidevorrichtung



L mm	↔ mm	g	€	1	011440060
112	3,5 ÷ 9	40	25,00		

1148A

Selbstverstellbare Schneid- und Abisolierzange

10 mm² (8 AWG) biegsame Leitungen
1,5 mm² (16 AWG) unbiegsame Leitungen



L mm	↔ mm ²	↔ mm	€	1	011480100
190	0,02 ÷ 10	0-4	192,00		

1148A/R

Ersatzschneidmesser für Art. 1148A



1148A/R	€ 82,00	1	011480102
---------	---------	---	-----------

Beta

1148B

Selbstverstellbare Schneid- und Abisolierzange



L mm	↔ mm ²	↔ mm	€	1	011480200
190	4 ÷ 16	2-5	225,00		

1148B/R

Ersatzschneidmesser für Art. 1148B



1148B/R	€ 103,00	1	011480202
---------	----------	---	-----------

1148P

Selbstverstellbare Schneid- und Abisolierzange



L mm	↔ mm ²	↔ mm	€	1	011480300
165	0,2-6	0-3,5	53,50		

1149F

Selbstverstellbare Schneid- und Abisolierzange



L mm	↔ mm ²	€	1	011490010
175	0,2 ÷ 6	20,80		

1150

Universalzange verchromt, poliert
Griffe mit zweischichtigem Überzug aus rutschfestem PVC

• Der dezentrierte Stift erhöht die Hebelwirkung und reduziert so den Kraftaufwand für einen leistungsstarken Schnitt.



ISO 5746

L mm	L1 mm	mm	€	1	011500046
160	42	1,6	26,50	5	011500046
180	46	1,8	29,00	5	011500048
200	50	2,0	32,00	5	011500050
220	50	2,0	34,50	2	011500052

1150G

Universalzangen für geringen Kraftaufwand, Griffe mit zweischichtigem Überzug aus rutschfestem PVC, Industrie-Finish

• Optimales Qualität/Preis-Verhältnis
• Der dezentrierte Stift erhöht die Hebelwirkung und reduziert so den Kraftaufwand für einen leistungsstarken Schnitt.



ISO 5746

L mm	L1 mm	mm	€	1	011500066
160	42	1,6	24,80	5	011500066
180	46	1,8	27,00	5	011500068
200	50	2,0	30,50	5	011500070
220	50	2,0	32,00	2	011500072

Beta

1150HPC UNIVERSAL-KRAFTZANGE HYPERCUT MIT SCHNEIDEN AUS SINTERSTAHL

- Der dezentrierte Zapfen nähert den Drehpunkt der Schnittstelle und erhöht so die Hebelwirkung.
- Die perfekte Ausrichtung der Backen und das ausgespitzte Profil garantieren ein sicheres Greifen, auch auf sehr engem Raum.
- Der Zangenkörper nutzt den zuverlässigen thermisch bearbeiteten Molybdän-Stahl, der flexibel und beständig ist, und einen sicheren Griff unter jeder Bedingung garantiert.

Schubspannung statische Prüfung =	-73%
Mittlere Lebensdauer der Schneiden (Test ISO 5744) =	+127%
Härte der Stahlschneiden M2 =	65HRC

ABSOLUTE INNOVATION

PERL-CHROMBE-SCHICHTUNG

HOHE SCHNEIDKRAFT

1150HPC

Universal-Kraftzangen mit eingesetzter Schneide
dezentrierter Zapfen
chromsatinierter
Bimaterial-Griff
offenes Gelenk
eingesetzte Schneide
Stahl: M2
Stärke: 0,20 mm
Winkel: 62°
Härte: 63+65 HRC



ISO 5746

L mm	L1 mm	mm	€	U	U
180	42	1,8	72,50	2	011500618



1150BM

Universalzangen, verchromt, poliert, Griffe aus Bimaterial

- Der dezentrierte Stift erhöht die Hebelwirkung und reduziert so den Kraftaufwand für einen leistungsstarken Schnitt.



ISO 5746

L mm	L1 mm	mm	€	U	U
160	42	1,6	33,00	3	011500146
180	46	1,8	36,50	3	011500148
200	50	2,0	39,50	3	011500150
220	50	2,0	43,00	2	011500152

1150GBM

Universalzangen für geringen Kraftaufwand, Griffe aus Bimaterial, Industrie-Finish

- Der dezentrierte Stift erhöht die Hebelwirkung und reduziert so den Kraftaufwand für einen leistungsstarken Schnitt.
- Optimales Qualität/Preis-Verhältnis



ISO 5746

L mm	L1 mm	mm	€	U	U
160	42	1,6	30,50	3	011500266
180	39	1,8	33,00	3	011500268
200	50	2,0	37,50	3	011500270
220	50	2,0	39,50	2	011500272

1153

Zangen, 2fach verstellbar, Griffe mit PVC-Überzug



UNI ISO 9343

L mm	L1 mm	€	U	U
200	34	30,50	2	011530120

1162

Flachzangen mit geraden Backen, extralang, innengeriffelt, verchromt, Griffe mit zweischichtigem Überzug aus rutschfestem PVC

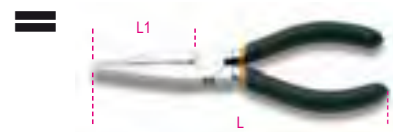

ISO 5745

L mm	L1 mm	mm	€	U	U
160	58	1,6	31,50	5	011620006
200	86	1,6	36,50	5	011620010



1162G

Flachzangen mit geraden Backen, extralang, innengeriffelt, Griffe mit zweischichtigem Überzug aus rutschfestem PVC, Industrie-Finish

• Optimales Qualität/Preis-Verhältnis



ISO 5745

L mm	L1 mm	mm	€	Hand	ISO
160	58	1,6	26,50	5	011620066
200	86	1,6	30,50	5	011620070

1162BM

Flachzangen mit geraden Backen, extralang, innengeriffelt, verchromt, Griffe aus Bimaterial



ISO 5745

L mm	L1 mm	mm	€	Hand	ISO
160	58	1,6	38,00	3	011620036
200	86	1,6	43,00	3	011620040

1162GBM

Flachzangen mit geraden Backen, extralang, innengeriffelt, Griffe aus Bimaterial, Industrie-Finish

• Optimales Qualität/Preis-Verhältnis



ISO 5745

L mm	L1 mm	mm	€	Hand	ISO
160	58	1,6	33,00	3	011620266
200	86	1,6	38,50	3	011620270

1164

Flachzangen mit gebogenen Backen, extralang, innengeriffelt, Griffe mit zweischichtigem Überzug aus rutschfestem PVC



ISO 5745

L mm	L1 mm	mm	€	Hand	ISO
160	54	1,6	34,00	5	011640006
200	76	1,6	38,00	5	011640010

1164BM

Flachzangen mit gebogenen Backen, extralang, innengeriffelt, Griffe aus Bimaterial



ISO 5745

L mm	L1 mm	mm	€	Hand	ISO
160	54	1,6	41,50	3	011640036
200	76	1,6	47,00	3	011640040

1166

Zangen mit halbrunden Backen, extralang, gerade, innengeriffelt, verchromt, Griffe mit zweischichtigem Überzug aus rutschfestem PVC



ISO 5745

L mm	L1 mm	mm	€	Hand	ISO
160	56	1,6	31,50	5	011660006
200	76	1,6	36,50	5	011660010

1166G

Zangen mit halbrunden Backen, extralang, gerade, innengeriffelt, Griffe mit zweischichtigem Überzug aus rutschfestem PVC, Industrie-Finish

• Optimales Qualität/Preis-Verhältnis

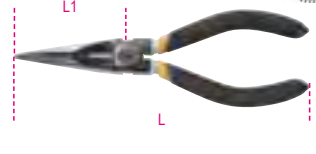

ISO 5745

L mm	L1 mm	mm	€	Hand	ISO
160	56	1,6	26,50	5	011660066
200	76	1,6	30,50	5	011660070

1166BM

Zangen mit halbrunden Backen, extralang, gerade, innengeriffelt, verchromt, Griffe aus Bimaterial



ISO 5745

L mm	L1 mm	mm	€	Hand	ISO
160	56	1,6	38,00	3	011660036
200	76	1,6	43,00	3	011660040

1166GBM

Zangen mit halbrunden Backen, extralang, gerade, innengeriffelt, Griffe aus Bimaterial, Industrie-Finish

• Optimales Qualität/Preis-Verhältnis

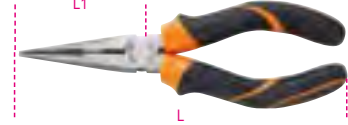

ISO 5745

L mm	L1 mm	mm	€	Hand	ISO
160	56	1,6	33,00	3	011660266
200	76	1,6	38,50	3	011660270

1168

Zangen mit halbrunden Backen, extralang, gebogen, innengeriffelt, verchromt, Griffe mit zweischichtigem Überzug aus rutschfestem PVC



ISO 5745

L mm	L1 mm	mm	€	Hand	ISO
160	54	1,6	34,00	5	011680006
200	76	1,6	38,00	5	011680010

1168G

Zangen mit halbrunden Backen, extralang, gebogen, innengeriffelt, Griffe mit zweischichtigem Überzug aus rutschfestem PVC, Industrie-Finish

• Optimales Qualität/Preis-Verhältnis



ISO 5745

L mm	L1 mm	mm	€	Hand	ISO
160	54	1,6	29,00	5	011680066
200	76	1,6	33,00	5	011680070

1168BM

Zangen mit halbrunden Backen, extralang, gebogen, innengeriffelt, verchromt, Griffe aus Bimaterial



ISO 5745

L mm	L1 mm	mm	€	U	IT
160	54	1,6	41,50	3	011680036
200	70	1,6	47,00	3	011680040

1168GBM

Zangen mit halbrunden Backen, extralang, gebogen, innengeriffelt, Griffe aus Bimaterial, Industrie-Finish

• Optimales Qualität/Preis-Verhältnis



ISO 5745

L mm	L1 mm	mm	€	U	IT
160	54	1,6	37,00	3	011680266
200	70	1,6	41,50	3	011680270

1169/D3

Sortiment aus 1 Universalzange, 1 Zange mit langen halbrunden Backen und 1 Schneidzange



1169/D3	€	U	IT
1082 160mm	91,50	1	011690053
1150 180mm			
1166 160mm			

1169G/D3

Sortiment aus 1 Universalzange, 1 Zange mit langen halbrunden Backen und 1 Schneidzange, mit zweischichtigem Überzug aus rutschfestem PVC, mit Industrie-Finish

• Optimales Qualität/Preis-Verhältnis



1169G/D3	€	U	IT
1082G 160mm	81,00	1	011690073
1150G 180mm			
1166G 160mm			

1169BM/D3

Sortiment aus 1 Universalzange, 1 Zange mit langen halbrunden Backen und 1 Schneidzange, Griffe aus Bimaterial



1169BM/D3	€	U	IT
1082BM 160mm	115,50	1	011690133
1150BM 180mm			
1166BM 160mm			

1169GBM/D3

Sortiment aus 1 Universalzange, 1 Zange mit langen halbrunden Backen und 1 Schneidzange, Griffe aus Bimaterial, mit Industrie-Finish

• Optimales Qualität/Preis-Verhältnis



1169GBM/D3	€	U	IT
1082GBM 160mm	103,00	1	011690273
1150GBM 180mm			
1166GBM 160mm			

1169N/D4

Sortiment aus 1 Universalzange für geringen Kraftaufwand, 1 Zange mit langen halbrunden Backen, 1 Schneidzange, verchromt, und 1 Zange mit durchgestecktem Gelenkt, phosphatiert



1169N/D4	€	U	IT
1082 160 mm	125,00	1	011690024
1150 180 mm			
1166 160 mm			
1048N 250 mm			

1171BM

Flachzange mit kurzen, glatten Backen, Griffe aus Bimaterial



ISO 9655

L	L1 mm	A mm	B mm	€	U	IT
130	18	12	8	52,00	2	011720101

1172BM

Flachzange mit langen, glatten Backen, Griffe aus Bimaterial

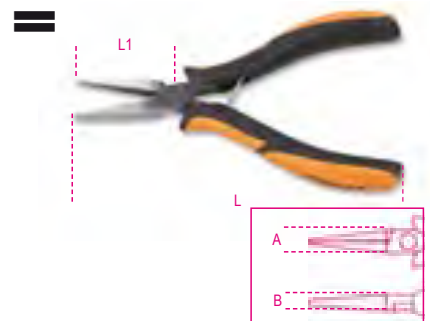

ISO 9655

L	L1 mm	A mm	B mm	€	U	IT
140	40	12	8	52,00	2	011720101



1172BM/P

Flachzange mit langen, glatten Backen, gebogen, Griffe aus Bimaterial

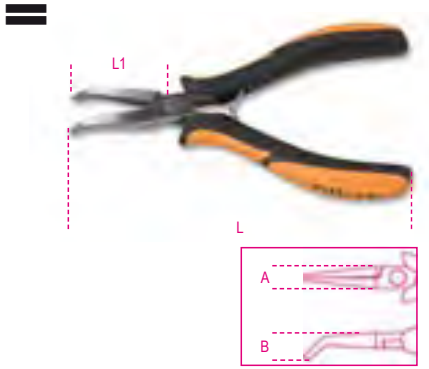

L	L1	A	B	€	2	011720102
140	38 mm	12 mm	13 mm	59,50		

1173BM

Zange mit runden Backen, kurz, Griffe aus Bimaterial



L	L1	A	B	€	2	011730101
125	22 mm	12 mm	8 mm	52,00		

1175BM

Zange mit halbrunden Backen, kurz, glatt, Griffe aus Bimaterial



L	L1	A	B	€	2	011750101
140	29 mm	12 mm	8 mm	52,00		

1177BM

Zange mit halbrunden Backen, lang, glatt Griffe aus Bimaterial

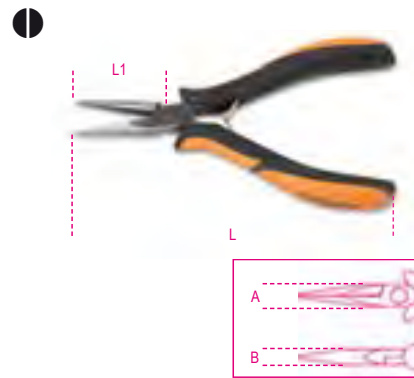

L	L1	A	B	€	2	011770101
140	38 mm	12 mm	8 mm	52,00		

1177BM/Z

Zange mit halbrunden Backen, lang, innengeriffelt, Griffe aus Bimaterial

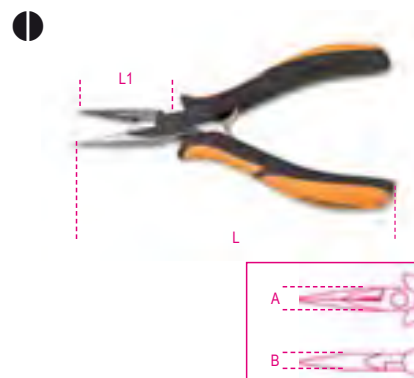

L	L1	A	B	€	2	011770113
140	39 mm	12 mm	8 mm	59,50		

1178BM

Zange mit halbrunden Backen, lang, glatt, verjüngt, Griffe aus Bimaterial

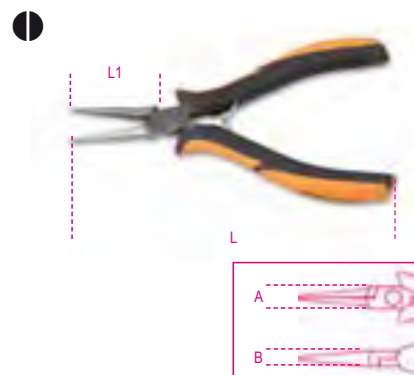

L	L1	A	B	€	2	011780101
140	37 mm	12 mm	8 mm	59,50		

1178BM/P

Zange mit halbrunden Backen, lang, glatt, gebogen, verjüngt, Griffe aus Bimaterial

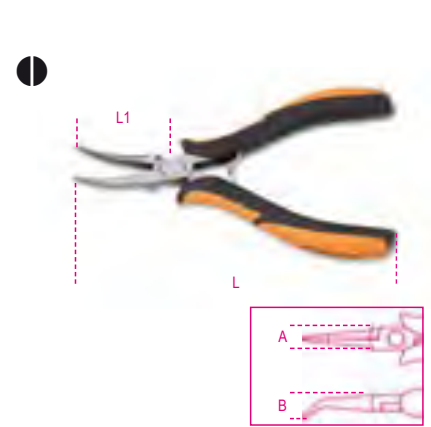

L	L1	A	B	€	2	011780102
140	36,5 mm	12 mm	12 mm	59,50		

Es folgen Kupferschneider.
Für schwerere Einsätze siehe Art. 1081

1182BM

Diagonalseitenschneider für halbbündigen Schnitt, schlanke Backen Griffe aus Bimaterial



L	L1	A	Cu	€	2	011820101
120	11 mm	10 mm	1 mm	59,50		



1183BM

Diagonalseitenschneider
für halbündigen Schnitt,
abgerundete Backen
Griffe aus Bimaterial



ISO 9654

L	L1	A	Cu	€	U	W
mm	mm	mm	mm			
120	11	10	1	59,50	2	011830101

1186BM

Diagonalseitenschneider
für bündigen Schnitt,
schlanke, abgeflachte Backen
Griffe aus Bimaterial



ISO 9654

L	L1	A	Cu	€	U	W
mm	mm	mm	mm			
120	11	10	1	59,50	2	011860101
130	13	12,5	1,25	59,50	2	011860102

1191BM

Vornschneider, abgeschrägt,
für bündigen Schnitt
Griffe aus Bimaterial



ISO 9654

L	L1	A	Cu	€	U	W
mm	mm	mm	mm			
130	8	12	0,8	59,50	2	011910101

1184BM

Diagonalseitenschneider
für bündigen Schnitt,
abgerundete Backen
Griffe aus Bimaterial



ISO 9654

L	L1	A	Cu	€	U	W
mm	mm	mm	mm			
120	11	10	1	59,50	2	011840101
130	13	12,5	1,25	59,50	2	011840102

1188BM

Diagonalseitenschneider
für mittigen Schnitt
Griffe aus Bimaterial

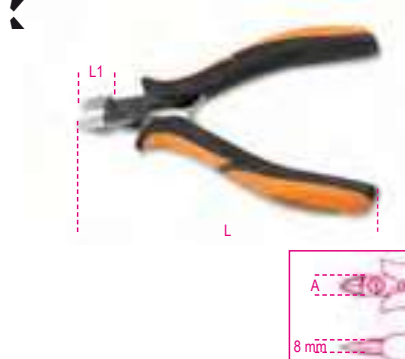

ISO 9654

L	L1	A	Cu	€	U	W
mm	mm	mm	mm			
125	12	12	1,25	59,50	2	011880101
130	17	15	2	59,50	2	011880102

1191BM/L

Vornschneider, abgeschrägt,
für bündigen Schnitt,
lange, schlanke Backen
Griffe aus Bimaterial

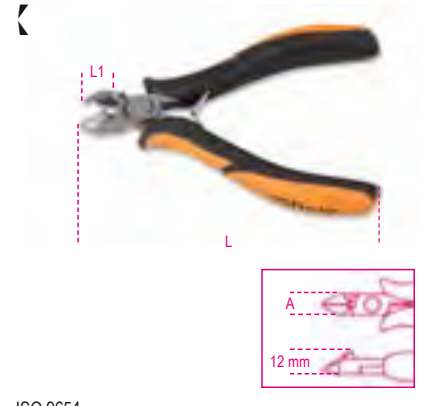

ISO 9654

L	L1	A	Cu	€	U	W
mm	mm	mm	mm			
130	18	12	1	59,50	2	011910110

1185BM

Diagonalseitenschneider
für bündigen Schnitt,
schlanke Backen
Griffe aus Bimaterial



ISO 9654

L	L1	A	Cu	€	U	W
mm	mm	mm	mm			
120	11	10	1	59,50	2	011850101
130	13	12,5	1,25	59,50	2	011850102

1190BM

Vornschneider
für halbündigen Schnitt
Griffe aus Bimaterial



ISO 9654

L	L1	A	Cu	€	U	W
mm	mm	mm	mm			
120	12	12	1,25	59,50	2	011900113

1191R/5-M

Satz Ersatzfedern für Elektronik-Zangen und
Elektronik-Schneider, 5 Paar (Art.:
1171...1191)

1191R/5-M	€	U	W
	11,80	1	011910995

1200MS

Magnetisierer/Demagnetisierer

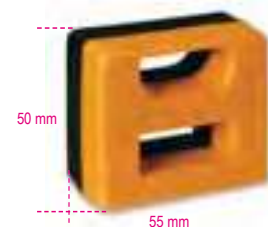

1200MS	€	U	W
	18,70	5	012000000

DIE WEITERENTWICKLUNG DES SCHRAUBENDREHERS!

Das ergonomische Design passt sich perfekt der Handfläche an. Dank der breiten Kontaktfläche kann mit niedrigstem Kraftaufwand die maximale Kraft übertragen werden.

Die geprüften Beta Klingen bieten Elastizität, Härte und Verschleißfestigkeit an der Spitze der Kategorie der professionellen Schraubendreher.

Der achteckige Querschnitt vermeidet das ärgerliche Abrollen auf der Arbeitsfläche. Die Präzisionsfläche erlaubt, den Schraubendreher schnell zwischen den Fingern zu drehen.

Mögliches Aufhängen dank des Lochs am Griff.

Das neue thermoplastische Gummi macht jeden Gebrauch noch komfortabler, auch bei schwersten Anwendungen.

Profil und Größe sind auf dem Kugelkopf aufgeführt, für eine schnelle Identifizierung.



Das ergonomische Design passt sich perfekt der Handfläche an. Dank der breiten Kontaktfläche kann mit niedrigstem Kraftaufwand die maximale Kraft übertragen werden.

Die geprüften Beta Klingen bieten Elastizität, Härte und Verschleißfestigkeit an der Spitze der Kategorie der professionellen Schraubendreher.

Der achteckige Querschnitt vermeidet das ärgerliche Abrollen auf der Arbeitsfläche.

Das neue thermoplastische Gummi macht jeden Gebrauch noch komfortabler, auch bei schwersten Anwendungen.

Mögliches Aufhängen dank des Lochs am Griff.



Profil und Größe sind auf dem Kugelkopf aufgeführt, für eine schnelle Identifizierung.

Die Präzisionsfläche erlaubt, den Schraubendreher schnell zwischen den Fingern zu drehen.

1201E Schraubendreher für Schlitzschrauben



ISO 2380

SxAxL mm	L1 mm	Ø mm	€		
0,4x2,5x50	146	2,5	4,70	5	012011003
0,4x2,5x75	166	2,5	4,80	5	012011006
0,5x3x75	171	3,0	5,00	5	012011009
0,5x3x100	196	3,0	5,30	5	012011012
0,6x3,5x75	171	3,5	5,30	5	012011018
0,6x3,5x100	196	3,5	5,50	5	012011021
0,8x4x100	196	4,0	5,50	5	012011030
0,8x4x125	221	4,0	5,80	5	012011033
0,8x4x150	246	4,0	6,40	5	012011036
1,0x5,5x100	209	5,0	6,90	5	012011039
1,0x5,5x125	234	5,0	7,30	5	012011040
1,0x5,5x150	259	5,0	7,40	5	012011042
1,2x6,5x100	220	6,0	8,20	5	012011048
1,2x6,5x125	234	6,0	8,50	5	012011050
1,2x6,5x150	270	6,0	8,70	5	012011051
1,2x8x150	282	8,0	11,10	3	012011057
1,2x8x200	332	8,0	11,90	3	012011060
1,6x10x200	332	9,5	13,80	3	012011066



1201E/S6	€		
0,5x3x75-0,6x3,5x100	47,00	1	012011206
0,8x4x100-1,0x5,5x100			
1,2x8x150-1,6x10x200 mm			

1201EN Schraubendreher für Schlitzschrauben, extrakurze Klinge



ISO 2380

SxAxL mm	L1 mm	Ø mm	€		
0,8x4x30	86,5	4	6,70	3	012011103
1,2x6,5x30	86,5	6	7,10	3	012011106

1201E/DZ

Schraubendreher für Dzus®-Schrauben



L mm	L1 mm	€	U	PC
53	173	16,40	2	012011501

1202E

Schraubendreher für Phillips®-Schrauben



UNI-ISO 8764

PHxDxL mm	L1 mm	€	U	PC
0x3x60	156	4,80	5	012021003
0x3x100	200	5,50	5	012021006
1x4,5x80	189	6,30	5	012021009
1x4,5x120	229	7,10	5	012021012
2x6x100	220	8,50	5	012021018
2x6x150	270	9,10	5	012021021
3x8x150	282	11,60	3	012021024
4x9,5x200	332	15,10	3	012021027



PHxDxL mm	L1 mm	€	U	PC
PH0x3x60-PH1x4,5x120-PH2x6x150-PH3x8x150 mm		33,00	1	012021204

1202EN

Schraubendreher für Phillips®-Schrauben, extrakurze Klinge



UNI-ISO 8764

PHxDxL mm	L1 mm	€	U	PC
1x4,5x30	86,5	6,70	3	012021103
2x6x30	86,5	7,10	3	012021106

1202EL

Schraubendreher für Phillips®-Schrauben, lange Klinge

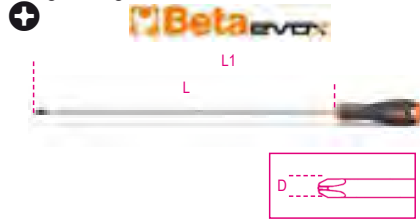

UNI-ISO 8764-1

PHxDxL mm	L1 mm	€	U	PC
0x3x300	400	8,70	3	012021303
1x4,5x300	400	9,40	3	012021305
1x4,5x400	508	11,40	3	012021306
2x6x400	519	13,10	3	012021309

1203E/D

Schraubendrehersatz



PHxDxL mm	L1 mm	€	U	PC
1203E/D5		36,00	1	012031001
1201E	0,6x3,5x100-1,0x5,5x150-1,2x6,5x150 mm			
1202E	PH1x4,5x80-PH2x6x100 mm			

PHxDxL mm	L1 mm	€	U	PC
1203E/D5PZ		35,00	1	012031003
1201E	0,5x3x75-0,8x4x125-1,0x5,5x150 mm			
1209E/PZ	PZ1x4,5x80-PZ2x6x100 mm			

PHxDxL mm	L1 mm	€	U	PC
1203E/D6		37,00	1	012031006
1202E	PH1x4,5x80-PH2x6x100 mm			
1204E	0,4x2,5x60-0,5x3x100-0,8x4x100-1,0x5x125 mm			

PHxDxL mm	L1 mm	€	U	PC
1203E/D7		45,00	1	012031007
1201E	0,5x3x75-0,8x4x100-1,0x5,5x100-1,2x6,5x150 mm			
1202E	PH0x3x60-PH1x4,5x80-PH2x6x100 mm			

PHxDxL mm	L1 mm	€	U	PC
1203E/D8		57,00	1	012031008
1201E	0,5x3x75-0,8x4x125-1,0x5,5x150-1,2x6,5x150 mm			
1202E	PH0x3x60-PH1x4,5x80-PH2x6x100-PH3x8x150 mm			

PHxDxL mm	L1 mm	€	U	PC
1203E/D8P		50,00	1	012031018
1201E	2,5x50-3x75-4x100-5,5x100-6,5x150 mm			
1202E	PH0x60-PH1x80-PH2x100 mm			

PHxDxL mm	L1 mm	€	U	PC
1203E/D10		72,50	1	012031010
1201E	0,4x2,5x50-0,5x3x75-0,8x4x100-1,0x5,5x100-1,2x6,5x150-1,2x8x150 mm			
1202E	PH0x3x60-PH1x4,5x80-PH2x6x100-PH3x8x150 mm			

PHxDxL mm	L1 mm	€	U	PC
1203E/D10N		63,00	1	012031019
1201E	0,4x2,5x50-0,5x3x75-0,8x4x100-1,0x5,5x150-1,2x6,5x150 mm			
1201EN	0,8x4x30 mm			
1202E	PH0x3x60 - PH1x4,5x80 - PH2x6x100 mm			
1202EN	PH1x4,5x30 mm			

1203E/S



PHxDxL mm	L1 mm	€	U	PC
1203E/S8		49,00	1	012031009
1201E	2,5x50-3x75-4x100-5,5x125-6,5x150 mm			
1202E	PH0x3x60-PH1x4,5x80-PH2x6x100 mm			

PHxDxL mm	L1 mm	€	U	PC
1203E/S10		72,50	1	012031021
1201E	0,4x2,5x50-0,5x3x75-0,8x4x125-1,0x5,5x150-1,2x6,5x150-1,2x8x150 mm			
1202E	PH0x3x60-PH1x4,5x80-PH2x6x100-PH3x8x150 mm			

1204E

Schraubendreher für Gewindestifte mit Schlitz



ISO 2380

SxDxL mm	L1 mm	€	U	PC
0,4x2,5x60	156	4,80	5	012041003
0,6x3x75	175	5,00	5	012041006
0,5x3x100	196	5,10	5	012041009
0,8x4x100	196	5,60	5	012041012
0,8x4x125	233	5,90	5	012041015
1x5x125	234	7,00	5	012041018
1x5x150	258	7,60	5	012041021
1,2x6,5x150	270	8,20	5	012041024



SxDxL mm	L1 mm	€	U	PC
1204E/S5		30,00	1	012041205
0,4x2,5x60-0,5x3x100-0,8x4x100-1x5x125-1,2x6,5x150 mm				

1204EL

Schraubendreher für Gewindestifte mit Schlitz, lange Klinge

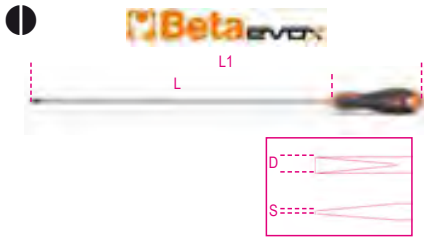

ISO 2380

SxDxL mm	L1 mm	€	📦	🚚
0,5x2,5x200	300	7,10	3	012041303
0,5x3x300	400	8,50	3	012041306
0,8x4x400	508	10,40	3	012041309
1x5x400	508	11,10	3	012041315
1,2x6,5x400	519	14,10	3	012041318

1205E/ES

Sechskant-Stiftschlüssel mit Griff



mm	L mm	L1 mm	€	📦	🚚
1,5	100	200	6,00	3	012051315
2	100	200	6,30	3	012051320
2,5	100	200	6,40	3	012051325
3	100	200	6,60	3	012051330
4	100	208	7,50	3	012051340
5	100	219	9,00	3	012051350
6	125	244	9,20	3	012051360
8	150	277	12,30	2	012051380



1205E/ES-S8 € 62,00 1 012051408
1,5-2-2,5-3-4-5-6-8 mm

1206E/BP

Sechskant-Stiftschlüssel mit kugelförmigem Kopf, mit Griff



mm	L mm	L1 mm	Ø mm	€	📦	🚚
2	100	198	2,5	6,80	3	012061320
2,5	100	198	3,0	6,90	3	012061325
3	100	198	3,5	7,00	3	012061330
4	100	209	5,0	7,90	3	012061340
5	100	220	6,0	9,40	3	012061350
6	125	245	7,0	9,70	3	012061360
8	150	287	9,5	12,90	2	012061380



1206E/BP-S7 € 59,50 1 012061407
2-2,5-3-4-5-6-8 mm

1207E/TX

Stiftschlüssel mit Griff, für Torx®-Schrauben



	L mm	L1 mm	Ø mm	€	📦	🚚
T5	50	150	3	7,30	5	012071005
T6	60	156	4	7,70	5	012071006
T7	60	156	4	7,90	5	012071007
T8	60	156	4	8,00	5	012071008
T9	60	156	4	8,40	5	012071009
T10	80	189	5	9,40	5	012071010
T15	80	189	5	9,50	5	012071015
T20	100	209	5	9,70	5	012071020
T25	100	209	5	10,00	5	012071025
T27	100	220	6	10,60	5	012071027
T30	100	220	6	10,70	5	012071030
T40	130	262	7	12,70	2	012071040
T45	130	262	8	13,90	2	012071045



1207E/TX-D7 € 64,50 1 012071207
T6-T8-T10-T15

1207E/TX-S13 € 125,00 1 012071213
T5-T6-T7-T8-T9-T10-T15
T20-T25-T27-T30-T40-T45

1208E/RTX

Stiftschlüssel mit Griff, für Sicherheitsschrauben Tamper Resistant Torx®



	L mm	L1 mm	Ø mm	€	📦	🚚
T9	60	156	4	8,50	5	012081009
T10	80	189	5	9,40	5	012081010
T15	80	189	5	10,00	5	012081015
T20	100	209	5	10,10	5	012081020
T25	100	209	5	10,40	5	012081025
T27	100	220	6	11,30	5	012081027
T30	100	220	6	11,80	5	012081030
T40	130	262	7	14,00	2	012081040



1208E/RTX-D7 € 71,00 1 012081207
T9-T10-T15-T20
T25-T27-T30

1209E/PZ

Schraubendreher für Pozidriv®-Supadriv®-Schrauben



UNI-ISO 8764

PZ	L mm	L1 mm	€	📦	🚚
0	60	156	5,60	5	012091000
1	80	189	7,40	5	012091003
2	100	220	9,40	5	012091006
3	150	282	14,30	3	012091009
4	200	327	15,70	3	012091012



1209E/PZ-S4 € 36,50 1 012091204
PZ0-PZ1-PZ2-PZ3

1209EN/PZ

Schraubendreher für Pozidriv®-Supadriv®-Schrauben, extrakurze Klinge



ISO 8764

PZ	L mm	L1 mm	€	📦	🚚
1	30	87	6,70	3	012091103
2	30	87	7,10	3	012091106

Beta **EVOX-E**

ELEKTRISCHER SCHRAUBENDREHER BETA EVOX-E

Der elektrische Schraubendreher Beta Evox-E ist ideal für hochpräzises Arbeiten bei minimalem Kraftaufwand und maximaler Geschwindigkeit.



ZWECKMÄSSIGKEIT

Die geringen Abmessungen erleichtern das Schrauben in engen Räumen und die Front-LEDs sorgen für eine hervorragende Sichtbarkeit des Arbeitspunktes.

ERGONOMIE

Der Griff liegt perfekt, bequem und fest in der Hand.

1/4



Betriebsdauer

Der Lithium-Akku mit 3,7 V 2300 mAh garantiert das Anziehen von bis zu 1.000 Schrauben mit einer einzigen Ladung.

Er ist in zwei Ausführungen erhältlich:

- Elektrischer Schraubendreher 1210E/GE mit Schraubeinsätzen



- Elektrischer Schraubendreher 1211E/GE mit 1000V-isolierten Schraubeinsätzen



1000 V



1210E/GE

Elektrischer Schraubendreher Evox-E



L
mm
150

€ 197,00 1 012100701

1211E/GE

Elektrischer Schraubendreher Evox-E



L
mm
150

€ 210,00 1 012110701



1229LP/A6
1,2-1,4-1,8-2-2,4-3 mm

€ 30,00 1 012290300

1229LPH/A6

Elektronikschraubendreher für Phillips®-Schrauben



1229LPH/A6
1229LP 1,4-2,0-2,4-3 mm
1229PH PH0-PH1

€ 30,00 1 012290310

1236B

Winkelschraubendreher für Schlitzschrauben

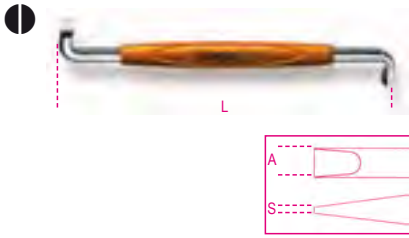

UNI 7079 DIN 5200

SxA	L	€		
mm	mm			
0,8x4	100	8,60	5	012360201
1x5,5	125	10,10	5	012360202
1,2x8	150	12,60	5	012360204

1238B

Winkelschraubendreher für Phillips®-Schrauben



UNI 7083 DIN 5208

PH	L	€		
	mm			
1-2	125	10,30	5	012380201
3-4	200	16,60	5	012380203

1241

Schraubendreher mit Stahlkopf für Schlitzschrauben

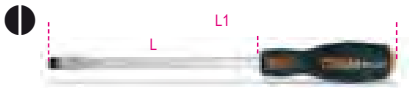

ISO 2380

SxAxL	L1	€		
mm	mm			
1x5,5x100	202	13,40	5	012410039
1,2x6,5x125	240	14,90	5	012410050
1,2x8x150	268	18,10	3	012410057
1,6x10x175	300	22,70	2	012410065
1,6x10x200	325	23,20	2	012410066
2,0x12x200	325	24,40	2	012410067
2,5x14x250	375	27,00	2	012410076



1242

Schraubendreher mit Stahlkopf für Phillips®-Schrauben



UNI/ISO 8764

PHxDxL	L1	€		
mm	mm			
1x4,5x100	202	13,20	5	012420209
2x6x100	215	15,70	5	012420218
3x8x150	268	20,00	3	012420221
4x11x200	325	26,00	2	012420224

1243LP/D6

Schraubendrehersatz, 6-teilig, mit Stahlkopf, für Schlitzschrauben



	€		
1243LP/D6	121,00	1	012430016
1241			
			1x5,5x100-1,2x6,5x125
			3x8x150-1,6x10x175
			2,0x12x200-2,5x14x250 mm

1243/D7

Schraubendrehersatz, 7-teilig, mit Stahlkopf



	€		
1243/D7	119,00	1	012430017
1241			1x5,5x100-1,2x6,5x125
			1,2x8x150-1,6x10x200 mm
1242			PH1x4,5x100-PH2x6x100
			PH3x8x150 mm

1243/S11

Schraubendrehersatz, 11-teilig, mit Stahlkopf



	€		
1243/S11	218,00	1	012430021
1241			1x5,5x100-1,2x6,5x125
			3x8x150-1,6x10x175
			1,6x10x200-2,0x12x200
			2,5x14x250 mm
1242			PH1x4,5x100-PH2x6x100
			PH3x8x150-PH4x11x200 mm

1250

Festhalteschraubendreher für Schlitzschrauben

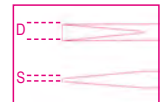

SxDxL	L1	€		
mm	mm			
0,5x3x125	190	19,10	5	012500030
0,6x4x125	225	20,60	5	012500040
0,7x5x150	255	24,30	5	012500050

1251

Festhalteschraubendreher für Phillips®-Schrauben



PHxDxL	L1	€		
mm	mm			
0x4x125	225	21,50	5	012510000
1x5x125	225	24,80	5	012510010
2x6x175	280	28,00	5	012510020

1252/S5



	€		
1252/S5	118,00	1	012520001
1250			0,5x3x125-0,6x4x125
			0,7x5x150 mm
1251			PH1x5x100-PH2x6x175 mm

1253

Schraubendreher mit Spannungsprüfer - 150/250V

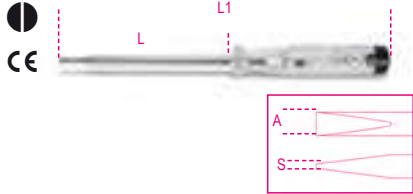

SxAxL mm	L1 mm	€	U	IP
0,5x3,5x100	190	11,60	5	012530001

1253A

Schraubendreher mit Spannungsprüfer - 125/250V, mit doppelter Isolierung

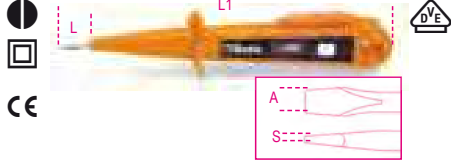

SxAxL mm	L1 mm	€	U	IP
0,5x3x15	150	8,30	5	012530010

1254

Schraubendreher mit Spannungsprüfer, 6-24 V

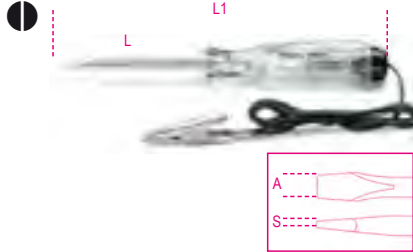

SxAxL mm	L1 mm	€	U	IP
0,5x3x44	123	12,70	5	012540001

1256/C36-2

Elektronikschraubendreher mit 36 austauschbaren 4 mm Bits und Magnetverlängerung



1256/C36-2	€	U	IP
	81,50	1	012560100

- 1256TX T3 - T4 - T5 - T6 - T7 T8 - T9 - T10 - T15
 - 1256RTX T6 - T7 - T8 - T9 - T10
 - 1256LP 0,8 - 1,2 - 1,5 - 1,8 - 2 - 2,5 3 - 3,5 - 4 mm
 - 1256PE 0,7 - 0,9 - 1,3 - 1,5 - 2 mm
 - 1256PH PH000 - PH00 - PH0 - PH1
 - 1256PZ PZ000 - PZ00 - PZ0 - PZ1
 - 1256/20
 - 1256/30
- 130x60x35 mm - 200 g

1256LP

4 mm Einsätze für Schraubendreher für Schlitzschrauben

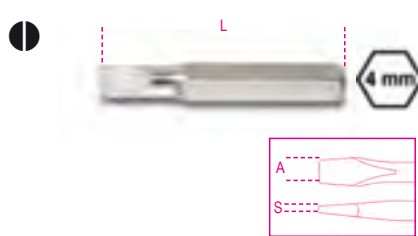

SxA mm	L mm	€	U	IP
0,25x0,8	27	1,70	5	012560001
0,25x1,2	27	1,70	5	012560002
0,3x1,5	27	1,70	5	012560003
0,35x1,8	27	1,70	5	012560004
0,4x2,0	27	1,70	5	012560005
0,4x2,5	27	1,70	5	012560006
0,5x3,0	27	1,70	5	012560007
0,6x3,5	27	1,70	5	012560008
0,8x4,0	27	1,70	5	012560009

1256PH

4 mm Einsätze für Phillips®-Schrauben



PH	L mm	€	U	IP
000	27	1,70	5	012560011
00	27	1,70	5	012560012
0	27	1,70	5	012560013
1	27	1,70	5	012560014

1256PZ

4 mm Einsätze für Pozidriv®-Supradriv®-Schrauben



PZ	L mm	€	U	IP
000	27	1,70	5	012560061
00	27	1,70	5	012560062
0	27	1,70	5	012560063
1	27	1,70	5	012560064

1256PE

4 mm Einsätze für Sechskantschrauben



mm	L mm	€	U	IP
0,7	27	1,70	5	012560021
0,9	27	1,70	5	012560022
1,3	27	1,70	5	012560023
1,5	27	1,70	5	012560024
2,0	27	1,70	5	012560025

1256TX

4 mm Einsätze für Torx®-Schrauben



T	L mm	€	U	IP
T3	27	1,70	5	012560041
T4	27	1,70	5	012560042
T5	27	1,70	5	012560043
T6	27	1,70	5	012560044
T7	27	1,70	5	012560045
T8	27	1,70	5	012560046
T9	27	1,70	5	012560047
T10	27	1,70	5	012560048
T15	27	1,70	5	012560049

1256RTX

4 mm Einsätze für Sicherheitsschrauben Tamper Resistant Torx®



T	L mm	€	U	IP
T6	27	2,10	5	012560051
T7	27	2,10	5	012560052
T8	27	2,10	5	012560053
T9	27	2,10	5	012560054
T10	27	2,10	5	012560055

1256/20

Verlängerung, Innen- und Außensechskant, 4 mm



1256/20	€	U	IP
	10,00	5	012560092

1256/30

4 mm Einsatzhalter mit Griff

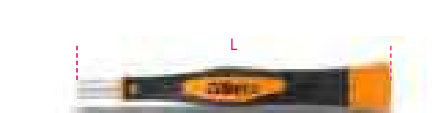

L mm	€	U	IP
110	11,80	2	012560097

1257LP

Elektronikschraubendreher für Gewindestifte mit Schlitz

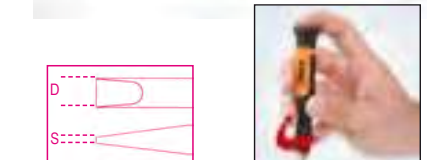

SxD mm	L mm	€	U	IP
0,25x1,2	60	6,40	5	012570012
0,23x1,5	60	6,40	5	012570015
0,3x1,8	60	6,40	5	012570018
0,4x2	60	6,40	5	012570020
0,4x2,5	60	6,40	5	012570024

SxD mm	L mm	€		
0,5x3	60	6,40	5	012570030
0,6x3,5	60	6,40	5	012570035
0,8x4	60	6,40	5	012570040



1257LP/S8	€		
78,50	1	012570200	
0,2x1,2-0,25x1,5			
0,3x1,8-0,4x2-0,4x2,5			
0,5x3-0,6x3,5-0,8x4 mm			

1257PH

Elektronikschraubendreher
für Phillips®-Schrauben



PH	L mm	€		
00	60	6,40	5	012570060
0	60	6,40	5	012570063
1	60	6,40	5	012570066

1257LPH/S8



1257LPH/S8	€		
78,50	1	012570210	
1257PH PH00-PH0-PH1			
1257LP 0,4x2-0,4x2,5-0,5x3			
0,6x3,5-0,8x4 mm			



1257ES

Sechskant-Elektronikschraubendreher



mm	L mm	€		
0,9	60	7,10	5	012570045
1,3	60	7,10	5	012570046
1,5	60	7,10	5	012570047
2	60	7,10	5	012570048
2,5	60	7,10	5	012570049
3	60	7,10	5	012570050

1257ESB/S8



1257ESB/S8	€		
89,50	1	012570230	
1257ES 0,9-1,3-1,5-2-2,5-3 mm			
1257BE 4-5 mm			

1257TX

Elektronikschraubendreher
für Torx®-Schrauben



T	L mm	€		
T5	60	7,50	5	012570075
T6	60	7,50	5	012570076
T7	60	7,50	5	012570077
T8	60	7,50	5	012570078
T9	60	7,50	5	012570079
T10	60	7,50	5	012570080
T15	60	7,50	5	012570081
T20	60	7,50	5	012570082



1257TX/S8	€		
87,50	1	012570220	
T5-T6-T7-T8			
T9-T10-T15-T20			

1257BE

Sechskant-Elektronikschraubendreher



mm	L mm	€		
3,2	60	9,40	5	012570085
4	60	9,40	5	012570086
5	60	9,40	5	012570087
5,5	60	9,40	5	012570088





Die BetaGrip-Schraubendreher sind das Ergebnis der langjährigen Erfahrung von Beta bei der Entwicklung von Schraubendrehern und der engen Zusammenarbeit mit den Mechanikern Motorrennsportteams.

Neue, einzigartige technische Lösungen, die den Anforderungen der anspruchsvollsten Profis gerecht werden, wurden eingesetzt, um die höchsten Standards in Bezug auf Ergonomie, Beständigkeit und Qualität der Materialien zu erzielen.

- Die Klinge ist aus Spezialstahl mit hohem Silizium-, Chrom- und Vanadiumgehalt gefertigt, um eine verbesserte Leistung in Bezug auf die Torsions- und Biegefestigkeit zu gewährleisten. Es wurde eine blendfreie, mattverchromte Oberfläche gewählt.

- Die Geometrie der Spitze wurde so gestaltet, dass eine perfekte Kopplung zwischen der Klinge und dem Schraubenkopf gewährleistet ist. Die phosphatierte Oberfläche verhindert, dass die Spitze oxidiert, während die Präzision der Profile erhalten bleibt.

- Die Textur wurde von den Profilen von Rennreifen inspiriert, die entwickelt wurden, um die Griffigkeit auf verschiedenen Untergründen zu maximieren. So gewährleistet sie einen effektiven Halt des Schraubendrehers unter allen Arbeitsbedingungen und sorgt für mehr Präzision und Kontrolle beim Aufsetzen der Spitze auf die Schraube.



1260

Schraubendreher für Schlitzschrauben



ISO 2380

SxAxL mm	L1 mm	Ø mm	€	U	U
0,4x2,5x50	150	2,5	6,50	5	012600003
0,4x2,5x75	175	2,5	6,70	5	012600006
0,5x3x75	175	3,0	6,90	5	012600009
0,5x3x100	200	3,0	7,10	5	012600012
0,6x3,5x75	175	3,5	7,40	5	012600018
0,6x3,5x100	200	3,5	7,50	5	012600021
0,8x4x100	208	4,0	8,20	5	012600030
0,8x4x125	233	4,0	8,50	5	012600033
0,8x4x150	258	4,0	8,90	5	012600036
1x5,5x100	208	5,0	9,40	5	012600039
1x5,5x125	233	5,0	9,60	5	012600040
1x5,5x150	258	5,0	10,40	5	012600042
1,2x6,5x100	219	6,0	11,30	5	012600048
1,2x6,5x125	244	6,0	11,70	5	012600050
1,2x6,5x150	269	6,0	12,10	5	012600051
1,2x8x150	277	8,0	14,80	3	012600057
1,2x8x200	327	8,0	15,20	3	012600060
1,6x10x200	327	9,5	18,50	3	012600066
2x12x250	377	10	21,90	3	012600069
2x14x250	377	10	23,20	2	012600073



1260/S6	€	U	U
0,4x2,5x75-0,5x3x75-0,8x4x125 1x5,5x150-1,2x6,5x150-1,2x8x200 mm	59,50	1	012600306

1260N

Schraubendreher für Schlitzschrauben, extrakurze Klinge

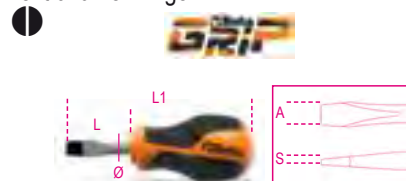

ISO 2380

SxAxL mm	L1 mm	Ø mm	€	U	U
0,8x4x30	87	4	8,60	5	012600103
1,2x6,5x30	87	6	9,60	5	012600106



1260E

Schraubendreher für Schlitzschrauben, Klingen mit Sechskant



ISO 2380

SxAxL mm	L1 mm	Ø mm	€		
1,2x6,5x150	269	6,0	15,70	3	012600156
1,2x8x175	301	8,0	19,30	3	012600157
1,6x10x200	327	9,5	22,30	2	012600159
2x12x250	377	9,5	26,00	2	012600162

1260MC

Schraubendreher für Schlitzschrauben, farbig



SxAxL mm	L1 mm	Ø mm	€		
0,4x2,5x50	150	2,5	7,00	3	012602003
0,6x3,5x75	175	3,5	7,30	3	012602018
0,8x4x100	208	4,0	8,60	3	012602030
1x5,5x150	233	5,0	11,10	5	012602040
1,2x6,5x150	269	6,0	12,80	5	012602051

1262

Schraubendreher für Phillips®-Schrauben



UNI/ISO 8764

PHxDxL mm	L1 mm	€		
0x3x60	160	6,90	5	012620003
0x3x100	200	7,40	5	012620006
1x4,5x80	188	9,10	5	012620009
1x4,5x120	228	9,90	5	012620012
2x6x100	219	11,20	5	012620018
2x6x150	269	12,30	5	012620021
3x8x150	277	16,30	3	012620024
4x10x200	327	20,80	3	012620027



1262/S4	€		
PH0x3x60-PH1x4,5x80 PH2x6x100-PH3x8x150 mm	43,00	1	012620304

1262N

Schraubendreher für Phillips®-Schrauben, extrakurze Klinge



UNI/ISO 8764

PHxDxL mm	L1 mm	€		
1x4,5x30	87	8,60	5	012620103
2x6x30	87	9,60	5	012620106

1262E

Schraubendreher für Phillips®-Schrauben, Klinge mit Sechskant



UNI/ISO 8764

PHxDxL mm	L1 mm	€		
2x6x150	269	15,70	3	012620153
3x8x175	302	19,00	3	012620156
4x10x200	327	23,90	2	012620159

1262L

Schraubendreher für Phillips®-Schrauben, lange Klinge



UNI/ISO 8764-1

PHxDxL mm	L1 mm	€		
0x3x300	400	11,90	3	012620203
1x4,5x300	400	14,20	3	012620205
1x4,5x400	508	16,50	3	012620206
2x6x400	519	21,50	3	012620209

1262MC

Schraubendreher für Phillips®-Schrauben, farbig



PHxDxL mm	L1 mm	€		
0x3x60	160	7,30	3	012622003
1x4,5x80	188	9,40	3	012622009
2x6x100	219	11,70	3	012622018

1263/D...

Schraubendrehersatz



1263/D6	€		
1260 0,5x3x75-0,8x4x100 1x5,5x125-1,2x6,5x150 mm	56,00	1	012630006
1262 PH1x4,5x80-PH2x6x100 mm			



1263/D7	€		
1262 PH0x3x60 PH1x4,5x80 PH2x6x100 mm	58,00	1	012630017
1264 0,5x2,5x60-0,6x3x100 0,8x4x125-1x5x125 mm			



1263/D7PZ	€		
1260 0,5x3x75-0,8x4x100 1x5,5x150-1,2x6,5x150 mm	67,50	1	012630007
1269PZ PZ0 - PZ1 - PZ2			



1263/D8	€		
1260 0,4x2,5x50-0,5x3x75 0,8x4x100-1x5,5x125 1,2x6,5x150 mm	70,00	1	012630008
1262 PH0x3x60-PH1x4,5x80 PH2x6x100 mm			



1263/D10	€		
1260 0,5x3x75-0,6x3,5x100 0,8x4x125-1x5,5x150 1,2x6,5x150 mm	89,50	1	012630010
1260N 0,8x4x30			
1262 PH0x3x60-PH1x4,5x80 PH2x6x100 mm			
1262N PH1x4,5x30			

1263/S12

Schraubendrehersatz, 12teilig



1263/S12		€	U	1	012630112
1260	0,4x2,5x50-0,5x3x75 0,6x3,5x100-0,8x4x125 1x5,5x125-1,2x6,5x150 1,2x8x200-1,6x10x200 mm	128,00			
1262	PH0x3x60-PH1x4,5x80 PH2x6x100-PH3x8x150 mm				

1263MC/D8

Schraubendrehersatz, 8-teilig, farbig



1263MC/D8		€	U	1	012632008
1260MC	0,4x2,5x50-0,5x3x75 0,8x4x100-1x5,5x125 1,2x6,5x150 mm	74,50			
1262MC	PH0x3x60-PH1x4,5x80 PH2x6x100 mm				

1264

Schraubendreher für Gewindestifte mit Schlitz



SxDxL mm	L1 mm	€	U	1	012640003
0,5x2,5x60	160	6,50		5	012640003
0,6x3x75	175	6,90		5	012640006
0,6x3x100	200	7,10		5	012640009
0,8x4x100	208	8,20		5	012640012
0,8x4x125	233	8,50		5	012640015
1x5x125	233	9,60		5	012640018
1x5x150	258	10,10		5	012640021
1,2x6,5x150	269	12,10		5	012640024



1264/S5		€	U	1	012640305
0,5x2,5x60-0,6x3x75 0,8x4x100-1x5x125-1,2x6,5x150 mm		43,00			

1264L

Schraubendreher für Gewindestifte mit Schlitz, lange Klinge

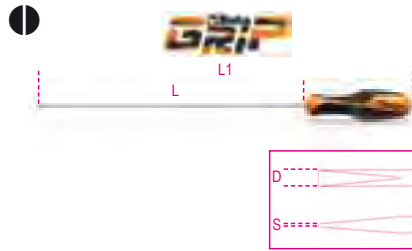

SxDxL mm	L1 mm	€	U	1	012640203
0,5x2,5x200	300	9,70		3	012640203
0,6x3x300	400	11,40		3	012640206
0,8x4x400	508	14,80		3	012640209
1x5x400	508	16,50		3	012640215
1,2x6,5x400	519	20,00		3	012640218

1265ES

Sechskant-Stiftschlüssel mit Griff



mm	L mm	L1 mm	€	U	1	012650015
1,5	100	200	7,90		3	012650015
2	100	200	8,20		3	012650020
2,5	100	200	8,40		3	012650025
3	100	200	8,90		3	012650030
4	100	208	9,80		3	012650040
5	100	219	11,30		3	012650050
6	125	244	12,80		3	012650060
8	150	277	16,80		2	012650080



1265ES/S8		€	U	1	012650308
1,5-2-2,5-3-4-5-6-8 mm		83,00			

1266BP

Sechskant-Stiftschlüssel mit kugelförmigem Kopf, mit Griff



mm	L mm	L1 mm	€	U	1	012660020
2	100	200	8,60		3	012660020
2,5	100	200	9,00		3	012660025
3	125	225	9,40		3	012660030
4	125	233	10,40		3	012660040
5	120	239	12,10		3	012660050
6	140	259	14,00		3	012660060
8	160	287	17,60		2	012660080
10	160	287	21,10		2	012660100



1266BP/S8		€	U	1	012660308
2-2,5-3-4-5-6-8-10 mm		102,00			

1267TX

Stiftschlüssel mit Griff, für Torx®-Schrauben



Ø	L mm	L1 mm	Ø mm	€	U	1	012670005
T5	50	150	3	9,70		5	012670005
T6	50	150	3	10,10		5	012670006
T7	50	150	3	10,40		5	012670007
T8	60	160	3	10,90		5	012670008
T9	60	167	4	11,40		5	012670009
T10	80	188	4	11,80		5	012670010
T15	80	188	4	12,50		5	012670015
T20	100	208	4,5	13,10		5	012670020
T25	100	208	5	14,20		5	012670025
T27	115	234	6	14,80		5	012670027
T30	115	234	6	15,60		5	012670030
T40	130	257	7	18,00		2	012670040
T45	130	257	8	19,80		2	012670045



1267TX/D7 € 88,00 1 012670307
T6-T8-T10-T15
T20-T25-T30



1267TX/S13 € 172,00 1 012670312
T5-T6-T7-T8-T9
T10-T15-T20-T25
T27-T30-T40-T45

1267MC/TX

Stiftschlüssel mit Griff, für Torx®-Schrauben, farbig



Ø	L mm	L1 mm	Ø mm	€	Stk	Art-Nr
T6	50	150	3	10,70	5	012672006
T8	60	160	3	11,30	5	012672008
T10	80	188	4	12,60	5	012672010
T15	80	188	4	13,10	5	012672015
T20	100	208	4,5	14,00	5	012672020
T25	100	208	5	14,70	3	012672025
T30	115	234	6	16,10	3	012672030



1267MC/TX-D7 € 91,50 1 012672307
T6-T8-T10-T15
T20-T25-T30

1268RTX

Stiftschlüssel mit Griff, für Sicherheitsschrauben Tamper Resistant Torx®



Ø	L mm	L1 mm	Ø mm	€	Stk	Art-Nr
T9	60	167	4,0	12,30	3	012680009
T10	80	188	4,0	12,80	3	012680010
T15	80	188	4,0	13,10	3	012680015
T20	100	208	4,5	14,20	3	012680020
T25	100	208	5,0	14,60	3	012680025
T27	115	234	6,0	15,60	3	012680027
T30	115	234	6,0	15,80	3	012680030
T40	130	257	7,0	18,30	2	012680040



1268RTX/S8 € 117,00 1 012680307
T9-T10-T15-T20
T25-T27-T30-T40

1269PZ

Schraubendreher für Pozidriv®- und Supadriv®-Schrauben



UNI/ISO 8764

PZ	L mm	L1 mm	€	Stk	Art-Nr
0	60	160	7,90	5	012690000
1	80	188	10,30	5	012690001
2	100	219	12,50	5	012690002
3	150	277	17,60	3	012690003
4	200	327	22,50	3	012690004



1269PZ/S4 € 48,00 1 012690304
PZ0-PZ1-PZ2-PZ3

1269N/PZ

Schraubendreher für Pozidriv®- und Supadriv®-Schrauben, extrakurze Klinge



UNI/ISO 8764

PZ	L mm	L1 mm	€	Stk	Art-Nr
1	30	87	8,60	5	012690011
2	30	87	9,60	5	012690012

1281BG

Klingenhalter



L mm	Ø mm	€	Stk	Art-Nr
118	10	14,40	5	012810280

1281PM

Magnetischer Schraubeinsatzhalter



L mm	€	Stk	Art-Nr
165	24,60	5	012810292

1281PB

Steckschlüsselhalter, Außenvierkant 1/4"



L mm	€	Stk	Art-Nr
175	19,70	5	012810293

1281LP

Umsteckbare Klingen für Schlitzschrauben



Art-Nr	€	Stk	Art-Nr
1281LP/1	12,80	5	012810302
0,8x4-1,2x6,5 mm			
1281LP/2	12,80	5	012810304
1x5,5-1,2x6,5 mm			

1281PH

Umsteckbare Klingen für Phillips®-Schrauben



PH	€	5	012810310
1-2	12,80	5	012810310
2-3	12,80	5	012810312

1281LPH

Umsteckbare Klingen für Schlitz- und Phillips®-Schrauben



	€	5	012810321
1281LPH/1 PH0-0,8x4 mm	12,80	5	012810321
1281LPH/2 PH1-1x5,5 mm	12,80	5	012810322
1281LPH/3 PH2-1,2x6,5 mm	12,80	5	012810323

1281PZ

Umsteckbare Klingen für Pozidriv®- und Supadriv®-Schrauben



PZ	€	5	012810330
1-2	12,80	5	012810330
2-3	12,80	5	012810332

1281PE

Umsteckbare Klingen mit einem kugelförmigen Kopf



mm	€	5	012810342
2,5	12,70	5	012810342
3	12,70	5	012810343
4	12,70	5	012810344
5	12,70	5	012810345
6	12,70	5	012810346

1281TX

Umsteckbare Klingen für Torx®-Schrauben



	€	5	012810349
1281TX/1 T6-T8	13,90	5	012810349
1281TX/2 T7-T9	13,90	5	012810350
1281TX/3 T10-T15	13,90	5	012810351
1281TX/4 T20-T25	13,90	5	012810352
1281TX/5 T30-T40	13,90	5	012810353

1281RTX

Umsteckbare Klingen für Sicherheitschrauben
Tamper Resistant Torx®



	€	5	012810361
1281RTX/3 T10-T15	14,10	5	012810361
1281RTX/4 T20-T25	14,10	5	012810362
1281RTX/5 T30-T40	14,10	5	012810363

1281BG/A9

Sortiment aus 9 umsteckbaren Klingen und 1 Betätigungswerkzeug, mit Etui



1281BG/A9	€	1	012810520
1281BG/A9	148,00	1	012810520

1281BG	
1281LPH/1	PH0-0,8x4 mm
1281LPH/2	PH1-1x5,5 mm
1281LPH/3	PH2-1,2x6,5 mm
1281PZ/1	PZ1-PZ2
1281PE	2,5 mm
1281PE	3 mm
1281PE	4 mm
1281PE	5 mm
1281PE	6 mm

1281BG-TX/A8

Sortiment aus 8 umsteckbaren Klingen und 1 Betätigungswerkzeug, mit Etui



1281BG-TX/A8	€	1	012810530
1281BG-TX/A8	142,00	1	012810530

1281BG	
1281LPH/1	PH0-0,8x4 mm
1281LPH/2	PH1-1x5,5 mm
1281LPH/3	PH2-1,2x6,5 mm
1281TX/1	T6-T8
1281TX/2	T7-T9
1281TX/3	T10-T15
1281TX/4	T20-T25
1281TX/5	T30-T40

1281BG/B28NA

Sortiment aus 16 umsteckbaren Klingen, 9 Steckschlüsseln 1/4", 2 Betätigungswerkzeugen und 1 Klingenhalter, in Tasche aus strapazierfähigem Polyester



1281BG/B28NA	€	1	012810511
1281BG/B28NA	325,00	1	012810511

900	4 - 4,5 - 5 - 5,5 6 - 7 - 8 - 9 - 10 mm
1281BG	
1281PB	■ 1/4
900/25	
1281LP/1	0,8x4 - 1,2x6,5 mm
1281LP/2	1,0x5,5 - 1,2x6,5 mm
1281PH/1	PH1 - PH2
1281PH/2	PH2 - PH3
1281PZ/1	PZ1 - PZ2
1281PZ/2	PZ2 - PZ3
1281PE	2,5 - 3 - 4 - 5 - 6 mm
1281TX/1	T6 - T8
1281TX/2	T7 - T9
1281RTX/3	T10 - T15
1281RTX/4	T20 - T25
1281RTX/5	T30 - T40

2002/BV7-ZIP	€	1	020020060
2002/BV7-ZIP	24,50	1	020020060

Die BetaMax-Schraubendreher weisen zahlreiche technische Eigenschaften auf, um die Arbeitsvorgänge noch einfacher zu gestalten.

- Der Griff ist durch den dreieckigen Querschnitt inspiriert, der den Vorteil einer optimalen Verschraubung bietet, basierend auf einem 120°-Bereich, in Übereinstimmung mit der maximalen Drehung des Handgelenks.
- Das Design bietet bemerkenswerte ergonomische Eigenschaften, sowohl bei schnellen Schraubvorgängen als auch beim Anziehen.
- Die verchromungsfreie Spitze gewährleistet eine perfekte Verbindung mit der Schraube und ist durch eine Phosphatierung gegen Rost geschützt.

1290 Schraubendreher für Schlitzschrauben

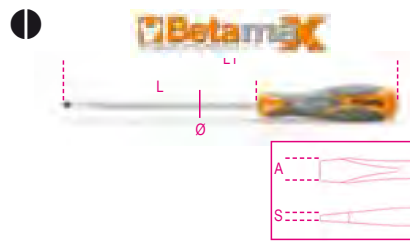

ISO 2380

SxAxL mm	L1 mm	Ø mm	€	🔧	📄
0,4x2,5x50	146	2,5	8,30	5	012900003
0,4x2,5x75	171	2,5	8,60	5	012900006
0,5x3x75	171	3,0	8,80	10	012900009
0,5x3x100	196	3,0	9,20	10	012900012
0,6x3,5x75	171	3,5	10,00	10	012900018
0,6x3,5x100	196	3,5	10,10	10	012900021
0,8x4x100	196	4,0	10,20	10	012900030
0,8x4x125	221	4,0	10,50	10	012900033
0,8x4x150	246	4,0	11,30	10	012900036
1x5,5x100	209	5,0	11,40	10	012900039
1x5,5x150	259	5,0	12,90	10	012900042
1,2x6,5x100	220	6,0	14,30	10	012900048
1,2x6,5x150	270	6,0	15,10	10	012900051
1,2x8x150	282	7,0	18,90	3	012900057
1,2x8x200	332	7,0	20,00	3	012900060
1,6x10x200	332	8,0	23,40	3	012900066
2x12x250	382	10	31,00	2	012900069

1290/S Schraubendrehersatz



1290/S5	€	🔧	📄
1290 0,5x3x75-0,8x4x100 -1x5,5x150 1,2x6,5x150 -1,2x8x150 mm	66,00	1	012900305

1290/S9X	€	🔧	📄
1290 0,4x2,5x75 - 0,5x3,5x100 0,8x4x125 - 1x5,5x150 1,2x6,5x150 - 1,2x8x200 1,6x10x200 mm	122,50	1	012900319
1290N 0,8x4x30 -1,2x6,5x30 mm			

1290N Schraubendreher für Schlitzschrauben, extrakurze Ausführung



ISO 2380

SxAxL mm	L1 mm	Ø mm	€	🔧	📄
0,8x4x30	86	4	10,80	5	012900103
1,2x6,5x30	86	6	12,10	5	012900106

1292 Schraubendreher für Phillips®-Schrauben

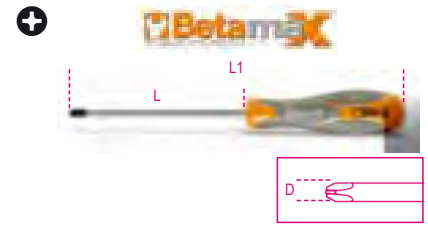

UNI/ISO 8764

PHxDxL mm	L1 mm	€	🔧	📄
0x3x60	156	8,00	10	012920003
0x3x100	196	9,10	5	012920006
1x4,5x80	189	10,90	10	012920009
1x4,5x120	229	12,20	10	012920012
2x6x100	220	14,50	10	012920018
2x6x150	270	15,50	10	012920021
3x8x150	282	19,80	3	012920024
4x10x200	332	27,00	3	012920027



1292/S4	€	🔧	📄
PH0x3x60-PH1x4,5x80 PH2x6x100-PH3x8x150 mm	52,50	1	012920304

1292N Schraubendreher für Phillips®-Schrauben, extrakurze Ausführung



UNI/ISO 8764

PHxDxL mm	L1 mm	€	🔧	📄
1x4,5x30	86	10,30	5	012920103
2x6x30	86	11,30	5	012920106

1292L Schraubendreher für Phillips®-Schrauben, lange Ausführung

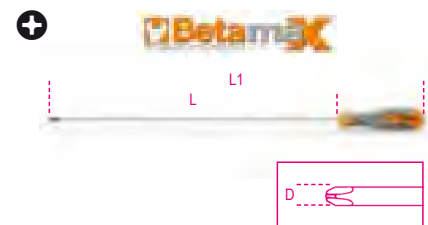

UNI/ISO 8764-1

PHxDxL mm	L1 mm	€	🔧	📄
0x3x300	396	17,60	3	012920203
1x4,5x400	509	21,70	3	012920206
2x6x400	520	26,50	3	012920209



1293/D...

Schraubendrehersatz



1293/D6 € 70,00 1 012930401

1290 0,6x3,5x75-1x5,5x150
1,2x6,5x150 mm
1292 PH0x3x60 -PH1x4,5x80
PH2x6x100 mm

1293/D8 € 98,50 1 012930403

1290 0,5x3x75-0,8x4x100
1x5,5x150-1,2x6,5x150
1,2x8x150 mm
1292 PH0x3x60 -PH1x4,5x80
PH2x6x100 mm

1293/S...

Schraubendrehersatz



1293/S8 € 88,00 1 012930208

1290 2,5x50-3x75-4x100-5,5x150
6,5x150 mm
1292 PH0x3x60 -PH1x4,5x80
PH2x6x100 mm

1293/S10 € 140,50 1 012930201

1290 0,4x2,5x50 -0,6x3,5x100
1x5,5x100-1,2x6,5x150
1,2x8x150-1,6x10x200 mm
1292 PH0x3x60 -PH1x4,5x80
PH2x6x100-PH3x8x150 mm

1293/S12 € 153,00 1 012930203

1290 0,5x3x75-0,8x4x125
1x5,5x150-1,2x6,5x150
1,2x8x200 mm
1290N 0,8x4x30 mm
1292 PH0x3x60 -PH1x4,5x80
PH2x6x100-PH3x8x150 mm
1292N PH1x4,5x30-PH2x6x30 mm

1293/S7 € 72,00 1 012930207

1292 PH0x3x60 -PH1x4,5x80
PH2x6x100 mm
1294 0,5x2,5x60-0,6x3x75
0,8x4x100-1x5x125 mm



1293ES

Sechskant-Stiftschlüssel mit Griff



mm	L mm	L1 mm	Ø mm	€	U	M
2	100	196	3	11,30	5	012930001
2,5	100	196	4	11,30	5	012930002
3	100	196	4	11,50	5	012930003
4	100	196	5	13,10	5	012930004
5	100	209	6	14,50	5	012930005
6	125	245	7	16,40	5	012930006
8	150	282	10	21,70	2	012930008



1293ES/S7 € 99,50 1 012930057
2-2,5-3-4-5-6-8 mm

1293BP

Sechskant-Stiftschlüssel
mit kugelförmigem Kopf, mit Griff

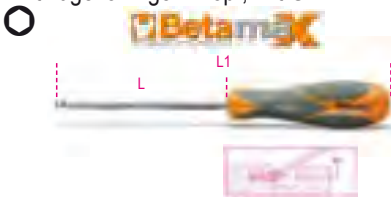

mm	L mm	L1 mm	€	U	M
2	100	196	11,30	5	012930501
2,5	100	196	11,30	5	012930502
3	100	196	11,60	5	012930503
4	100	196	13,10	5	012930506
5	100	209	14,50	5	012930509
6	125	245	16,80	5	012930512
8	150	282	22,70	2	012930515



1293BP/S7 € 101,00 1 012930558
2-2,5-3-4-5-6-8 mm

1294

Schraubendreher für Gewindestifte
mit Schlitz

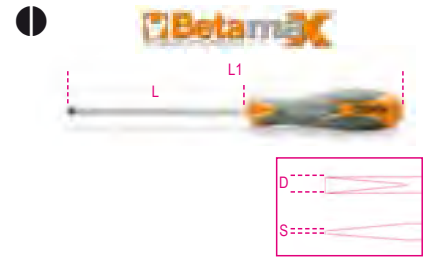

SxDxL mm	L1 mm	€	U	M
0,5x2,5x60	156	7,90	5	012940003
0,6x3x75	171	8,20	5	012940006
0,6x3x100	196	8,40	5	012940009
0,8x4x100	196	10,20	5	012940012
0,8x4x150	246	13,40	5	012940015
1x5x125	234	12,90	5	012940018
1,2x6,5x150	282	15,20	5	012940027



1294/S5 € 54,00 1 012940305
0,5x2,5x60-0,6x3x100
0,8x4x100-1x5x125
1,2x6,5x150 mm

1294L

Schraubendreher für Gewindestifte
mit Schlitz, lange Ausführung

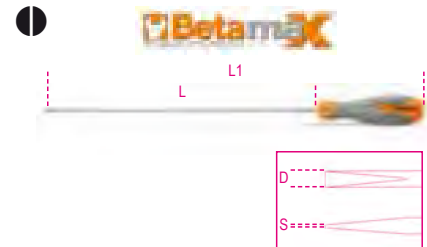

SxDxL mm	L1 mm	€	U	M
0,6x3x300	396	17,00	3	012940206
0,8x4x400	496	20,00	3	012940209
1x5x400	509	24,40	3	012940215
1,2x6,5x400	532	27,50	3	012940218

1295

Schlagschrauber



L mm € 72,00 1 012950001
130



1295/C14

Schlagschrauber
mit 14 Einsätzen und Einsatzhalter



1295/C14 € 190,00 1 012950108

	866LP	1,2x6,5 - 1,6x10 mm
	866PH	PH2 - PH3
	866PZ	PZ2 - PZ3
	866PE	5 - 6 mm
	866TX	T27 - T30 - T40 - T45 - T50 - T55
	895/6	□ 1/2 - ○ 5/16
	1295	■ 1/2

170x100x35 mm - 1,3 kg

1297TX

Stiftschlüssel mit Griff,
für Torx®-Schrauben

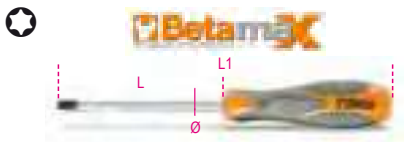

⊕	L mm	L1 mm	Ø mm	€	📦	📄
T6	50	146	3,0	14,70	5	012970006
T7	50	146	3,0	15,00	5	012970007
T8	60	156	3,0	15,10	5	012970008
T9	60	169	4,0	15,60	5	012970009
T10	80	189	4,0	16,60	5	012970010
T15	80	189	4,0	16,90	5	012970015
T20	100	209	4,5	17,20	5	012970020
T25	100	209	5,0	17,70	5	012970025
T27	115	235	6,0	18,30	5	012970027
T30	115	235	6,0	19,30	5	012970030
T40	130	262	7,0	21,40	2	012970040
T45	130	262	8,0	24,30	2	012970045



1297TX/S12 € 212,00 1 012970312
T6-T7-T8-T9-T10
T15-T20-T25-T27
T30-T40-T45



1297TX/D6 € 106,00 1 012970409
T10-T15-T20
T25-T27-T30

1297TX/L

Stiftschlüssel mit Griff,
für Torx®-Schrauben, lange Ausführung

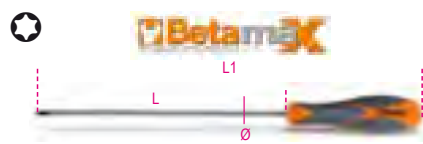

⊕	L mm	L1 mm	Ø mm	€	📦	📄
T15	210	319	4,0	18,60	2	012970115
T20	210	319	4,5	19,20	2	012970120
T25	210	319	5,0	19,80	2	012970125
T30	210	330	6,0	21,20	2	012970130
T45	210	342	8,0	23,00	2	012970145



1297TX/L-S5 € 102,00 1 012970325
TX/L15-TX/L20-TX/L25-
TX/L30-TX/L45

1298RTX

Stiftschlüssel mit Griff,
für Sicherheitsschrauben
Tamper Resistant Torx®

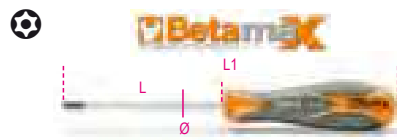

⊕	L mm	L1 mm	Ø mm	€	📦	📄
T9	60	169	4,0	17,20	5	012980009
T10	80	189	4,0	17,50	5	012980010
T15	80	189	4,0	18,60	5	012980015
T20	100	209	4,0	18,80	5	012980020
T25	100	209	4,5	19,20	5	012980025
T27	115	235	5,5	20,60	5	012980027
T30	115	235	6,0	21,40	5	012980030
T40	130	262	7,0	23,00	2	012980040



1298RTX/S8 € 156,00 1 012980308
T9-T10-T15-T20
T25-T27-T30-T40

1299PZ

Schraubendreher
für Pozidriv®- und Supadriv®-Schrauben

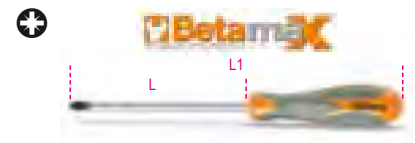

UNI/ISO 8764

PZ	L mm	L1 mm	€	📦	📄
0	60	156	11,40	5	012990000
1	80	189	13,50	5	012990003
2	100	220	18,30	5	012990006
3	150	282	26,50	2	012990009
4	200	332	37,50	2	012990012



1299PZ/S6 € 96,50 1 012990306
1299PZ PZ0-PZ1-PZ2-PZ3
1299N/PZ PZ1-PZ2

1299N/PZ

Schraubendreher
für Pozidriv®- und Supadriv®-Schrauben,
extrakurze Ausführung



UNI/ISO 8764

PZ	L mm	L1 mm	€	📦	📄
1	30	86	13,10	5	012990021
2	30	86	14,50	5	012990024



KFZ-SPEZIAL

Unsere Kfz-Spezialwerkzeuge, die von den anspruchsvollsten Professionisten verwendet werden, wurden entwickelt und ausgelegt, um die höchsten Weltstandards zu erfüllen. Sie werden kontinuierlich unter schwersten Nutzungsbedingungen getestet. Seit mehr als 50 Jahren sind wir mit Stolz Seite an Seite mit den großen Meistern, die uns dabei helfen, unsere Produkte ständig zu verbessern, und die unsere absolut hohe Qualität bestätigen.

Die Kfz-Spezialwerkzeuge finden Sie in diesen Abschnitten:

Diagnostik	von 1438 bis 1499 von 1758VT bis 1760TMC
Motor	von 955 bis 989A von 1438 bis 1499
Öl und Filter	von 1438 bis 1499 von 1877 bis 1885
Electric system	von 1438 bis 1499
Anlasser	von 1498BC/12 bis 1498/40A
Getriebe	von 1438 bis 1499
Radaufhängungen	von 1549 bis 1569CP
Bremsen	von 1438 bis 1499
Bereifung	von 955 bis 989A
Karosserie	von 1302 bis 1369 von 1763 bis 1767A
Weitere Einrichtungen	von 1875LT bis 3067
Heben	von 3029/2T bis 3067/70-13T



1302
Handfaust, runde gewölbte und keilförmige Arbeitsfläche



g 770 € 112,00 1 013020001

1303
Handfaust für Kanten



g 1350 € 84,50 1 013030001

1304
Handfaust für gebördelte Kanten



g 875 € 107,00 1 013040001

1305
Handfaust, Zehenform



g 1190 € 67,50 1 013050001

1305Z
Handfaust, Zehenform, kariert



g 1065 € 80,00 1 013050002

1306
Handfaust, Absatzform



g 1040 € 63,00 1 013060001

1307
Handfaust für Konturen

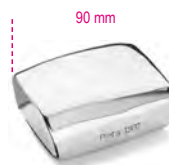

g 1100 € 125,00 1 013070001

1308
Handfaust, oval



g 1100 € 116,00 1 013080001

1310
Handfaust, Schienenform



g 1225 € 71,50 1 013100001

1312
Handfaust, Ambossform



g 1220 € 154,00 1 013120001

1314
Handfaust, runde gewölbte
und runde flache Arbeitsfläche



g 760 € 68,00 1 013140001

1326
Löffeleisen



g 560 € 61,00 1 013260001

1327
Löffeleisen, schwere Ausführung



g 1075 € 85,00 1 013270001

1328
Löffeleisen, leichte Ausführung



g 935 € 77,00 1 013280001

1329
Hebeleisen, breit, um 90° gebogen



g 1800 € 236,00 1 013290001

1330
Hebeleisen, breit



g 2125 € 251,00 1 013300001

1331
Biegeisen mit Lederaufsatz



g 1100 € 140,00 1 013310001

1335BM
Bleischlagwerkzeug,
Griff aus Kunststoff



g 500 € 41,00 2 013350010

1337/S5
Karoseriespachtelsatz, 5teilig, aus Edelstahl

japanischer Typ
(25-50-75-100-125 mm)



L mm 25-50-75-100-125 € 15,70 1 013370015

1338A - 1338B
Karosseriefeilen
mit flexiblen Fräsenfeilenblatt



	mm/1"	L mm	€		
1338A	9	360	116,00	2	013380001
1338B	12	360	122,00	2	013380002

1338
Karosseriefeile für Art. 1338R



1338 € 62,50 2 013380003

1338R9 - 1338R12
Ersatzfeilenblätter für Art. 1338A-B



	mm/1"	€		
1338R9	9	52,50	2	013380004
1338R12	12	58,50	2	013380005

1342
Flachmeißel, extradünn



L mm 235 € 36,50 5 013420001

1342PM
Flachmeißel, extradünn, mit Handschutz

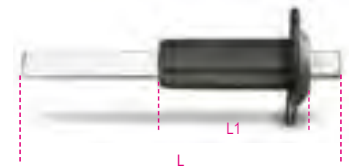

L mm 235 L1 mm 118 € 51,50 2 013420002

1342PMR
Ersatzhandschutz für Art. 1342



1342PMR € 15,00 1 013420003

1343
Trennmeißel



L mm 200 € 38,00 5 013430001

1344

Fühlerlehrenpaar für Karosseriebauer mit 10 Klingen und Befestigungssaugnäpf

Geeignet für:

- Positionierung Heckscheiben
- Positionsbeibehaltung während dem Einbau



1344 € 44,00 1 013440010

1344A/VW

Werkzeug zum Entfernen des Hakens zur Befestigung der Türgriffe Volkswagen



L mm 260 € 20,00 1 013440100

1345

Planierhammer, runder gewölbter Kopf und Pinne, Stiel aus Holz



1345 € 53,50 2 013450010

1351

Planierhammer, runder flacher Kopf und kugelförmige Pinne, Stiel aus Holz



1351 € 53,50 2 013510010

1353

Planierhammer, runder flacher Kopf und spitze Pinne, Stiel aus Holz



1353 € 54,50 2 013530010

1357Z/45

Schlichthämmer, flache Köpfe, rund kariert und eckig glatt, Stiel aus Holz



1357Z/45 € 87,50 2 013570045

1359T

Planierhammer, runder flacher Kopf und horizontale Pinne, Stiel aus Holz



1359 T € 53,50 2 013590010

1360G

Rückschlagfreier Hammer aus weichem Gummi, für die Montage von Dichtungen und empfindlichen Komponenten
Aufgrund der extremen Weichheit der Schlagfläche werden keine Werkteile beschädigt, da der Stoß durch Verbiegen absorbiert wird



L mm 280 Ø mm 72 € 88,00 1 013600000

1360/K6

Aluminiumhammer mit flachem Rundkopf, untereinander auswechselbare Kunststoffstifte und Körner

- Geliefert mit:
- 4 Kunststoffstiften
 - 1 Körner verstellbar in 2 unterschiedliche Längen am Hammer anbringbar



L mm 320 Ø mm 34 € 102,00 1 013600006

1360/KP3

Hämmer mit Kugelkopf und spitzem Stift plus Punze aus Kunststoff

Inhalt des Kit:

- 1 Hammer 210 g mit Kopf Ø 30 mm
- 1 Hammer 290 g mit Kopf Ø 40 mm
- 1 Punze 75 g mit Spitze 5 mm



1360/KP3 € 97,50 1 013600503

1361/C12

Teflon®-Spitzensatz für Karosserie



1361/C12 € 154,00 1 013610012

275x160x57 mm

1361/K9

Hebelsatz, 8-teilig, für Beulenzieher

Kitinhalte:

- Hebel mit rundem Kugelkopf, Ø 31 mm, Länge 110 cm
- Hebel mit Spitze, Länge 62 cm
- Hebel mit Walschwanzspitze, Länge 112 cm
- Hebel mit Hakenspitze, Länge 27 cm
- Hebel mit rundem, flachem Kopf, Länge 50 cm
- Hebel mit rundem Kugelkopf, Ø 19 mm, Länge 52 cm
- Hebel mit Walschwanzkopf, Länge 27 cm
- Hebel mit abgerundetem Walschwanzkopf, Länge 28 cm
- Stofftasche mit Griffen



1361/K9 € 361,00 1 013610030

1362B

Dellenreflektor aus Gewebe, rund

- Oberfläche völlig mit kratzfestem Material beschichtet
- In Aufbewahrungstasche



1362B	∅ mm	€	1	013620011
	755	92,50		

1364SE

Karosseriehalter, erweiterbar

Technische Eigenschaften:

- 4 Lenkrollen, davon 2 gebremst
- Pantograph erweiterbar bis zu 1400 mm
- Höhenverstellbar bis zu 1315 mm
- Stellungsverriegelung
- Abstellfläche mit abnehmbarem Gummiüberzug



	L mm	H mm	P mm	€	1	013640001
	215÷1400	780÷1315	890	477,00		

1364SV

Karosseriehalter mit Zentralablage

Technische Eigenschaften:

- Abstellfläche mit Polyethylenüberzug
- Abmessungen Ablage: 340x845x40 mm
- Zusammenklappbar



	H mm	€	1	013640002
	1000	271,00		

1364SCP

Karosseriehalter, verstellbar

Besonders geeignet für Motorhauben, Kotflügel und Türen
Ausgestattet mit 4 Rollen, davon 2 lenkbar und gebremst
Um 180° schwenkbar

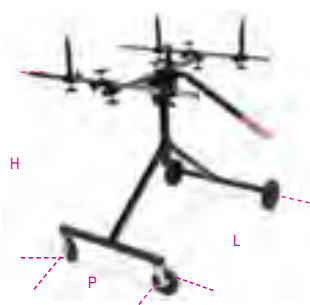

	H mm	L mm	P mm	€	1	013640003
	1300	1100	680	435,00		

1364SP

Karosseriehalter mit Saugnäpfen

Besonders geeignet für die Anwendung mit Autoscheiben
Ausgestattet mit 4 Saugnäpfen, ∅ 95 mm
Erweiterung verstellbar durch Kette
Rohre mit Polyethylenüberzug



	H mm	L mm	€	1	013640004
	1250	950	217,00		

1364SR

Abdeckpapierrollenhalter auf Rädern

Technische Merkmale:

- 2 Räder zur Fortbewegung
- 3 Rollenstangen mit integrierter Papierschnide Klinge
- integrierter Papierstreifenhalter
- Max. Rollengröße: 350 - 650 -1050 mm



	L mm	P mm	H mm	H1 mm	€	1	013640005
	1530	520	1080	960	278,00		

1365/K13

Hydraulikpumpe 10 t und Zubehörkit für Karosserie im Trolley

Im Kit enthalten:

- Hydraulikpumpe 10 Tonnen mit 1,5 m Schlauch, Anschluss 1/2"
- Kolben
- Kotflügel Sprezzange Kapazität 500 kg
- Stützplatte 150x90 mm
- L-Basis 50x50 mm
- Durchschläger mit 4 Punkten
- Gerändelte Stempelplatte ∅ 50 mm
- Keilaufsatz 43 mm
- Verlängerung 170 mm
- Verlängerung 300 mm
- Verlängerung 400 mm
- Verlängerung 530 mm
- Gummikopf
- Adapter für Zubehörmontage



1365/K13	€	1	013650013
	940,00		

900x420x180 mm

1365P10

Hydraulikpumpe

1,5 m Schlauch, Anschluss 1/2"



1365P10	€	1	013650110
	419,00		

1366A

Dellenfernerwerkzeug mit 19 Zugknöpfen aus Kunststoff

mit Heißkleber zu verwenden für lackierte Oberflächen.

Ideal für:

- Hageldellen
- durch Autotüren verursachte Dellen
- kleine Dellen allgemein



1366A	€	1	013660200
	106,00		

1366B

Schlaggewicht für Zugknöpfe zum Ziehen von Dellen, aus Kunststoff

Schlaggewicht: 500 g



L
mm 440 € 59,00 1 013660250

1366KF

Kit 19 Zugknöpfe aus Kunststoff für Artikel 1366A



1366/KF € 38,50 1 013660205

1366/K5

Pneumatischer Beulenzieher mit Schlaggewicht 1,1 kg

Im Kit enthalten:

- 1 Saugnapf Ø 75 mm
- 1 Saugnapf Ø 100 mm
- 1 Saugnapf Ø 125 mm
- 1 Haken



1366/K5 € 277,00 1 013660010

610x240x90 mm



1366SH

Multifunktionspotter für Karosseriereparaturen

- Mikroprozessor zur Verwaltung der Schweißparameter
- Schweißzyklusstart durch Kontakt und manuell
- Einstellung der automatischen Punktschweißzeit möglich
- Pistole mit Schnellkupplung und 2,2 m Erdungskabel

Zubehörsatz mit:

- Ausbeulhammer
- Kopf für 3-Punkt-Ausbeulscheibe
- 10 3-Punkt-Ausbeulscheiben
- Kohleelektrode
- Elektrode zum Ausbeulen



Technische Daten:
 Stromversorgung: 230 V
 Leistung 50 %: 2,5 KVA
 Spitzenleistung: 13 KVA
 Amp. Out.: 2850 (2%) A
 Max. Amp Out: 3200 A

1366SH € 2.370,00 1 013660400

1366SH/C

Laufwagen für Spotter Art. 1366SH



1366SH/C € 463,00 1 013660410

1366SL

Zughebel für Wiederherstellung von Blech

Mehrfachhakenkopf für Verwendung mit Welldraht



L
mm 700 € 280,00 1 013660002

1366ST

Zugquerträger für Wiederherstellung von Blech

Mehrfachhakenkopf für Verwendung mit Welldraht



L
mm 850 € 706,00 1 013660003

1366S/R1

Spindel für 3-Punkt-Scheiben



1366S/R1 € 28,00 1 013660501

1366S/R2

3-Punkt-Scheibe zum Blechrichten



1366S/R2 € 28,00 1 013660502

Die angegebenen Preise beziehen sich auf 20 Stück

1366S/R3

Elektrode für Scheiben Ø 8x16x1,5 mm



1366S/R3 € 33,50 1 013660503

1366S/R4

Haken für Unterlegscheiben Ø 8x16x1,5 mm



1366S/R4 € 28,50 1 013660504

1366S/R5

Scheiben Ø 8x16x1,5mm



1366S/R5 € 16,00 1 013660505

Die angegebenen Preise beziehen sich auf 100 Stück

1366S/R6

Elektrode für Schrauben M5-M6



1366S/R6 € 32,50 1 013660506

1366S/R7

100 selbstschneidende Stifte 5x18 mm



1366S/R7 € 28,00 1 013660507

1366S/R8

100 selbstschneidende Stifte 5x25 mm



1366S/R8 € 38,00 1 013660508

1366S/R9

100 Gewindestifte M5 x 18 mm



1366S/R9 € 26,00 1 013660509

1366S/R10

10 gelochte Unterlegscheiben



1366S/R10 € 17,70 1 013660510

1366S/R11

Elektrode für gelochte Unterlegscheiben



1366S/R11 € 90,00 1 013660511

1366S/R12

10 gelochte Unterlegscheiben 90°



1366S/R12 € 35,00 1 013660512

1366S/R13

Kohle-Elektrode
Blecherhitzung



1366S/R13 € 64,50 1 013660513

Die angegebenen Preise beziehen sich auf 5 Stück

1366S/R14

Elektrode für Drahtpunktsschweißen



1366S/R14 € 32,00 1 013660514

1366S/R21

Welldraht für Verwendung
Zughebel und Zugquerträger



1366S/R21 € 21,90 1 013660551

Die angegebenen Preise beziehen sich auf 10 Stck.

1366S/R22

Magnethalterung
für Welldraht



1366S/R22 € 75,50 1 013660552

1366S/R24

M4-Ziehlkopf



1366S/R24 € 87,00 1 013660554

Die angegebenen Preise beziehen sich auf 5 Stck.

1366S/R25

M5-Zielkopf



1366S/R25 € 87,00 1 013660555

Die angegebenen Preise beziehen sich auf 5 Stck.

1366S/R26

M6-Zielkopf



1366S/R26 € 87,00 1 013660556

Die angegebenen Preise beziehen sich auf 5 Stck.

1367/S4

Locheisatz für
Installation von Parksensoren

Maße:
23 - 24 - 27 - 28

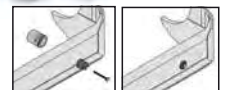

1367/S4 € 255,00 1 013670104



1367/K4

Satz mit 4 Radkastenklammern



Maximale Backenöffnung: 6,5 mm

L	H	S	€	U	M
mm	mm	mm			
1367/K4	62	40+58	15,7	78,00	1 013670010

1367/K10

Kit Locheisen für Installation von Parkensoren

Kitinhalt:

• Maße: 17 - 18 - 18,2 - 19 - 20 - 22,5 - 24 - 26 - 26,7 - 32 mm



Ø 12 mm

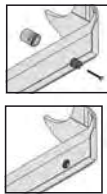

1367/K10	€	U	M
	215,00	1	013670200

190x130x58 mm

1368

Kunststoffreparatur-Set

• Ermöglicht schnelle Reparatur von gerissenen und gebrochenen Kunststoffteilen

Stromversorgung: 220+240 V mit Schuko-Steckerbuchse
 Heißluftpistole, Kabellänge 3,5 m
 Stromversorgung, Kabellänge 1,35 m
 2 Leistungsstufen 35-75 W
 Heißluftpistole mit Anschlussklemmen aus Messing, 2
 Klemmen-Einsteckwinkel, 0°-90°
 Eingangsschutz: Thermischer Schutzschalter
 Ausgangsschutz: 10 A Sicherung
 Pistolenhalterung aus Metall

CE



1368	€	U	M
	502,00	1	013680001

1368G/K400

Sortiment 400 Klammern für Art. 1368



1368G/K400	€	U	M
	86,00	1	013680140

1368G/OD

Gerade Wellklammern für Art. 1368



1368G/OD	€	U	M
	21,50	1	013680100

Die angegebenen Preise beziehen sich auf 100 Stück

1368G/SD

Gerade Spiralklammern für Art. 1368



1368G/SD	€	U	M
	21,50	1	013680110

Die angegebenen Preise beziehen sich auf 100 Stück

1368G/CV

Klammern für Konkavwinkel für Art. 1368



1368G/CV	€	U	M
	21,50	1	013680120

Die angegebenen Preise beziehen sich auf 100 Stück

1368G/C2U

Klammern für Konkavwinkel für Art. 1368



1368G/C2U	€	U	M
	21,50	1	013680130

Die angegebenen Preise beziehen sich auf 100 Stück

GRIFFE DER HAMMER

Griffe aus **Hickory** Holz

Hickory ist ein Holz mit optimalen Qualitäten, die sich perfekt für den Griff eines Hammers eignen. Seine langfaserige Struktur absorbiert die Vibrationen und verleiht dem Griff eine hohe Bruchfestigkeit. Für den denkbaren Fall eines Bruchs einiger Fasern ist das Risiko, dass sich der Kopf plötzlich löst, jedoch sehr gering.

Die Holzgriffe können ausgetauscht werden, falls sie verschlissen sind. Da Holz ein natürliches Material ist, muss es seine Feuchtigkeit bewahren. Daher wird empfohlen, den Hammer nicht an einem zu trockenen Ort aufzubewahren.

Griffe aus **Glasfaser**

Die Griffe mit Glasfaserkern sind widerstandsfähig und sicher; sie reduzieren aufs Geringste das Risiko von Brüchen und Verletzungen. Sie sind beständig gegen Witterungseinflüsse und gegen die meisten chemischen Stoffe.



• **Unzerstörbarer Glasfaserkern**

• **Ergonomische Struktur aus Polypropylen**

• **Rutschfeste Beschichtung aus komfortablem Elastomer**

1369/C11

Werkzeugsortiment, 11teilig



1369/C11 € 1.001,00 1 013690033



1303
1305
1306
1302
1310
1314
1327
1338A
1353
1357Z/45
1390

470x340x70 mm - 15,2 kg

1370

Schlosserhammer, deutsches Modell,
Stiel aus Holz



HICKORY

UNI 7778 DIN 1041

g	A mm	L mm	L1 mm	€		
100	15	260	82	14,20	5	013700051
200	19	280	95	16,00	5	013700052
300	23	300	105	18,30	5	013700053
400	25	310	112	20,70	5	013700054
500	27	320	118	22,30	5	013700055
600	30	330	122	26,00	5	013700056
800	33	350	130	28,50	4	013700058
1000	36	360	135	34,50	4	013700060
1500	42	380	145	39,50	2	013700065
2000	47	400	155	47,00	1	013700070

1370/MR...

Ersatzstiele für Art. 1370



	€		
1370MR 100 1370/100	6,60	4	013700081
1370MR 200 1370/200	7,10	4	013700082
1370MR 300 1370/300	7,80	4	013700083
1370MR 400 1370/400	8,30	4	013700084
1370MR 500 1370/500	9,20	4	013700085
1370MR 600 1370/600	10,10	4	013700086
1370MR 800 1370/800	10,60	4	013700088
1370MR 1000 1370/1000	11,30	4	013700090
1370MR 1500 1370/1500	12,80	4	013700095
1370MR 2000 1370/2000	14,20	4	013700100

1370T

Schlosserhammer, deutsches Modell,
Stiel aus Fasern



g	A mm	L mm	L1 mm	€		
200	19	280	95	24,60	5	013700620
300	23	300	105	27,00	5	013700630
500	27	320	118	30,00	5	013700650
800	33	350	130	31,50	4	013700680
1000	36	360	135	39,50	4	013700700
1500	42	365	145	46,50	2	013700750

1370F

Schlosserhammer,
französisches Modell,
Stiel aus Holz



NF E 71.014

A mm	L mm	L1 mm	€		
24	260	77	24,70	2	013700424
26	260	80	26,50	2	013700426
28	280	86	28,00	2	013700428
30	280	92	28,50	2	013700430
32	300	100	30,50	2	013700432
36	300	104	39,50	2	013700436
40	330	110	44,00	2	013700440
42	330	116	46,50	2	013700442
50	380	138	48,50	2	013700450
60	380	160	60,00	2	013700460

1370F/MR...

Ersatzstiele für Art. 1370F



	€		
1370F/MR 24 1370F/24-26	6,40	2	013700474
1370F/MR 28 1370F/28-30	6,90	2	013700478
1370F/MR 32 1370F/32-36	8,00	2	013700482
1370F/MR 40 1370F/40-42	10,00	2	013700490
1370F/MR 50 1370F/50	11,30	2	013700495
1370F/MR 60 1370F/60	13,50	2	013700496

1370FT

Schlosserhammer, französisches Modell, Stiel
aus Fasern



A mm	L mm	L1 mm	€			
28	280	86	530	40,00	1	013700528
30	280	92	625	42,00	1	013700530
32	300	100	750	44,00	1	013700532
36	300	104	930	52,00	1	013700536
40	330	110	1150	55,00	1	013700540
42	330	116	1250	56,50	1	013700542
50	380	138	2100	63,50	1	013700550
60	380	160	2750	68,50	1	013700560

1374F

Schreinerhammer,
französisches Modell,
Stiel aus Holz



NF E 71.012

A mm	L mm	L1 mm	€			
16	250	80	180	19,80	2	013740416
20	270	86	250	22,00	2	013740420
22	290	92	335	22,70	2	013740422
26	290	103	425	26,00	2	013740426
28	310	108	510	27,00	2	013740428
30	310	117	580	28,50	2	013740430

1374F/MR...

Ersatzstiele für Art. 1374F



	€		
1374F/MR 16 1374F/16	5,90	2	013740456
1374F/MR 20 1374F/20	6,00	2	013740460
1374F/MR 22 1374F/22-26	6,10	2	013740462
1374F/MR 28 1374F/28	6,90	2	013740468
1374F/MR 30 1374F/30	7,40	2	013740470



1375

Klauenhammer, Stiel aus Holz



g	L1 mm	Ø mm	L mm	€	U	IT
300	95	25	300	22,70	3	013750000

1375/MR

Ersatzstiele für Art. 1375



g	€	U	IT
1375/MR	10,40	2	013750003

1375A

Klauenhämmer, Stiel aus Kunststoff und Glasfaser



oz	g	L mm	L1 mm	€	U	IT
16	450	330	130	33,00	3	013750016
20	570	330	130	34,50	3	013750020

1375B

Klauenhämmer, Stiel aus Stahl



oz	g	L mm	L1 mm	€	U	IT
16	450	330	130	30,00	3	013750026
20	570	330	130	30,50	3	013750030

1376X

Klauenhämmer, eckiger Kopf, mit Nagelhalter und Magnet, für Bauschreiner, Stiel aus Holz



g	A mm	L1 mm	L mm	€	U	IT
250	20	125	450	21,70	3	013760125
300	25	130	450	22,90	3	013760130
400	27	132	450	25,00	3	013760140

1376X/MR

Ersatzstiel für Art. 1376X



g	€	U	IT
1376X/MR	12,30	2	013760161

1376XT

Klauenhämmer, eckiger Kopf, mit Nagelhalter und Magnet, für Bauschreiner, Stiel aus Kunststoff



g	A mm	L1 mm	L mm	€	U	IT
250	20	125	500	26,00	3	013760525
300	25	130	500	28,00	3	013760530
400	27	132	500	30,00	3	013760540

1376XT/MR

Ersatzstiel für Art. 1376XT



g	€	U	IT
1376MR/XT	14,10	2	013760585

1377

Hämmer für Blechbearbeitung, amerikanisches Modell mit rundem Kopf und kugelförmiger Pinne, Stiel aus Holz



HICKORY

g	L mm	L1 mm	€	U	IT
340	330	95	33,00	2	013770134
450	350	102	34,50	2	013770145
570	350	110	39,50	2	013770157
680	360	116	41,50	2	013770168
900	380	120	43,50	2	013770190

1377/MR...

Ersatzstiele für Art. 1377



g	€	U	IT
1377MR 340 1377/340	7,30	2	013770234
1377MR 450 1377/450	8,30	2	013770245
1377MR 570 1377/570	9,30	2	013770257
1377MR 680 1377/680	9,40	2	013770268
1377MR 900 1377/900	11,70	2	013770290

1377T

Hämmer für Blechbearbeitung, amerikanisches Modell, mit rundem Kopf und kugelförmiger Pinne, Stiel aus Faser



g	L mm	L1 mm	€	U	IT
340	330	95	30,50	2	013770534
450	350	102	37,00	2	013770545
570	350	110	40,00	2	013770557
680	360	116	43,50	2	013770568
900	380	120	49,00	2	013770590

1378

Hämmer für Blechbearbeitung, amerikanisches Modell mit rundem Kopf und symmetrischer Pinne, Stiel aus Holz



HICKORY

g	L mm	L1 mm	Ø mm	€	U	IT
340	330	100	27	30,50	2	013780134
570	350	115	32	39,50	2	013780157

1378/MR...

Ersatzstiele für Art. 1378



g	€	U	IT
1378MR 340 1378/340	6,90	2	013780234
1378MR 570 1378/570	9,60	2	013780257

1379F

Elektrikerhämmer, französisches Modell, Stiel aus Holz



HICKORY

NF E 71.011

A mm	L mm	L1 mm	€	U	IT
16	250	126	19,70	2	013790416
18	250	135	21,50	2	013790418
20	260	142	22,70	2	013790420

1379F/MR...

Ersatzstiele für Art. 1379F



	€	Hand	Icon
1379F/MR 16 1379F/16-18	6,20	2	013790426
1379F/MR 20 1379F/20	6,90	2	013790430

1380

Fäustel, Stiel aus Holz



HICKORY

UNI 7777 DIN 6475

g	A mm	L mm	L1 mm	€	Hand	Icon
800	38	260	90	25,00	2	013800208
1000	40	260	95	27,50	2	013800210
1250	43	260	100	28,00	2	013800212
1500	45	280	110	33,00	2	013800215
2000	50	300	120	43,00	2	013800220

1380/MR...

Ersatzstiele für Art. 1380



	€	Hand	Icon
1380MR 800 1380/800-1000-1250	8,10	2	013800238
1380MR 1500 1380/1500	8,60	2	013800245
1380MR 2000 1380/2000	9,90	2	013800250

1380S

Fäustel mit Stielschutzhülle aus Kunststoff, Stiel aus Holz



g	A mm	L mm	L1 mm	€	Hand	Icon
800	36	260	90	28,00	2	013800400
1000	39	260	95	30,50	2	013800405
1250	43	260	100	33,00	2	013800410
1500	45	260	110	37,00	2	013800415

1380S/MR...

Ersatzstiele für Art. 1380S



	€	Hand	Icon
1380S/MR 800 1380S/800-1000-1250	8,30	2	013800417
1380S/MR 1500 1380S/1500	9,20	2	013800419

1380T

Fäustel, Stiel aus Fasern



g	A mm	L mm	L1 mm	€	Hand	Icon
800	35	260	85	38,50	2	013800308
1000	40	260	100	39,00	2	013800310
1250	42	260	110	41,50	2	013800312
1500	45	260	120	44,50	2	013800315
2000	49	295	120	53,50	1	013800320

1381

Vorschlaghammer, Stiel aus Hickory

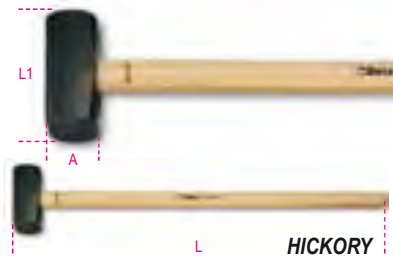

HICKORY

g	A mm	L mm	L1 mm	€	Hand	Icon
3000	55	800	142	103,00	1	013810030
4000	60	900	152	115,00	1	013810040
5000	70	900	162	131,00	1	013810050
8000	80	900	185	225,00	1	013810080

* = Stiel aus Eschenholz

1381/MR...

Ersatzstiele für Art. 1381



	€	Hand	Icon
1381MR 3-4 1381/3000-4000	51,00	2	013810730
1381MR 5 1381/5000	53,00	2	013810750
1381MR 8 1381/8000	53,00	2	013810780

1381T

Vorschlaghammer, Stiel aus Kunststoff



g	A mm	L mm	L1 mm	€	Hand	Icon
3000	55	900	142	112,00	1	013810330
4000	60	900	152	123,00	1	013810340
5000	70	900	162	140,00	1	013810350
8000	82	920	180	258,00	1	013810380

1385

Hämmer mit Kupferkopf, Stiel aus Holz



g	A mm	L mm	L1 mm	€	Hand	Icon
400	26	260	75	39,00	2	013850404
600	32	270	80	56,50	2	013850406
800	34	280	90	74,00	2	013850408
1000	37	280	100	92,00	2	013850410
1500	43	280	110	136,00	2	013850415
2000	48	300	120	183,00	1	013850420

1385/MR

Ersatzstiele für Art. 1385



	€	Hand	Icon
1385MR 400 1385 400	11,30	2	013850464
1385MR 600 1385 600	11,70	2	013850466
1385MR 800 1385 800	11,90	2	013850468
1385MR 1000 1385 1000	12,80	2	013850470
1385MR 1500 1385 1500	14,20	1	013850475
1385MR 2000 1385 2000	14,60	1	013850480

1390

Hämmer mit auswechselbaren Kunststoffaufsätzen, Stiel aus Holz



UNI 7784

Ø mm	L mm	L1 mm	€	Hand	Icon
22	260	70	22,30	5	013900022
28	280	85	27,50	5	013900028
35	310	95	37,50	5	013900035
45	320	107	59,50	4	013900045
60	380	128	102,00	2	013900060

1390/MR...

Ersatzstiele für Art. 1390



	€	Hand	Icon
1390MR 22 1390/22	5,60	2	013900222
1390MR 28 1390/28	6,40	2	013900228
1390MR 35 1390/35	7,50	2	013900235
1390MR 45 1390/45	9,20	2	013900245
1390MR 60 1390/60	11,30	2	013900260

1390R

Ersatzaufsätze für Art. 1390



Ø mm	€	U	M
22	3,60	4	013900122
28	5,50	4	013900128
35	7,30	4	013900135
45	12,30	4	013900145
60	21,10	4	013900160

1390N

Hämmer mit auswechselbaren
Nylonaufsätzen, Stiel aus Holz

Mittelharte Aufsätze: 75 Shore

Ölbeständig und verschleißfest

Besonders geeignet für die Bearbeitung von Blechen und Metallen



UNI 7784

Ø mm	L mm	L1 mm	€	U	M
22	260	70	22,30	3	013900522
28	280	85	27,50	3	013900528
35	310	95	37,50	3	013900535
45	320	107	59,50	2	013900545
60	380	128	102,00	2	013900560

1390NR

Ersatzaufsätze aus Nylon für Art. 1390N



Ø mm	€	U	M
22	3,60	4	013900622
28	5,50	4	013900628
35	7,30	4	013900635
45	12,30	4	013900645
60	21,10	4	013900660

1391

Rückschlagfreie Hämmer, vollständig
mit Gummi ummantelt



Ø mm	L mm	L1 mm	€	U	M
35	280	90	34,00	2	013910135
50	320	105	44,50	2	013910150
55	355	110	52,50	2	013910155
65	380	130	72,00	2	013910165

1391A

Fliesenlegerhämmer, vollständig
mit weißem Gummi ummantelt



g	Ø mm	L mm	L1 mm	€	U	M
500	45	290	100	32,50	2	013910205
1000	60	300	120	43,00	2	013910210

1392

Rückschlagfreie Hämmer
mit auswechselbaren Kunststoffaufsätzen,
Stiel aus Stahl



Ø mm	L mm	L1 mm	€	U	M
30	300	105	57,50	2	013920030
35	305	115	61,50	2	013920035
40	310	125	71,00	2	013920040
50	325	135	83,00	2	013920050
60	385	155	129,00	2	013920060

1392R

Ersatzaufsätze für Art. 1392



Ø mm	€	U	M
30	7,80	4	013920230
35	11,40	4	013920235
40	17,10	4	013920240
50	22,80	4	013920250
60	34,00	4	013920260

1393

Hämmer mit festem Gummikopf



Ø mm	L mm	L1 mm	€	U	M
50	315	90	15,10	3	013930050
60	340	110	17,10	3	013930060
70	370	130	20,60	2	013930070

KFZ-SPEZIAL

Unsere Kfz-Spezialwerkzeuge, die von den anspruchsvollsten Professionisten verwendet werden, wurden entwickelt und ausgelegt, um die höchsten Weltstandards zu erfüllen. Sie werden kontinuierlich unter schwersten Nutzungsbedingungen getestet. Seit mehr als 50 Jahren sind wir mit Stolz Seite an Seite mit den großen Meistern, die uns dabei helfen, unsere Produkte ständig zu verbessern, und die unsere absolut hohe Qualität bestätigen.

Die Kfz-Spezialwerkzeuge finden Sie in diesen Abschnitten:

Diagnostik
von 1438 bis 1499 von 1758VT bis 1760TMC
Motor
von 955 bis 989A von 1438 bis 1499
Öl und Filter
von 1438 bis 1499 von 1877 bis 1885
Electric system
von 1438 bis 1499
Anlasser
von 1498BC/12 bis 1498/40A
Getriebe
von 1438 bis 1499
Radaufhängungen
von 1549 bis 1569CP
Bremsen
von 1438 bis 1499
Bereifung
von 955 bis 989A
Karosserie
von 1302 bis 1369 von 1763 bis 1767A
Weitere Einrichtungen
von 1875LT bis 3067
Heben
von 3029/2T bis 3067/70-13T



1410/M

Hakenschlüssel zum Abziehen von Federn



Ø mm	€	Stk	Art-Nr
3,5	21,80	2	014100051

1428

Ausdreher für beschädigte Muttern mit Vierkant



Ø mm	□ mm	L mm	Ø mm	€	Stk	Art-Nr
8	3/8	36	17	21,70	2	014280008
10	3/8	36	17	21,70	2	014280010
11	3/8	36	17	21,70	2	014280011
12	3/8	36	19	21,70	2	014280012
13	3/8	36	19	21,70	2	014280013
14	3/8	36	19	21,70	2	014280014
15	1/2	38	21	22,90	2	014280015
16	1/2	38	21	22,90	2	014280016
17	1/2	38	21	22,90	2	014280017
18	1/2	38	26	22,90	2	014280018
19	1/2	38	26	22,90	2	014280019
20	1/2	38	26	25,50	2	014280020
21	1/2	38	26	25,50	2	014280021
22	1/2	38	26	28,00	2	014280022
24	1/2	38	26	28,00	2	014280024
27	1/2	38	26	29,00	2	014280027

1428L

Stehbolzenausdreher, lang, für beschädigte rechtsdrehende Muttern mit Vierkant



Ø mm	€	Stk	Art-Nr
17	55,00	1	014280217
19	56,50	1	014280219
21	61,00	1	014280221



Art-Nr	€	Stk	Art-Nr
1428L/B3	173,00	1	014280303



Art-Nr	€	Stk	Art-Nr
1428/SB11	264,00	1	014280111
8-10-11-12-13-14 15-16-17-18-19 mm			
1428/SB5	147,00	1	014280115
20-21-22-24-27 mm			

1429

Ausdreher für beschädigte Schrauben und Bolzen mit Vierkant



mm	□	L mm	€	Stk	Art-Nr
2	3/8	60	14,30	3	014290002
3	3/8	60	14,30	3	014290003
4	3/8	60	14,30	3	014290004
5	3/8	60	15,10	2	014290005
6	3/8	60	15,10	2	014290006
8	1/2	70	16,50	2	014290008
10	1/2	70	16,80	2	014290010



Art-Nr	€	Stk	Art-Nr
1429/SB7	120,00	1	014290107
2-3-4-5-6-8-10 mm			

1430/...

Schraubenausdreher aus legiertem Stahl

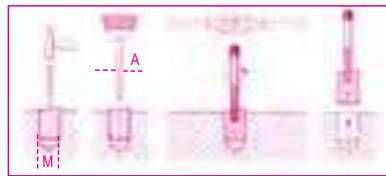

Art-Nr	M	A mm	€	Stk	Art-Nr
1430/1	3+6	2,5	4,20	10	014300006
1430/2	6+8	3,0	4,60	10	014300008
1430/3	8+11	4,5	5,50	10	014300011
1430/4	11+14	6,0	7,10	10	014300014
1430/5	14+18	8,0	8,00	10	014300018
1430/6	18+24	11,0	15,70	5	014300024
1430/7	24+33	14,0	23,50	5	014300033
1430/8	33+50	21,0	30,50	5	014300050



Art-Nr	€	Stk	Art-Nr
1430/S5	30,00	1	014300105
1430/1-1430/2-1430/3 1430/4-1430/5			
1430/S6	43,50	1	014300106
1430/1-1430/2-1430/3 1430/4-1430/5-1430/6			
1430/S8	96,50	1	014300108
1430/1-1430/2-1430/3 1430/4-1430/5-1430/6 1430/7-1430/8			

1431/...

Schraubenausdreher und Abzieher von gebrochenen Schaftschrauben

Für das Entfernen von Schrauben und Gewindebolzen, die keine Möglichkeit zum Griff bieten, Schlageinsatz

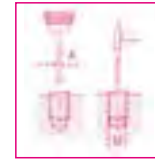

Art-Nr	M	A	L	□	€	Stk	Art-Nr
1431/3	3+6	2,5	59	5	7,30	10	014310051
1431/5	6+8	5,0	68	5	7,30	10	014310052
1431/6	8+11	6,0	72	6	8,60	10	014310053
1431/8	11+14	8,0	77	8	9,40	10	014310054
1431/9	14+18	9,0	82	9	10,10	10	014310055

1431/C5

Schraubenausdreher und Abzieher von gebrochenen Schaftschrauben

Schlageinsatz

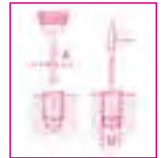

Art-Nr	M mm	A mm	€	Stk	Art-Nr
1431/C5	3+18	2,5+9	43,00	1	014310005

1433

Stehbolzenausdreher mit Walzen



Art-Nr	M mm	Ø mm	L mm	● mm	□	€	Stk	Art-Nr
5	5	21	60	19	3/8	16,00	2	014330005
6	6	24	60	21	1/2	16,00	2	014330006
7	7	24	60	21	1/2	16,00	2	014330007
8	8	24	60	21	1/2	16,00	2	014330008
9	9	28	70	21	1/2	19,00	2	014330009
10	10	28	70	21	1/2	19,00	2	014330010
10,5	10,5	28	70	21	1/2	19,00	2	014330021
11	11	28	70	21	1/2	19,00	2	014330011
12	12	28	70	21	1/2	19,00	2	014330012
14	14	36	72	24	-	30,50	2	014330014
16	16	36	72	24	-	30,50	2	014330016

1433/C11

Stehbolzenausdreher mit Walzen, mit Innenvierkantantrieb 1/2"

38"
12"
●



1433/C11 € 310,00 1 014330311
M5 - M6 - M7 - M8 - M9 - M10 - M10,5
M11 - M12 - M14 - M16
340x135x56 mm - 3,0 kg

1435

Stehbolzenausdreher mit Rändelspannscheibe



∅ mm € 117,00 1 014350001
4÷20

1435R

Ersatz-Rändelspannscheibe für Art. 1435



1435R € 36,50 1 014350010

1435/1

Stehbolzenausdreher mit Rändelspannscheibe



∅ mm € 145,00 1 014350002
19÷26

1435/1R

Ersatz-Rändelspannscheibe für Art. 1435/1



1435/1R € 37,50 1 014350011

1437/C12

Werkzeugsortiment, 12teilig, für Airbagausbau



1437/C12 € 116,00 1 014370001
260x160x55 mm - 1,0 kg

1438

Kupplungszentriergerät mit 3 spreizbaren Einsätzen



1438 € 62,50 1 014380001

1438R

Spreizbare Einsätze für Art. 1438



∅ mm € 5 014380101
14÷18 4,40 5 014380102
18÷21 4,40 5 014380103
22÷25 4,40 5 014380103

1438EVO

Universalsatz für Kupplungszentrierung

Komponenten vollständig aus Metall



1438EVO € 278,00 1 014380011
290x200x60 mm - 2 kg

1438DSG

Hebel für Verriegelung/Entriegelung Doppelkupplungsgetriebe DSG der Gruppe VAG



1438DSG € 38,00 1 014380200

1438K/DSG-2

Satz zum Ausrichten von 6- und 7-Gang-DSG-Kupplungen

Zur Verwendung mit 6-Gang-DSG- und manuellen, 7-Gang-DSG (1. und 2. Serie) und S-Tronic-Getrieben.



1438K/DSG-2 € 700,00 1 014380260
350x370x117 mm - 10 kg

1438K/PWR

Satz zur Entfernung und Installation der Doppelkupplung des PowerShift-Getriebes



1438K/PWR € 479,00 1 014380270
440x400x85 mm - 10 kg

1438DCT/S

Satz zum Ausrichten von
Zweischeibentrockenkupplungen, Fahrzeuge
Ford

Zum Ausrichten der Kupplung,
z.B. nach dem Auswechseln der Dichtringe am Getriebe



1438DCT/S	€ 364,00	1	014380305
☞ 440x400x85 mm - 8 kg			

1439/K7

Winkelschraubendreher, um 90° geneigt,
lange Ausführung, mit Klängen, im Koffer



Kofferausstattung:
- Winkelschraubendreher
- 1 Schlitzschraubenkopf
- 1 Bitskopf 1/4"
- 1 Spezialklängenkopf
- 7 Spezialklängen

1439K7	€ 233,00	1	014390101
☞ 500x120x60 mm 825 g			

1440/...

Kolbenring-Spannbänder



	Ø mm	L mm	€		
1440/0	40÷75	50	34,50	1	014400000
1440/1	57÷125	80	45,00	1	014400010
1440/1A	57÷125	100	51,50	1	014400011
1440/2	90÷175	80	55,00	1	014400020
1440/2A	90÷175	100	57,50	1	014400021
1440/3	90÷175	165	83,50	1	014400030

1445/1 - 1445/2

Kolbenringzangen



	Ø mm	€		
1445/1	50÷100	47,50	1	014450001
1445/2	90÷150	61,00	1	014450002

1452K

Ventilfederspanner mit drei Flanschen

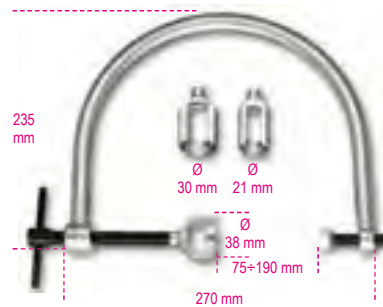

1452K	€ 181,00	1	014520100
-------	----------	---	-----------

1452PN/K

Druckluftwerkzeug für Motorventilfedern

Schubdruck 1400 N



Ø mm	L mm	L1 mm	€		
16-19-23	230	185	385,00	1	014520110
25-30-42					

1454P

Schaber zum Entfernen von Rückständen
von Dichtungen und Dichtungsmasse

Besonders geeignet zum Reinigen
von zu verbindenden Flächen und Köpfen



L mm	L1 mm	±s mm	€		
210	32	3,3	50,50	1	014540010

1455SVP

Pressluft-Ventilschleifer

• Betriebsdruck: 6 bar.



1455SVP	€ 439,00	1	014550001
---------	----------	---	-----------

1455SVP/R...

Gummisaugnapf-Ersatzteile
für Art. 1455SVP



	€		
1455SVP/R1	7,90	5	014550501
1455SVP/R2	7,90	5	014550502
1455SVP/R3	7,90	5	014550503

1457/B4

Werkzeugsatz zum Abtrennen/zur
Entriegelung von
Rilsan-Steckverbindern

Enthaltene Maße:
• 6x8
• 10x12
• 15x16
• 18x12



1457/B4	€ 58,50	1	014570024
---------	---------	---	-----------

1458

Zange für Sprengringe
mit Außenspannung



DIN 5417

Ø mm	€		
30÷100	86,00	2	014580001

1460F

Ventildichtringzange



1460F € 73,50 1 014600010

1462CF/C6

Offener Zwölfkantschlüsselsatz für Kraftstoffinjektorenanschlüsse, 6-teilig

Maße:
12-14-16-17-18-19 mm



1462CF/C6 € 115,00 1 014620006

260x145x60 mm - 1,2 kg

1462CF

Offene Zwölfkantschlüssel für Kraftstoffinjektorenanschlüsse



mm	€	1	014620012
12	18,30	1	014620012
14	18,50	1	014620014
16	18,80	1	014620016
17	19,30	1	014620017
19	20,20	1	014620019
18	19,70	1	014620018

1462CF-SN/C6

Offener Gelenk-Sechskantschlüsselsatz für Kraftstoffinjektorenanschlüsse, 6-teilig

Maße:
12-14-16-17-18-19



1462CF-SN/C6 € 166,00 1 014620026

275x182x64 mm

1462CF-SN

Offene Gelenk-Sechskantsteckschlüssel für Kraftstoffinjektorenanschlüsse



mm	€	1	014620032
12	29,00	1	014620032
14	29,50	1	014620034
16	31,50	1	014620036
17	32,00	1	014620037
18	33,00	1	014620038
19	34,00	1	014620039

1462/KI

Werkzeugsortiment zum Abziehen von Common-Rail-Diesel-Einspritzern

Zum Entfernen der Einspritzer DELPHI-BOSCH-SIEMENS-DENSO



1462/KI € 2.980,00 1 014620235

530x470x140 mm - 2,0 kg

1462/KU

Universal-Werkzeugsortiment zum Abziehen von Diesel Common-Rail-Einspritzdüsen

Komplett mit Zange und Schlaggewicht



1462/KU € 888,00 1 014620100

390x290x100 mm - 4,5 kg

1462/MB

Schlagmassekit zum Abziehen von Einspritzdüsen

Kitinhalt:

- 1 Schlagmasse (4 kg) mit Stange (400 mm)
- 1 Gelenkadapter, männlich M10x1,5, weiblich M22x1,5 mm
- 1 Adapter, männlich M22x1,5, weiblich M13x1,4 mm
- 1 Adapter, männlich M14x1,5, weiblich M27x1 mm
- 1 Adapter, männlich M14x1,5, männlich M25x1 mm
- 1 Adapter, männlich M14x1,5, weiblich M14x1,5 mm
- 1 Adapter, männlich M14x1,5, weiblich M20x1 mm
- 1 Adapter, männlich M14x1,5, männlich M17x1 mm



1462/MB € 358,00 1 014620110

500x250x80 mm - 7,2 kg

1462AD/BSC

Adapter zum Abziehen von Common-Rail-Einspritzdüsen Bosch

Zu verwenden mit Artikeln Beta 960KI und Beta 1462/KU



1462AD/BSC € 258,00 1 014620435

1462AD/SMN

Adapterkit zum Abziehen von Einspritzdüsen Siemens und Denso

Zu verwenden mit Artikel Beta 960KI/1462KI



1462AD/SMN € 386,00 1 014620436

1462/EI

Universal-Vibrationswerkzeug zum Abziehen der Injektoren

- Erleichtert das Entfernen stark verklemmter Injektoren aus der Aufnahme, ohne den Zylinderkopf zu beschädigen. Verhindert mögliche Brüche.
- Verwendbar mit jedem Satz Einspritzdüsenabzieher mit oder ohne Ausschläger
- Das Werkzeug wirkt direkt mit Vibrationen und Impulsen auf die Abziehstange, die mit dem Injektor verbunden ist
- Über das Regelventil kann die Stärke der Vibration dem durchzuführenden Eingriff angepasst werden.

CE



1462/EI € 786,00 1 014620240

Beta
WORLDWIDE PARTS

1463/KIT

Werkzeugsatz Blockierung
Riemenscheiben Ventiltrieb



1463/KIT € 479,00 1 014630001
280x140x75 mm - 1,2 kg

1464T

Digitaler Tester für die Messung
von Druck und Kompression



Mit dem Kit 960AD/TP2 ist die Prüfung möglich von:

- Kompression Benzin- und Dieselmotoren
- Motoröldruck
- Niederdruck-Common Rail
- Einspritzdruck Benzin

Mit dem Kit 1464AP ist die Prüfung möglich von:

- Istdruck Common Rail Kreislauf
- Druck Hochdruckpumpe

EIGENSCHAFTEN

- Touchscreen Display 5"
- Aufladbare Lithium-Polymer-Batterie
- Komplett mit 80 bar Sensor (Niederdruck) und USB-Kabel

1464T € 1.045,00 1 014640050

1464T/SP80

Druckfühler, 80 bar,
für Art. 1464T und Art. 960TP



1464T/SP80 € 359,00 1 014640053

960AD/TP2

Adaptersatz für Art. 960TP
im Kunststoffkoffer



960AD/TP2 € 619,00 1 009600510
430x310x50 mm - 3,2 kg

1464CBD

Kompletter Adaptersatz zur Druckprüfung in
Benzin- und Dieselmotoren
mit Art. 1464T

Ermöglicht den Anschluss an den Motor für den
Kompressionstest in Benzin- und Dieselmotoren mit
Digitaltester Art. 1464T

Enthält:

- 8 Zündkerzen mit Rückschlagventil
- 44 Prüflühkerzen mit Rückschlagventil
- 1 Universal-Prüfeinspritzdüse, verstellbar, für PKWs, LKWs, Schiffsgasturbinen und Landmaschinen
- 1 90°-Adapter, Druckablassventil und Anschlussrohr
- Raum zur Aufnahme des Digitaltesters Art. 1464T innerhalb des Koffers



1464CBD € 853,00 1 014640300
510x410x140 mm - 5,5 kg

1464IC

Prüfsatz mit Prüfeinspritzdüsen und
Prüflühkerzen für Art. 1464T

Ermöglicht den Anschluss an den Motor für den
Kompressionstest in Dieselmotoren
mit Digitaltester Art. 1464T.

Enthält:

- Nr. 22 Prüflühkerzen
- Nr. 5 Prüfeinspritzdüsen
- Nr. 1 Universal-Prüfeinspritzdüse für PKWs, LKWs, Bootsmotoren und Landwirtschaftsmaschinen



1464IC € 700,00 1 014640350
559x312x50 mm - 4,5 kg

1464IC/RK

Prüfkit Prüfeinspritzdüse für PKWs, LKWs,
Bootsmotoren und Landwirtschaftsmaschinen

Eingeschlossen im m Art. 1464IC



1464IC-RK € 227,00 1 014640377
200x110x30 mm - 885 g

1464AP

Satz zur Prüfung der Hochdruckanlage der
Common Rail Dieselmotoren,

mit Art. 1464T.

Komplett mit:

- Satz Hochdruckleitungen
- Verbindungsanschlüsse
- 2.000 bar Sensor



1464AP € 943,00 1 014640450
430x310x50 mm - 1,8 kg

1464AP T

Hochdruckleitung
für Art. 1464AP und Art. 960TAP



1464AP T12X12 € 73,50 1 014640453
1464AP T12X14 € 73,50 1 014640454
1464AP T14X12-M1,0 € 73,50 1 014640455

1464AP T16X12



1464AP T16X12 € 87,00 1 014640456

1464FG

Satz Falschregler zur Prüfung des Common-Rail-Dieselsystems (zu verwenden mit Beta 1464T-1464AP)

Zusammen mit dem Gebrauch von Testern und den geeigneten Adaptern kann bei fehlendem Druck im Hochdruckkreis von Common-Rail-Dieselmotoren festgestellt werden, ob das Problem in der Hochdruckpumpe oder im Druckregler liegt.
Geeignet für die Druckregler von Bosch, Delphi, Denso und Siemens



1464FG € 364,00 1 014640470
350x250x80 mm - 1,8 kg

1464FG/CP4

Falschregler für Pumpe Bosch CP4 nicht eingeschlossen in Art. 1464FG



1464FG/CP4 € 53,00 1 014640475

1464APB

Satz zur Prüfung der Hochdruckanlage von FSI-Benzinmotoren, für Art. 1464T

Mitgeliefert 200 bar Sensor und Verbindungsanschlüsse



1464APB € 464,00 1 014640500
240x210x50 mm - 0,5 kg

1464PB

Satz von 9 Anschlüssen für die Prüfung des Kraftstoff-Niederdrucksystems (zu verwenden mit 1464T)

Mittels der an den Tester 1464T angeschlossenen Schnellanschlüssen kann schnell der Kraftstoff-Niederdruck in Diesel- und Benzinmotoren geprüft werden



1464PB € 645,00 1 014640700
530x440x120 mm - 3,8 kg

1464ADB

Set für die Druckprüfung des AdBlue®-Systems für Art. 1464T

Geliefert mit Adaptern verwendbar mit dem Standardsensor 80 bar im Art. 1464T



1464ADB € 108,00 1 014640620
240x210x50 mm - 0,5 kg

1464FAP

Set für die Druckprüfung des Dieselpartikelfilters DPF für Art. 1464T

Geliefert mit:
- Sensor 500 mbar
- 8 mm Adapter mit Schnellanschluss und T-Anschluss
- RJ45-Kabel, 3 Meter



TECHNISCHE DATEN
Drucktest: 0÷500 mbar
Auflösung: 1 mbar

1464FAP € 230,00 1 014640610
240x210x50 mm - 0,5 kg

1464PT

Satz zur Prüfung des Turboladerdrucks für Art. 1464T

Mitgeliefert Sensor und Verbindungskabel



1464PT € 203,00 1 014640550
240x210x50 mm - 380 g

1464TDI

Satz zur Prüfung des Pumpendrucks in den TDI-Motoren, für Art. 1464T

Mitgeliefert Verbindungsanschluss



1464TDI € 146,00 1 014640600
240x210x50 mm - 400 g

1464VD

Prüfsatz für Unterdruck-/Vakuum für Art. 1464T

Ermöglicht die Messung und Speicherung des Max. Unterdruckwertes

Geliefert mit:
- Sensor 800 mbar
- Adapter 6 und 8 mm
- RJ45-Kabel, 3 Meter

TECHNISCHE DATEN
Vakuumentest: 0÷800 mbar
Auflösung: 1 mbar
Speicherung des Höchstwertes



1464VD € 230,00 1 014640570
240x210x50 mm

 Beta

1464PF

Satz zur Prüfung des Drucks in der Bremsanlage, für Art. 1464T

Mitgeliefert Adaptern und Anschlüsse



1464PF € 832,00 1 014640650
260x280x60 mm - 3 kg

1465

Motoreffizienz Prüfgerät

Ermöglicht in nur wenigen Sekunden, die Kompression von endothermischen Motoren zu prüfen, ohne sich an den Motor anschließen zu müssen, da die Spannungsversorgung über die Fahrzeugbatterie mittels einer entsprechenden Software erfolgt



1. Phase: Motor/Drehzahl Berechnung
2. Phase: Analyse des Batteriespannungsverlaufs während jeder Umdrehung
3. Phase: Anzeige der elektrischen Leistungsaufnahme und der mittels der Arbeit des Starters für jeden Kolben berechneten relativen Kompression
4. Phase: Prüfung des Ladungszustand und der Effizienz der Batterie
- TECHNISCHE DATEN
Betriebsspannung: 12V DC (Fahrzeugbatterie)
Abmessungen: 140x75x30 mm
Kabellänge der Klemmen: 1300 mm
Gewicht: 215 g

1465 € 1.400,00 1 014650010

1466/C5

Schlüsselsatz für Bremsenentlüftung, 5-teilig

- Im Satz inbegriffen:
• 5 Schlüssel Maß 7-8-9-10-11 mm
• 1 Ablassschlauch mit Rückschlagventil



1466/C5 € 154,00 1 014660100
260x170x50 mm - 600 g

1466L 11

Schlüssel 11 mm für Bremsenentlüftung lange Ausführung



1466L 11 € 38,00 1 014660211
11 mm L 60 mm

1466TLF

Auffangkanister Bremsenöl Fassungsvermögen 1,5 Liter

Schnellanschluss für Entlüftungsleitung Ø 5,5 mm



1466TLF € 55,00 1 014660201

1467

Instrument zur Absaugung von Bremsflüssigkeit



Min. Druck: 5 bar - Max. Druck 11,5 bar

1467 € 408,00 1 014670001

1467/RK1

Satz Ersatzschlauch für Art. 1467



1467/RK1 € 30,50 1 014670501

1467/RK2

Ersatznachfüllbehälter für Art. 1467



1467/RK2 € 118,00 1 014670502

1467LF/2

Elektrisches Gerät für den Austausch der Bremsflüssigkeit Mit „Impulswirkung“



- Automatik-Stopp bei leerem Tank, der den Lufteintritt verhindert
 - Maximales Tankvolumen: 20 l
 - Betriebsdruck: 0,4+3,5 bar
 - Versorgung: 230V
- Ausstattung inbegriffen:
- Tank zur Rückgewinnung der Bremsflüssigkeit
 - 1 Stopfen E20 Standard

1467LF/2 € 2.130,00 1 014670099

1467LF/RC

Rückgewinnungsschlauch für Art. 1467LF



1467LF RC € 130,00 1 014670125

1467TU

Stopfen für Bremsölvannen

- Anpassbar für 90% der Wannen des Fahrzeugbestands
- Verwendbar für Artikel Beta 1467LF



1467TU	€ 80,00	1	014670090
--------	---------	---	-----------

1467T/C6

Adapterstopfensatz für Bremsflüssigkeitswannen, verwendbar mit BETA Art. 1467LF und Art. 1467LF/2

Satzinhalt:

- 1 Stopfen für Fahrzeuge Toyota
- 1 Stopfen für Fahrzeuge Ford, Hyundai, Mazda, Mitsubishi, Nissan, Subaru
- 1 Stopfen für Fahrzeuge Honda
- 1 Stopfen für Fahrzeuge Mazda und Suzuki
- 1 Stopfen für Fahrzeuge Nissan
- 1 Adapterstopfen zur Bremsenentlüftung an europäischen Fahrzeugen



1467T/C6	€ 324,00	1	014670080
----------	----------	---	-----------

350x240x85 mm - 1,8 kg

1470

Bremsfederzangen für Trommelbremsen



L mm	€	1	014700001
210	47,50	1	014700002
330	61,00	1	014700010
540	183,00	1	014700010

1470FT

Bremsfederzange für Trommelbremsbacken

Backen 40° abgewinkelt
Müheloser Zugang zu schwer zugänglichen Stellen



L mm	€	1	014700000
184	50,50	1	014700000

1470PF

Werkzeug für den Austausch der Bremszylinder in Trommelbremsen
Die Bremsbacken bleiben gespreizt, so dass der Zylinder problemlos gewechselt werden kann

38"

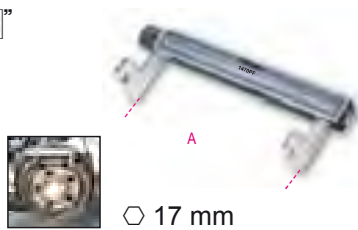

17 mm

A mm	€	1	014700200
25÷140	91,50	1	014700200

1471

Bremsfederzange für Trommelbremsen



L mm	€	1	014710001
330	92,50	1	014710001

1471A

Bremsseilfederzange



A max mm	B mm	€	2	014710010
45	5	113,00	2	014710010

1471GF

Paar modellierbare Haken zur Abstützung der Bremszange während dem Bremsbelagwechsel



1471GF	Max kg	€	1	014710310
	5	17,10	1	014710310



1471M/C22

Druckluftwerkzeug zum Zurückdrehen und Drehen der rechts- und linksgängigen Scheibenbremskolben mit Zubehör



1471M/C22	€ 364,00	1	014710101
-----------	----------	---	-----------

350x310x85 mm - 3,5 kg

1471M/50

Bremskolben-Rückstellgerät für rechts- und linksgängige Kolben, Druckluft unterstützt

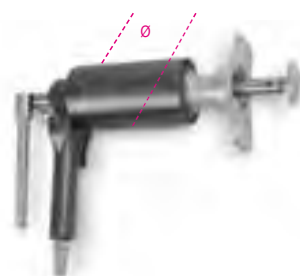

Ø mm	Kg	Bar	€	1	014710069
50	150	5÷8	201,00	1	014710069

1471M/P

Adapter für verschlissene Beläge und Zangen TRW-Mégane



1471M/P	€ 31,50	1	014710080
---------	---------	---	-----------

1471M/W50

Adapter für Standbremse VW Passat nach 2005

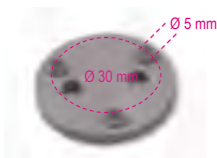

1471M/W50 € 11,10 1 014710079

1471PN/B1

Adapter für Standbremse Ford

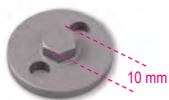

1471PN/B1 € 11,10 1 014710081

1471PN/B2

Adapter für Standbremse Daily



1471PN/B2 € 15,20 1 014710082

1471PN/B3

Adapter für Standbremse BMW



1471PN/B3 € 11,10 1 014710083

1471PN/B4

Adapter für Standbremse BMW

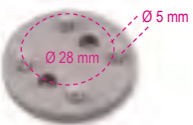

1471PN/B4 € 11,10 1 014710084

1471PN/B5

Adapter für Standbremse Mini/ BMW

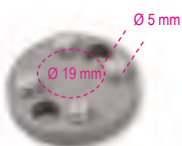

1471PN/B5 € 9,60 1 014710085

1471CF

Fünfkant-Steckschlüssel für Bremszangenmuttern



mm € 14 21,50 1 014710314
19 21,50 1 014710319

1471CM

Fünfkant-Steckschlüssel für Bremszangenschrauben



mm € 10 21,50 1 014710360

1471CM/E11

Sechskant-Steckschlüssel, 11 mm, für Bremszangen Mercedes ML (Serie 166)

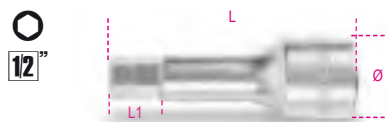

mm € 11 22,70 1 014710361
Ø mm 24
L mm 75
L1 mm 15,5

1471PT/C5

Kraftsteckschlüsselsatz für Bremszangenmuttern

Für PKWs der Gruppe Volkswagen, Audi und Porsche
• 3 10-Zahn-Kraftsteckschlüssel: 11,5 mm - 15 mm - 20 mm
• 2 7-Zahn-Kraftsteckschlüssel: Ø 14 mm - 22 mm



1471PT/C5 € 87,00 1 014710367



1471D2

Rückzieher für Scheibenbremsenkolben mit geschlossenen Zangen



mm € 10 94,00 1 014710301
250x170x60 mm 1,5 kg

1471T/C5

5 Schlagschlüssel für LKW-Bremssattel

Beim Anziehen mit Drehmomentschlüssel verwendbar
Abmessungen:

- Torx-Schrauben mit Innenvierkanttrieb, E18, E20, E24
- Ringschlüssel M24, M26



1471T/C5 € 302,00 1 014710400

275x220x60 mm - 3,1 kg

1472

Schlauchklemmenzange

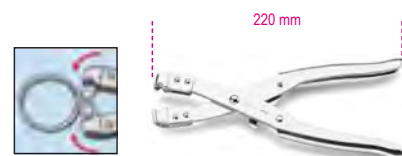

1472 € 53,00 1 014720001

1472AU

Automatische Schlauchklemmenzange

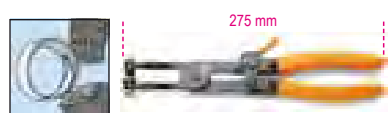

Ø mm € 18+53 156,00 1 014720100

1472R/AU

Ersatzspitzen für Zange Art. 1472AU



1472AU/R € 59,50 1 014720101

1472AU/P

Automatische Schlauchklemmzange mit Verlängerung



∅ mm 18÷54 L mm 630 € 137,00 1 014720105

1472AU/RP

Ersatzkabel für Zange Art. 1472AU/P



1472AUP/R € 33,50 1 014720106

1472B/RNLT

Doppelform-Spezialsteckschlüssel für Ansaugstutzen-Schellen, Motoren der Renault-Gruppe



1472B/RNLT € 21,70 1 014720250

1472FC

Zange mit schwenkbarem Kopf, für Schnappklemmen



1472FC € 49,00 1 014720090

1472FC/GE

Anpresszange, für Click-Schellen®

Insbesondere für großdimensionierte Schellen geeignet



L mm 230 € 86,00 1 014720093

1472FC/L

Zange mit flexibler Verlängerung, für Schnappklemmen



L mm 630 € 132,00 1 014720095

1472FCL/RP

Ersatzkabel für Zange Art. 1472FC/L



1472FCL/RP € 58,50 1 014720096

1472FCA

Zange für Entfernung von Klemmschellen mit Zahnstange Typ Visa®

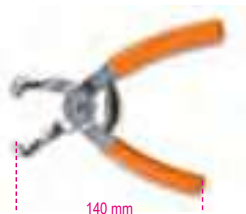

1472FCA € 74,00 1 014720041

1472H

Werkzeug zum Entfernen von Henn-Schlauchklemmen



L mm 100 € 28,50 1 014720000

1472MT/VW

Trennklemmen Ansaugkrümmer VAG Gruppe, 1 Paar

Zur Verwendung mit Turbo-Benzinmotoren 1.0 - 1.2 - 1.4



1472MT/VW € 14,10 1 014720500

1472TM

Zange zum Lösen der Schnellanschlüsse von Multijet-Filtern



1472TM € 34,50 1 014720200

1472VW

Schlauchklemmzange mit schwenkbarem Kopf für Fahrzeuge der Gruppen Volkswagen und Mercedes



1472 VW € 55,50 1 014720051

1473

Zange für OETIKER®-Klemmen



1473 275 € 154,00 1 014730001

1473A

Zange mit Ösenhalter für OETIKER®-Klemmen



1473A € 117,00 1 014730010

1473P

Klemmzange für OETIKER®-Klemmen mit niedrigem Profil



1473P A Max mm 53 € 43,50 1 014730020

1473FN

Werkzeug zum Anziehen und Schneiden von Klemmen aus Edelstahl

Verwendbar mit Panduit(R) Klemmen und ähnliche



A mm 4,7÷9,5 € 80,00 1 014730501

1473T

Schneidzange zum Entfernen von Stahlschellen

Ermöglicht das Schneiden der Schellen ohne die Gefahr, Kappen, Muffen usw. zu beschädigen



A Max mm 14 L mm 220 € 72,50 1 014730582

1474/C4

Satz Ausziehwerkzeug, 4teilig, für Zündspulen Volkswagen



1474/C4 € 122,00 1 014740100
290x190x50 mm - 1 kg

1474E/VW

Spreizabzieher für Zündspulen Gruppe Volkswagen



1474E/VW € 33,50 1 014740120

1474E/VW2

Zündspulenabzieher Fahrzeuge VAG-Gruppe

Verwendbar für Motoren 1.0 - 1.2 - 1.4 - 2.0



1474E/VW2 € 41,00 1 014740150

1474L

Zange für Zündkerzenstecker, Backen 15° gebogen, lang

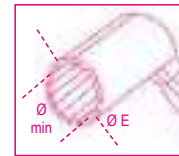

Ø min mm 14 Ø E mm 20 € 97,50 2 014740010

1474DL

Zange für Zündkerzenstecker, lang, Griffe mit zweischichtigem Überzug aus PVC

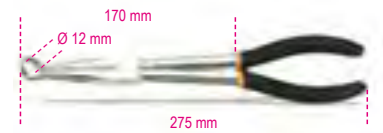

1474DL € 47,00 1 014740015

1474G

Zange mit langen gebogenen Backen für Glühkerzenstecker



1474G € 52,50 1 014740200

1475U

Universalzange, verchromt, poliert, Pistolengriff, mit zweischichtigem Überzug aus PVC



1475U € 49,00 1 014750010

1476
Gripzange mit Auspuffrohabschneider



Ø min mm	Ø max mm	L mm	€	Icon	Icon	Icon
19	75	225	94,00	1	014760002	

1476/RC
Ersatzkette für Art. 1476



1476RC	€ 46,50	1	014760012
--------	---------	---	-----------

1476A
Auspuffrohabschneider



Ø min mm	Ø max mm	€	Icon	Icon	Icon
30	95	120,00	1	014760005	

1476A/RC
Ersatzkette für Art. 1476A



1476A/RC	€ 103,00	1	014760015
----------	----------	---	-----------

1476C/1
Aufweitgeräte für Auspuffrohre



1476C/1	€ 45,00	1	014760101
Ø 30+42 mm			
L = 131 mm			
L1 = 51 mm			

1476GT
Zange zum Entfernen der Gummihalter für Auspuffrohre



L mm	A Max mm	± mm	€	Icon	Icon
280	58	3	41,50	1	014760050

1476PSA
Zange für Abgasschelle mit Stift, Gruppe PSA
Die Form der Greifbacken und die automatische Sperre der Zahnstange ermöglichen das Arbeiten, ohne den Stift abzuziehen



L mm	A Max mm	S mm	€	Icon	Icon
309	60	12,2	51,00	1	014760060

1476T
Schlüssel für Ausbau/Einbau Turbinen an Dieselmotoren, Gruppe Volkswagen Audi



Ø mm	€	Icon	Icon
12	46,50	1	014760200

1477/C10
Winkelringschlüssel mit 9 Einsätzen für Riemenscheibenmuttern

1 Winkelringschlüssel mit Anschluss für Einsätze
4 doppelte Zwölfkant-Einsätze: 12x14 - 13x15 - 16x17 - 18x19 mm
5 Einsätze für Torx®-Schrauben: E10 - E12 - E14 - E16 - E18



1477/C10	€ 197,00	1	014770310
530x110x55 mm			

1477D
Ringschlüssel für Riemenscheibenmuttern



Ø mm	€	Icon	Icon
13	35,00	1	014770113
15	35,00	1	014770115
16	35,00	1	014770116
17	35,00	1	014770117
19	35,00	1	014770119

1477D/S5
Ringschlüsselsatz für Riemenscheibenmuttern, 5teilig



1477D/S5	€ 176,00	1	014770200
13-15-16-17-19 mm			
600x200x70 mm - 2,2 kg			

1477K/7
Winkelringschlüsselsatz mit Umschaltknarre und Einsätzen



- 2 Einsätze TORX T40-T45
- 1 Einsatz XZN 10
- 1 Sechskant-Einsatz 8 mm
- 3 Zwölfkant-Einsätze 10-12-13 mm

1477K/7	L mm	€	Icon	Icon
	250	172,00	1	014770051

1478
Spezialzange für Befestigungsclips



1478	€ 68,00	1	014780001
------	---------	---	-----------

1478NSS

Zange für Kunststoffstifte mit 3 Entriegelungspunkten



L mm 180 € 49,00 1 014780163

1478T

Zange mit schwenkbarem Kopf für Kunststoffstifte mit Druckclips

90° schwenkbarer Kopf



S mm 4,5 € 53,00 1 014780101

1478/K3

Satz Spezialzangen für Befestigungsclips, mit Sortiment aus Kunststoffclips

Kitinhalt:

- 1 Zange mit geraden Backen
- 1 Zange mit um 90° gebogenen Backen
- 625 Kunststoffclips in 16 verschiedenen Größen
- Clips sind in 3 stapelbaren PPL-Behältern enthalten

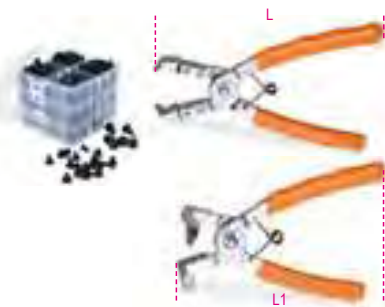

L mm 180 L1 mm 170 € 124,00 1 014780160

1478SP

Sortiment aus 625 Kunststoffclips

16 verschiedene Typen



€ 29,50 1 014780201

1479

Spezialwerkzeug zum Entfernen von Befestigungsclips



1479 € 30,50 2 014790001

1479/B27

Nylon-Werkzeug Sortiment für Entfernung von Zylinderstiften und Arbeit an Kunststoffbauteilen und Dichtungen, 27-teilig in Hängetasche



1479/B27 € 94,00 1 014790407

1479LB/C5

Spezialwerkzeugsatz zum Entfernen von Befestigungsclips aus Metall, 5-teilig



1479LB/C5 € 129,00 1 014790150
215x165x50 mm

1479L/S2

Paar Multifunktions-Abziehhebel aus Teflon®



1479L/S2 € 43,00 1 014790510

1479LV/S3

Multifunktions-Abziehhebelsatz aus Metall, 3-teilig

Maße:
1479LV/1: 10x12 mm
1479LV/2: 4,8x9,6 mm
1479LV/3: 2,8x6 mm



1479LV/S3 € 36,50 1 014790100

1479L/K4

4 Abziehhebel für Arbeiten an Armaturenbreitern und empfindlichen Komponenten



1479L/K4 € 41,00 1 014790604

1479ML/B17

Multifunktions-Abziehhebelsatz aus Kunststoff, 17-teilig

Besonders geeignet für Präzisionsarbeiten



1479ML/B17 € 77,00 1 014790700

1479ML/S3

Satz mit 3 Multifunktions-Abziehhebel aus Kunststoffmaterial

Besonders geeignet für Präzisionsarbeiten



1479ML/S3 € 13,20 1 014790603

1479N/S5

Spezialwerkzeugsatz zum Entfernen von Befestigungsclips aus Nylon, 5teilig



1479N/S5 € 48,50 1 014790251

1479RB/1

Schaber mit Aufsatz, gerade Ausführung



1479RB/1 € 33,50 1 014790315

1479RB/2

Schaber mit Aufsatz, gebogene Ausführung



1479RB/2 € 33,50 1 014790320

1479RB/3

Schaber mit Aufsatz, flache Ausführung



1479RB/3 € 38,00 1 014790310

1479U/13

Spezialwerkzeug zum Entfernen von Befestigungsclips, Messer aus Edelstahl

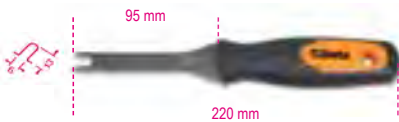

1479U/13 € 30,50 2 014790010

1479U/32

Spezialwerkzeug zum Entfernen von Befestigungsclips, Messer aus Edelstahl



1479U/32 € 36,50 2 014790015

1480

Dieselfilter-Befüllkit für Fahrzeuge ohne elektrische Pumpe
• Verwendbar auch mit Aufpumpspistole für Reifen

Der Kit enthält:

- Schnellanschlüsse GM
- Schnellanschlüsse Renault, GM, Fiat Innen-Ø 6 mm
- Schnellanschlüsse Renault, GM, Fiat Innen-Ø 7 mm
- Schnellanschlüsse Ford
- Schnellanschlüsse PSA Innen-Ø 6 mm
- Schnellanschlüsse PSA Innen-Ø 7 mm
- Schnellanschlüsse Ford
- 2 konische Adapter für Fahrzeuge ohne Schnellanschlüsse



1480 € 456,00 1 014800010

410x320x70 mm

1481/C12

Satz 6 Paare Zangen für Leitungsverschlüsse

Der Satz umfasst:

- 2 unterschiedliche Paare Zangen für Zoll 1/4"
- 2 unterschiedliche Paare Zangen für Zoll 3/8"
- 2 unterschiedliche Paare Zangen Zoll 5/16"
- 3 Paare Gummistopfen



1481/C12 € 145,00 1 014810312

370x270x59 mm

1481K/S4

Kit 4 selbstspannende Klemmen für Leitungsverschluss

Maße: 5/16" - 3/8" - 1/2" und Durchführung



1481K/S4 € 36,50 1 014810400

1481PL/A

Kunststoffzange für Leitungs- und Muffenverschlüsse

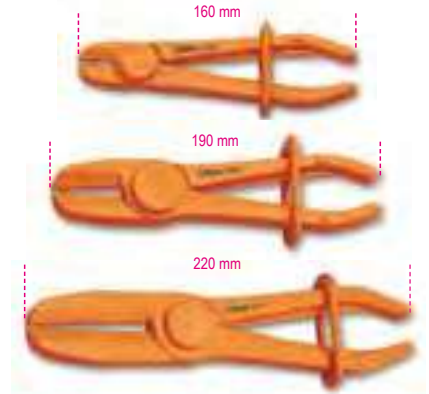

	Ø mm	€		
1481PL/A	8÷15	24,70	3	014810110
1481PL/B	15÷25	28,00	3	014810120
1481PL/C	25÷45	37,50	3	014810130

1481PL/S3

Satz mit 3 Kunststoffzangen für Leitungs- und Muffenverschlüsse

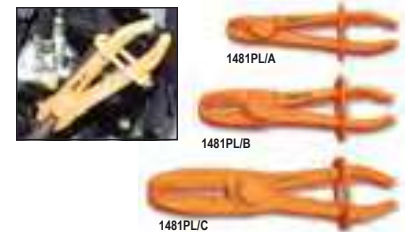

1481PL/S3 € 90,00 1 014810200

1481PL-A Ø 8÷15 mm
1481PL-B Ø 15÷25 mm
1481PL-C Ø 25÷45 mm



1481T/C12

Kraftstoffleitungs-Verschlussstopfen-Satz

3 Paare Stopfen mit Schnellkupplung mit Innen-/ Aussengewinde zum Verschließen von Kraftstoffleitungen



1481T/C12 € 150,00 1 014810212
 275x220x45 mm - 540 g

1482

Tankschwimmerschlüssel, verstellbar und selbstspannend



Ø mm € 135,00 1 014820001
 89÷170 € 141,00 1 014820002

1482A/1

3-Klauen-Schlüssel für Tankschwimmer für Nutmutter aus Aluminium

Zum Eingriff an Nutmuttern aus Aluminium, die ab 2011 an Fahrzeugen der Gruppen Fiat, Volkswagen, Opel, Chevrolet, Mercedes und BMW verbaut sind



Ø mm € 92,50 1 014820005

1482A/3

Schlüssel für Tankschwimmer Nutmutter Gruppe PSA

Das Design ermöglicht das Arbeiten an der außermittigen Achse durch Entfernen der Nutmutter, ohne das empfindliche Ansaugrohr zu beschädigen



Ø mm € 106,00 1 014820007

1482A/5

22-Haken-Schlüssel für Tankschwimmermuttern

Zum Arbeiten an Kunststoffnutmutter montiert an Fahrzeugen der Gruppe VAG



Ø mm € 81,00 1 014820015

1482/8 - 1482/10

Zangen für Schnellanschlüsse von Kraftstoffleitungen

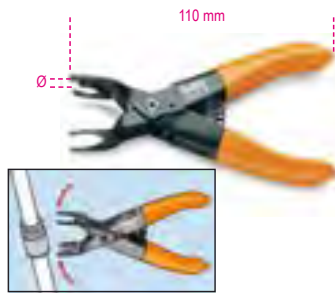

Ø mm € 46,50 2 014820008
 1482/10 € 46,50 2 014820010

1482B

Zange für Schnellanschlüsse von Kraftstoffleitungen



1482B € 55,50 1 014820021

1482SN

Gelenkzange für Schnellanschlüsse von Kraftstoffleitungen



L mm € 71,00 1 014820110

1482C

2 Paar Keile zum Lösen des Dieselfilteranschlusses Gruppen Fiat, Volkswagen, Jeep, Chrysler und Volvo

Schneller Austausch des Filters, ohne die Anschlüsse unwiderruflich zu beschädigen



1482C € 73,50 1 014820022

1482D

Zange mit flexibler Verlängerung für Schnellanschlüsse Kraftstoffleitungen



1482D € 102,00 1 014820026

1483K/12

Kit zum Ausbau der Ventile der Klimaanlage mit Satz von 5-spitzigen Einsätzen

Kitinhalt:
 • 2 Achtkant-Steckschlüssel Ø 12 und 15 mm für Hochdruckventile
 • 2 Maul-Steckschlüssel mit Außenvierkant Querschnitt 2,2 und 3,2 mm für Drosselventile
 • 1 Satz von 5-spitzigen Einsätzen verschiedener Abmessungen:
 PT10, PT15, PT20, PT25, PT27, PT30, PT40



1483K/12 € 48,50 1 014830012
 120x80x35 mm

1483KV-PT/S7

Satz von 5-spitzigen Einsätzen

Abmessungen:
 PT10 - PT15 - PT20 - PT25 - PT27 - PT30 - PT40



1483KV PT/S7 € 14,80 1 014830117

1483K/22

Satz zum Trennen von Anschlüssen an Klimaanlage, Versorgung und Schmierung



1483K/22 € 168,00 1 014830022
300x230x55 mm - 1 kg

1484

Satz aus 2 Werkzeugen zum Aus- und Einbau der elastischen Riemen

Gewährleistet einen schnellen Ausbau und eine korrekte Montage des elastischen Riemens ohne Beschädigungsgefahr



1484 € 149,00 1 014840010

1484PSA

Werkzeug für den Einbau des elastischen Riemens der Wasserpumpe ohne Riemenspanner

Verwendbar für Gruppe PSA und Opel Motoren 1.0 - 1.2



1484PSA € 19,30 1 014840012

1485BP

Halbmondwerkzeug zum Blockieren von Zahnscheiben

Verstellbar mittels Drehgriff, blockiert die Scheibe von außen, und verhindert so Schäden an Sensoren



A Max mm 130 € 264,00 1 014850000

1485BPM

Halbmondwerkzeug mit Aluminiumkrallen zum Blockieren von mehrfach gerillten Riemenscheiben

Verstellbar mittels drehbaren Griffs, die Riemenscheibe wird von außen angespannt und blockiert, so dass die umliegenden Sensoren nicht beschädigt werden können



A Max mm 180 € 228,00 1 014850002

1485FCA/K2

Werkzeugpaar zum Vorladen von Verteilerriemen-Lagern

Gruppe FCA

Geeignet für Motoren 1.2, 1.4 8/16 V und 1.4 Multiair

- 1 Werkzeug, Länge 175 mm, mit 13,5 mm Spitzen
- 1 Gelenk-Werkzeug, Länge 305 mm, mit 13,5 mm Spitzen



1485FCA/K2 € 123,00 1 014850220

1485FCA/T

Langes Spannwerkzeug für Verteilerlager mit Spitzen von 13,5 mm



L mm 175 P mm 13,3 € 44,00 1 014850210

1485FCA/TS

Gelenkspanner für Verteilerlager mit Spitzen von 13,5 mm



L mm 305 P mm 13,5 € 77,00 1 014850215

1485FRD/T

Hebel zum Spannen der an Ford Motoren verbauten Serviceriemen

Verwendbar für den Ausbau von Generator-Riemenscheiben



L mm 450 Q mm 12,80 € 94,00 1 014850310

1485MRC/T

Hebel zum Spannen der an Mercedes-Motoren verbauten Serviceriemen

Verwendbar für Motoren M133 - M270



L mm 510 Ø T55 € 38,50 1 014850315

1485VLV/T

Hebel zum Spannen der an Volvo-Motoren verbauten Serviceriemen

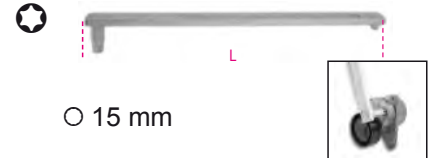

L mm 420 Ø T50-T60 Ø mm 15 € 79,00 1 014850320

1485TC

Hebel zum Spannen der an Ford, PSA, FCA Motoren verbauten Serviceriemen

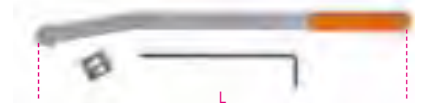

L mm 475 € 57,50 1 014850330

1485/KIT

Werkzeugsatz zur Spannungskontrolle des Verteilerriemens



1485/KIT € 214,00 1 014850100
230x140x75 mm - 580 g



1485MJ

Blockierwerkzeug Nockenwelle
Motoren 1.3 16V Multijet

2 Köpfe mit 3 Profilen zum Arbeiten an allen Motoren 1.3 16V
Multijet
montiert von Gruppe FCA, Opel, Ford und Suzuki



1485MJ	L mm 500	€ 149,00	1	014850150
--------	----------------	-------------	---	-----------

1485PMTJ

Entriegelungshebel
Kurbelwellenriemenscheibe Multijet
Eigens zur Blockierung der Kurbelwelle während den
Ausbauarbeiten der Riemenscheibe entworfene Geometrie



1485PMTJ	L mm 450	€ 155,00	1	014850190
----------	----------------	-------------	---	-----------

1485R

Universalgerät zum Drehen der
Verteilerriemenscheibe
aus Schmiedestahl
inkl. 2 Paar Spitzen



1485R	Ø mm 30÷120	Ø1 mm 10 - 17	L mm 500	€ 185,00	1	014850025
-------	-------------------	---------------------	----------------	-------------	---	-----------

1485R/P10

Spitzenpaare

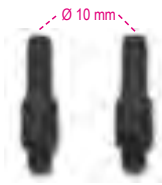

1485R/P10	€ 19,80	1	014850035
-----------	------------	---	-----------

1485R/P17

Spitzenpaare

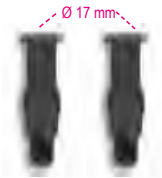

1485R/P17	€ 19,80	1	014850038
-----------	------------	---	-----------

1485VAG/K2

Werkzeugpaar zum Vorladen
von Lagern Verteilerriemen

- In 3 Positionen schwenkbarer Kopf
- 1 Werkzeug mit tiefem Kopf 12,5 mm
- 1 Werkzeug mit tiefem Kopf 21,5 mm

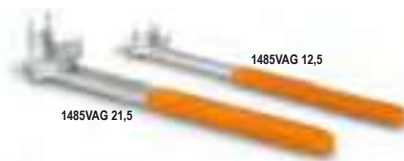

1485VAG/K2	€ 91,50	1	014850080
------------	------------	---	-----------

1485VAG

Werkzeug zum Vorladen von
Lagern Verteilerriemen

- In 3 Positionen schwenkbarer Kopf



1485VAG/12,5	L mm 190	P mm 12,5	€ 45,00	1	014850062
1485VAG/21,5	L mm 195	P mm 21,5	€ 46,50	1	014850071

1487/K2

2 Schlüssel für Kühlerablassschrauben



1487/K2	€ 33,00	1	014870100
---------	------------	---	-----------

1488 - 1488L

Ölfilterschlüssel mit Doppelkette
und Gelenk



1488	Ø mm 60÷110	€ 110,00	1	014880001
1488L	Ø mm 60÷160	€ 121,00	1	014880050

1488/1

Ölfilterschlüssel mit Doppelkette



1488/1	Ø mm 60÷110	€ 127,00	1	014880010
--------	-------------------	-------------	---	-----------

1488R...

Ersatzkette



1488RC	1488	350	€ 45,00	1	014880101
1488R/L	1488/L	520	€ 72,50	1	014880150
1488RC/1	1488/1		€ 62,50	1	014880110

1489/31T

Riemenscheibenschlüssel



1489/31T	15	31	€ 46,50	1	014890016
----------	----	----	------------	---	-----------

1489/33

Riemenscheibenschlüssel



1489/33	33	€ 19,70	1	014890010
---------	----	------------	---	-----------



1489/33P

Riemenscheibenschlüssel
neue Drehstromlichtmaschine Bosch
FIAT Grande Punto



M	mm	mm	€	1	014890015
10	15	31	58,50		

1489/E

Riemenscheibenschlüssel



mm	mm	€	1	014890025
10	15	39,50		

1489R

Riemenscheibenschlüssel



1489/R	€	1	014890020
	19,70		

1489/Y

Riemenscheibenschlüssel
Drehstromlichtmaschinen Nippondenso



mm	€	1	014890040
32	22,60		

1489/C14

Werkzeugsortiment, 14teilig, für die freien
Riemenscheiben der
Wechselstromgeneratoren



1489/C14	€	1	014890100
	351,00		

- 867PE 8 mm
- 867PE/L 8 mm
- 867XZN/L M10
- 867TX/L T50
- 867/2 □1/2"
- 920B 10 mm
- 1489/33
- 1489/33P M10
- 1489R
- 1489Y
- 1489/31T T50
- 1489/E 10 mm
- 188 10 mm
- 188 15 mm

420x250x45 mm - 1,9 kg

1490

Spannschlüssel für Ölfiltergehäuse

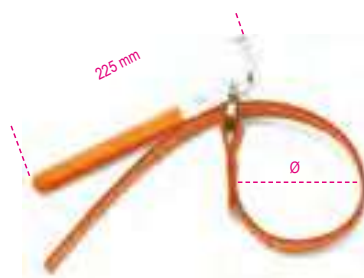

	∅ max mm	€	1	014900001
1490/1	160	44,00		
1490/2	240	47,00		014900002

1490/R1 - 1490/R2

Ersatz-Stoffbänder für Art. 1490



	∅ mm	€	1	014900101
1490R/1	160	21,20		
1490R/2	240	26,00		014900102

1490F

Spannschlüssel für Filtergehäuse



∅ Max mm	mm	€	1	014900201
200	50	32,50		

1491

Spannschlüssel für Ölfiltergehäuse



∅ mm	€	2	014910001
65÷110	56,50		

1491R

Ersatzband für Art. 1491



1491R	€	10	014910010
	10,40		

1491A

Verstellbare Ölfilterzange

Präzisionseinstellung mittels Gelenk



L mm	∅ min - Max mm	€	1	014910040
345	55 ÷ 140	38,50		

1491T

Verstellbare Zange für Ölfilter Truck

Präzisionseinstellung mittels Gelenk
Verwendbar für Trockenfilter



L mm	∅ min - Max mm	€	1	014910050
500	70÷200	90,00		



1492/1 - 1492/2

Spannschlüssel für Ölfiltergehäuse



	Ø mm	€		
1492/1	60÷80	53,50	1	014920001
1492/2	80÷110	56,00	1	014920002

1492T

Schlüssel für Trocknerfilter



	Ø mm	H mm	€		
1492T 40	125÷145	40	41,50	1	014920540
1492T 75	120÷140	75	72,50	1	014920575

1493B

Zwölfkant-Steckschlüssel für schwer erreichbare Ölfilterkartuschen



mm	± mm	€		
24	8	23,30	1	014930524
27	8	24,30	1	014930527
32	8	24,80	1	014930532
36	8	26,50	1	014930536
38	8	27,50	1	014930538

1493B/S5

Zwölfkant-Steckschlüsselsatz, 5-teilig, für schwer erreichbare Ölfilterkartuschen

Maße:
24-27-32-36-38 mm



	€		
1493B/S5	96,00	1	014930599

1493

Ölfiltersatz



Ø mm	N	€		
65	14	13,20	1	014930200
73	14	13,20	1	014930208
74	14	13,20	1	014930209
74	15	13,20	1	014930210
76	14	13,20	1	014930218
76-74	15	14,30	1	014930220
78	15	14,30	1	014930224
80	15	14,70	1	014930226
82-80	15	14,70	1	014930228
86	16	15,60	1	014930230
90	15	15,60	1	014930234
92	10	15,60	1	014930236
93	15	15,60	1	014930238
100	15	17,70	1	014930248
106	15	18,40	1	014930250
108	15	18,40	1	014930252
135	18	30,00	1	014930256

1493/PF

Purflux®-Ölfiltersätze



Ø mm	N	€		
66	6	13,20	1	014930202
76	12	13,20	1	014930216
76	30	14,30	1	014930222
86	18	15,60	1	014930232
93	36	15,60	1	014930240
93	45	15,60	1	014930242
96	18	15,60	1	014930246
108	18	19,80	1	014930254



1493/C30

Sortiment mit 28 Ölfiltersätzen



Im Satz inbegriffene Abmessungen (Ø mm / Anz. Seiten)
1493:

65/14 - 67/14 - 68/14 - 73/14 - 74/15
76/15 - 75.77/15 - 76/14 - 76/8 - 78/15 - 80/15
82/15 - 86/16 - 90/15 - 92/10 - 93/15 - 95/15
100/15 - 106/15 - 108/15

1493PF (Purflux)
66/6 - 76/12 - 76/30 - 86/18
93/36 - 93/45 - 96/18 - 108/18

- Inklusiv 1 verstellbarer Universalschlüssel
Ø 65÷120 mm

	€		
1493/C30	320,00	1	014930000

≡ 530x400x110 mm - 4 kg

1493AL

Ölfilterschlüssel

N= Nr. Seiten

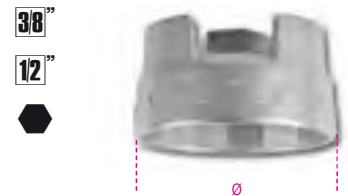

Ø mm	N	•	□	€		
64	14	27	1/2"	19,80	1	014930310
66,5	14	27	1/2"	17,70	1	014930315
74	14	27	1/2"	21,50	1	014930320
79	15	27	3/8"	19,80	1	014930325
84	14	27	3/8"	21,50	1	014930330
87	16	27	1/2"	26,50	1	014930335
92	15	27	3/8"	21,50	1	014930340
100,5	15	27	3/8"	21,50	1	014930350

1493AL 4S

Ölfilterschlüssel für asiatische Fahrzeuge
Profil mit 4 Haken



Ø1 mm	Ø2 mm	€		
70	64,5	21,50	1	014930304
80	64,5	19,80	1	014930305

1493AL CF

Sechskant-Steckschlüssel
für Ölfilterkartuschen



Ø mm	H mm	●	€	🔧	📦
24	34	27	12,80	1	014930424
30	34	27	12,80	1	014930430
32,5	34	27	13,20	1	014930432
36	34	27	13,20	1	014930436
38	34	27	13,20	1	014930438

1493/C19

Ölfilterschlüssel-Set, 18-teilig,
besonders geeignet für asiatische Fahrzeuge

Ø mm	Nr. Seiten
63-64	14
66,5	14
74	14
79	15
84	14
87	16
92	15
94,5	15
100,5	15
64,5	14 Hakenschlüssel für PKWs der Marke Toyota
64,5	14 Hakenschlüssel für PKWs der Marke Lexus
6 Sechskantschlüssel, Größe 24-27-30-32,5-36-38 mm, für Filterkartusche	
Set inkludiert einen universell justierbaren Schlüssel, Ø 58÷93 mm	



1493/C19	€	🔧	📦
279,00	1	014930019	

490x450x60 mm - 4 kg

1493DSG

Schlüssel für Aus-/Einbau
DSG Getriebeölfilter



Ø mm	€	🔧	📦
24	44,50	1	014930800

1493FF

Schlüssel für Ausbau/Einbau der
Kunststoffaufnahme von
Ölfiltren Ford Peugeot Citroën
Motoren: TDCi-HDi
Ermöglicht das korrekte Anziehen der Kunststoffaufnahme
mit Drehmomentschlüssel auf 25 Nm

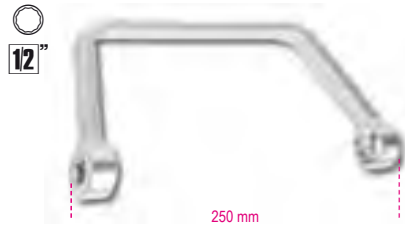

Ø mm	€	🔧	📦
27	36,50	1	014930127

1493FT

Schlüssel für Dieselfilter Ford Transit

Verwendung für alle Ausführungen
Transit, Transit Custom und Tourneo Custom
ab 2012



Ø mm	€	🔧	📦
115	30,50	1	014930085

1493J

Dieselölfiltersatz für Motoren
Multijet

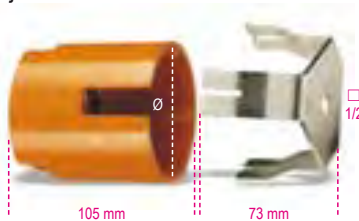

Ø mm	€	🔧	📦
90	141,00	1	014930080

1493VW

Dieselölfiltersatz
VAG und Volvo Gruppen



Ø mm	€	🔧	📦
82,5	20,50	1	014930086

1493HK

Dieselölfiltersatz, 15-seitig,
für Motoren Hyundai Kia



1493HK	€	🔧	📦
33,00	1	014930087	

1493/C7

Selbstspannender 3-armiger Ölfilterschlüssel,
rechts-linksgängig, mit auswechselbaren
Armen

Rutschfeste Diamantbeschichtung

- 2 Armserien:
• 1 Serie mit Nutzlänge 20 mm
• 1 Serie mit Nutzlänge 38 mm



1493/C7	Ø mm	Ø mm	€	🔧	📦
136,00	50÷100	16	1	014930079	

210x150x50 mm

1493H

Selbstspannender Ölfilterschlüssel,
rechts- und linksgängig, 3-armig

Rändelarme

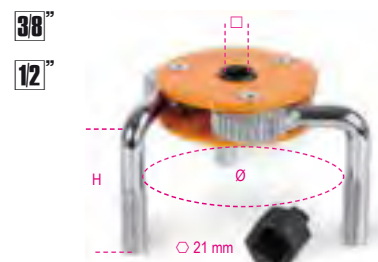

1493H	Ø mm	H mm	€	🔧	📦
33,50	72÷127	62	1	014930077	



1493/S-U

Selbstspannender Ölfilterschlüssel, rechts- und linksgängig, 3-armig

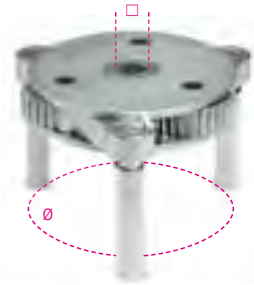

	□	∅ mm	€	🛠️	📄
1493/S	3/8-1/2	80-115	102,00	1	014930074
1493/U	1/2	105-165	223,00	1	014930076

1493X

Selbstspannende Ölfilterschlüssel linksgängig

38"

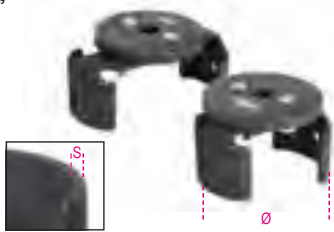

	∅ mm	± mm	€	🛠️	📄
1493X/1	60÷80	2,9	38,50	1	014930105
1493X/2	80÷98	2,9	38,50	1	014930110

1493Y

Selbstspannende Ölfilterschlüssel rechts-linksgängig schwere Ausführung

Der Artikel 1493Y/2 ist auch für Trockenfilter verwendbar

12"

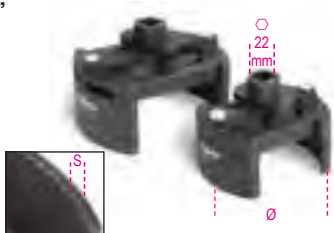

	∅ mm	± mm	€	🛠️	📄
1493Y/1	80÷110	7,3	132,00	1	014930120
1493Y/2	104÷145	7,3	201,00	1	014930122

1493C/ADB

Zange zum Öffnen von AdBlue®-Verschlüssen, Fahrzeuge der PSA-Gruppe

38"



1493C/ADB	€	20,00	🛠️	1	📄	014930900
-----------	---	-------	----	---	---	-----------

1493U/ADB

Zange zum Öffnen von AdBlue®-Ablassschrauben

38"



1493U/ADB	€	14,40	🛠️	1	📄	014930910
-----------	---	-------	----	---	---	-----------

1494T/C5

Satz mit Spezialschlüsseln für Ölverschlüssel aus Kunststoff

Satzinhalt:

- 1 Schlüssel für Ölverschlüssel, Fahrzeuge VAG-Gruppe
- 1 Schlüssel für Ölverschlüssel, Fahrzeuge BMW
- 1 Schlüssel für Ölverschlüssel, Fahrzeuge PSA-Gruppe und Ford
- 1 Schlüssel für Ölverschlüssel, Fahrzeuge Mercedes
- 1 Schlüssel mit T-Griff

38"



1494T/C5	€	87,00	🛠️	1	📄	014940350
----------	---	-------	----	---	---	-----------

≡ 173x125x50 mm - 📦 360 g

1494BMW

Spezialschlüssel für Ölverschlüsse aus Kunststoff BMW Motoren

38"



1494BMW	€	16,90	🛠️	1	📄	014940315
---------	---	-------	----	---	---	-----------

1494FPC

Spezialschlüssel für Ölverschlüsse aus Kunststoff Ford, Peugeot, Citroën Motoren

38"



1494FPC	€	19,10	🛠️	1	📄	014940320
---------	---	-------	----	---	---	-----------

1494VW

Spezialschlüssel für Ölverschlüsse aus Kunststoff

Motoren der Gruppe Volkswagen

Ermöglicht das Entfernen und die Installation des Kunststoffverschlusses.

Spezifisch für Fahrzeuge der Gruppe Volkswagen mit Motoren TFSI und TDI

38"



1494VW	€	26,50	🛠️	1	📄	014940305
--------	---	-------	----	---	---	-----------

1494MRC

Spezialschlüssel für Ölverschlüsse aus Kunststoff, Motoren Mercedes

38"



1494MRC	€	18,60	🛠️	1	📄	014940325
---------	---	-------	----	---	---	-----------

1494MAN

Spezialschlüssel für Ölverschlüsse aus Kunststoff, Motoren DAF und MAN

38"



1494MAN	€	18,60	🛠️	1	📄	014940330
---------	---	-------	----	---	---	-----------

1494

Steckschlüssel-Einsätze für Ölwannen, Viereckantrieb

12"



mm	€	🛠️	📄
10	11,20	1	014940280

1494E

Steckschlüssel-Einsätze für Ölwannen, Außensechskant

12"



mm	€	🛠️	📄
8	11,20	1	014940208
9	11,20	1	014940209
10	11,20	1	014940210
11	11,20	1	014940211
12	11,20	1	014940212
14	11,20	1	014940214
17	11,20	1	014940217



1494Q

Steckschlüssel-Einsätze für Ölwanne,
Außenviereckantrieb

12"



mm	€	U	IT
8	11,20	1	014940258
9,5	11,20	1	014940259
12	11,20	1	014940262
13	11,20	1	014940263

1494T

Steckschlüssel-Einsatz für Ölwanne,
Außendreieckantrieb

12"



mm	€	U	IT
9,5	11,20	1	014940289

1494XZN

Steckschlüsseinsatz für Ölwanne für
Vielzahnschrauben (XZN®)

12"



M	€	U	IT
16	13,20	1	014940296

1494VW/K

Satz für Motorölwechsel
VAG Gruppe



Inhalt des Satzes:

- 1 Spezialschlüssel für Kunststoffschraubverschlüsse
- 6 Kunststoffschraubverschlüsse für Wanne

1494VW/K	€	U	IT
	34,50	1	014940310

1494VW/KT

Kunststoffverschlüsselsatz, 6-teilig, für Art.
1494VW/K



1494VW/KT	€	U	IT
	30,00	1	014940311

1494/C14A

Werkzeugsortiment, 14teilig, für Ölwechsel

12"



1494/C14A	€	U	IT
	158,00	1	014940150

- 1494E 8-9-10-11-12-14-17
- 1494Q 8-9,5(3/8")-12-13
- 1494 10
- △ 1494T 9,5(3/8")
- 1494XZN M16

380x305x40 mm - 1,7 kg

1494M

Werkzeug für Sechskantverschlusschraube
Motoröl,
magnetisch und flexibel

Ermöglicht das Abschrauben der Verschlusschraube ohne
die Gefahr
von Verbrennungen und ohne sich zu verschmutzen

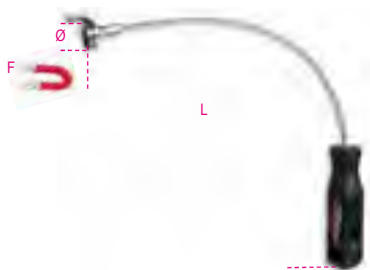

L mm	F kg	Ø mm	€	U	IT
293	2,5	19	28,50	1	014940401

1495/C6

Werkzeugsortiment für die Reparatur der
Ölwannegewinde



- Das beschädigte Gewinde wird mithilfe des Außengewindes entfernt und um eine Größe vergrößert
- Zur Reparatur ohne Ölwannewechsel

Bestehend aus:

- 1 Außengewinde M13x1.25 + 6 Schrauben + 12 Unterlegscheiben
- 1 Außengewinde M13x1.5 + 6 Schrauben + 12 Unterlegscheiben
- 1 Außengewinde M15x1.5 + 6 Schrauben + 12 Unterlegscheiben
- 1 Außengewinde M17x1.5 + 6 Schrauben + 12 Unterlegscheiben
- 1 Außengewinde M20x1.5 + 6 Schrauben + 12 Unterlegscheiben
- 1 Außengewinde M22x1.5 + 6 Schrauben + 12 Unterlegscheiben

1495/C6	€	U	IT
	342,00	1	014950500

420x185x60 mm - 2,1 kg

1495M

Außengewindeanschluss für Öldeckel



M	€	U	IT
13x1,25	20,60	1	014950553
13x1,50	16,90	1	014950563
15x1,50	18,40	1	014950565
17x1,50	20,60	1	014950567
20x1,50	22,70	1	014950570
22x1,50	30,00	1	014950572

1495T

Kit bestehend aus 6 Öldeckeln und
Unterlegscheiben



M	€	U	IT
13x1,25	24,00	1	014950503
13x1,50	24,00	1	014950513
15x1,50	24,00	1	014950515
17x1,50	26,50	1	014950517
20x1,50	30,50	1	014950520
22x1,50	39,00	1	014950522

1496/C

Ölwanenschlüssel



8 x 10 mm	€	U	IT
	26,50	3	014960010

1497D

Zange mit geraden Backen
zum Aus-/Abziehen von Relais



1497D	A min+Max mm	€	U	IT
	15÷50	39,50	1	014970150

1497BS

Zange mit geraden, dünnen Backen zum Aus-/Abziehen von Relais und Sicherungen

Die langen und äußerst dünnen Backen ermöglichen das Aus-/Abziehen von Relais und Sicherungen in engen Räumen

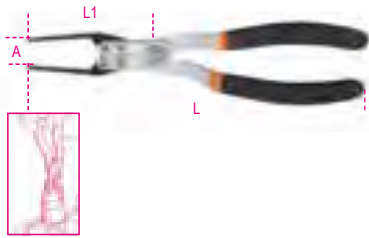

L	L1	A	€	Stk	Art-Nr
mm	mm	mm			
230	45	14	27,50	1	014970190

1497P

Zange mit um 60° gebogenen Backen zum Aus-/Abziehen von Relais



A	€	Stk	Art-Nr
min+Max mm			
15÷50	41,00	1	014970160

1497SS

Gripzange zum Schweißen verzinnter Drähte

Die oberen Clips ermöglichen die Befestigung und Annäherung der Schweißdrähte.

Anhand der integrierten Zahnstange können die Drähte in 6 verschiedene Lagen gebracht werden.



L	A	€	Stk	Art-Nr
mm	min+Max mm			
245	14÷70	25,00	1	014970195

1497TE

Zange zum Lösen von elektrischen Steckverbindern

Äußerst schmale Backen zum Lösen der Clips, ohne die Steckverbinder zu beschädigen



L	A	Ø	€	Stk	Art-Nr	
mm	Max mm	mm				
1497TE	215	63	4	28,00	1	014970180

1497/C23

Werkzeugsortiment, 23teilig, für Entriegelung elektrische Steckverbinder



1497/C23	€	Stk	Art-Nr
	267,00	1	014970200

440x250x70 mm - 1,7 kg

1497/C94

Steckverbindersortiment, 94teilig, für Tests an Fahrzeugen

verwendbar für die wichtigsten Diagnosegeräte

- 2 Kabelschnellverbinder
- 2 Potentiometer
- 2 Kontrollleuchten
- 2 Steckverbinder SRS
- 2 Krokodilzangen
- 2 Nadelsonden
- 2 Prüfspitzen
- 2 Doppelbananenstecker
- 4 Einzelbananenstecker
- 24 flache Stecker 0.6+6 mm
- 12 runde Stecker 1.6+3.9 mm
- 24 flache Stekhülsen 0.6+6 mm
- 12 runde Stekhülsen 1.6+3.9 mm



1497/C94	€	Stk	Art-Nr
	471,00	1	014970300

430x390x100 mm - 3 kg

1497RC

Klemmprüfspitzen, Paar

- Kabelquerschnitt: 1,5÷3,5 mm
- Spannung: 0÷330V
- Max. Stromstärke: 5A



1497RC	€	Stk	Art-Nr
	89,50	1	014970351

1497KB/S3

Kit 3 Werkzeuge zum Entfernen der elektrischen Steckverbinder Knorr und Bremse

- 1 Werkzeug für Bajonett-Steckverbinder
- 1 Werkzeug mit Profil für 2-polige Steckverbinder
- 1 Werkzeug mit Doppelprofil für 4-, 6- oder 12-polige Steckverbinder



1497KB/S3	€	Stk	Art-Nr
	98,00	1	014970050

1497/S3

Litzensatz zur Elektrosignalerkennung, 3-teilig

- 1 Stck. gerade
- 1 Stck. 45°
- 1 Stck. 90°



1497/S3	€	Stk	Art-Nr
	22,20	1	014970400

1498

Spannungsprüfer

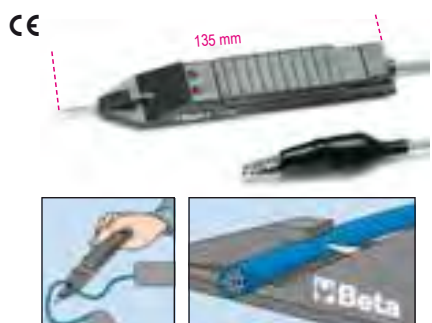

3÷48V	€	Stk	Art-Nr
	59,00	2	014980100



KFZ-SPEZIAL

Unsere Kfz-Spezialwerkzeuge, die von den anspruchsvollsten Professionisten verwendet werden, wurden entwickelt und ausgelegt, um die höchsten Weltstandards zu erfüllen. Sie werden kontinuierlich unter schwersten Nutzungsbedingungen getestet. Seit mehr als 50 Jahren sind wir mit Stolz Seite an Seite mit den großen Meistern, die uns dabei helfen, unsere Produkte ständig zu verbessern, und die unsere absolut hohe Qualität bestätigen.

Die Kfz-Spezialwerkzeuge finden Sie in diesen Abschnitten:

Diagnostik	von 1438 bis 1499 von 1758VT bis 1760TMC
Motor	von 955 bis 989A von 1438 bis 1499
Öl und Filter	von 1438 bis 1499 von 1877 bis 1885
Electric system	von 1438 bis 1499
Anlasser	von 1498BC/12 bis 1498/40A
Getriebe	von 1438 bis 1499
Radaufhängungen	von 1549 bis 1569CP
Bremsen	von 1438 bis 1499
Bereifung	von 955 bis 989A
Karosserie	von 1302 bis 1369 von 1763 bis 1767A
Weitere Einrichtungen	von 1875LT bis 3067
Heben	von 3029/2T bis 3067/70-13T



1498BC/12

Multifunktions-Startgerät, 12V, tragbar

Technische Daten:

- Starthilfestrom: 600A
- Anlasserspitzenstrom: 1500A
- Batterietyp: 4 Zellen LifePo4
- Batteriekapazität: 25000mAh
- Schutzgerät gegen Polaritätswechsel, Kurzschluss, Überstrom, Überlast und Überhitzung



CE

Standardzubehör:

- Schutzhülle
- Kabel mit Starterklemmen
- USB-Anschlüsse zur Aufladung elektronischer Geräte
- LED-Batterieladezustandsanzeige
- USB- und USB-C-Kabel
- Netzteil
- Multifunktions-LED-Lampe

	L	P	H	€		
	mm	mm	mm			
1498BC/12	225	100	40	392,00	1	014980040

1498MN/12-C

Starthilfekabel mit Zangen für Art. 1498BC/12



	€		
1498MN/12-C	70,00	1	014980005

1498MN/12-R

Netzteil Mini-Anlasser 1498BC/12



	€		
1498MN/12-R	51,50	1	014980003

1498MN/12-P

Netzteil Stecker für Auto Mini-Anlasser 1498BC/12



	€		
1498MN/12-P	31,50	1	014980004

1498MN/12-U

USB-Kabel mit Mehrzweck-U-Adaptern



	€		
1498MN/12-U	22,70	1	014980009

1498LT/12

Hochleistungsfähiger, ultraleichter Anlasser, tragbar



CE

Der Mikroprozessor ermöglicht den totalen Schutz gegen:

- Polaritätsumkehrung
- Kurzschluss
- falsche Spannung
- Überlast
- Unterlast
- Überentladung
- Übertemperatur

TECHNISCHE DATEN

Nutzspannung: 12 V
Dauerstrom: 800 A
Max. Anlassstrom: 2000 A
Spitzenstrom: 4000 A
Kabellänge: 500 mm
Batterietyp: 4 Zellen LifePo4
Funktion Speichersicherung: JA
Abmessungen: 260 x 135 x 72 mm
Nettogewicht: 2,5 kg
Ausgerüstet mit Ladeneinheit 12 V 1,3A

	€		
1498LT/12	996,00	1	014980012

1498LT/12-SF

Wandbefestigungsbügel für Anlasser Art. 1498LT/12



	€		
1498LT/12-SF	166,00	1	014980013

1498LT/12-R7

Netzteil für Anlasser Art. 1498LT/12



	€		
1498LT/12-R7	72,00	1	014980057

1498LT/12-24

Hochleistungsfähiger, ultraleichter Anlasser, 12-24 V, tragbar

geeignet für die Anwendung an PKWs, Nutzfahrzeugen und LKWs



Der Mikroprozessor ermöglicht den totalen Schutz gegen:

- Polaritätsumkehrung
 - Kurzschluss
 - falsche Spannung
 - Überlastung
 - Unterentladung
 - Überladung
 - Übertemperatur
- TECHNISCHE DATEN
- Nutzspeisung: 12/24V
 - Dauerstrom: 2000/1000 A
 - Max. Anlassstrom: 5000/2500 A
 - Spitzenstrom: 10000/5000 A
 - Klemmenstrom: 1000 A
 - Kabellänge: 160 cm
 - Kabelquerschnitt: 25 mm²
 - Automatische Ladevorrichtung: 4 Amp
 - Funktion Speichersicherung:
 - Abmessungen: 350x240x140 mm
 - Gewicht: 5 kg

1498LT/12-24 € 1.980,00 1 014980014

1498/12

PKW-Anlasser 12 V, tragbar



- TECHNISCHE MERKMALE:
- Anlassspitzenstrom 2200A
 - Schulterriemen
 - Hermetisch dichte Bleibatterie mit festgelegtem Elektrolyten (AGM)

1498/12 € 832,00 1 014980480

13 kg

1498/24

PKW- und Nutzfahrzeug-Anlasser 12-24 V, tragbar



TECHNISCHE MERKMALE:

- Anlassspitzenstrom 4200A (12V) - 2100A (24V)
- Schulterriemen
- Hermetisch dichte Bleibatterie mit festgelegtem Elektrolyten (AGM)

1498/24 € 1.670,00 1 014980490

1498B12/R02

Ersatzbatterie, 12V, für Anlasser Art. 1498B/12 und Art. 1498B/24



1498B12-R02 € 362,00 1 014980502

1498/12-24 R20

Netzteil für Anlasser Art. 1498/12 und Art. 1498/24



1498/12-24 R20 € 87,00 1 014980520

1498/2A

Elektronisches Batterieladegerät 12V für Motorräder

Ermöglicht das Aufladen aller Batterietypen Pb Wet, Agm, Gel, Mf, Vrla und Lithiumbatterien LiFePo4



- zwei spezifische Ladevorgänge für Lithium- und Bleibatterien
- automatischer mehrphasiger Ladezyklus
- Schutz gegen Polaritätsumkehrung und Kurzschluss
- Schutzgrad IP65
- enthält Kabel mit Klemmen und Kabel mit Ösen
- Versorgungsspeisung: 220-240V

TECHNISCHE DATEN

- Ladestrom: 1A
- Ladekapazität: 2Ah-40Ah
- Frequenz: 50-60 Hz
- Batteriespeisung: 12V
- Abmessungen: 180x80x40 mm
- Gewicht: 0,5 kg

1498/2A € 155,00 1 014980102

1498/4A

Elektronisches Auto-/Motorrad-Batterieladegerät, 6-12 V



- Schutz vor Polaritätswechsel und Kurzschlüssen
- Automatische Selektion zwischen 6 V und 12 V
- Automatische Selektion des Batterietyps
- Digitales, hintergrundbeleuchtetes Display
- Aufklappbare Befestigungskappe

TECHNISCHE DATEN

- Stromversorgung: 220V-240V
- Frequenz: 50-60 Hz
- Nennstrom (min-max): 1-4 Amp
- Batteriespeisung: 6V/12V
- Batteriekapazität: 4Ah-80Ah
- Ladezeit: 12 Stunden
- Schutzniveau: IP65

1498/4A € 187,00 1 014980104

1498SA/2A-4A

Kabel mit Zigarettenanzünderstecker für Art. 1498/2A und Art. 1498/4A



1498SA/2A-4A € 39,00 1 014980120



1498/8A

Elektronisches PKW-/Nutzfahrzeug-Batterieladegerät, 12 V



- Langsames und schnelles Laden (2A-8A)
- Erhaltungsladung
- Stromversorgungsfunktion 13,8V-5A
- Schutz vor Polaritätswechsel und Kurzschlüssen
- Manuelle Selektion des Batterietyps
- Digitales, hintergrundbeleuchtetes Display
- Aufklappbare Befestigungsspanne

TECHNISCHE DATEN

Stromversorgung: 220V - 240V
 Frequenz: 50-60 Hz
 Nennstrom (min-max): 2-8 Amp
 Batteriespannung: 12V
 Batteriekapazität: 5Ah-160Ah
 Speicherfunktion: 13,8V - 5A
 Schutzniveau: IP65

1498/8A € 264,00 1 014980108

1498/4A-8A CO

Ösenkabel für Art. 1498/4A und Art. 1498/8A



1498/4A-8A-CO € 18,90 1 014980114

1498/4A-8A CP

Kabel mit Klemmen für Art. 1498/4A und Art. 1498/8A



1498/4A-8A-CP € 24,30 1 014980118

1498/2A-8A-PR

Verlängerung für Art. 1498/2A/4A/8A



1498/2A-8A-PR € 45,00 1 014980119

1498/16A

Elektronisches Multifunktions-Batterieladegerät 12-24V



- Hintergrundbeleuchtetes Display
- Max. Dauerladestrom 16A
- Laden und Erhaltungsladen
- Schutz vor Polaritätswechseln und Kurzschlüssen
- 9 Aufladephasen
- Floating System
- Funktion SHOW ROOM (13,8V - 12A)
- Funktion SUPPLY (14V - 12A)
- Funktion Memory Saver (13,8V - 12A)
- Batterie Recovery-Funktion
- Klemmenhalter
- Befestigungshaken, zurückklappbar
- Einschließlich Zubehör: Kabel mit Klemmen, Ösenkabel

TECHNISCHE DATEN

Spannungsversorgung: 220-240V
 Leistung: 240W
 Ladestrom: 4-16A
 Batterientyp: Agm - Wet - Lithium (LiFePo4)
 Ladekapazität: 5-360Ah
 Erhaltungskapazität: 5-550Ah
 Ausgangsspannung: 12-24V
 Batterie Mindestspannung: 0,8V
 Schutzgrad: IP20

1498/16A € 554,00 1 014980126

1498/25A

Elektronisches Multifunktions-Batterieladegerät, 12-24V



Eigenschaften:

- Hintergrundbeleuchtetes Display
- Max. Dauerladestrom: 25A
- Laden und Erhaltungsladen
- Schutz vor Polaritätswechseln und Kurzschlüssen
- 9 Aufladephasen
- Floating System
- Funktion SHOW ROOM (13,8V - 21A)
- Funktion SUPPLY (14V - 21A)
- Funktion Memory Saver (13,8V - 21A)
- Batterie-Recovery-Funktion
- Klemmenhalter
- Befestigungshaken, zurückklappbar
- Einschließlich Zubehör: Kabel mit Klemmen

Technische Daten:

- Spannungsversorgung: 220-240V
- Leistung: 390W
- Ladestrom: 5-25A
- Batterientyp: Agm - Wet - Lithium (LiFePo4)
- Ladekapazität: 5-550Ah
- Erhaltungskapazität: 5-800Ah
- Ausgangsspannung: 12-24V
- Batterie Mindestspannung: 0,8V
- Schutzgrad: IP20

1498/25A L mm H mm P mm € 652,00 1 014980125



1498/120A

Elektronisches Multifunktions-Batterieladegerät, 12V

Ermöglicht das Laden der Batterien und versorgt die Fahrzeuge während allen Neuprogrammierungsphasen und Eigendiagnosevorgängen mit Strom



- Maximaler Dauerladestrom 120A
- Laden und Erhaltungsladen mit CPU Mikroprozessor
- Batterie Recovery-Funktion
- Neuprogrammierung Spannungsversorgung ECU
- Schutz vor Polaritätsumkehrung, Kurzschluss, falscher Voltspannung und Überlast

TECHNISCHE DATEN

Stromversorgung: 90-260V
 Leistung: 1500W
 Ladestrom: 10-120A
 Batterie-Typen: Agm - Wet - Lithium (LifePo4)
 Ladekapazität: 10-1200Ah
 Erhaltungskapazität: 5-3600Ah
 Ausgangsspannung: 12 Volt
 Länge Klemmenkabel: 2700 mm
 Abmessungen: 310 x 150 x 350 mm
 Gewicht: 8,5 kg

1498/120A € 3.440,00 1 014980142

1498/40A

Multifunktions-Start- und Batterieladegerät, 12-24 V auf Rädern

Da das Gerät keine interne Batterie hat, ersetzt die Startfunktion (max. 350A) nicht die Funktion eines spezifischen Anlagers Typ 1498LT/12 (2000A).



- 3 programmierte Ladezyklen sowie 1 manueller Zyklus
- Elektronischer Justierpotentiometer
- spezifische WET-SPIRAL/GEL-AGM Ladezyklen
- Elektronisches Steuer- und Schutzsystem
- 10-Stufen Ladeprozess
- Batterie Desulfurierung und Erhaltungsladung
- Supply-Funktion
- Doppelspannung 12-24 V
- Auch geeignet für Start&Stop-Batterien
- Professionelle gummiisolierte Messingklemmen

TECHNISCHE DATEN

Stromversorgung: 230 V
 Starthilfespannung: 12-24 V
 Ladestrom: 1-40 A
 Startstrom: 350A max cc
 Ladekapazität: 4-450Ah

1498/40A € 1.400,00 1 014980140

1498SM

Speicherschoner 12 V

Vermeidet den Verlust der durch den PKW-Computer gespeicherten Daten während Instandhaltungsarbeiten oder des Batteriewechsels.



Technische Merkmale:

- selbstversorgt
- Interne Batterie Pb 5 Ah
- 12 Volt
- Professioneller Anschluss mit OBD Stecker

1498SM € 299,00 1 014980020

1498SM-C

KFZ-Speicherkabel OBD II 12V für Art. 1498SM/C



1498SM-C € 88,50 1 014980021

1498SM-CP

KFZ-Speicherkabel Zange 12V Art. 1498SM/CP



1498SM-CP € 30,00 1 014980022

1498SM-A

Netzteil Speicherschoner Art. 1498SM/A



1498SM-A € 33,50 1 014980023

1498TB/6-12

Analoger Batterietester, 6-12V

Ermöglicht die Prüfung von 6V- und 12V-Batterien bis zu 1000CCA



Kabellänge: 500 mm

1498TB/6-12 L 290 mm L1 170 mm P 75 mm € 69,00 1 014980420



1498TB/12-24

Digitaler Tester für 12V-Batterien und Prüfgerät Start- und Ladesystem 12-24V

- Ermöglicht die Durchführung der folgenden Tests: Batterie, Generator (intelligent und normal) und Starter, Diode Restwelligkeit und Erdungstest
- Ausgestattet mit Software zum Drucken des durchgeführten Tests über PC
- Hintergrundbeleuchtetes Display
- Kompakte und stoßfeste Struktur
- Software in 10 Sprachen
- Ausgerüstet mit einem speziellen Eingang für den Anschluss eines entnehmbaren Mini-Druckers (Optionales Zubehör Beta 1498ST/TB)



CE

TECHNISCHE DATEN:

- Anwendungen: Batterietest 12V - Generatorladetest 12-24V Ladetest - Anlassersystemtest
- Betriebsintervall: 100-2000 CCA
- Bezugsnormen: CCA,SAE,DIN,EN,IEC,JIS
- Unterstützte Batterien: PB, WET, GEL, AGM, AGM FLAT, EFB
- Voltmeter: 9V-36V
- Kabellänge: 1600 mm
- Sprachen: Italienisch, Englisch, Französisch, Deutsch, Spanisch, Polnisch, Rumänisch, Holländisch, Schwedisch und Finnisch
- Inkl. Zubehör: USB-Kabel und Software

1498TB/12-24 € 798,00 1 014980401

1498ST/TB

Mini-Thermodrucker für Tester Art. 1498TB/12

- Möglicher Anschluss des Mini-Druckers direkt am Tester
- Ermöglicht das Ausdrucken der Testergebnisse



CE

1498ST/TB € 286,00 1 014980410

1498ST/TB ROT

Ersatzpapier für Drucker Art. 1498ST/TB



1498ST/TB ROT € 13,90 2 014980411

1498PC

Spannungsregler 12-24 V

Unverzichtbar zum Schutz der Steuergeräte beim Schweißen und Anlassen mit Anlassern



1498PC € 119,00 1 014980801

1499

Autoskop



1499 € 120,00 1 014990001

1500/...

Universal-Abzieher mit zwei Armen



	L mm	€		
1500/1	100	101,00	1	015000301
1500/2	100	105,00	1	015000302
1500/3	150	174,00	1	015000303
1500/4	150	239,00	1	015000304
1500/5	205	434,00	1	015000305
1500/6	205	508,00	1	015000306
1500/7	205	761,00	1	015000307
1500/8	230	1.220,00	1	015000308

	A min÷Max mm	A1 min÷Max mm
1500/1	25÷80	70÷130
1500/2	25÷130	80÷180
1500/3	50÷160	105÷220
1500/4	60÷200	120÷270
1500/5	80÷250	160÷330
1500/6	80÷350	160÷420
1500/7	110÷520	195÷600
1500/8	170÷640	260÷715

Beta



1500/SP5 € 1.122,00 1 015000325
 1500/1-1500/2-1500/3
 1500/4-1500/5
 1500/SPV € 97,50 1 015000001

1500G/...

Abzieharme, 1 Paar, normale Ausführung, für Abzieher Art. 1500 und 1580/8I



	mm	1500	€		
1500G/1	35	/1-2	64,00	1	015000311
1500G/3	35	/3-4	95,00	1	015000313
1500G/5	35	/5-6-7	193,00	1	015000315
1500G/8	50	/8	237,00	1	015000317

1580/8I

1500N/...

Universal-Abzieher mit 2 Gleitarmen

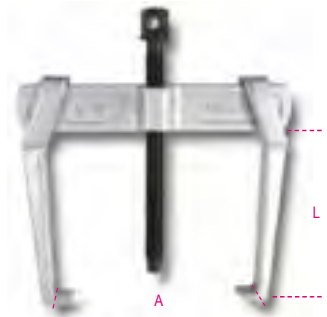

	A min÷Max mm	L mm	€		
1500N0	18÷65	70	89,50	1	015000600
1500N1	23÷70	100	93,00	1	015000601
1500N2	23÷100	100	102,00	1	015000602
1500N3	35÷140	150	169,00	1	015000603
1500N4	35÷190	150	181,00	1	015000604
1500N5	43÷250	205	349,00	1	015000605
1500N6	43÷320	205	378,00	1	015000606



	€		
1500N/SP6	982,00	1	015000626
1500N/0-1500N/1-1500N/2-1500N/3			
1500N/4-1500N/5			
1500N/SPV	119,00	1	015000006

1500N/G...

Abzieharme für Abzieher Art. 1500N



	mm	1500N	€		
1500N/G0	10	/0	29,50	2	015000650
1500N/G1-2	12	/1-2	32,00	2	015000651
1500N/G3-4	17	/3-4	55,50	2	015000653
1500N/G5-6	23	/5-6	110,00	2	015000655

1501/1 - 2 - 3

Abzieher mit zwei dünnen Armen

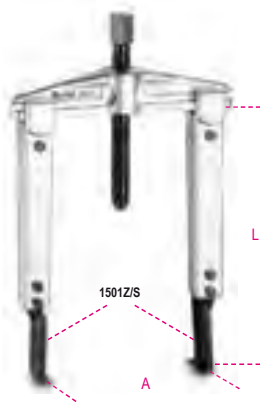

	L mm	€		
1501/1	100	225,00	1	015010101
1501/2	200	239,00	1	015010102
1501/3	250	251,00	1	015010103

	A min+Max mm
1501/1	25÷130
1501/2	25÷130
1501/3	25÷130



1501G/1 - 2 - 3

Arme für Art. 1501

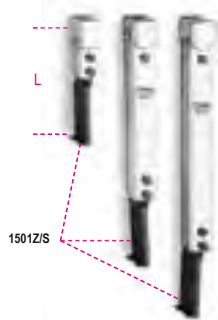

	L mm	€		
1501G/1	100	125,00	1	015010111
1501G/2	200	145,00	1	015010112
1501G/3	250	157,00	1	015010113

1501Z/S - P - R

Endstücke für Arme 1501G



	mm	D mm	€		
1501Z/S	2,0	27	44,50	2	015010211
1501Z/P	3,6	27	45,00	2	015010212
1501Z/R	3,6	14	51,00	2	015010213

1502/...

Zweiarmlige Universalabzieher mit schneller Armeinstellung und -spannung

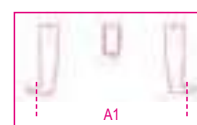

	L mm	L1 mm	€		
1502/0	100	166	149,00	1	015020000
1502/1	100	166	161,00	1	015020001
1502/2	150	247	255,00	1	015020002
1502/3	150	247	283,00	1	015020003
1502/4	200	321	485,00	1	015020004

	A min+Max mm	A1 min+Max mm
1502/0	40÷90	80÷130
1502/1	50÷130	90÷170
1502/2	65÷150	115÷210
1502/3	65÷190	125÷260
1502/4	70÷235	170÷335

1505V

Abzieher für Front- und Heckscheibenwischer

Spitze aus gelochtem Messing, abnehmbar, zum Abziehen von Wischarmen mit integrierter Scheibenwaschdüse



	A Max mm	L mm	€		
1505V	43	37	52,00	1	015050001

1505/C5

Windschutzscheiben-Abzieher-Satz

1 Abzieher mit 2 Armen Ø 25÷40 mm
4 Schneidmesser Ø 25 mm, Ø 30 mm, Ø 35 mm, Ø 41 mm



mm 12 € 175,00 1 015050300

320x150x60 mm - 1,2 kg

1506

Selbstspannender Abzieher mit zwei Armen

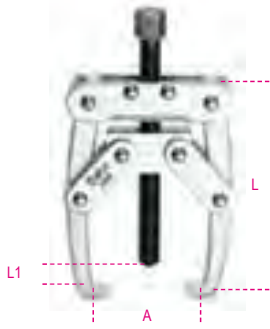

A	L	L1	€	1	015060001
min÷Max	mm	mm			
10÷50	80	40	53,50	1	015060001

1508/1 - 1508/2

Abzieher mit zwei Armen, leichte Ausführung



L	€	1	015080001
mm			
1508/1	180,00	1	015080001
1508/2	214,00	1	015080002

A	L1
min÷Max	mm
6÷100	85
10÷140	120

1511/1 - 2 - 3

Außenabzieher mit zwei umkehrbaren Armen

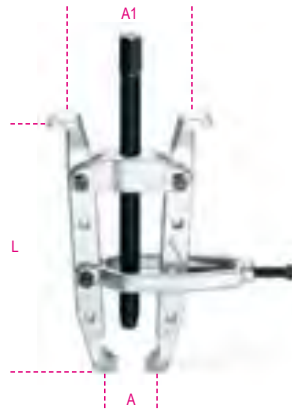

L	€	1	015110001
mm			
1511/1	304,00	1	015110001
1511/2	380,00	1	015110002
1511/3	472,00	1	015110003

A	A1
min÷Max	min÷Max
mm	mm
1511/1	65÷95
1511/2	103÷190
1511/3	103÷175

1515/1 - 2 - 3

Abzieher mit zwei schwenkbaren Armen

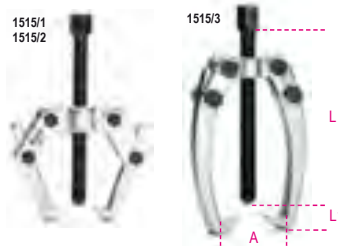

L	€	1	015150101
mm			
1515/1	39,50	1	015150101
1515/2	42,00	1	015150102
1515/3	63,00	1	015150103

A	L1
Max	mm
1515/1	105
1515/2	105
1515/3	105

1516/1 - 2 - 3

Abzieher mit drei schwenkbaren Armen



L	€	1	015160001
mm			
1516/1	57,50	1	015160001
1516/2	61,50	1	015160002
1516/3	87,00	1	015160003

A	L1
Max	mm
1516/1	85
1516/2	85
1516/3	105

1517

Abzieher mit 3 selbstspannenden Armen

- Für hohe Abziehlasten.
- Selbstspannend.

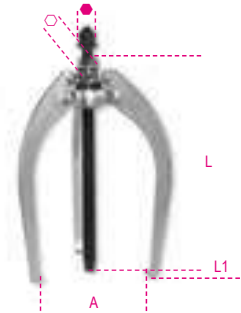

L	L1	Ø	€	1	015170000
mm	mm	mm			
1517/90	182	60	312,00	1	015170000
1517/150	242	115	320,00	1	015170010
1517/200	307	150	369,00	1	015170020
1517/260	395	180	428,00	1	015170030

●	A	kg	N
mm	mm		
1517/90	18÷90	6000	59000
1517/150	25÷150	6000	59000
1517/200	40÷200	6000	59000
1517/260	50÷260	8000	78500



1517C SELBSTSPANNENDE AUSSENABZIEHER MIT 2 ODER 3 ARMEN

Der Abzieher Beta 1517C arbeitet mit automatischer Spannung der Arme dank der an der Traverse befindlichen Feder. Diese Eigenschaft erleichtert die Positionierung und die Blockierung des Abziehers am abzuziehenden Teil. Nach erfolgter Positionierung können die Arme mittels der Mutter blockiert werden.

Die besondere Traverse am Abzieher 1517C hat 4 Aufnahmen, durch die der Abzieher sowohl mit 2 Armen - für ein einfacheres und schnelleres Arbeiten -, als auch mit 3 Armen - mit einer höheren Arbeitsstabilität - verwendet werden kann.

Der Sicherheitsstift am Kopf der Schraube bricht, wenn das maximal zulässige Anziehmoment überschritten wird, und schützt so den Abzieher vor Überlastungen.



1517C/...

Zwei- oder dreiarmlige Kombi-Abzieher, selbstspannend

- Kann sowohl 2-armig wie 3-armig verwendet werden.
- Selbst-spannend.



	L mm	L1 mm	€		
1517C/0	145	250	264,00	1	015170500
1517C/1	200	300	324,00	1	015170501
1517C/2	270	300	402,00	1	015170502

	A mm	● mm
1517C/0	12÷140	18
1517C/1	20÷180	18
1517C/2	30÷280	18

1518/...

Abzieher mit drei Armen



	L mm	€		
1518/1	105	96,50	1	015180001
1518/2	135	124,00	1	015180002
1518/3	235	219,00	1	015180003
1518/4	270	326,00	1	015180004
1518/5	270	382,00	1	015180005
1518/6	270	400,00	1	015180006

	A min+Max mm	L1 mm
1518/1	24÷100	105
1518/2	32÷160	150
1518/3	40÷220	220
1518/4	80÷250	240
1518/5	80÷300	350
1518/6	80÷350	400



1518U/...

Dreiarmlige Universalabzieher

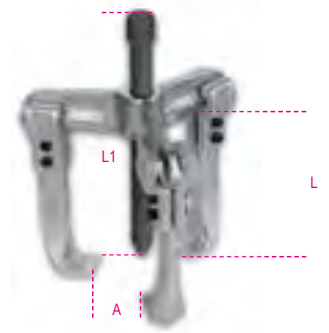

	L mm	L1 mm	€		
1518U/0	100	166	183,00	1	015180500
1518U/1	100	166	195,00	1	015180501
1518U/2	150	247	296,00	1	015180502
1518U/3	150	247	310,00	1	015180503
1518U/4	200	321	447,00	1	015180504

	A min+Max mm	A1 min+Max mm	● mm
1518U/0	40÷90	80÷130	17
1518U/1	50÷130	90÷170	17
1518U/2	65÷150	115÷210	22
1518U/3	65÷190	125÷260	22
1518U/4	70÷235	170÷335	27

1519/...

Dreiarmlige Universalabzieher mit schneller Armeinstellung und -spannung

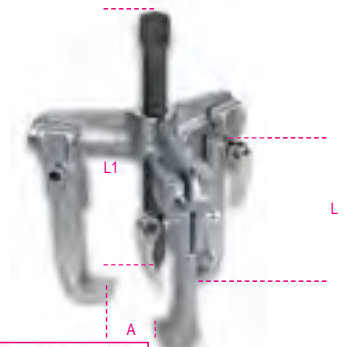

	L mm	L1 mm	€		
1519/0	100	166	210,00	1	015190000
1519/1	100	166	223,00	1	015190001
1519/2	150	247	319,00	1	015190002
1519/3	150	247	338,00	1	015190003

	A min+Max mm	A1 min+Max mm	● mm
1519/0	40÷90	80÷130	17
1519/1	50÷130	90÷170	17
1519/2	65÷150	115÷210	22
1519/3	65÷190	125÷260	22

1520/1 - 1520/2

Abzieher mit zwei umkehrbaren Armen



	L mm	€	🔧	📦
1520/1	135	91,50	1	015200101
1520/2	235	157,00	1	015200102

	A Max mm	L1 mm
1520/1	110	85
1520/2	160	140

1521/1 - 1521/2

Abzieher mit drei umkehrbaren Armen

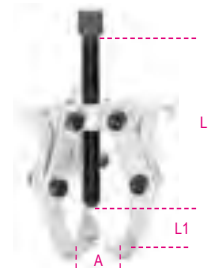

	L mm	€	🔧	📦
1521/1	135	119,00	1	015210101
1521/2	235	209,00	1	015210102

	A Max mm	L1 mm
1521/1	110	90
1521/2	160	140

1528

Selbstspannender Abzieher für Bremscheiben



∅ 19 mm

	A min+Max mm	€	🔧	📦
	170÷ 380	212,00	1	015280000

📏 480x240x60 mm - 🏠 4,8 kg

1529

Abzieher für mehrfach gerillte Riemenscheiben



A	L	L1	€	🔧	📦
min+Max mm	min+Max mm	min+Max mm			
24÷240	60÷95	90÷135	310,00	1	015290000

📏 260x210x60 mm - 🏠 2,6 kg

1529/C7

Abzieher für Riemenscheiben

Der Kit umfasst:

- 2 Klauen mit Doppelfuss 4,7 mm
- 2 Klauen mit Einzelfuss 4,3 mm
- 1 Klaue mit Doppelfuss 2,3 mm
- 1 Klaue mit Einzelfuss 2,3 mm

Das Klauenpaar ist je nach Arbeitsanforderungen zusammensetzbar



	L	L1	A	€	🔧	📦
	mm	mm	min+Max mm			
1529/C7	50	72,5	53÷114	181,00	1	015290100

📏 285x155x50 mm - 🏠 2 kg

1529PI

Universal-Abzieher für Einspritzpumpen-Riemenscheibe

- Ermöglicht einen schnellen und präzisen Ausbau der Kraftstoffspritzpumpen-Riemenscheibe.
- Besonders geeignet für Fiat, Ford, Volkswagen, Citroën und Peugeot

Beinhaltet zudem 3 Schraubenpaar zum Verschrauben des Abziehers an der Riemenscheibe:

- M6 x 1.0 x 49 mm
- M7 x 1.0 x 75 mm
- M8 x 1.25 x 76 mm



1529PI	130,00	1	015290051
--------	--------	---	-----------

1529/PG

Abzieher für Diesel-Hochdruckpumpe Fahrzeuge VAG-Gruppe

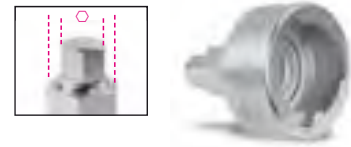

	∅ mm	€	🔧	📦
1529/PG	15-24	79,00	1	015290010

1530/C5

Werkzeugsatz für Radnaben und Radlager mit 3, 4, 5 Bohrungen

Der Werkzeugsatz umfasst:

- 1 Universalfansch 96÷138 mm
- 1 Hydraulikspindel 12 Tonnen
- 1 Schwungmasse von 2,8 kg, unbedingt erforderlich für Radnaben ohne Aufspannbolzen in der Mitte



1530/C5	652,00	1	015300300
---------	--------	---	-----------

📏 760x320x120 mm - 🏠 11,5 kg

1530/C16

Schwungmassekit mit Distanzsäulen, zum Abziehen von Radnaben und Radlagern mit 3, 4, 5 Bohrungen

Ideal für Naben mit hervorstehendem Zentrierung

Der Werkzeugsatz umfasst:

- 1 Universalfansch 90÷130 mm
- 1 Schwungmasse von 5 kg
- 4 Säulen Anschluss M12
- 4 Säulen Anschluss M14



1530/C16	801,00	1	015300316
----------	--------	---	-----------

📏 760x310x100 mm - 🏠 13,5 kg

1531/C7

Satz zum Entfernen des Innenrings
des Radlagers aus der Nabe

Abmessungen:

- 1 Zange Ø 40÷45 mm
- 1 Zange Ø 45÷51 mm
- 1 Zange Ø 50÷55 mm
- 1 Zange Ø 55÷61 mm



1531/C7 € 881,00 1 015310107

390x315x96 mm - 4,3 kg

1532

Dichtungswerkzeug



1532 € 20,50 2 015320001

1533/...

Abziehvorrichtung
für Trennvorrichtungen Art. 1534



	L mm	€		
1533/2	150	134,00	1	015330002
1533/3	210	253,00	1	015330003
1533/4	315	401,00	1	015330004
1533/5A	305	485,00	1	015330006

	A min÷Max mm	L1 mm
1533/2	45÷140	110
1533/3	55÷205	175
1533/4	90÷260	175
1533/5A	100÷360	235

1533PR/1 - 2 - 3

Verlängerungen
für Abziehvorrichtungen Art. 1533

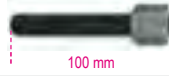

	€		
1533PR/1	28,50	1	015330011
1533/2			
1533PR/2	31,50	1	015330012
1533/3			
1533PR/3	33,00	1	015330013
1533/4			
1533PR/5A	33,00	1	015330016
1533/5A			

1534/...

Trennvorrichtungen

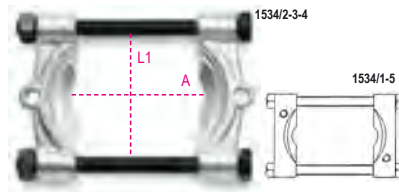

		€		
1534/1	1533/2	116,00	1	015340001
1534/2	1533/2	137,00	1	015340002
1534/3	1533/3	228,00	1	015340003
1534/4	1533/4	382,00	1	015340004
1534/5A	1533/5A	787,00	1	015340006

	A min÷Max mm	L1 mm
1534/1	5÷60	63
1534/2	12÷75	75
1534/3	22÷115	118
1534/4	25÷155	154
1534/5A	30÷220	180

1535/C...

Abziehsortiment



1535/C1 € 371,00 1 015350001

	€		
1533/2			
1533PR/1			
1534/1			

260x180x40 mm - 2,5 kg

1535/C2 € 393,00 1 015350002

	€		
1533/2			
1533PR/1			
1534/2			

260x180x40 mm - 2,8 kg

1535/C3 € 644,00 1 015350003

	€		
1533/3			
1533PR/2			
1534/3			

380x280x55 mm - 8,0 kg

1535/C4 € 995,00 1 015350004

	€		
1533/4			
1533PR/3			
1534/4			

420x380x65 mm - 14,8 kg

1535/C5A € 1.510,00 1 015350006

530x510x85 mm - 27,2 kg

1539

Gleithammer für Bleche



1539 € 203,00 1 015390001

1540

Gleithammer

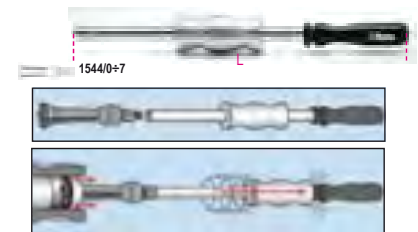

1540 € 114,00 1 015400001



1542/1 - 1542/2

Abziehvorrichtung für Abziehklemmen



	A	min+Max	1544	€		
	mm	mm				
1542/1	35÷75	0÷7		97,50	1	015420001
1542/2	60÷130	9C-10C		147,00	1	015420002

	L	L1
	mm	mm
1542/1	140	140
1542/2	175	160

1544/...

Innenabzieher

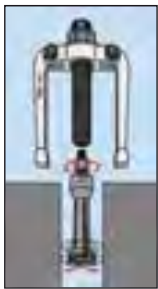

	C	mm	mm	€		
1544/0	0,25	M10		86,00	1	015440100
A= 5÷7						
1544/A	0,80	M10		89,50	1	015440105
A= 7÷9						
1544/1	0,80	M10		91,50	1	015440110
A= 9÷12						
1544/2	1,15	M10		94,00	1	015440120
A= 13÷17						
1544/2B	1,00	M10		96,00	1	015440121
A= 14÷19						
1544/3	1,70	M10		98,50	1	015440130
A= 16÷21						
1544/4	1,65	M10		110,00	1	015440140
A= 20÷25						
1544/5	2,00	M10		118,00	1	015440150
A= 25÷30						
1544/6	3,00	M10		147,00	1	015440160
A= 30÷37						
1544/7	3,80	M10		167,00	1	015440170
A= 38÷45						
1544/9C	2,60	G 3/8"		242,00	1	015440189
A= 40÷75						
1544/10C	7,30	G 3/8"		333,00	1	015440199
A= 70÷115						

1545/C5M

Abziehvorrichtung 1542/1
mit 5 Innenabziehern 1544



1545/C5M	€		
	661,00	1	015450011

1542/1	● 24 mm
1544/1	9÷12 mm
1544/2	13÷17 mm
1544/3	16÷21 mm
1544/4	20÷25 mm
1544/5	25÷30 mm

≡ 265x180x45 mm - 2,4 kg

1547/C6

Abzieher für Kugellager mit falschen Kugeln



1547/C6	€		
	336,00	1	015470006

≡ 420x185x60 mm - 3 kg

1547KP

Satz an Klemmenpaaren mit Blindkugel, 3teilig



	Ø	€		
	mm			
1547KP/1	9-11-12,5	53,00	1	015470106
1547KP/2	5-6-8	37,00	1	015470206

1547P

Sechskantverlängerungen



	L	mm	mm	€		
1547P/1	205	1547/1		11,60	1	015470101
1547P/2	102	1547/2		7,40	1	015470201

1547PC/2

Verlängerungen, rund und kurz



	L	mm	mm	€		
1547PC/2	42	1547/2		6,00	1	015470202

1547PL/2

Verlängerungen, rund und lang

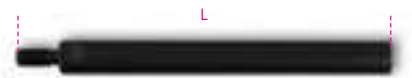

	L	mm	mm	€		
1547PL/2	106	1547/2		6,70	1	015470203

1549

Abzugsatz für doppelwirkende
Gas-Druck-Stoßdämpfer

Ermöglicht, den Ständer während des Einbaus der Federn
gespannt zu halten



1549	€		
	464,00	1	015490001

≡ 310x270x110 mm - 3 kg



1550U

Druckluft-Werkzeug zum Ausbau der Stoßdämpfer für Kraftfahrzeuge, SUV und leichte Nutzfahrzeuge

CE

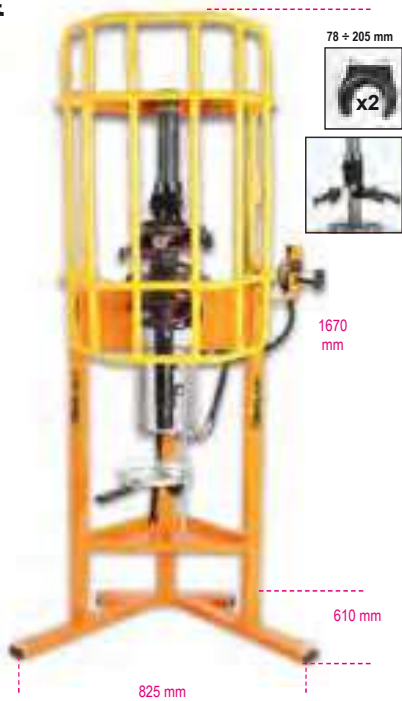

HÖHERE LEISTUNG: Max. Druckleistung 2 ton (10 bar)
OBERES UNIVERSAL-GREIFSYSTEM: Ermöglicht mit einer einzigen oberen anpassbaren Platte alle Federdurchmesser, sowohl mit Rechts- als auch Linkswicklung, zu komprimieren.
AKTIVES SICHERHEITSSYSTEM AUF FEDER: Durch den Sicherheitshaken und die 3 Sperrventile werden die korrekte Positionierung/Aufnahme der Feder und die Beibehaltung dieser Position für den ganzen Kompressionsvorgang gewährleistet. Bei "nicht konformer" Positionierung der Feder hält das System die Maschine an.
SCHUTZGITTER "FULL BODY": Garantiert die maximale Sicherheit und Abdeckung des Arbeitsbereichs
BETÄTIGUNG MIT BEDIENHEBEL: Höhere Präzision und Sensibilität während der Kompressionsphase
ARBEITSPPOSITION: Arbeitshöhe auf angehobenem Bügel hinten bis zu 875 mm

Ausgestattet mit 2 unteren Bügeln für Durchmesser 78-205 mm

TECHNISCHE DATEN

Druckleistung: 2 ton (10 bar) - 1.6 ton (8 bar) - 1.2 ton (6 bar)
 Kompressionsweg Feder: 335 mm

1550U € 3.530,00 1 015500010

1550U/CGS-R

Paar obere Backen tiefer gelegen für Art. 1550U



1550U/CGS-R € 680,00 1 015500035

1550U/MRC-ABE

Spezialbügel für Art. 1550U spezifisch für Mercedes Klasse A-B-E



1550U/MRC-ABE € 700,00 1 015500031

1550U/MRC-C

Spezialbügel für Art. 1550U spezifisch für Mercedes Klasse C



1550U/MRC-C € 615,00 1 015500032

1550U/S...

Unterer Bügel für Art. 1550U



	Ø mm	€		
1550U/S 130	78÷130 mm	446,00	1	015500014
1550U/S 182	105÷182 mm	446,00	1	015500015
1550U/S 205	125÷205 mm	446,00	1	015500016

1550U/SS187

Luftgängiger Bügel für Art. 1550U

Besonders geeignet für Federn mit Linkspröfil
 Typ Nissan Qashqai und Renault Koleos



1550U/SS 187 € 446,00 1 015500018

1550U/M

Spannstock für Ausbauwerkzeug Stoßdämpfer Art. 1550U

Ermöglicht die Blockierung des Stoßdämpferschafts



1550U/M € 424,00 1 015500021

1551/C20

Kit für Ausbau von Stoßdämpferköpfen

Kitinhalt:

- 7 Sechskant-Steckschlüssel, Maße: 16 - 17 - 18 - 19 - 21 - 22 - 24
- 1 Verlängerung Buchsenhalter Länge: 120 mm
- 3 Buchseneinsätze hohl, Maße: 8x5 - 8x6 - 11x8
- 1 Sechskantbuchseneinsatz Maß: 10 mm
- 1 Stifteinsatz XZN(R) Maß: M10
- 1 Stifteinsatz Torx(R) Maß: T50
- 4 Sechskantstifteinsätze Maße: 5-6 - 7 - 8
- 1 Verlängerung Einsatzhalter Länge: 95 mm
- 1 Verlängerung Einsatzhalter Länge: 190 mm



1551/C20 € 187,00 1 015510020

320x245x71 mm - 2,6 kg

1552/C9

Kit zum Spreizen der Stoßdämpferkupplungen, Schwenkarme und Lenkung

Es ist möglich mit Einzel- oder Doppelspreizkopf zu arbeiten, um auch an Doppelkupplungen der VAG Gruppe einzugreifen



1552/C9 € 149,00 1 015520020

195x140x40 mm - 1,0 kg



1555/Q

Federspanner für Mac-Pherson-Aufhängungen u.ä.

Druckkraft: 1500 kg

CE □ 1/2

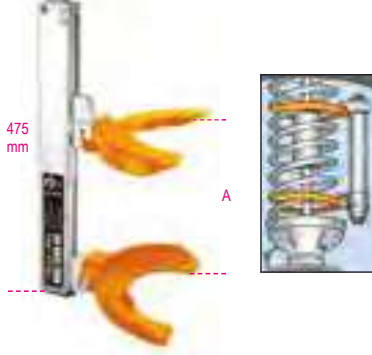

A	∅	€	1	015550006
min+Max mm	min+Max mm			
65÷354	80÷195	965,00		

1555/QS

Federspanner für Mac-Pherson-Aufhängungen u.ä.

CE □



A	∅	€	1	015550005
min+Max mm	min+Max mm			
70÷300	80÷200	1.189,00		

1555S/BMW-RNT

Schale für Stoßdämpfer BMW E39, E46 und Renault Mégane II für Art. 1555Q und Art. 1555/QS



1555S/BMW-RNT	€	1	015550303
	373,00		

1555C

Teleskop-Federspanner mit 4 Schalen und Torsionsstange

□ 1/2



A	∅	N	t	€	1	015550202
min+Max mm	min+Max mm					
80÷225	90÷160	25000	8,5	1.145,00		

1556/1A

Federspanner

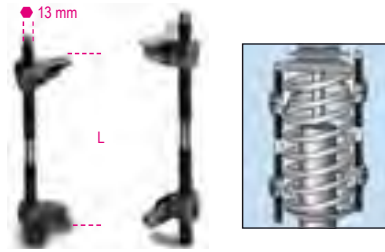

min L Max mm	€	1	015560101
65÷320	278,00		

1556/2A

Federspanner

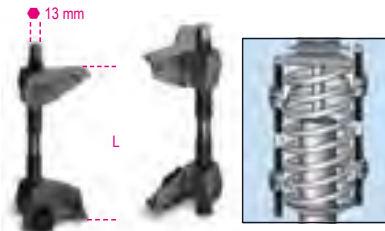

min L Max mm	€	1	015560102
65÷200	275,00		

1557

Kraftsteckschlüssel für Federbolzen Truck

□ 3/4



L mm	L1 mm	€	1	015570137
37	28	104,00		
46	34	106,00		
56	34	115,00		

1557V

Kraftsteckschlüssel für Federbolzen Truck Volvo



mm	€	1	015570299
27	53,50		

1557/S3

Satz mit 3 Nutmutterneinsätzen für Stoßdämpfer

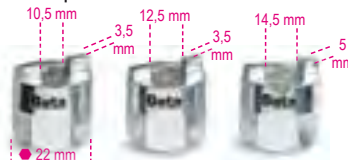

1557/S3	€	1	015570010
	80,50		

1558/C4

Werkzeug für Innen- und Außen-Seegerringe mit Schraubenantrieb

Durch den Vierkantantrieb wird bei beiden Betriebsbedingungen eine große Kraft ausgeübt.
Mitgelieferte Spitzen:
∅ 2,5-3-3,5 mm



1558/C4	∅ mm	∅ mm	€	1	015580100
	5,5 ÷ 77	5,5 ÷ 77	199,00		
330x220x50 mm - 900 g					

1558P

Paar Prüfspitzen Seeger Ringer für Art. 1558



∅ mm	€	1	015580125
2,5	10,10		
3,0	10,10		
3,5	10,10		

1558/C13

Werkzeug für Innen- und Außen-Seegerringe mit Schraubenantrieb

Durch den Vierkantantrieb wird bei beiden Betriebsbedingungen eine große Kraft ausgeübt.

Mitgelieferte Spitzen:
• gerade: ∅ 2,5 - 3 - 3,5 - 3,8 mm
• 45°: ∅ 2,5 - 3 - 3,5 - 3,8 mm
• 90°: ∅ 2,5 - 3 - 3,5 - 3,8 mm



1558/C13	∅ mm	∅ mm	€	1	015580200
	5,5 ÷ 77	5,5 ÷ 77	266,00		
330x220x45 mm - 1,6 kg					

1559

Kugelgelenkabzieher,
leichte Ausführung



	A Max mm	Ø mm	€		
1559/22	50	18÷22	103,00	1	015590001
1559/36	90	36	473,00	1	015590036
1559/45	115	45	709,00	1	015590045

1559V/8T

Hydraulische Schraube für Kugelgelenkabzieher
Art. 1559/36 und Art. 1559/45

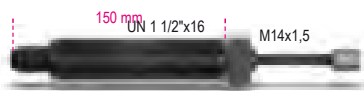

Nm	t	€		
80000	8	358,00	1	015590145

1560/2

Kugelgelenkabzieher, Profimodell



	A min+Max mm	Ø mm	€		
1560/2	60÷85	20	220,00	1	015600002

1560A

Kugelgelenkabzieher

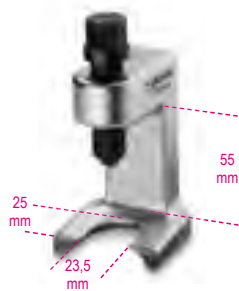

	€		
1560A	295,00	1	015600601

1561/...

Kugelgelenkabzieher



	L mm	A mm	Ø mm	€		
1561/1	39	36,6	18	80,00	1	015610001
1561/2	47	45,7	25	105,00	1	015610002
1561/3	63	62	30	152,00	1	015610003
1561/4	75	63	40	193,00	1	015610004

1562D

Kugelgelenkabzieher

Mit 2 Schrauben zum Abziehen von Federungs- oder Lenkradkupplungen



A max mm	Ø mm	• mm	L mm	€		
50	39	26	155	401,00	1	015620239

1563/C4

Steckschlüsselsatz, 4-teilig, zum Abziehen von Kugelgelenken

Zur Verwendung mit Meißelhammer

Satzinhalt:

- 1 Steckschlüssel M12x1,25 mm
- 1 Steckschlüssel M12x1,5 mm
- 1 Steckschlüssel M14x1,5 mm
- 1 Steckschlüssel M16x1,5 mm



22/24 mm

	€		
1563/C4	57,50	1	015630010

1565/1 - 2 - 3

Gleithammer für Kugelgelenke



	Ø mm	L1 mm	€		
1565/1	18	65	91,00	1	015650001
1565/2	23	65	103,00	1	015650002
1565/3	30	88	108,00	1	015650003

1566N

Werkzeug zum Ausbau/Einbau der Lenkerarme



Ø x L mm	○ mm	□	€		
28÷35 x 400	27	12	146,00	1	015660005
35÷45 x 190	27	-	146,00	1	015660008
35÷45 x 400	27	12	164,00	1	015660010

1566R

Werkzeug zum Ausbau/Einbau der Lenkerarme, verstellbar



Ø mm	€		
27÷43	28,00	1	015660015

1566/G01

Abzieher für Gleichaufgelenk

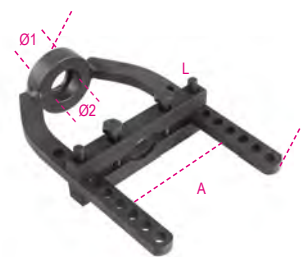

L mm	A mm	Ø1 mm	Ø2 mm	€		
250	115	29	36	174,00	1	015660052

1566P

Zange für Spannringe für geriffelte Antriebswellen

Die Zange komprimiert den Spannring und vereinfacht das Einfügen der Antriebswelle in das homokinische Gelenk



L mm	A Max mm	€		
280	36	78,50	1	015660091

1567

Hebel zum Ausbau von Querlenkern und Stoßdämpfern

Mühsame Positionierung des Hebels durch einen Bediener



A mm	B min+Max mm	€		
1060	100÷300	398,00	1	015670001

1568

Druckluftmontagegerät
für Achswellenmanschetten aus Silikon
8 Spreizerarme
Max. Armspreizung der Arme: 145 mm

CE



L mm	L1 mm	€	1	015680001
420	195	284,00	1	015680001

1569/F

Werkzeugsortiment zum Auszug und zur
Einführung der Silentblöcke für Fiat Panda, Fiat 500 und
Ford Ka



1569/F	€	1	015690021
	524,00	1	015690021

1569/SB

Werkzeugsortiment zum Auszug und zur
Einführung der Silentblöcke der Hinterachse,
Ölabdichtungen und Radlager

• Die Buchsen können sowohl direkt am Fahrzeug als auch an
der Hydraulikpresse angewendet werden



1569/SB	€	1	015690016
	294,00	1	015690016

425x365x100 mm - 13 kg

1569CP

Schlageinzieher
für Kugellager und Ölabdichtungen

Schnelleinstellung



	Ø min+Max mm	L mm	€	1	015690750
1569CP/50	9,5÷50	130	156,00	1	015690750
1569CP/90	18÷90	145	193,00	1	015690790

1570/3

Druckpressen für Abzieher

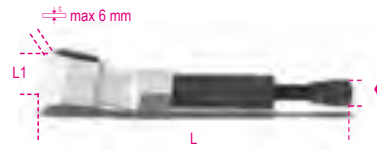

t	L mm	L1 mm	• mm	€	1	015700003
30	243	36	19	286,00	1	015700003

1580/8I

Universal-Abzieher mit drei Armen,
für hydraulische Betätigung

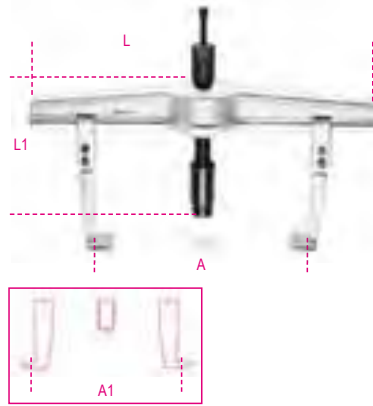

1580/8I	€	1	015800008
	1.835,00	1	015800008

	A min+Max mm	L mm	L1 mm	A1 min+Max mm	N Max
1580/8I	170÷640	715	280	260÷715	180000

1580GL

Abzieharne, lange Ausführung, für Abzieher
Art. 1580/8I



	L mm	€	1	015800227
1580GL/8A	300	207,00	1	015800227
1580GL/8B	400	230,00	1	015800228
1580GL/8C	500	294,00	1	015800229

1585/5I - 6I - 7I

Abzieher mit drei Armen,
für hydraulische Betätigung

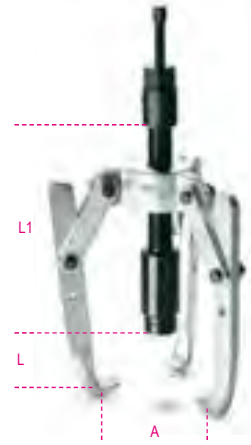

	€	1	015850005
1585/5I	1.275,00	1	015850005
1585/6I	1.340,00	1	015850006
1585/7I	1.380,00	1	015850007

	A min+Max mm	L1 mm	L mm	N Max
1585/5I	50÷350	135	280	150000
1585/6I	50÷350	235	280	150000
1585/7I	50÷350	335	280	150000

1585GI/5 - 6 - 7

Arme für hydraulische Abzieher
Art. 1585/5I-1585/6I-1585/7I

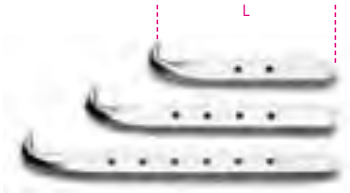

	L mm	€	1	015850205
1585GI/5	135	116,00	1	015850205
1585GI/6	235	137,00	1	015850206
1585GI/7	335	166,00	1	015850207

1589VI

Hydraulische Spindel für Art. 1580/8I
und 1585/5I-1585/6I-1585/7I

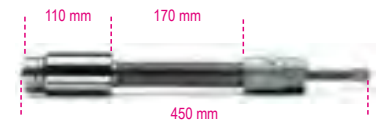

1589VI	€	1	015890001
	751,00	1	015890001

1589PI/50 - 100 - 150

Verlängerungen
für hydraulische Spindeln



	L mm	L1 mm	€	1	015890005
1589PI/50	50	70	68,00	1	015890005
1589PI/100	100	120	75,00	1	015890010
1589PI/150	150	170	81,50	1	015890015

1590 C-Schraubzwingen



A max mm	L1 mm	€	Hand	Computer
60	55	31,50	2	015900305
100	65	50,00	2	015900310
150	95	83,00	2	015900315

1591 Schraubzwingen



A	A max mm	L1 mm	€	Hand	Computer
200	200	80	33,00	2	015910020
300	310	85	40,00	2	015910030
400	410	85	44,00	2	015910040
500	500	95	58,50	2	015910050
600	600	95	59,50	2	015910060
800	800	95	72,50	2	015910080
1000	1000	110	91,00	2	015910100

1593 Schraubzwingen

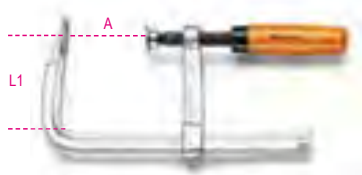

A	A max mm	L1 mm	€	Hand	Computer
160	170	80	39,00	2	015930016
200	240	100	59,50	2	015930020
300	320	145	83,50	2	015930030

1594 Schraubzwingen

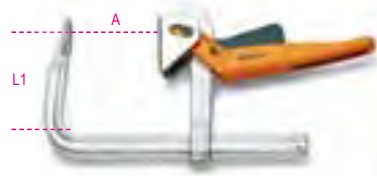

A	A max mm	L1 mm	€	Hand	Computer
200	240	145	131,00	1	015940020
250	290	145	136,00	1	015940025
300	340	145	145,00	1	015940030
400	430	150	152,00	1	015940040
500	530	150	160,00	1	015940050
600	630	150	167,00	1	015940060

1595 Schraubzwingen

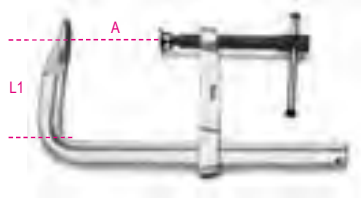

A	A max mm	L1 mm	€	Hand	Computer
200	230	100	62,00	2	015950020
250	270	120	67,50	2	015950025
300	330	120	86,00	2	015950030
400	420	120	96,50	2	015950040
500	520	125	106,00	2	015950050
600	620	125	112,00	2	015950060
800	820	125	132,00	1	015950080
1000	1030	125	147,00	1	015950100

1599F

Parallelschraubstöcke für Werkbänke,
geschmiedet
Völlig aus Stahlguss hergestellt. Oberflächlich gefräst und
gehärtet.
Vordere Öffnung. Hohe Spannungstiefe.



L1 mm	BxH mm	Ø mm	A MAX mm	€	Hand	Computer
100	92x46	11	125	385,00	1	015990100
125	108x54	13	150	492,00	1	015990125
150	125x62	13	200	692,00	1	015990150
175	140x70	15	220	944,00	1	015990175

1599GI

Parallelschraubstöcke mit auswechselbaren
Backen

- Mit Vierkantführung für anspruchsvolle Arbeiten
- Auswechselbare Backen mit gehärteter Oberfläche

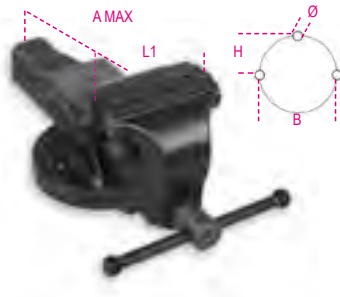

L1 mm	BxH mm	Ø mm	A MAX mm	€	Hand	Computer
100	92x46	11	125	297,00	1	015990200
125	108x54	13	150	409,00	1	015990225
150	125x62	13	200	559,00	1	015990250
175	140x70	15	220	745,00	1	015990275

1599GR

Spannbackenpaare und Ersatzschrauben für
Schraubstöcke Art. 1599GI



	A mm	€	Hand	Computer
1599GR 100	100	28,50	1	015990920
1599GR 125	125	36,00	1	015990925
1599GR 150	150	43,50	1	015990950
1599GR 175	175	51,00	1	015990975

1599P

Parallelschraubstöcke für Werkbänke

Gehärtete Backen.
Amboss mit großer lackierter Oberfläche.
Viereckige Basis aus Stahl.

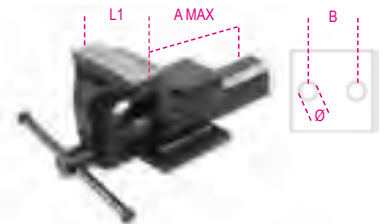

L1 mm	B mm	Ø mm	A MAX mm	€	Hand	Computer
100	92	11	111	339,00	1	015990000
125	108	13	130	407,00	1	015990025
150	130	15	170	567,00	1	015990050

1599B

Drehbasen für Schraubstöcke Art. 1599P



	1599P mm	€	Hand	Computer
1599B 100	100	142,00	1	015990810
1599B 125	125	161,00	1	015990812
1599B 150	150	199,00	1	015990815

1599T

Parallelschraubstöcke für Bohrer

Schraubstöcke aus Spezialgussisen, mit gehärteten und
geschliffenen Backen.
An kleinen und mittelgroßen Säulenbohrmaschinen
anbringbar

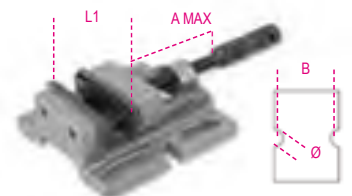

L1 mm	B mm	Ø mm	A MAX mm	€	Hand	Computer
80	111	11	65	191,00	1	015990480
100	120	13	87	237,00	1	015990500

1599G

Spannbackenpaare aus Aluminium

- Über die gesamte Länge magnetisch
- Mit Innenfräsung für den Halt der Gewindeteile



A mm	€	1	015990910
100	62,00	1	015990910
125	64,00	1	015990912
150	70,50	1	015990915
180	78,00	1	015990917

1600Q 8

Kreuzschlüssel für Schaltschränke

- Vierkant 5 / 6 / 7-8 mm
- Dreieck 7 / 9 mm
- Flügel 3-5 mm
- Sechskant 1/4"
- Doppelseinsatz mit Schlitz 1,0x7 mm und Kreuzschlitz PH2



L mm	€	1	016000008
76	34,50	1	016000008

1600Q 10

Doppelkreuz-Gelenkschlüssel für Schaltschränke

- Vierkant 5 / 6-7 / 8-9 mm
- Dreieck 5-6-7 / 8-9 / 10 mm
- Flügel 3-5 mm
- Sechskant 1/4"
- Außenvierkant 1/4"

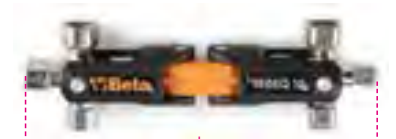

L mm	€	1	016000010
125	44,50	1	016000010

ZERTIFIZIERUNGSSERVICE MESSGERÄTE

Die Zertifizierung von Messgeräten ist unerlässlich in jenen Sektoren oder Anwendungsbereichen, in denen die Genauigkeit und Richtigkeit der Messung auf eindeutige und erkennbare Weise gekannt und kontrolliert werden muss.

Die Zertifizierung sieht die Ausstellung eines Accredia Zertifikats vor:

Beta Utensili S.p.A. bietet auf Anfrage hin den Zertifizierungsservice für Schieblehren mit oder ohne Digitalanzeige, Messuhren, Mikrometer und Messfühler. Zur Nutzung dieses Service wenden Sie sich bitte an Ihren Händler.



1650

Schieblehre

Präzision: 1/20 mm

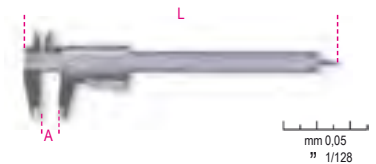

UNI EN ISO 13385-1DIN 862

A max mm	L mm	€	1	016500001
150	235	72,00	1	016500001
200	290	95,00	1	016500002

1650FD

Schieblehre für Bremscheiben,

Präzision: 1/10 mm

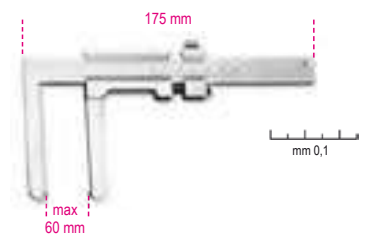

1650FD	€	1	016500050
	256,00	1	016500050

1650FT

Schieblehre für Bremsstromeln,

Präzision: 1/20 mm



1650FT/1	A max mm	L mm	€	1	016500060
	350	438	479,00	1	016500060
1650FT/2	500	550	837,00	1	016500070

1651DGTB

Schieblehre mit Digitalanzeige

Präzision: 1/100 mm

Eigenschaften:

- Präzision: 1/100 mm
- Schraubverriegelung des Schiebers
- Anzeige umschaltbar metrisch/zöllig
- 0-Rückstellung in jeder Position
- Vierkant-Tiefenstab bis zu 300 mm
- In festem Etui aus Kunststoff

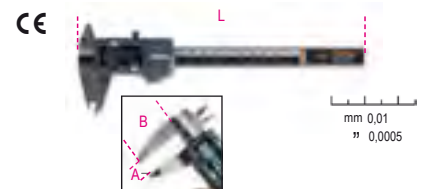

UNI EN ISO 13385-1DIN 862CE

A Max mm	L mm	B mm	€	1	016510211
150	235	40	122,00	1	016510211
200	285	50	159,00	1	016510212
300	400	60	207,00	1	016510213

Beta

1651DGTB/IP

Schieblehre mit Digitalanzeige
Präzision: 1/100 mm
Schutzgrad: IP67

- Präzision: 1/100 mm
- Schraubverriegelung des Schiebers
- Anzeige umschaltbar metrisch/zöllig
- Automatische Einschaltung durch die Verschiebung des Schiebers
- 0-Rückstellung in jeder Position
- HOLD-Funktion
- Wechsel zwischen absoluter und inkrementaler Messung möglich

Der Schutzgrad IP67 garantiert einen totalen Schutz gegen Staub und Flüssigkeiten, sodass selbst bei vollständigem Eintauchen des Gerätes in Wasser dessen Funktionseigenschaften beibehalten werden.

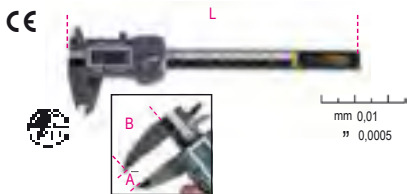

UNI EN ISO 13385-1 DIN 862CE

A Max	L	B	€		
mm	mm	mm			
150	235	40	199,00	1	016510711

270x115x35 mm - 450 g

1652

Schieblehre mit Analoganzeige,
Präzision: 1/50 mm

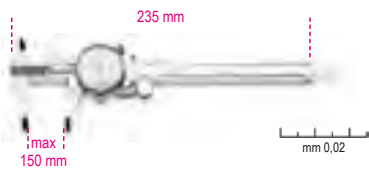

UNI EN ISO 13385-1DIN 862

1652	€		
153,00	1	016520016	

1654

Schieblehren
Präzision: 1/50 mm



UNI EN ISO 13385-1DIN 862

A max	L	€		
mm	mm			
200	330	334,00	1	016540020
300	410	453,00	1	016540030

Beta

1654DGT

Schieblehre mit Digitalanzeige,
Präzision: 1/100 mm

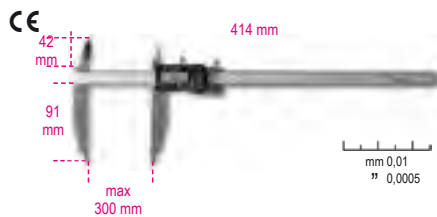

UNI EN ISO 13385-1DIN 862CE

1654DGT	€		
765,00	1	016540111	

1656

Tiefenmaße, Präzision: 1/50 mm

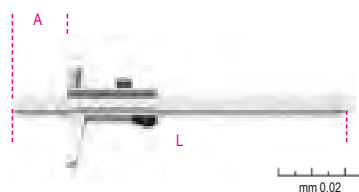

UNI EN ISO 13385-2DIN 862

A max	L	€		
mm	mm			
200	260	159,00	1	016560020
300	360	233,00	1	016560030

1657DGT/2

Tiefenmaße mit Digitalanzeige,
Präzision: 1/100 mm

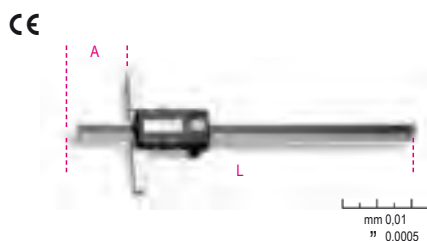

UNI EN ISO 13385-2DIN 862CE

1657DGT/2	A max	L	€		
	mm	mm			
	200	270	295,00	1	016570002

1658/...

Mikrometer für Außenmessungen,
Präzision: 1/100 mm



DIN 863/II

	A	€		
	mm			
1658/25	0÷25	91,00	1	016580025
1658/50	25÷50	99,00	1	016580050
1658/75	50÷75	112,00	1	016580075
1658/100	75÷100	123,00	1	016580100

1658/C4

Sortiment mit 4 Mikrometern
Art. 1658



DIN 863

1658/C4	€		
366,00	1	016580001	

1658/25 0÷25 mm

1658/50 25÷50 mm

1658/75 50÷75 mm

1658/100 75÷100 mm

365x245x35 mm - 2,5 kg

1658DGTB

Digital-Mikrometer für Außenmessungen IP65
Präzision: 1/1000 mm

- Präzision: 1/1000 mm
- Hartmetallkontakte
- Hebelverriegelung des Schiebers
- Anzeige umschaltbar metrisch/zöllig
- 0-Rückstellung in jeder Position
- Wechsel zwischen absoluter und inkrementaler Messung möglich
- Inkl. Einstellschlüssel



DIN 863CE

1658DGTB 25	€		
249,00	1	016580525	
1658DGTB 50	309,00	1	016580550

Beta

Beta

1658SP/1

Halter für Mikrometer



1658SP/1 € 63,00 1 016580910

1659

Dickenmessgerät,
Präzision: 1/100 mm

C= Messbereich



1659 C mm 0=10 € 234,00 1 016590001

1662/1 - 1662/2

Messuhr, Präzision: 1/100 mm

C= Messbereich



DIN 878
1662/1 C mm 0÷5 € 108,00 1 016620001
1662/2 C mm 0÷10 € 130,50 1 016620010

1662DGT/A

Messuhr mit Digitalanzeige
Präzision: 1/100 mm

C = Messbereich

CE



1662DGT/A C mm 0-12,5 € 325,00 1 016620311

1662AN

Messuhr mit Hebel,
Präzision: 1/100 mm

C= Messbereich



DIN 2270
1662AN C mm 0=0,8 € 254,00 1 016620200

1662SP0

Messtischfuß, magnetisch



1662SP0 € 90,50 1 016620800

1662SP2

Messtischfuß, magnetisch, gelenkig



1662SP2 € 163,50 1 016620910



1666

Winkel, aus rostfreiem Stahl,
geschliffen und geläppt



DIN 875/0
L mm L1 mm € 1 016660210
100 70 74,50
150 100 109,00
200 130 130,00
250 165 168,00
300 200 211,00 1 016660230

1666A

Winkel mit Anschlag,
aus rostfreiem Stahl,
geschliffen und geläppt



DIN 875/0
L mm L1 mm € 1 016660110
100 70 110,00
150 100 148,00
200 130 208,00
250 170 259,00
300 200 327,00 1 016660130

1668

Winkel
aus normalgeglühtem Stahl,
geschliffen



DIN 875/2
L mm L1 mm € 1 016680210
100 70 33,00
150 100 44,00
200 130 57,00
250 165 82,50
300 174 102,00 1 016680230

1668A

Winkel, mit Anschlag, aus normalgeglühtem Stahl, geschliffen



DIN 875/2

L mm	L1 mm	€		
100	70	39,00	2	016680110
150	100	60,50	2	016680115
200	130	76,50	2	016680120
250	165	111,00	1	016680125
300	176	132,00	1	016680130

1670

Winkel, aus Stahl, geschliffen



L mm	L1 mm	€		
100	70	20,50	3	016700010
150	100	21,40	3	016700015
200	130	24,10	3	016700020
250	160	26,00	3	016700025
300	175	29,50	3	016700030
400	230	43,50	2	016700040
500	280	48,00	2	016700050
600	330	51,00	2	016700060
800	420	69,00	1	016700080
1000	500	82,50	1	016700099

1670A

Winkel mit Anschlag, aus Stahl, geschliffen



L mm	L1 mm	€		
100	70	27,00	3	016700110
150	100	29,50	3	016700115
200	130	32,00	3	016700120
250	165	38,00	3	016700125
300	175	44,50	3	016700130
400	230	58,50	2	016700140
500	280	78,00	2	016700150
600	330	87,50	2	016700160
800	420	105,00	1	016700180
1000	500	130,00	1	016700199

1672

Verstellbarer Winkel, aus Stahl

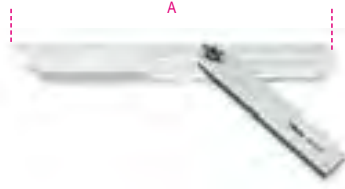

A mm	€		
300	62,50	2	016720030

1672A

Verstellbare Winkel, aus verchromtem Stahl, Schenkel aus Aluminium

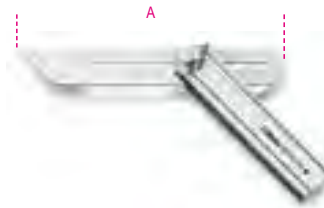

A mm	€		
200	32,50	3	016720120
300	36,00	3	016720130

1674A

Schreinerwinkel, aus Stahl, Schenkel aus Aluminium, doppelte Millimeterteilung



L mm	L1 mm	€		
300	169	31,00	2	016740130
400	214	38,50	2	016740140

1674C

Kombinationswinkel für Schreiner mit Stahlblatt und Wasserwaage

- Doppelte Millimeterteilung
- Wasserwaage



L mm	€		
300	23,00	2	016740230

1676

Winkelmesser, Standardausführung, aus rostfreiem Stahl

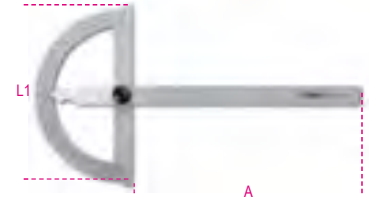

A mm	A mm	L1 mm	G mm	€		
120	120	80	1°	48,50	2	016760012
150	165	120	1°	56,00	2	016760015
200	210	150	1°	67,50	2	016760020
300	310	200	1°	91,00	1	016760030

1678/C3

Winkelmesser, Luxusausführung, aus rostfreiem Stahl

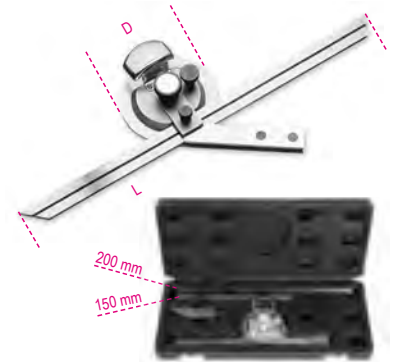

L Max mm	D mm	€		
300	70	347,00	1	016780030

1679

Universalanreißlehre mit Anschlag-Rolle, aus rostfreiem Stahl, Präzision: 1/10 mm

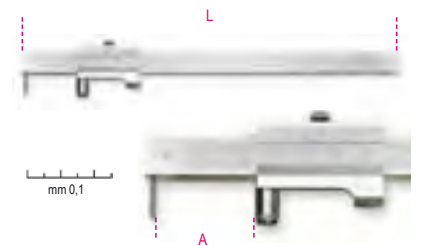

L mm	A Max mm	€		
235	200	105,00	1	016790020

1679/PR

Ersatzspitze für Lehre Art. 1679



L mm	€		
300	16,90	1	016790021

1680

Stangenzirkel, Körper und Spitzen aus gehärtetem Stahl

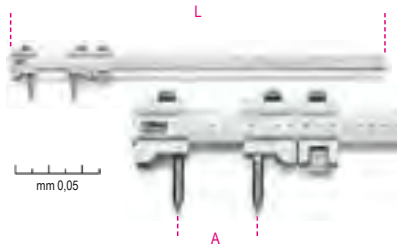

L mm	A Max mm	€	U	W
660	500	347,00	1	016800050

1680A

Zirkel mit Innentaster

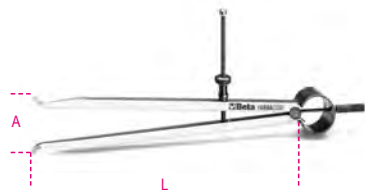

L mm	A Max mm	€	U	W
150	144	22,60	2	016800115
200	200	27,50	2	016800120
250	245	34,00	1	016800125
300	300	39,00	1	016800130

1680B

Greifzirkel



L mm	A Max mm	€	U	W
150	155	22,60	2	016800215
200	190	27,50	2	016800220
250	235	34,00	1	016800225
300	280	39,00	1	016800230

1680C

Spitzzirkel gerade Stahlspitzen, gehärtet

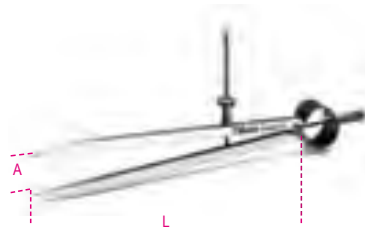

L mm	A Max mm	€	U	W
150	138	22,60	2	016800315
200	190	27,50	2	016800320
250	235	34,00	1	016800325
300	280	39,00	1	016800330

1682

Flexible Maßstäbe, aus rostfreiem Stahl

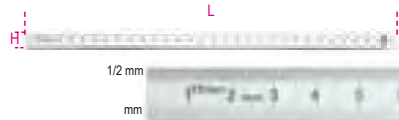

L mm	H mm	± mm	€	U	W
150	13	0,5	3,80	5	016820015
200	13	0,5	4,20	5	016820020
250	13	0,5	5,00	5	016820025
300	13	0,5	6,20	5	016820030
500	13	0,5	13,90	2	016820050
1000	13	0,5	36,50	2	016820100

1683

Halbflexible Maßstäbe, aus rostfreiem Stahl

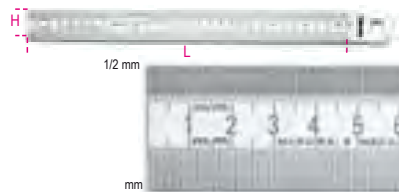

L mm	H mm	± mm	€	U	W
300	30	1	10,90	5	016830030
500	30	1	18,20	2	016830050
1000	30	1	45,50	2	016830100
1500	30	1	103,00	1	016830150

1685/C7

Sortiment mit 7 Mess- und Anreißwerkzeugen



1685/C7	€	U	W
	353,00	1	016850110

	1650	160 mm
	1658/25	0+25 mm
	1670	100 mm
	1680C	150 mm
	1682	150 mm
	1688BC	165 mm
	1688BC/R	

320x210x37 mm - 1,2 kg

1687A

Präzisionsreißnadel mit Griff, um 90° gebogen



1687A	L mm	L1 mm	€	U	W
	153	80	7,80	1	016870120

1687AC

Präzisionsreißnadel mit Griff, um 90° gebogen, kurze Ausführung



1687AC	L mm	L1 mm	€	U	W
	153	80	7,80	1	016870125

1687D

Präzisionsreißnadel mit Griff, gerade



1687D	L mm	L1 mm	€	U	W
	153	80	7,80	1	016870110

1687U

Präzisionsreißnadel mit Griff, hakenförmig



1687U	L mm	L1 mm	€	U	W
	153	80	7,80	1	016870115

1687/S4

Präzisionsreißnadelnsatz mit Griff, 4teilig



1687/S4	€	U	W
1687A-1687AC 1687D-1687U	31,00	1	016870150

1688

Reißnadel, aus gehärtetem Stahl



	L mm	Ø mm	€	📦	📄
1688	250	2	10,20	5	016880020

1688A

Reißnadel, aus gehärtetem Stahl,
Spitzen aus Wolframkarbid



	L mm	Ø mm	€	📦	📄
1688A	200	4	18,30	5	016880120

1688PC

Reißnadel,
aus gehärtetem Stahl, verchromt



	L mm	Ø mm	€	📦	📄
1688PC	150	1	43,50	1	016880300

1688PC/R

Ersatzspitze für Art. 1688PC



	€	📦	📄
1688PC/R	12,70	1	016880310

1688M

Schreinerbleistift



	L mm	€	📦	📄
1688M	180	1,40	50	016880880

1690F

Gliedermaßstab aus Glasfaser
Präzisionsklasse: III

CE



	L m	S mm	€	📦	📄
1690F/2	2	17	14,50	5	016900220

1690L

Gliedermaßstab aus Birkenholz
Präzisionsklasse: III

CE



	L m	S mm	€	📦	📄
1690L/2	2	17	15,90	5	016900200

1691BM

Rollbandmaße
schlagfestes ABS Gehäuse
Stahlband
Präzisionsklasse: II

CE



	L m	S mm	€	📦	📄
1691BM/5	5	25	19,00	1	016910205
1691BM/8	8	32	28,50	1	016910208
1691BM/10	10	32	34,50	1	016910210

1691MG

Rollbandmaße mit festem Magnet,
schlagfestes ABS Gehäuse aus Bimaterial,
Stahlband,
Präzisionsklasse: II

CE



	L m	S mm	€	📦	📄
1691MG/5	5	25	16,60	1	016910405
1691MG/8	8	25	22,80	1	016910408
1691MG/10	10	25	25,00	1	016910410

1692

Rollbandmaße,
schlagfestes ABS Gehäuse aus Bimaterial
Stahlband
Präzisionsklasse: II

CE



	L m	S mm	€	📦	📄
1692/2	2	16	9,40	5	016920052
1692/3	3	16	11,70	5	016920053
1692/5	5	19	16,40	5	016920055
1692/8	8	25	23,70	5	016920058

1693

Laser-Entfernungsmesser, 20 Meter

MESSUNGEN:

- Einzel-Entfernungsmessung
- Dauermessung oder Mindestmessung

Selbstabschaltung

Akku-Dauer: bis zu 4.000 Messungen

CE
IP54



TECHNISCHE DATEN

Messbereich: von 0,05 bis 20m (von 0.2ft bis 66ft)

Skalenauswahl: m, in, ft

Präzision: ±1,5 mm (± 0.06 in)

Laserklasse: 2

Batterien: AAA 2 x 1.5V

	H mm	L mm	S mm	€	📦	📄
1693 20	100	36	23	146,00	1	016930020

1693L

Multifunktions-Laserentfernungsmesser,
40 m,
mit Wasserwaagen

MESSUNGEN:

- Einzel-Entfernungsmessung
- Dauermessung oder Mindestmessung

FUNKTIONEN:

- Addition/Subtraktion
- Flächenmessung
- Volumenmessung
- Indirekte Messung (Pythagoras-Messung)
- Neigungsmessung

Selbstabschaltung

Akku-Dauer: bis zu 5.000 Messungen

Weiches Nylonetui (inklusive)

CE
IP54



Technische Daten:

• Messbereich: 0,05 + 40 m (0.2in + 131f)

• Skalenauswahl: m, in, ft

• Präzision: ±1,5 mm (±0.06 in)

• Laserklasse: 2

• Speicherbare Messungen: 99

• Batterien: AAA 2 x 1.5V

	H mm	L mm	S mm	€	📦	📄
1693L 40	115	50	25	177,00	1	016930040

1693M

Multifunktions-Laserentfernungsmesser,
80 m

MESSUNGEN:

- Einzel-Entfernungsmessung
- Dauermessung oder Mindestmessung

FUNKTIONEN:

- Addition/Subtraktion
- Flächenmessung
- Volumenmessung
- Indirekte Messung (Pythagoras-Messung)
- Neigungsmessung

Selbstabschaltung

Weiches Nylonetui (inklusive)

Akku-Dauer: bis zu 4000 Messungen



TECHNISCHE DATEN

Messbereich: von 0,05 bis 80m (von 0.2 ft bis 229ft)

Skalenauswahl: m, in, ft

Präzision: ±1,5 mm (± 0.06 in)

Laserklasse: 2

Speicherung der Messungen: 99

Batterien: AAA 2 x 1.5V

	H mm	L mm	S mm	€	U	W
1693M 80	115	48	29	248,00	1	016930080

1694/L

Lange Rollbandmaße, schlagfestes
ABS-Gehäuse, Glasfaserband
mit PVC-Ummantelung, Präzisionsklasse: III



	L m	S mm	€	U	W
1694L10	10	13	15,30	1	016940110
1694L20	20	13	19,00	1	016940120

Beta

1694A/L

Lange Rollbandmaße mit Griff,
schlagfestes ABS-Gehäuse,
Glasfaserband mit PVC-Ummantelung,
Präzisionsklasse: III



	L m	S mm	€	U	W
1694A/L30	30	13	38,00	1	016940230
1694A/L50	50	13	49,50	1	016940250

1694B/L

Langes Rollbandmaß mit Griff,
Aluminiumgehäuse, lackiertes
Stahlband, Präzisionsklasse: II



	L m	S mm	€	U	W
1694B/L50	50	12,5	76,00	1	016940350

1695XS

Taschen-Wasserwaage mit V-förmiger
Messfläche,
magnetisch aus profiliertem Aluminium
2 unzerbrechliche Libellen
Präzision: 1 mm/m



	L mm	H mm	S mm	€	U	W
1695XS	70	48,5	20	15,40	5	016950250

1696

Wasserwaagen aus Eloxalprofil
mit unzerbrechlichen
Libellen – Präzision: 1 mm/m



	L mm	H mm	S mm	€	U	W
1696	200	50	19	25,50	2	016960002
	400	50	19	30,00	2	016960004
	500	50	19	32,50	2	016960005
	600	50	19	34,50	2	016960006
	800	50	19	43,50	2	016960008
	1000	50	19	48,00	2	016960010

1696A

Wasserwaagen aus druckgeegossenem
Aluminium, mit 1 feinbearbeiteten
Messfläche und 2 unzerbrechlichen
Libellen, Präzision: 1 mm/m



	L mm	H mm	S mm	€	U	W
1696A	300	43	23	37,00	2	016960103
	400	43	23	39,00	2	016960104
	500	43	23	43,00	2	016960105
	600	43	23	46,50	2	016960106
	1000	43	23	93,50	1	016960110

1696B

Magnet-Wasserwaagen aus Eloxalprofil
2 unzerbrechliche Libellen,
Präzision: 1 mm/m



	L mm	H mm	S mm	€	U	W
1696B	200	49	22	39,50	2	016960202
	300	49	22	41,50	2	016960203
	400	49	22	44,00	2	016960204
	500	49	22	53,00	2	016960205
	600	49	22	56,00	2	016960206

Beta

Beta

1696D

Wasserwaagen aus druckgegossenem Aluminium mit Handgriffen, 4 feinbearbeitete Messflächen und 3 unzerbrechliche Libellen, Präzision: 1 mm/m



L mm	H mm	S mm	€		
300	47	25	34,50	2	016960353
400	47	25	39,00	2	016960354
500	47	25	43,00	2	016960355
600	47	25	48,00	2	016960356

1696S

Meßplatten aus Aluminium mit Handgriffen mit 2 unzerbrechlichen Libellen Präzision: 1 mm/m

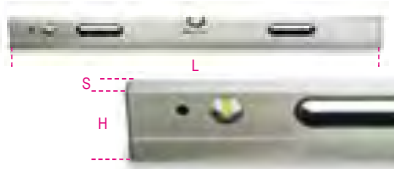

L mm	H mm	S mm	€		
1500	90	25	123,00	1	016960415
2000	90	25	146,00	1	016960420
2500	90	25	182,00	1	016960425
3000	90	25	205,00	1	016960430

1697

Kreuz-Linienlaser, 30 m, grüner Laserstrahl, mit magnetischer Halterung und Wandklemme, im Koffer

TECHNISCHE EIGENSCHAFTEN:

- Selbstnivellierendes Kreuz
- Die Selbstnivellierungsfunktion kann unterbrochen werden
- Laserdiode 515 Nm, Klasse 2
- Reichweite: 30 m
- Messgenauigkeit: ± 1 mm bei 5 m
- Selbstnivellierungsbereich: $3^\circ \pm 0,5^\circ$

- Gehäuse aus ABS und rutschfestem Gummi

- 1/4" Innengewinde
- Batterien: 2xAA
- Batterielebensdauer: 4 Stunden

HALTERUNGEN:

- 1 magnetische Halterung zur einzelnen und kombinierten Verwendung, mit 1/4" Außengewinde
- 1 Halterung mit Klemme für Profile aus Holz und Metall (zur Verwendung in Kombination mit der magnetischen Halterung)
- Schnelle horizontale und vertikale Ausrichtung bei einem Winkel von 90° möglich

CE



IP55



H mm	L mm	S mm	€		
82	57	89,5	303,00	1	016970030

320x230x90 mm

1699L

Präzisions-Wasserwaage aus Gusseisen, mit prismenförmigen Rillen, geschliffene Messflächen, 2 unzerbrechliche Libellen, Präzision: 0,05 mm/m



DIN 877

	L mm	A mm	€		
1699L	200	49	366,00	1	016990002

1699L/1

Präzisions-Wasserwaage aus Gusseisen, mit prismenförmigen Rillen, geschliffene Messflächen, 2 unzerbrechliche Libellen, Präzision: 0,02 mm/m



DIN 877

	L mm	A mm	€		
1699L/1	200	49	390,00	1	016990005

1699Q

Präzisions-Wasserwaagen mit Rahmen aus Gusseisen, mit prismenförmigen Rillen auf 2 geschliffenen Messflächen, 2 unzerbrechliche Libellen, Präzision: 0,05 mm/m



DIN 877

L mm	A mm	€		
150	40	519,00	1	016990015
200	48	649,00	1	016990020

1700N

Maurerspitze



L mm	S mm	€		
250	16	19,30	5	017000005
300	16	20,80	5	017000006

1700N/PM

Maurerspitze mit Handschutz



L mm	S mm	€		
250	16	26,00	2	017000105
300	16	30,50	2	017000106

1701N

Maurerflachmeißel



L mm	A mm	S mm	€		
250	23	16	20,70	5	017010001
300	23	16	22,30	5	017010003

1701N/PM

Maurerflachmeißel mit Handschutz



L mm	A mm	S mm	€		
250	23	16	27,00	2	017010101
300	23	16	30,50	2	017010103



1701PMR

Ersatzhandschutz für Art. 1700N
und Art. 1701N

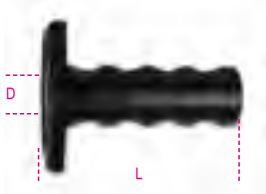

D mm	L mm	€	U	IT
16	115	12,60	1	017010206

1701NE/...

Elektrikermeißel



	SxL mm	€	U	IT
1701NE3	10x200	12,80	5	017010406
1701NE4	10x250	13,50	5	017010409

1702N

Schlitzmeißel



A mm	SxH mm	€	U	IT
50	13x23	27,00	2	017020005
70	13x23	28,00	2	017020007

1702N/PM

Schlitzmeißel
mit Handschutz



A mm	SxH mm	€	U	IT
50	13x23	33,00	2	017020105
70	13x23	36,50	2	017020107



Das Werkzeug sollte während
des Nachschleifens häufig
gekühlt werden.

1702PMR

Ersatzhandschutz für Art. 1702N



L mm	€	U	IT
115	9,70	1	017020200

1704

Nageleisen mit gehärteten Enden



L mm	Ø mm	€	U	IT
500	16 35 28	34,50	2	017040050
600	16 34 26	39,00	2	017040060
800	18 38 29	55,00	2	017040080

1704A

Eisen mit gehärteten Spitzen und Meißelenden

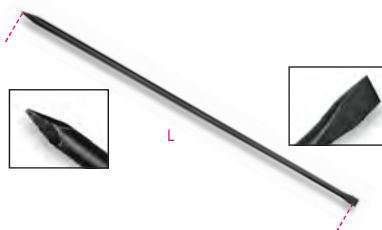

L mm	Ø mm	€	U	IT
1500	25 45	118,00	1	017040110
2000	25 55	138,00	1	017040120

1704C

Hebel mit spitzen Enden
und durchgesteckter Pinne



L mm	Ø mm	€	U	IT
1200	21-31 39	119,00	1	017040210
1400	31-37 42	142,00	1	017040212
1600	25-37 42	176,00	1	017040215

1705

Markierschnur aus Aluminium



L m	€	U	IT
1705 30	23,30	4	017050001

1705PT

Markierpuder

- Behälter mit Spender.
- Blau



g	€	U	IT
250	15,00	5	017050025

1706DGT

Digital-Tiefenmaß für Reifenprofile



1706DGT	€	U	IT
	44,00	1	017060011

1707

Gewindelehre

Für ISO-Gewindegang 60° und Whitworth-Gewindegang 55°.



P (ISO)	W	€	U	IT
0,25÷6	62÷4x1"	20,60	5	017070001

1707A/1 - 2 - 3

Radienlehren, Blätter aus Stahl,
für konkave und konvexe Radien



	R mm	L mm	n	€	U	IT
1707A/1	1,0÷7,0	70	34	32,00	2	017070007
1707A/2	7,5÷15	85	32	34,00	2	017070015
1707A/3	15,5÷25	85	30	34,00	2	017070025

1708/8 - 13 - 20

Fühlerlehren



	€		
1708/8 S = 0,05±0,50 mm	7,90	5	017080008
1708/13 S = 0,05±1,00 mm	9,00	5	017080013
1708/20 S = 0,05±1,00 mm	14,30	5	017080020

1709/10 - 1709/18

Muttersprenger



	L mm	A max mm	€		
1709/10	82,5	17 (M10)	63,00	1	017090010
1709/18	107,8	24 (M16)	69,50	1	017090018

1710

Muttersprenger, hydraulisch



	C min mm	C max mm	€		
7 (M4)	7	22 (M14)	291,00	1	017100001

1712E/1 - 2 - 3

Magnetheber, flexibel

F = Magnetkraft



	L mm	D mm	F kg	€		
1712E/1	420	7,5	0,5	37,50	2	017120011
1712E/2	530	15	1,8	47,50	2	017120012
1712E/3	532	19	3,0	58,50	2	017120013

1712TF

Teleskopmagnetheber mit flexiblem Kopf

• Mit Scheibenwaschdüsenreiniger
F = Magnetkraft



	L mm	D mm	F kg	€		
150÷590	150÷590	11	1	24,80	1	017120600

1713M

Krallengreifer, flexibel

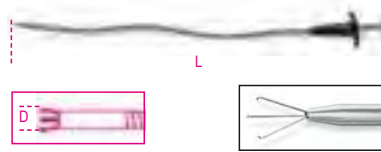

	L mm	D mm	€		
500	500	7	52,00	2	017130011
1000	1000	7	91,50	1	017130015

1713M/K7

Inspektions-Werkzeugsatz, 7-teilig, Sechskantanschluss 1/4"

Satzinhalt:

- 1 Teleskopgriff, Länge 185-660 mm
- 1 rechteckiger Spiegel, 65x43 mm
- 1 runder Spiegel, Ø 52 mm
- 1 Magnet, Ø 16,3 mm
- 1 ultrahelles LED-Licht
- 1 Krallengreifer, flexibel (Art. 1713M)
- 1 magnetische Kleinteile-Ablageschale aus Edelstahl
- 3 LR44 Zell-Batterien



	€		
1713M/K7	185,00	1	017130100

297x165x52 mm - 0,8 kg

1714

Inspektionsspiegel, starr, aus Kunststoff



	L mm	D mm	€		
1714	155	25	4,70	5	017140001

1715

Inspektionsspiegel, teleskopisch, mit Gelenk, Metallgestell, verchromt



	L mm	D mm	€		
1715	180÷540	30	39,00	1	017150001

1715FL/A

Inspektionsspiegel, flexibel, quadratisch

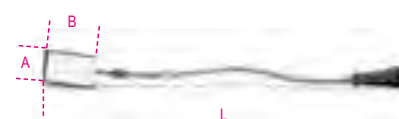

	L mm	A mm	B mm	€		
1715FL/A	600	53	90	47,00	1	017150110

1715R/FL

Kit mit 2 Ersatzinspektionsspiegeln für Art. 1715FL/A und Art. 1715FL/B

	€		
1715R/FL	10,00	1	017150151

1715FL/B

Inspektionsspiegel mit Beleuchtung, flexibel, rechteckig

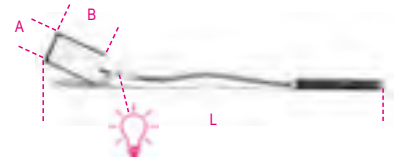

	L mm	A mm	B mm	€		
1715FL/B	553	53	90	56,00	1	017150115

1715B/R5L

Kit mit 5 Ersatzglühbirnen für Art. 1715FL/B

	€		
1715B/R5L	8,10	1	017150152

1715I

Teleskop-Gelenkspiegel mit 5-facher Vergrößerungsfunktion

- Griff aus rutschfestem PVC
- Spiegelrahmen und Stiel aus Edelstahl



	L mm	D mm	€		
1715I	250÷720	55	37,00	1	017150020

1715L

Teleskop-Gelenkspiegel mit LED-Licht

- Körper aus Edelstahl
- Taschenclip
- 3 Batterien Typ L736F im Lieferumfang



	L mm	D mm	€		
1715L	265÷765	50	58,00	1	017150005

1716A

Eckige Spitze zum allgemeinen Gebrauch



	L mm	L1 mm	mm	€		
1716A	240	125	6	13,40	3	017160040

1716P

Schaber für Dichtungen

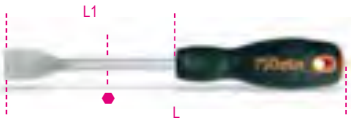

L	L1	•	€	🔧	📦
mm	mm	mm			
1716P	250	125	6	16,50	3 017160020

1716R

Rundvorstecher



L	L1	Ø	€	🔧	📦
mm	mm	mm			
1716R	215	100	6	11,60	5 017160001

1716U

Hakenspitze zum allgemeinen Gebrauch

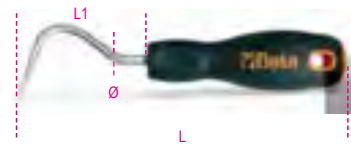

L	L1	Ø	€	🔧	📦
mm	mm	mm			
1716U	195	80	6	13,40	3 017160025

1717A

Löffelschaber



L	L1	L2	€	🔧	📦
mm	mm	mm			
1717A	150	70	260	25,50	2 017170015
	200	75	310	27,00	2 017170020
	250	100	360	30,50	2 017170025

1717B

Dreikantschaber



L	L1	L2	€	🔧	📦
mm	mm	mm			
1717B	150	75	260	21,90	2 017170115
	200	85	310	25,50	2 017170120
	250	100	360	28,50	2 017170125

1717C

Flache Schaber



L	S	L1	€	🔧	📦
mm	mm	mm			
1717C	150	18	270	21,70	2 017170215
	200	20	320	24,30	2 017170220
	250	25	370	27,50	2 017170225

1717D

Flachtrennschaber



L	S	L1	€	🔧	📦	
mm	mm	mm				
1717D	150	150	23	240	30,00	2 017170320

1717T

Schaber mit Dreikantklinge, komplett mit 2 Klingen



L	€	🔧	📦
mm			
1717T	310	13,90	1 017170610

1717T RT

Ersatz-Dreikantklingen



L	€	🔧	📦
mm			
1717T RT	65	2,90	1 017170660

1717T RS

Geförnte Ersatzklingen



L	€	🔧	📦
mm			
1717T RS	65	2,90	1 017170661

1717V

Lackschaber mit mehrseitig verwendbarer Klinge



L	A	€	🔧	📦	
mm	mm				
1717V	38	200	38	9,40	1 017170703
1717V	65	285	65	19,90	1 017170706

1717V R

Ersatzklingen für Art. 1717V



L	€	🔧	📦
mm			
1717V R	38	2,90	1 017170753
1717V R	65	4,30	1 017170756

HIEBARTEN VON MASCHINENFEILEN

Grob

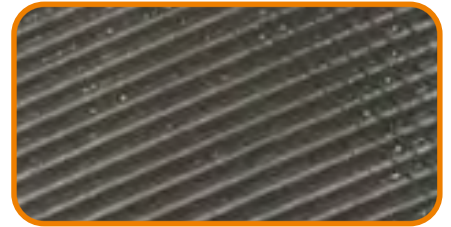

Halbschlicht



Schlicht



1718D...Q

Vierkantfeilen grob, ohne Griff



	L	L	€	🔧	📦
	mm	"			
1718D6/Q	150	6	11,00	5	017180121
1718D8/Q	200	8	13,00	5	017180131
1718D10/Q	250	10	17,70	5	017180141

1718A...Q

Vierkantfeilen halbschlicht, ohne Griff



	L	L	€	🔧	📦
	mm	"			
1718A6/Q	150	6	11,20	5	017180021
1718A8/Q	200	8	13,40	5	017180031
1718A10/Q	250	10	18,50	5	017180041

1718D...T

Dreieckfeilen grob, ohne Griff



	L mm	L "	€	5	017180123
1718D6/T	150	6	13,10	5	017180123
1718D8/T	200	8	16,70	5	017180133
1718D10/T	250	10	22,00	5	017180143

1718A...T

Dreieckfeilen halbschlicht, ohne Griff



	L mm	L "	€	5	017180023
1718A6/T	150	6	13,40	5	017180023
1718A8/T	200	8	17,10	5	017180033
1718A10/T	250	10	23,10	5	017180043

1718D...P

Flachfeilen grob, ohne Griff



	L mm	L "	€	5	017180125
1718D6/P	150	6	10,30	5	017180125
1718D8/P	200	8	12,10	5	017180135
1718D10/P	250	10	16,20	5	017180145

1718A...P

Flachfeilen halbschlicht, ohne Griff



	L mm	L "	€	5	017180025
1718A6/P	150	6	11,00	5	017180025
1718A8/P	200	8	12,70	5	017180035
1718A10/P	250	10	17,70	5	017180045

1718D...M

Halbrundfeilen grob, ohne Griff



	L mm	L "	€	5	017180127
1718D6/M	150	6	14,50	5	017180127
1718D8/M	200	8	17,80	5	017180137
1718D10/M	250	10	23,10	5	017180147

1718A...M

Halbrundfeilen halbschlicht, ohne Griff



	L mm	L "	€	5	017180027
1718A6/M	150	6	14,70	5	017180027
1718A8/M	200	8	18,30	5	017180037
1718A10/M	250	10	24,30	5	017180047

1718D...R

Rundfeilen grob, ohne Griff



	L mm	L "	€	5	017180129
1718D6/R	150	6	10,30	5	017180129
1718D8/R	200	8	12,10	5	017180139
1718D10/R	250	10	15,90	5	017180149

1718A...R

Rundfeilen halbschlicht, ohne Griff



	L mm	L "	€	5	017180029
1718A6/R	150	6	11,00	5	017180029
1718A8/R	200	8	12,70	5	017180039
1718A10/R	250	10	16,80	5	017180049

1718D...S5

Feilensatz, 5-teilig, grob, ohne Griff



	L mm	L "	€	1	017180130
1718D6/S5	150	6	59,00	1	017180130
1718D8/S5	200	8	71,50	1	017180140
1718D10/S5	250	10	95,00	1	017180150

1718A...S5

Feilensatz, 5-teilig, halbschlicht, ohne Griff



	L mm	L "	€	1	017180030
1718A6/S5	150	6	61,00	1	017180030
1718A8/S5	200	8	73,50	1	017180040
1718A10/S5	250	10	101,00	1	017180050

1719BMD...Q

Vierkantfeilen grob, mit Griff

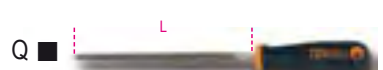

	L mm	L "	€	5	017190191
1719BMD6/Q	150	6	14,90	5	017190191
1719BMD8/Q	200	8	16,50	5	017190221
1719BMD10/Q	250	10	22,60	5	017190241
1719BMD12/Q	300	12	30,00	3	017190325

1719BMA...Q

Vierkantfeilen halbschlicht, mit Griff



	L mm	L "	€	5	017190021
1719BMA6/Q	150	6	15,00	5	017190021
1719BMA8/Q	200	8	18,00	5	017190052
1719BMA10/Q	250	10	23,50	5	017190071
1719BMA12/Q	300	12	34,50	3	017190311

1719BMX...Q

Vierkantfeilen schlicht, mit Griff

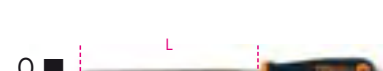

	L mm	L "	€	5	017190022
1719BMX6/Q	150	6	16,00	5	017190022
1719BMX8/Q	200	8	20,70	5	017190053
1719BMX10/Q	250	10	28,00	5	017190072

1719BMD...T

Dreieckfeilen grob, mit Griff

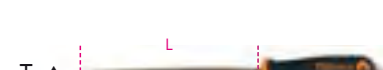

	L mm	L "	€	5	017190193
1719BMD6/T	150	6	17,80	5	017190193
1719BMD8/T	200	8	20,40	5	017190223
1719BMD10/T	250	10	27,00	5	017190243
1719BMD12/T	300	12	39,00	3	017190326

1719BMA...T

Dreieckfeilen, halbschlicht, mit Griff



	L mm	L "	€	5	017190023
1719BMA6/T	150	6	17,80	5	017190023
1719BMA8/T	200	8	22,00	5	017190054
1719BMA10/T	250	10	28,00	5	017190073
1719BMA12/T	300	12	41,00	3	017190313

1719BMX...T

Dreieckfeilen schlicht, mit Griff



	L mm	L "	€	5	017190024
1719BMX6/T	150	6	21,00	5	017190024
1719BMX8/T	200	8	27,00	5	017190055
1719BMX10/T	250	10	35,00	5	017190074

1719BMD...P

Flachfeilen grob, mit Griff



	L mm	L "	€	U	W
1719BMD6/P	150	6	14,90	5	017190195
1719BMD8/P	200	8	15,70	5	017190225
1719BMD10/P	250	10	22,20	5	017190245
1719BMD12/P	300	12	29,00	3	017190327

1719BMA...P

Flachfeilen halbschlicht, mit Griff



	L mm	L "	€	U	W
1719BMA6/P	150	6	15,70	5	017190025
1719BMA8/P	200	8	17,80	5	017190056
1719BMA10/P	250	10	22,90	5	017190075
1719BMA12/P	300	12	33,00	3	017190315

1719BMX...P

Flachfeilen schlicht, mit Griff



	L mm	L "	€	U	W
1719BMX6/P	150	6	16,00	5	017190026
1719BMX8/P	200	8	21,00	5	017190057
1719BMX10/P	250	10	27,00	5	017190076

1719BMD...M

Halbrundfeilen grob, mit Griff



	L mm	L "	€	U	W
1719BMD6/M	150	6	19,60	5	017190197
1719BMD8/M	200	8	21,00	5	017190227
1719BMD10/M	250	10	28,50	5	017190247
1719BMD12/M	300	12	39,50	3	017190328

1719BMA...M

Halbrundfeilen halbschlicht, mit Griff



	L mm	L "	€	U	W
1719BMA6/M	150	6	20,40	5	017190027
1719BMA8/M	200	8	23,80	5	017190058
1719BMA10/M	250	10	30,50	5	017190077
1719BMA12/M	300	12	44,00	3	017190317

1719BMX...M

Halbrundfeilen schlicht, mit Griff



	L mm	L "	€	U	W
1719BMX6/M	150	6	21,70	5	017190028
1719BMX8/M	200	8	26,50	5	017190059
1719BMX10/M	250	10	37,50	5	017190078

1719BMD...R

Rundfeilen grob, mit Griff



	L mm	L "	€	U	W
1719BMD6/R	150	6	14,90	5	017190199
1719BMD8/R	200	8	15,50	5	017190229
1719BMD10/R	250	10	21,60	5	017190249
1719BMD12/R	300	12	28,50	3	017190329

1719BMA...R

Rundfeilen halbschlicht, mit Griff



	L mm	L "	€	U	W
1719BMA6/R	150	6	15,80	5	017190029
1719BMA8/R	200	8	17,60	5	017190060
1719BMA10/R	250	10	22,40	5	017190079
1719BMA12/R	300	12	30,50	3	017190319

1719BMX...R

Rundfeilen schlicht, mit Griff



	L mm	L "	€	U	W
1719BMX6/R	150	6	18,30	5	017190031
1719BMX8/R	200	8	20,40	5	017190061
1719BMX10/R	250	10	27,00	5	017190081

1719BMA...B5

Feilensatz, 5-teilig, halbschlicht, mit Griff, in Tasche



	L mm	L "	€	U	W
1719BMA8/B5	200	8	99,00	1	017190297
1719BMA10/B5	250	10	128,00	1	017190298

1719BMD...B5

Feilensatz, 5-teilig, grob, mit Griff, in Tasche



	L mm	L "	€	U	W
1719BMD8/B5	200	8	88,50	1	017190303
1719BMD10/B5	250	10	123,00	1	017190305

1719BMD...S5

Feilensatz, 5-teilig, grob, mit Griff



	L mm	L "	€	U	W
1719BMD6/S5	150	6	82,00	1	017190200
1719BMD8/S5	200	8	88,50	1	017190230
1719BMD10/S5	250	10	123,00	1	017190250
1719BMD12/S5	300	12	166,00	1	017190363

1719BMA...S5

Feilensatz, 5-teilig, halbschlicht, mit Griff



	L mm	L "	€	U	W
1719BMA6/S5	150	6	84,00	1	017190030
1719BMA8/S5	200	8	99,00	1	017190070
1719BMA10/S5	250	10	128,00	1	017190080
1719BMA12/S5	300	12	183,00	1	017190361

1719BMX...S5

Feilensatz, 5-teilig, schlicht, mit Griff



	L mm	L "	€	U	W
1719BMX6/S5	150	6	92,50	1	017190032
1719BMX8/S5	200	8	117,00	1	017190069
1719BMX10/S5	250	10	156,00	1	017190082

1719BMB/P

Feilen, flachstumpf,
Griff aus Kunststoff



L mm	L" mm	€	Stk	Art-Nr
250	10	35,00	5	017190152
300	12	41,50	5	017190153

1719BMC

Feilen, halbrund und flachstumpf,
Griff aus Kunststoff



UNI 5569 - UNI 5568

L mm	L" mm	€	Stk	Art-Nr
1719BMC/M 250	250 10	23,50	6	017190252
1719BMC/M 300	300 12	30,00	4	017190253
1719BMC/P 250	250 10	18,60	6	017190262
1719BMC/P 300	300 12	22,90	4	017190263

1719BM/RL

Holzraspel/Feile, flachstumpf,
1 halbrunde Holzraspelseite
1 grobe Feilenseite,
Kunststoffgriff



L mm	L" mm	€	Stk	Art-Nr
1719BM/RL	200 8	18,60	5	017190360

1719BM/RR

Holzraspel, rund,
Kunststoffgriff



L mm	L" mm	€	Stk	Art-Nr
1719BM/RR	200 8	19,50	5	017190351

1719BM/RG

Halbrunde Kabinetttraspel,
Kunststoffgriff



L mm	L" mm	€	Stk	Art-Nr
200	8	20,00	5	017190353

1719BM/RP

Flache Raspel,
Kunststoffgriff



L mm	L" mm	€	Stk	Art-Nr
200	8	20,00	5	017190352

1719BMR/B3

Raspelsatz, 3-teilig, halbschlicht,
mit Griff,
in Hängetasche



L mm	L" mm	€	Stk	Art-Nr
200	8	59,00	1	017190358

1719BMR

Ersatzgriffe für Feilen



Art-Nr	L mm	A mm	€	Stk	Art-Nr
1719BMR/0	95	25	4,40	10	017190950
1719BMR/0B	110	29	4,40	10	017190955
1719BMR/1	110	29	4,40	10	017190951
1719BMR/1B	110	29	4,40	10	017190953
1719BMR/2	123	31	4,40	10	017190952
1719BMR/2B	123	31	4,40	10	017190954

Art-Nr	L mm	A mm	€	Stk	Art-Nr
1719BMR/0	100/150	4/6	▲▲	▲▲	
1719BMR/0B	100/150	6/8	■●	■●	
1719BMR/1	150/200	6/8	▲▲	▲▲	
1719BMR/1B	150/200	6/8	■●	■●	
1719BMR/2	250/300	10/12	▲▲	▲▲	
1719BMR/2B	250/300	10/12	■●	■●	

1720/...

Nadelfeilen,
halbschlicht,
Stiel Ø 3 mm

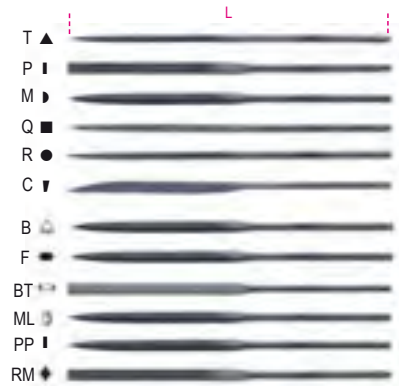

UNI 5569 UNI 5670

Art-Nr	L mm	€	Stk	Art-Nr
1720T	160	8,60	5	017200004
1720P	160	8,60	5	017200006
1720M	160	8,60	5	017200008
1720Q	160	8,60	5	017200009
1720R	160	8,60	5	017200010
1720C	160	8,60	5	017200012
1720B	160	8,60	5	017200005
1720ML	160	8,60	5	017200007
1720BT	160	8,60	5	017200011
1720F	160	8,60	5	017200013
1720PP	160	8,60	5	017200014
1720RM	160	8,60	5	017200015



Art-Nr	€	Stk	Art-Nr
1720/S3	26,00	1	017200000

1720/B



Art-Nr	€	Stk	Art-Nr
1720/B6	54,00	1	017200002
1720/B12	103,00	1	017200003

1720D/...

Diamantnadelfeilen,
Korn D126



Art-Nr	L mm	€	Stk	Art-Nr
1720D/T	160	55,50	2	017200104
1720D/P	160	55,50	2	017200106
1720D/M	160	55,50	2	017200108
1720D/Q	160	55,50	2	017200109
1720D/R	160	55,50	2	017200110
1720D/C	160	55,50	2	017200112



Beta



1720D/B6 € 335,00 1 017200120

1721/B6

Sortiment mit 6 Feilen für Zündkontakte, in Kunststofftasche



1721/B6 € 28,00 1 017210010

1723

Federspanner



1723 L mm 210 € 18,60 5 017230001

1725

Sägebogen

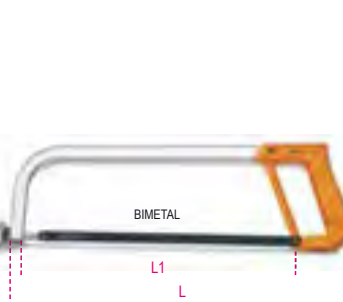

1725 L mm 420 L1 mm 300 € 26,00 4 017250001

1725CR

Minisägebogen



1725CR L mm 250 L1 mm 150 € 14,00 5 017250010

1726

Sägebogen mit Spannsystem des Sägeblatts



1726 L mm 440 L1 mm 300 € 34,00 4 017260001

1726BM

Sägebogen mit Sägeblattspannsystem, Schnellfreigabevorrichtung

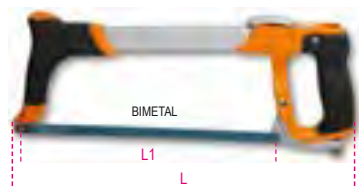

1726BM L mm 400 L1 mm 300 € 55,00 1 017260050

1727

Sägebogen, schwere Ausführung



1727 L mm 515 L1 mm 300 € 23,50 4 017270001

1727BM

Eingriff-Sägebogen



1727BM L mm 315 L1 mm 300 € 28,50 5 017270020

1728...

Sägeblätter



1728LA € 1,70 100 017280001
 1725CR
 1725MQ
 1728BM € 4,40 100 017280010
 1725-1726
 1727-1727M
 1728CO € 5,90 50 017280030
 1725-1726
 1727-1727M

1729CG

Gipskartonsäge



1729CG L mm 310 L1 mm 160 € 28,00 2 017290200

1729DM 450

Holz-Handsäge

mittlere Verzahnung, 12 Zähne pro Zoll



1729DM 450 L mm 450 L1 mm 400 € 32,50 4 017290450

1730

Universalspatel mit Edelstahlklinge und Griff



S mm L mm L1 mm € 017300038
 38 210 85 7,10 2 017300038
 63 220 95 8,50 2 017300063
 75 220 95 9,30 2 017300075
 100 220 95 10,70 2 017300100

1730M

Spatel für Mischgeräte mit Edelstahlklinge und Griff



L1 mm L mm S mm € 017300215
 150 245 27 10,00 2 017300215
 200 330 28 18,50 2 017300220
 250 365 36 22,80 2 017300225

1730V 38

Glaserpachtel, Messerklinge aus Edelstahl



S mm L mm L1 mm € 017300338
 38 225 100 7,10 2 017300338

1736A

Feilenbürste, Edelstahldraht, Draht-Ø 0,5 mm



1736A L mm 240 € 12,90 10 017360010

1737

Messingdrahtbürste, gewellt,
Draht-Ø 0,2 mm



1737	L mm	€	10	017370001
	145	6,40		

1737NX

Messingstahldrahtbürste, gebogene Form,
Draht-Ø 0,3 mm



1737NX	L mm	€	5	017370010
	270	7,60		

1737AC

Stahldrahtbürste,
5-reihig,
Draht-Ø 0,3 mm



1737AC	L mm	€	5	017370020
	275	7,20		

1737B

Pol- und Klemmenreinigungsbürstenpaare,
Stahldraht,
Draht-Ø 0,3 mm



1737B	€	1	017370050
	17,60		

1738

Pinsel



1738	L mm	H mm	€	10	017380001
	210	30	10,30		

1739C

Scherennietgerät,
komplett mit 5 auswechselbaren Mundstücken



Ø mm	3,2	4	4,8	5	6	6,4
Aluminium	•	•	•	•	•	•
Inox	•	•	•	•	•	•

1739C	L max mm	€	1	017390152
	810	150,00		

1740AN

Nietzange, Kraftmodell,
komplett mit 5 auswechselbaren Mundstücken
• Komplett mit Nietensammelbehälter



Ø mm	3,2	4	4,8	5	6	6,4
Aluminium	•	•	•	•	•	•
Inox	•	•	•	•	•	•

1740AN	L mm	€	1	017400103
	530	136,00		

1740B

Nietzange, Kraftmodell, kompakt,
mit 5 auswechselbaren Mundstücken
für Nieten



Ø mm	2,4	3	3,2	3,2	4,8
Aluminium	•	•	•	•	•
Stahl	•	•	•	•	•
Edelstahl	•	•	•	•	•

1740B 280	L mm	€	1	017400280
	280	87,50		

Ø mm	2,4	3,2	4,0	4,8	6,4
Aluminium	•	•	•	•	•
Stahl	•	•	•	•	•
Edelstahl	•	•	•	•	•

1740B 330	L mm	€	1	017400330
	330	102,00		

1741B

Nietzange, komplett mit vier auswechselbaren
Mundstücken für Nieten



Ø mm	2,4	3,2	4	4,8	5
Aluminium	•	•	•	•	•
Stahl	•	•	•	•	•
Edelstahl	•	•	•	•	•

1741B	€	1	017410000
	46,50		

1741B/C5

Sortiment mit Nietzange Art. 1741B
und 700 Aluminiumnieten



1741B/C5	€	1	017410025
	145,00		

	Ø mm	L mm	n.
1741RV2,9K	3,0	6	200
1741RV3,2K	3,2	8	200
1741RV3,8K	4,0	10	100
1741RV4K	4,0	12	100
1741RV4,8K	4,8	12	100

415x155x60 mm - 3,1 Kg



1741BP

Nietzange, komplett mit vier auswechselbaren Mundstücken für Nieten



Ø mm	2,4	3,2	4	4,8	5
Aluminium	•	•	•	•	•
Stahl	•	•	•	•	•
Edelstahl	•	•	•	•	•

1741BP € 71,00 1 017410350

1741U

Nietzange, ultrakompakt, mit Kräfteinstellung, komplett mit 4 auswechselbaren Mundstücken für Nieten

3 Klauen: bessere Nietenaufnahme



Ø mm	2,4	3	3,2	4	4,8
Aluminium	•	•	•	•	•
Stahl	•	•	•	•	•
Edelstahl	•	•	•	•	•

1741U € 55,00 1 017410450

1741RV...K

Aluminiumnieten

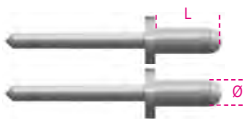

1741RV 2,9K ØxL = 3x6 mm	€ 23,30	1 017410191
1741RV 3,2K ØxL = 3,2x8 mm	24,00	1 017410192
1741RV 3,8K ØxL = 4x10 mm	30,00	1 017410193
1741RV 4K ØxL = 4x12 mm	33,00	1 017410194
1741RV 4,8K ØxL = 4,8x12 mm	41,00	1 017410195

Die angegebenen Preise beziehen sich auf 500 Stück.

1742N

Nietzange für Gewindeeinsätze, komplett mit 4 auswechselbaren Mundstücken und 4 Stiften (1x M3;M4;M5;M6)



1742N € 154,00 1 017420002

	Ø mm	L mm
3	5	11
4	6	11
5	7	13
6	9	17

1742N/KR

Satz an 4 Ersatzstiften für Art. 1742N



M3	€ 66,00	1 017420063
M4	66,00	1 017420064
M5	66,00	1 017420065
M6	66,00	1 017420066

1742R-AL/M...

Gewindenieten aus Aluminium für Art. 1742-1742A-1946KF



1742R-AL M3 ØxL = 5x10 mm M = 3	€ 5,90	1 017420023
1742R-AL M4 ØxL = 6x12 mm M = 4	6,00	1 017420024
1742R-AL M5 ØxL = 7x13 mm M = 5	6,40	1 017420025
1742R-AL M6 ØxL = 9x15 mm M = 6	7,70	1 017420026

Die angegebenen Preise beziehen sich auf 20 Stück

1742R-A/M...

Gewindenieten aus Stahl für Art. 1742-1742A-1946KF



1742R-A M3 ØxL = 5x11 mm M = 3	€ 6,10	1 017420013
1742R-A M4 ØxL = 6x11 mm M = 4	6,20	1 017420014
1742R-A M5 ØxL = 7x13 mm M = 5	6,80	1 017420015
1742R-A M6 ØxL = 9x17 mm M = 6	7,90	1 017420016
• 1742R-A M8 ØxL = 11x17 mm M = 8	7,50	1 017420018
• 1742R-A M10 ØxL = 13x24 mm M = 10	8,90	1 017420020
• 1742R-A M12 ØxL = 12x24 mm M = 12	11,00	1 017420022

Die angegebenen Preise beziehen sich auf 20 Stück
• Die angegebenen Preise beziehen sich auf 10 Stück

1742N/C4

Sortiment mit Nietzange Art. 1742N und 400 Gewindeeinsätzen aus Stahl



1742N/C4 € 345,00 1 017420006

	M	Ø mm	n.
1742R-A/M3	3	5	100
1742R-A/M4	4	6	100
1742R-A/M5	5	7	100
1742R-A/M6	6	9	100

415x155x60 mm - 2,9 kg

1742AN

Nietzange, Kraftmodell, für Gewindeeinsätze, mit 7 auswechselbaren Mundstücken



1742AN € 486,00 1 017420101

	Ø mm	L mm
M 5	7	13
6	9	17
8	11	17
10	13	24

1742AN/KR

Satz an 4 Ersatzstiften für Art. 1742AN



		€		
1742AN/KR M3	M3	45,00	1	017420153
1742AN/KR M4	M4	45,00	1	017420154
1742AN/KR M5	M5	45,00	1	017420155
1742AN/KR M6	M6	45,00	1	017420156
1742AN/KR M8	M8	45,00	1	017420158
1742AN/KR M10	M10	45,00	1	017420160
1742AN/KR M12	M12	45,00	1	017420162

1742AN/C

Sortiment mit Nietzange Art. 1742AN und 80 Gewindeeinsätzen aus Stahl



	€		
1742AN/C	566,00	1	017420106

	M	Ø mm	n.
1742R-A/M5	5	7	20
1742R-A/M6	6	9	20
1742R-A/M8	8	11	10
1742R-A/M10	10	13	10

420x240x80 mm - 2,5 kg

1749

Pistole für Dichtungsmasse Blech, lackiert



	L min mm	€		
1749	340	16,40	2	017490001

1749A

Pistole für Dichtungsmasse, Profi-Modell, Aluminiumrohr



	L min mm	€		
1749A	360	51,50	1	017490010

1749A/RB

Ersatzmundstücke für Art. 1749A

	€		
1749A/RB	1,30	1	017490051

1749A/RT

Verschraubbare vordere Verschlusskappen für Art. 1749A

	€		
1749A/RT	2,70	1	017490052

1749AC

Hochdruckpistole für chemische Befestigungen



	L min mm	€		
1749AC	360	45,50	1	017490005

1750

Hebelfettpressen

Nutzbar mit Kartuschen Art. 1750CG oder mit losem Fett



	1750CG cc	cc	L mm	€		
	400	500	380	51,00	1	017500500
	600	750	450	59,50	1	017500750

1750R/1 - 1750R/2

Flexible Ersatzdüsenrohre aus Nylon



	L mm	€		
1750R/1	310	8,10	2	017500030
1750R/2	410	9,10	2	017500040

1750RC

Starres Düsenrohr, gebogen



	L mm	M mm	€		
1750RC	150	10x1	6,70	2	017500050

1750RT

Ersatzmundstück mit 4 Befestigungskralen "Hydraulic"



	M mm	€		
1750RT	10x1	6,00	5	017500110

1750RP/1 - 1750RP/2

Mundstücke für flache Schmiernippel

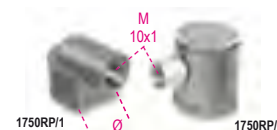

	Ø mm	M mm	€		
1750RP/1	16	10x1	14,70	2	017500115
1750RP/2	22	10x1	33,00	2	017500120

1750CG

Fettkartuschen für Art. 1750



	cc	€		
	400	17,90	18	017500140
	600	22,40	18	017500160

1750KG10

Hebelschmierer 10 kg,
mit Hochdruckschlauch 2 m

Mit Drehverschraubung, damit Schlauch nicht gequetscht wird.
Pumpkörper aus Aluminiumdruckguss mit Entlüftungsventil

3 einstellbare Druckstufen
-4 gr 275 bar
-7 gr 206 bar
-9 gr 137 bar



1750KG10 € 229,00 1 017500100

1750TA

Selbstsperrender Hochdruck-Schmierkopf mit 6 Nadeln

Nach erfolgter Positionierung bleibt er in Achse und am Schmiernippel verbunden, braucht nicht wie normale Köpfe gehalten zu werden
Leichtes Trennen auch mit unter Druck stehendem Kopf.
Gewinde M10x1: Geeignet für alle Typen von Schmiernippeln: elektrisch, pneumatisch, manuell usw.
Beständig bis zu 550 bar



1750TA € 53,50 1 017500111

1750TLA

Selbstsperrender Hochdruck-Schmierkopf mit 6 Nadeln, lange Ausführung

· Nach erfolgter Positionierung bleibt er in der Achse und am Schmiernippel verbunden
· Leichtes Trennen auch mit unter Druck stehendem Kopf.
· Gewinde M10x1: Geeignet für alle Typen von Schmiernippeln: elektrisch, pneumatisch, manuell usw.
· Beständig bis zu 550 bar

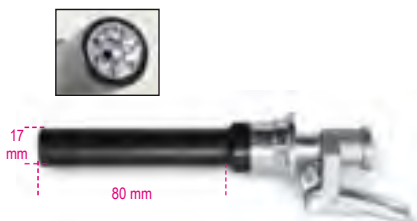

1750TLA € 72,00 1 017500112

1750M

Mini-Fettpresse

- Mit Mikrodüse
- Besonders für Druckluftwerkzeuge geeignet



1750M	cc	D mm	L mm	€	U	W
	100	43	145	26,50	1	017500025

1750M3

Mini-Fettpresse mit 3 Düsen

- Mit drei austauschbaren Düsen: 0.7 - 1.0 - 1.4 mm
- Besonders geeignet für die Schmierung von Druckluftwerkzeugen
- Nutzbar mit losem Fett
- Geeignet für die Verwendung von Fetten bis NLGI 2



1750M3	cc	Ø mm	L mm	€	U	W
	85	42	160	35,00	1	017500003

1751CR

Metallöler mit Pumpe,
starres Spritzrohr



cc	D mm	L mm	€	U	W
200	62	140	19,00	4	017510202
300	75	140	20,00	4	017510203
500	85	140	21,00	4	017510205
700	100	140	23,00	2	017510207
1000	100	140	25,00	2	017510210

1751N

Metallölkannen mit Pumpe,
biegsames Düsenrohr



cc	D mm	L mm	€	U	W
200	62	140	19,10	4	017510020
300	75	140	20,80	4	017510030
500	85	140	21,80	4	017510050
700	100	140	23,70	2	017510075
1000	100	140	26,00	2	017510100

1752

Kunststoffölkannen mit Pumpe,
starres Düsenrohr



cc	D mm	L mm	€	U	W
200	67	140	12,50	4	017520002
300	77	140	13,40	4	017520003
500	95	140	14,10	4	017520005

1754

Kunststoffölkannen mit Pumpe,
biegsames Düsenrohr



cc	D mm	L mm	€	U	W
150	60	130	11,40	5	017540015
250	65	130	12,80	5	017540025

1755C

Kunststofföler,
gebogenes Spritzrohr



cc	L mm	A mm	€	Hand icon	Computer icon
125	110	46	6,00	5	017550112
250	110	60	8,00	5	017550125
500	110	74	9,00	4	017550150

1756

Tropfenöler in Kugelschreiberform

Geeignet für die Verwendung mit Mineralölen



cc	L mm	€	Hand icon	Computer icon
5	140	27,00	2	017560001

1756B

Ölspritze

- Mit rutschfester Rändelung
- Betriebstemperatur: -10 °C ÷ +60 °C
- Minimale Öldichte SAE 10



cc	L mm	€	Hand icon	Computer icon
500	280	26,00	2	017560220

1756C

Ölspritze 200 ml
aus Polypropylen

- Eignet sich auch für Bremsflüssigkeit
- Doppelte Dichtung aus EPDM
- Betriebstemperatur: +0 °C ÷ +50 °C
- Nicht geeignet für Kraftstoffe und Mineralöle
- Minimale verwendbare Öldichte: ISO 150, SAE 90 (Getriebeöl), SAE 40 (Motorenöl)



1756C	€	Hand icon	Computer icon
	41,00	1	017560502

1756D

Ölspritze 1500 ml
aus Polypropylen

- Doppelte Dichtung aus NBR
- Betriebstemperatur: +0 - +50 °C
- NICHT geeignet für Kraftstoffe

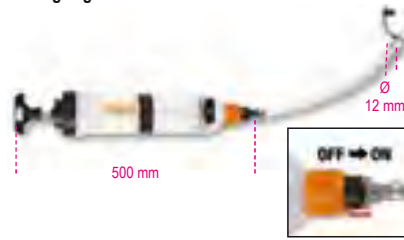

1756D	€	Hand icon	Computer icon
	93,00	1	017560515

1756E

Saug- und Druckspritze, mit Benzin kompatibel



1756E	€	Hand icon	Computer icon
	49,00	1	017560610

1756G

Dieselspritze
Fassungsvermögen 1,5 l

- Verwendbar für:
- Befüllen Dieselfilter
 - Befüllen Tank Cerina Dieseladditiv



- Im Satz inbegriffen:
- 2 Leitungen mit Schnellanschlüssen für Dieselleitungsverbindung
 - 2 Steck-Schnellanschlüsse aus Metall
 - 1 konischer Adapter für Gummileitungen

1756G	€	Hand icon	Computer icon
	144,00	1	017560615

1756C-20R

O-Ring Paar für Spritzen Art. 1756C

1756C-20R	€	Hand icon	Computer icon
	5,40	1	017560503

1756D-20R

O-Ring Paar für Spritzen Art. 1756D

1756D-20R	€	Hand icon	Computer icon
	9,00	1	017560516

1757

Batteriennachfüllbehälter



cc	D mm	€	Hand icon	Computer icon
250	60	4,40	4	017570002
500	75	5,20	4	017570004
1000	90	7,00	2	017570006

1757A

Batteriezellenfüller



cc	€	Hand icon	Computer icon
2000	51,50	1	017570020

1758

Selbstanpassender Trichter

Besonders für Fahrzeuge ohne Tiefe innerhalb der Einfüllschraube geeignet



1758	€	Hand icon	Computer icon
	64,00	1	017580020

1758ADB-D

Trichter mit Rückschlagventil für AdBlue®
mit gerader Kupplung



1758 ADB-D	€	Hand icon	Computer icon
	42,00	1	017580050

1758ADB-45°

Trichter mit Rückschlagventil für AdBlue® mit 45°-Kupplung



1758 ADB-45 Max 1 € 44,50 1 017580060

1758A

Trichter mit Rückschlagventil mit Schnellkupplung, Ø 38 mm Für Fahrzeuge der VW Gruppe



1758A € 98,50 1 017580010

1758B

Trichter mit Rückschlagventil mit Schnellkupplungen Besonders geeignet für Fahrzeuge der Gruppe VAG



1758B € 43,50 1 017580030

1758B-1,6

Trichter mit Rückschlagventil, 1600 ml, mit Schnellkupplungen Schnellkupplungen für Fahrzeuge der VAG Gruppe



1758B-1,6 H1 mm 125 H2 mm 100 Ø mm 155 € 48,00 1 017580033

1758B-RNT

Schnellanschluss Rückschlagventil für Trichter Art. 1758B - 1758B-1,6

Für Motor Renault 1.5 dCi



1758B-RNT € 30,50 1 017580035

1758B/K5

Kit Schnelladapter mit Rückschlagventil für Trichter Art. 1758B - 1758B-1,6

Kitinhalt:

- 1 Adapter für Motoren 1.5 dCi Renault, Dacia, Nissan
- 1 Adapter für Motoren 1.5/1.6 dCi Renault, Dacia, Nissan
- 1 Adapter für Dieselmotor 3.0 BMW
- 1 Adapter für Benzinmotoren 1.5/2.0 der VAG-Gruppe
- 1 Adapter zum Anschluss an den Trichter mit Ventil



1758B/K5 € 123,00 1 017580040

1758RD

Einfülltrichter mit Schnellkupplungen für Kühlmittel



H mm 248 Ø mm 172 € 133,00 1 017580070

1758S

Wandhalterung für Einfülltrichter Art. 1758 und Schnellkupplungen



1758S € 99,50 1 017580080

1758LG

Modellierbare Alufolie, gummibeschichtet, für die Kanalisierung der Flüssigkeiten



L mm 365 H mm 168 € 55,00 1 017580006

1758M

Trichter



1758M L mm 350 € 16,20 1 017580000

1758R

Gefäße für Flüssigkeiten

Praktische, flexible Tülle, entfernbar



	lt	€		
1758R 1	1	10,20	1	017580201
1758R 2	2	12,30	1	017580202
1758R 3	3	21,70	1	017580203
1758R 5	5	26,50	1	017580205

1758VT

Zylinderkopf Prüfsatz

Schneller Nachweis und Anzeige bei Vorhandensein von Kohlendioxid.



1758VT	€ 209,00	1	017580100
--------	----------	---	-----------

≡ 290x190x50 mm - 1kg

1758VT/L

Kontrastflüssigkeit für Zylinderkopfprüfung



1758VT/L	€ 59,50	1	017580101
----------	---------	---	-----------

1759

Optischer Kühlflüssigkeits-, Batteriesäure-, Scheibenwasser- und AdBlue®-Prüfer
Lieferung im festen Etui

Automatische Temperaturkompensation
Batteriesäure: Messintervall von 1,1 bis 1,3 kg/l
Kühlflüssigkeit mit Propylene: von -25°C bis -50°C
Kühlflüssigkeit mit Äthylen: von -25°C bis -50°C
Scheibenwaschflüssigkeit: von -25°C bis -40°C
AdBlue: Prozentuale Harnstoffmessung von 30 % bis 45 %



1759	€ 193,00	1	017590251
------	----------	---	-----------

1759A

Frostschutzprüfer, Glasgehäuse



1759A	L mm 340	€ 81,00	1	017590001
-------	----------	---------	---	-----------

1759B

Säureprüfer, Glasgehäuse



1759B	L mm 280	€ 53,00	1	017590005
-------	----------	---------	---	-----------

1759HD/3

Geräte zur Dichtheitsprüfung der Kühlanlage und Kühlkreisauffüllung

• Ermöglichen die Prüfung des Kreislaufs unter Druck auf eventuelle Leckagen (Rohre, Anschlüsse, Pumpen, Kühler) und schnelle Füllung des Kreislaufs unter Vermeidung von Luftblasenbildung



1759HD/3	€ 680,00	1	017590063
----------	----------	---	-----------

≡ 600x500x140 mm - 6,5 kg

1759HD/RR

Kühlerfüllgerät



1759HD/RR	€ 209,00	1	017590064
-----------	----------	---	-----------

≡ 450x310x110 mm - 2,2 kg



1759LR

Werkzeug zur Kühlanlagenreinigung

Dank der Druckluft ermöglicht der hohe Wasserdruck eine wirksame Reinigung der Kühlanlage

- Inkl. 6 Adapter zum Anschluss an die Kühlanlage
- Betätigungshebel mit Stellungsverriegelung zur Daueranwendung
- Inkl. Schnellwasseranschluss



1759LR L € 1 017590070
 mm 402
 522,00
 390X330X100

1759HD/TRUCK

LKW-Kühlsystem, Test- und Versiegelungswerkzeug



1759HD/TRUCK € 1 017590065
 473,00
 440x330x100 mm - 3 kg

1759TT

Satz 4 Paare Stopfen Turbokreistest verwendbar mit Reifenaufpump pistolen



1759TT € 1 017590300
 251,00
 400x160x100 mm - 1,8 kg

ZERTIFIKATIONSSERVICE ELEKTRONISCHE GERÄTE

Die Zertifizierung von elektronischen Messgeräten wie Multimeter, Stromzange, **Drehzahlmesser und Thermometer** ist unerlässlich in jenen Sektoren oder Anwendungsbereichen, in denen die Genauigkeit und Richtigkeit der Messung auf eindeutige und erkennbare Weise gekannt und kontrolliert werden muss.

Für die Infrarot-Thermometer wird ein Kalibrierbericht bezüglich 4 Punkten (Mindest-, Höchst- und zwei mittlere Punkte) mit Rückfahrbarkeit ENAC ausgestellt.

Beta Utensili S.p.A. bietet auf Anfrage hin den Zertifikationservice. Zur Nutzung dieses Service wenden Sie sich bitte an Ihren Händler.



1760DGT

Automotives Mehrzweck-Digitalmultimeter



TECHNISCHE DATEN
 RPM (Tacho):
 Für 2- und 4-Zylinder Motoren
 RPM4 600 - 4000 U/min
 RPM4 600 - 12000 U/min (x10 U/min)
 RPM2/DIS 300 - 4000 U/min
 RPM2/DIS 300 - 6000 U/min (x10 U/min)
 Dwell-Winkel: 4-8 CYL
 Spannung DC: 400mV-4/40/400/1000V
 Spannung AC: 4/40/400/700V
 Strom DC: 40/400mA-4/20A
 Strom AC: 40/400mA-4/20A
 Widerstand: 400Ω-4/40/400kΩ-4/40MΩ
 Kapazität: 40/400nF-4/40/100μF
 Frequenz: 5/50/500Hz-50/500-10MHz
 Messzyklus: 0,1 - 99,9%
 Pulsierungsamplitude: 1 - 10ms
 Diodentest: Stromtest 0,3mA
 Kontinuität: <150Ω - Stromtest <0,3mA
 Display: LCD kontrastreich, 4 Zeichen, Hintergrundbeleuchtung
 Überspannung: Kategorie II 1000V
 Selbstabschaltung: 30 Minuten
 Stromversorgung: 1.9V Batterie (mitgeliefert)
 Induktivzange (mitgeliefert)
 2 Messspitzen (mitgeliefert)
 Weichetui (mitgeliefert)
 Bedienungsanleitung

1760DGT € 1 017600005
 319,00



1760DGT/2

Automotive Digital-Multimeter, tragbar, mit 2-Kanal-Oszilloskop und Funktionsgenerator



DER KIT BEINHALTET:

- Multimeter Prüfspitzen
- 2 BNC Krokodilstecker für Oszilloskop
- Oszilloskop-Prüfsonde (1X und 10X)
- Batterieladegerät
- Nylonhülle

TECHNISCHE DATEN

Display: Farb-TFT, 2,8"
 Auflösung: 320 x 240 Pixel
 Spannungsversorgung: 100V-240V AC, 50Hz-60Hz; DC INPUT 5V DC-2A
 Akku: 2 x 2600 mAh

SPEZIFIKATIONEN MULTIMETER

Test: Spannung, Strom, Widerstand, Elektrische Kapazität, Dioden und On-Off
 Max. Spannung: 600V AC-DC
 Max. Strom: 10A AC-DC
 Max. Widerstand: 40MOHM
 Max. Elektrische Kapazität: 100uF

SPEZIFIKATIONEN OSZILLOSKOP

Horizontal
 Bandbreite: 40MHz
 Frequenzintervall Abtastung: 250MSa/s (Einzelkanal) - 125MSa/s (Doppelkanal)
 Range SEC/DIV: 5ns/div ÷ 500s/div 1,2,5 sequence
 Vertikal
 Range VOLTS/DIV: 10mV/div÷10V/divat BNC Eingang
 Analog auswählbar Bandbreitengrenze, typisch: 20MHz
 Niederfrequenzantwort (-3db): ≤10Hz a BNC
 DC Gain Accuracy: ± 3% für den Abtastmodus Normal oder Mittel, von 10V/div bis 10 mV/div
 Trigger
 Typ: Edge
 Mode: Auto, Normal, Single
 Slope: Rising, Falling, Rising, & Falling
 Source: CH1, CH2
 Eingang
 Kopplung: DC, AC oder GND
 Unterstützte Minderungsfaktoren der Sonde: 1X, 10X, 100X, 1000X
 Arbiträrgenerator
 Wellenformfrequenz: Sine (1Hz÷25MHz), Square (1Hz÷10MHz), Ramp (1Hz÷1MHz), EXP (1Hz÷5MHz)
 Weite: 2,5Vpp (50Ω) - 5Vpp (hohe Impedanz)
 Ausgangswiderstand: 50Ω

Abmessungen: 199 x 98 x 40 mm
 Gewicht: 624g

1760DGT/2 € 888,00 1 017600008

1760B

Mehrzweck-Digitalmultimeter



DURCHFÜHRBARE MESSUNGEN

Spannung DC: 200 mV-2/20/200/1000V
 Spannung AC: 2-20/200/700V
 Strom DC: 2/20/200 mA-20 A
 Strom AC: 2/200 mA- 20 A
 Widerstand: 200Ω - 2/20/200 kΩ - 2/20 MΩ
 Kapazität: 2/20/200 nF - 2/200 μF
 Temperatur: -20° + 1000°C/ -4 °F ~ +2000°F
 Frequenz: 20kHz
 Stromversorgung: 1 9V-Batterie (mitgeliefert)

1760B € 206,00 1 017600012

1760/OHM

Multimeter/Megaohmmeter für Hochspannungs-Isolationstest. Effektivwertmessung TRUE RMS



Messbereich	Basispräzision	
Spannung AC/DC: 50mV - 1000V		±0.06% - ±0.1% rdg
Strom AC/DC: 0.01μA - 10A		±0.5% - ±1% rdg
Widerstand: 0.01Ω - 50MΩ		±0.2% - ±2% rdg
Meg OHM: 0.01 - 5000MΩ		±4% rdg. max current 1mA
Kapazität: 5nF - 10mF		±1.5% - ±3% rdg
Frequenz: 50Hz - 100 MHz		±0.02% - ±0.1% rdg
Temperatur: -50°C - +1350°C		±0.5% rdg
Diodentest: 3V dc		
Durchgangstest: <30 Ω		

1760/OHM € 974,00 1 017600025

1760/RMS

Industrie-Digitalmultimeter

EN61010-1
 EN61326-1



Messbereich	Basispräzision
Spannung AC/DC	110 mV - 600 V ±0.8% - ±2% rdg
Strom AC/DC	110 μA - 10 A ±1.5% - ±2% rdg
Widerstand	110 Ω - 40 MΩ ±1.2% - ±2.5% rdg
Kapazität (bis zu 11 mF)	11 nF - 40 mF ±5% - ±10% rdg
Frequenz rdg	1100 Hz - 110 MHz ±1.2% - ±1.5% rdg
Temperatur rdg	-32° C - +1000° C ±3% - ±5%
Diodentest 3V DC ±10 %	rdg
Durchgangstest	<30 Ω -

1760/RMS € 353,00 1 017600020

1760S

Kompakter Digitalmultimeter

Effektivwertmessung TRUE RMS



Durchführbare Messungen:
 DC-Spannung: 200 mV-2/20/200/600V
 AC-Spannung: 100/600V
 DC-Strom: 200 mA-10 A
 AC-Strom: 0,01-10 A
 Widerstand: 200Ω - 2/20/200 kΩ - 2 MΩ
 Diodentest: 0.4 ÷ 0.7
 Stromversorgung: 2 1,5V-Batterien: 2 1,5V-Batterien, Typ AAA

1760S € 102,00 1 017600022

153x75x42 mm

1760PA/80

AC/DC Stromzange 80A

Spezifisch für Messungen von niedrigen Stromverlust- oder Stromaufnahmewerten an Fahrzeugen

CE



- Range: 1mA-80A AC/DC
- Funktion LED-Taschenlampe, weiß
- Hintergrundbeleuchtetes LCD-Display
- Reset-Funktion
- Hold-Funktion
- Selbstabschaltung
- Spannungsversorgung: 2 Batterien 1,5V Typ AAA

1760PA/80 € 265,00 1 017600002

1760PA/AC

Stromzange und Mehrzweck-Digitalmultimeter

A: AC
V: AC/DC

CE



DURCHFÜHRBARE MESSUNGEN

Spannung DC 400 mV - 4/40/400/600 V
Spannung AC 400 mV - 4/40/400/600 V
Strom AC 40/400/1000 A
Widerstand 400Ω - 4/40/400 kΩ - 4/40 MΩ
Frequenz 5/50/500 Hz - 5/50/500 kHz - 5/10 MHz
Kapazität 40/400 nF - 4/40/100 μF
Temperatur - 20 °C ÷ 1000 °C / - 4 °F ÷ 1832 °F
Stromversorgung: 1 9V-Batterie (mitgeliefert)

1760PA/AC L mm 190 € 217,00 1 017600050

1760PA/AC-DC

Stromzange und Mehrzweck-Digitalmultimeter

A: AC/DC
V: AC/DC

CE



A: AC/DC
V: AC/DC

DURCHFÜHRBARE MESSUNGEN

Spannung DC: 0.1mV ÷ 600V
Spannung AC: 0.1mV ÷ 600V
Strom AC: 0.01A ÷ 1000A
Strom DC: 0.01A ÷ 1000A
Widerstand: 0.1Ω ÷ 40MΩ
Kapazität: 0.001nF ÷ 40 μF
Frequenz: 0.001kHz ÷ 4kHz
Temperatur: -40°C ÷ 1000 °C
-40°F ÷ 1832°F

1760PA/AC-DC € 394,00 1 017600000

1760PA/AC-DC2000

Stromzange mit Digitalmultimeter und Bluetooth-Verbindung

TRUE RMS Funktion bei AC-Messungen

A: AC/DC
V: AC/DC

CE



Durchführbare Messungen:

- DC-Spannung: 0.1mV ÷ 1000V
- AC-Spannung: 0.1mV ÷ 1000V
- AC-Strom: 0.01A ÷ 2000A
- DC-Strom: 0.01A ÷ 2000A
- Widerstand: 0.1Ω ÷ 60MΩ
- Kapazität: 1nF ÷ 6000 μF
- Frequenz: 10kHz ÷ 20kHz
- Temperatur: -20 °C ÷ 1000 °C - 4 °F ÷ 1832 °F
- Stromversorgung: 3 1,5V-Batterien Typ AA (mitgeliefert)
- Bluetooth-Verbindung (Version 4.0)

H mm 300 L mm 110 P mm 43 € 776,00 1 017600003

380x280x100 mm - 1,78 kg

1760DGT-R3

Ersatzprüfspitzen für Mehrzweck-Digitalmultimeter und Stromzangen



1760DGT-R3 € 27,50 1 017600603

1760/RSE

Signalmelder

Ermöglicht die Prüfung der Spannungsversorgung von Bauteilen wie: Common Rail Elektroinjektoren, Benzin/LPG-Elektroinjektoren, piezoelektrische Injektoren Durchflussmengenmagnetventile/Magnetventile AGR, Zündspulen und weitere Bauteile

CE



Zur Durchführung der Diagnose der einzelnen Bauteilen der elektrischen Anlage reicht es, die Sonde dem zu prüfenden Bauteil zu nähern.

In Systemen mit durch vom Steuergerät gesteuerten elektromechanischen/elektronischen Bauteilen ermöglicht das Gerät die Prüfung in folgenden Fällen:

- das Steuergerät steht unter Spannung und führt die Ansteuerung durch
- die Verkabelung des Steuergerät zum Bauteil ist funktionstüchtig
- das zu prüfende Bauteil ist nicht unterbrochen
- das Bauteil ist nicht kurzgeschlossen
- das Bauteil ist elektronisch in Betrieb

1760/RSE € 551,00 1 017600170



1760/TC2

Digital-Drehzahlmesser zum Messen auf Abstand und mit Kontakt



TECHNISCHE DATEN

- Zur Messung von:
 - Berührungsloser Drehung (U/min - RPM)
 - Drehung (U/min - RPM) und Lineargeschwindigkeit (m/min oder ft/min) bei Kontakt
- LCD-Display, 5-stellig
- Maßstab:
 - Messen auf Abstand 2,5÷99.999 U/min
 - Messen mit Kontakt 0,5÷19.999 U/min
 - Lineargeschwindigkeit 0,05÷1.999,9 m/min
- Frequenz: 0,8 Sek.
- Stromversorgung: 4 1,5V-Batterien (Typ AA) oder 6V-Versorgerer (nicht im Lieferumfang enthalten)
- Komplett mit:
 - Adapter zum Messen mit Kontakt;
 - 2 Gummispitzen, Buchsen;
 - 1 Gummispitze, Stecker;
 - 1 Rädchen für lineare Vermessungen;
 - reflektierenden Etiketten;
 - Handbuch
 - Etui aus Kunststoff

1760/TC2	L mm 230	H mm 74	€ 275,00	1	017600161
----------	----------------	---------------	-------------	---	-----------

1760R/TC2

Reflektierende Etiketten für Art. 1760/TC2



1760R/TC2	€ 24,40	1	017600561
-----------	------------	---	-----------

1760K

Distanz-Wechselstromspannungsmesser mit Mini-LED-Leuchte

Erfassungsbereich: 200-1000Vac 50/60Hz
CAT III-1000V
Funktioniert mit 2 Batterien AAA (inbegriffen)



1760K	€ 44,50	1	017600140
-------	------------	---	-----------

1760PT

Spannungs- und Durchgangsprüfgerät 12-690V AC/DC

- Funktionen:
- Durchgangsprüfung
 - Phasenumdrehung
 - Phasensuche
 - LED-Taschenlampe



1760PT	€ 177,00	1	017600150
--------	-------------	---	-----------

1760/IR500

Infrarot-Digitalthermometer mit doppeltem Laserpoint

nicht zur Messung der Körpertemperatur geeignet



TECHNISCHE DATEN

Temperaturmessbereich: -50 ÷ 500 °C (-22 ÷ 932 °F)
Displayauflösung: 0,1
Emissionsgrad: 0,1 ÷ 1 regulierbar
Messgenauigkeit: -50 ÷ 20 °C (+/- 3 °C); 20 ÷ 500 °C (+/-2% oder 2 °C)
Optische Auflösung (D:S): 12:1
Selbstabschaltung: etwa 10 Sekunden
Betriebstemperatur: 0 ÷ 50 °C
Lagerungstemperatur: -20 ÷ 60 °C
Stromversorgung: 1 9V-Batterie

1760/IR500	€ 190,00	1	017600350
------------	-------------	---	-----------

1760/IR1000

Infrarot-Digitalthermometer mit doppeltem Laserpoint

nicht zur Messung der Körpertemperatur geeignet



TECHNISCHE DATEN

Temperaturmessbereich: -50 ÷ 1000 °C (-58 ÷ 1832 °F)
Displayauflösung: 0,1 °C (0,1°F)
Emissionsgrad: 0,1 ÷ 1 regulierbar
Messgenauigkeit: -50 ÷ 20 °C (+/- 3,5 °C); 20 ÷ 300 °C (+/-1% oder 1 °C); 300 ÷ 1000 °C (+/-1,5%)
Optische Auflösung (D:S): 20:1
Betriebstemperatur: 0 ÷ 50 °C
Lagerungstemperatur: -10 ÷ 60 °C
Stromversorgung: 2 1,5V-Batterien (Typ AAA)

1760/IR1000	€ 313,00	1	017600400
-------------	-------------	---	-----------

1760/IR1600

Infrarot-Digitalthermometer mit Laserpointer

nicht zur Messung der Körpertemperatur geeignet



TECHNISCHE DATEN

Messbereich: -50 °C bis 1600 °C / -58 °F bis 2912 °F
Umschalten: °C/°F
Messgenauigkeit: ±1,5% oder ±2 °C bei 20 °C
Leistung Laser: <1mW
Antwort: 1 Sek.
Emissionsgrad: 0,10-1,0 regulierbar
Abstandsverhältnis: (D:S) 50:1
Betriebstemperatur: 0 °C ÷ 50 °C / 32 °F ÷ 122 °F
Relative Luftfeuchtigkeit: 10% bis 90% RH
LCD-Display mit Hintergrundbeleuchtung
Data-Hold-Funktion
Selbstabschaltung
Stromversorgung: 1 9V-Batterie (mitgeliefert)
Feste Schutzhülle mit Alu-Dreifußständer
Bedienungsanleitung

1760/IR1600	mm 200	mm 115	€ 875,00	1	017600461
-------------	-----------	-----------	-------------	---	-----------



1760LX

Digitaler Luxmeter, tragbar

EN61010-1
EN61326-1

CE



Technische Merkmale:
Messbereich Grundpräzision
Lux-Leuchtkraft 0-200000 ±3%
FC-Leuchtkraft 0-20000 ±3%
Stromversorgung: 1 x 9V

1760LX	L mm 165	€ 120,00	1	017600820
--------	----------------	-------------	---	-----------

1760TMC

Infrarot-Wärmebildkamera

Kompakte Wärmebildkamera für die Temperaturmessung ohne Kontakt, geeignet für Anwendungen im Baugewerbe, Mechanik, elektrische Anlagen und Heizungsanlagen

LCD-Display TFT, 2 Zoll 240x320
Sensor 32x32 Pixel
Erfassungsfrequenz 7Hz
Wärmempfindlichkeit <347mK
Automatische Erfassung der warmen und kalten Punkte
Kamera Bildaufnahme in BMP-Format (maximal 100 Bilder)
Emissionsgrad:
Spannungsversorgung 3 Alkalibatterien AAA
USB-Schnittstelle
IP54
Temperatur von -20 °C ÷ +600 °C
Infrarot Frequenzband 6.5÷14µm
Abstand sichtbare Fusion/IR-Fusion: 0.5; 1; 2m
Alarmfunktion durch Auswahl der zulässigen Höchst- und Mindesttemperatur

CE



1760TMC 600	€ 1.001,00	1	017600710
-------------	---------------	---	-----------

1760WM

Digitaler Anemometer mit Gebläsesensor

EN61010-1
EN61326-1

CE



Technische Merkmale:
Messbereich Grundpräzision
Geschwindigkeit m/s 0,4-30 ±2%
Geschwindigkeit k/n 1,4-108 ±2%
Geschwindigkeit ft/m 80-5900 ±2%
Geschwindigkeit mil/h 0,8-58 ±2%
Volumenstrom CFM 0-99990 ±0-9,999 ft²
Volumenstrom CMM 0-99990 ±0-9,999 m²
Volumenstrom CMS 0-99990 ±0-9,999 m²

1760WM	L mm 170	€ 96,50	1	017600800
--------	----------------	------------	---	-----------

1761

Drillzange
mit automatischem Rücklauf



L mm 255	€ 77,50	1	017610101
----------------	------------	---	-----------

1761RS/1

Umsteckbare Drillzange
mit automatischem Rücklauf



L mm 220	€ 139,00	1	017610130
----------------	-------------	---	-----------

1762

Lochzange



Ø mm 2-2,5-3 3,5-4-4,5	L mm 210	€ 36,50	2	017620001
---------------------------------	----------------	------------	---	-----------

1763

Klammerzange für Auto-Innenverkleidung



1763	€ 43,00	1	017630001
------	------------	---	-----------

1763G/S500

500 Klammern für Auto-Innenverkleidung



1763G/S500	€ 80,00	1	017630105
------------	------------	---	-----------

1764/K5

Manuelle Nietzange für Kunststoffnieten

geliefert mit Nieten in 4 verschiedenen Größen

Kitinhalt:

- 10 Nieten Ø 5x17,2 mm
- 10 Nieten Ø 5x15,8 mm
- 10 Nieten Ø 6,3x25,2 mm
- 10 Nieten Ø 6,6x17,2 mm



1764/K5	€ 62,00	1	017640001
---------	------------	---	-----------

1764/K5-R

Packung mit 20 Kunststoffnieten
für Art. 1764/K5



1764/K5-R1	5X17,2	€ 15,20	1	017640003
1764/K5-R2	5X15,8	€ 15,20	1	017640004
1764/K5-R3	6,3X25,2	€ 15,20	1	017640005
1764/K5-R4	6,6X17,2	€ 15,20	1	017640006

1765/C24

Werkzeugkästen mit 24 Werkzeugen zum Auszug von Autoradios



1765/C24 € 231,00 1 017650001

1766

Saugheber, Doppelmodell



max kg 50 € 145,00 2 017660001

1766A

Saugheber, Einzelmodell



max kg 30 € 37,00 2 017660005

1766/8

Werkzeugsortiment für Fahrzeugscheiben, 8teilig



1766/8 € 536,00 1 017660100

1766ER

Fenster-Trim-Abzieher mit Griff

Ermöglicht das mühelose Entfernen vom Fenster-Trim ohne die Gefahr von Beschädigungen



1766ER € 26,50 1 017660501

1766ER/VW

Fenster-Trim-Abzieher mit niedrigem Profil

Besonders geeignet für Fenster-Trims der VAG-Gruppe mit begrenztem Greifraum

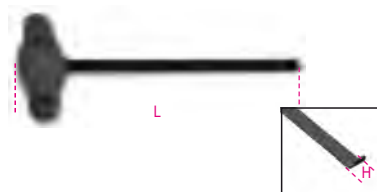

L mm 215 H mm 4 € 18,60 1 017660510

1766L

Hebeleisen für Autoscheiben



1766L € 60,00 1 017660015

1766LI

Hebeleisen zum Einfügen Kabel Scheibenschneider

Scharfe Kanten für Schneiden des Dichtstoffs

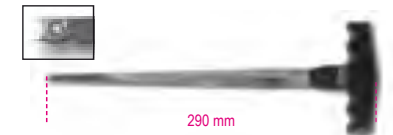

1766LI € 21,50 1 017660016

1766I

Griffe für Stahlkabel Art. 1766G

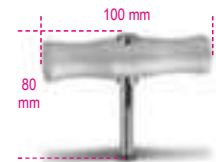

1766I € 58,50 2 017660020

1766G

Stahlkabel für Scheiben

Quadrat Querschnitt



50 m € 52,00 1 017660025

1766T

Stahlkabel für Scheiben

Dreieckiger Querschnitt



50 m € 60,00 1 017660026

Beta

1767A

Teleskopstange

- Ausgelegt für das Abstützen von Motorhauben und Heckklappen mit Ablasskolben
- Verwendbar zum Blockieren der Pedale



L mm
640 ÷ 1090 € 81,50 1 017670000

1767B

Kit Pedal- und Lenksperr

Dank der Einstellung mit Pistole können bei Beschleunigung des Fahrzeugs genaue Werte eingestellt werden.



1767B € 175,00 1 017670100

490x285x95 mm - 2,4 kg

1767PMC

Kunststoffschale für Kleinteile, magnetisch, rund



1767PMC € 26,00 1 017670020

1767PMR

Kunststoffschale für Kleinteile, magnetisch, rechteckig



1767PMR € 52,00 1 017670010

1768

Plattform aus Aluminium

Mit rutschfestem Material beschichtete Oberfläche
Max. Tragfähigkeit: 200 kg



L mm L1 mm H mm € 225,00 1 017680010

1770

Cutter, extraflach, mit 2 Ersatzklingen geliefert



1770 L mm A mm € 19,60 10 017700001

1770A

Cutter mit automatischer Klingensperre, mit 3 Klingen



1770A L mm A mm € 7,40 10 017700025

1770RL

Abbrechbare Klingen, 9 mm breit, 10 Stück, für Cutter Art. 1770, 1770BM und 1770A

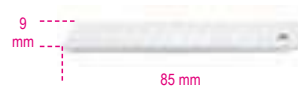

1770RL € 6,60 5 017700010

1770BM

Cutter, 9 mm, mit 6 Ersatzklingen



1770BM L mm A mm € 15,00 10 017700050

1771

Cutter, 18 mm, mit 3 Klingen geliefert



1771 € 11,20 10 017710000

1771BM

Cutter, mit 6 Ersatzklingen geliefert



1771BM L mm A mm € 24,30 10 017710050

1771HD

Cutter 18 mm geliefert mit 6 Klingen

- Automatisches Laden der Klinge
- Automatisches Klingensperre-Schraubsystem



1771HD L mm A mm € 27,50 5 017710100

1771RL

Abbrechbare Klingen, 18 mm breit, 10 Stück, für Cutter Art. 1771, 1771BM, 1771HD



1771RL € 9,40 5 017710010

1772M

Cutter mit Sicherheits-Klappklinge geliefert mit 4 Klingen

- Klinge mit automatischem Federrückzug
- Körper aus Druckgusslegierung
- Im Griff integrierter Enthefter



1772M L mm A mm € 22,20 5 017720040

1772R

Messer mit einziehbarer Trapezklinge, mit 5 Klingen geliefert



	L mm	A mm	€	5	017720006
1772R	125	18	20,50		

1772H

Sicherheitsmesser mit einziehbarer Klinge, mit 2 Klingen geliefert

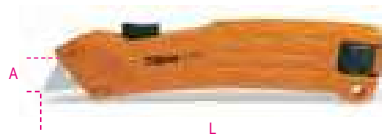

	L mm	A mm	€	5	017720029
1772H	170	18	21,60		

1772RL/2

Gerade Klingen, lang, 10 Stück, im Etui, für Messer 1772H, 1772M, 1772R, 1774, 1777BMT, 1777T

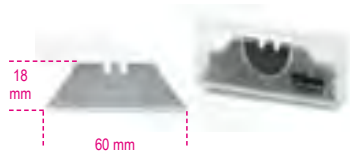

	€	5	017720017
1772RL/2	5,30		

1773A

Cutter



	L mm	A mm	€	10	017730000
1773A	180	25	21,60		

1773RL

Abbrechbare Klingen, 25 mm breit, 10 Stück, für Cutter Art. 1773A



	€	5	017730015
1773RL	21,20		

1773S

Sicherheits-Cutter mit runder Klinge

- Hauptklinge, Ø 28 mm
- Sekundärklinge zum Schneiden von Folien
- Aufhängeloch



	L mm	A mm	€	1	017730100
1773S	190	28	11,00		

1773S/RL

3 runde Klingen, Ø 28 mm für Cutter 1773S



	€	5	017730110
1773S/RL	5,00		

1774

Schaber mit Klingenschutz



	L mm	L1 mm	€	5	017740001
1774	155	60	5,20		

1774A

Schaber Griff aus Bimaterial



	L mm	A mm	€	1	017740011
1774A	300	40	15,70		

1774A/RL

Klingen, 10 Stück, für Schaber Art. 1774A und Art. 1774S

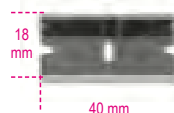

	€	1	017740511
1774A/RL	7,50		

1774S

Schaber für Aufkleberentfernung



	A mm	L mm	€	2	017740021
1774S	40	100	8,50		

1777BM

Kabelklappmesser mit Aussparung zum Abisolieren von Kabeln, Klinge aus Edelstahl



	L mm	L1 mm	A mm	€	5	017770100
1777BM	190	80	16	14,10		

1777T

Klappmesser mit gerader Klinge aus Edelstahl, mit 5 Ersatzklingen geliefert



	L mm	A mm	L1 mm	€	5	017770030
1777T	160	19	65	31,00		

1777BMT

Klappmesser mit gerader Klinge 4 regulierbare Klingentiefen 4; 9.5; 15.5; 21.5 mm mit 3 Klingen geliefert



	L mm	L1 mm	A mm	€	5	017770050
1777BMT	170	80	19	33,00		

1778AN

Klappmesser, Klinge aus Edelstahl, leichter Griff aus eloxiertem Aluminium • mit Etui



	L mm	A mm	L1 mm	€	5	017780065
1778AN	204	26	84	38,00		

1778AX

Klappmesser
Zackenklinge aus Edelstahl,
Griff aus Aluminium,
mit praktischer Zackenöffnung,
• im Etui



1778AX	L mm	A mm	L1 mm	€	5	017780026
	189	26	80	41,50		

1778BS

Klappmesser
mit doppelter Sicherheit,
gezackte Klinge aus rostfreiem Stahl,
Carbon-Look-Oberfläche

• Im Etui



1778BS	L mm	A mm	L1 mm	€	10	017780035
	200	29	85	42,00		

1778CM

Tarn-Klappmesser,
Klinge aus gehärtetem Stahl,
mit Etui



1778CM	L mm	A mm	L1 mm	€	5	017780099
	195	24	80	39,00		

1778M7

Mini-Klappmesser,
Klinge aus Edelstahl,
Griff mit Glasfasereinsätzen
• mit Etui



1778M7	L mm	A mm	L1 mm	€	5	017780015
	163	24	68	33,50		

1778P

Klappmesser,
Klinge und Griff aus Edelstahl und Aluminium,
mit Drucktaste zum Öffnen
• im Etui



1778P	L mm	A mm	L1 mm	€	5	017780088
	193	29	72	44,50		

1778SCL

Klappmesser in Soft-Carbon-Look-Optik,
Klinge aus gehärtetem Stahl
Mit Etui geliefert



1778SCL	L mm	A mm	L1 mm	€	5	017780089
	180	22	78	37,00		

1778SOS

Auto-Notfallmesser
mit Glasbruchhammer-
und Sicherheitsgurtschneiderfunktion,
mit Etui



1778SOS	L mm	A mm	L1 mm	€	5	017780080
	205	25	85	39,00		

1778V18

Klappmesser,
Griff aus Aluminium
• mit Etui



1778V18	L mm	A mm	L1 mm	€	5	017780018
	195	25	85	37,00		

1778X

Messer für die Schiffswartung, aus Edelstahl,
Aluminiumgriff,
mit Etui



1778X	L mm	L1 mm	A mm	€	2	017780050
	185	85	25	36,00		



1778MT - MULTITOOL

Das Multifunktionswerkzeug von BETA unterscheidet sich von ähnlichen Artikeln auf dem Markt durch jene Merkmale, die seine BETA-Herkunft kennzeichnen: Zangen von unvergleichlicher Qualität, Verwendung von ausgesuchten Materialien und hoher technologischer Gehalt. **11 Einsätze** mit den gängigsten Geometrien auf dem Markt machen diesen Artikel ideal für jede Umgebung und Arbeitsbedingung, vom Campen zur Nautik, von der Jagd zum Heimwerken.



22 FUNKTIONEN

11 Einsätze **100-mm-Lineal - 4-Zoll-Lineal**

1784 Scheren, schwere Ausführung



L mm	€	U	U
175	26,00	2	017840017
200	34,50	2	017840020
250	46,00	2	017840025
300	62,00	2	017840030

1800/100 Hubkissen (Max. 100 kg)

- anheben-nivellieren
- Türen und Flügel blockieren



A mm	B mm	S mm	€	U	U
160	150	2+55	69,50	3	018000000

1778MT Multifunktionswerkzeug mit Einsätzen und Etui

9 Werkzeuge
22 Funktionen



L mm	L1 mm	€	U	U
180	115	118,00	1	017780055

1781 Drahtschere mit langen, spitzen Schneiden

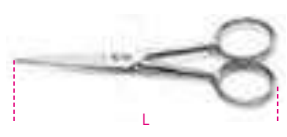

L mm	€	U	U
1781 132	21,70	2	017810001

1783 Scheren, leichte Ausführung



L mm	€	U	U
1783 215	18,10	5	017830021
1783 240	20,20	5	017830024



BELEUCHTUNG

Die Familie Beleuchtung umfasst eine breite Produktpalette, die die Ansprüche aller Benutzer erfüllt, angefangen mit der Inspektion von kleinen Leitungen bis hin zur Beleuchtung von großflächigen Arbeitsflächen.

TASCHENLAMPEN

Das neue attraktive Design, die technischen Verbesserungen und das breite Angebot von Abmessungen ermöglichen die geeignete Taschenlampe in Bezug auf die Leuchtkraft, die Autonomie und die Leistungen auszuwählen.

LAMPEN UND STRAHLER

Dank der Verbesserungen der LED-Technologie, der erhöhten Dauer der Batterie, der Reduzierung der Ladezeiten, des besonderen Augenmerks auf die Materialien und der konstanten Entwicklung innovativer Lösungen, stellen die Beta Lampen eine optimale Verbindung von Design, Bedienerfreundlichkeit und Leistungen dar.

Eine komplette Produktauswahl, um ein optimales Arbeiten des Profis zu garantieren, in jeder Branche und unter jeder Bedingung.

WIRELESS

Die neue kabellose Technologie ermöglicht das Aufladen der neuesten Leuchten und Lampen über eine einzige Ladestation 1839BRW.

Durch die neue Basis 1839BRW ist es möglich, die neuesten Baustrahler und Lampen gleichzeitig und kabellos

aufzuladen.

Im Weiteren können Sie dank der herausnehmbaren Halterung auch Ihr Mobiltelefon aufladen.

CRI - Color Rendering Index

CCT - Correlated Color Temperature



SCHEINWERFER

ITEM	LUMEN	BATTERIE	AUFLADBAR LEBENSDAUER	Batterielaufzeit	IP/IK	CCT	CRI
1837C/2100	500 - 1000 - 2100	Li-Ion 11.1V; 4400 mAh	4.0h	9 - 2.5h	IP65 - IK07	6500K	80+
1837C/4300	1100 - 2100 - 4300	Li-Ion 11.1V; 5200 mAh	4.0h	6 - 1.5h	IP65 - IK07	6500K	80+
1837M	500 - 1000 - 2000	Li-Ion 11.1 V; 5200 mAh	3.5h	2 - 8h	IP65 - IK07	2700-3500-4500-5500-6500K	96+
1838FLASH	360 - 720	Li-Ion 7.4 V; 4000 mAh	4.0h	4 - 8h	IP65	6300K	-
1838POCKET	160 - 400 - 800	Li-Ion 3.7 V; 2600 mAh	4.0h	3 - 9h	IP65	6500K	80+

LAMPEN

ITEM	LUMEN	BATTERIE	AUFLADBAR LEBENSDAUER	Batterielaufzeit	IP/IK	CCT	CRI
1838/11LED	320	Li-Ion 3.7V; 4200 mAh	4.0h	4h	IP65	6500K	
1838AM	60 - 700 120 (spot)	Li-Ion 3.7V; 2600 mAh	4.0h - USB-C	2.5 - 16h 10h (spot)	IP54 - IK07	6500K	80+ 70+
1838COB	100 - 200 75 (spot)	Li-Ion 3.7V; 1600 mAh	3.0h	3-6h 4h (spot)	IP65	6000K	80+
1838P	80 - 50	Li-Ion 3.7V; 700 mAh	2.5h	4h	IP20	6000K	80+
1838SLIM	100 - 200 180 (back) 80 (spot)	Li-Ion 3.7 V; 700 mAh	2.5h - USB-C	2 - 4h 2h (back) 3h (spot)	IP54 - IK07	6500K	80
1838UV	75 - 150	Li-Ion 3.7V; 1600 mAh	3.0h	3h	IP20	6000K	80
1838SW	250 - 500 - 1000	Li-Ion 3.6V; 3350 mAh	4.5 - 6.5h	3 - 7h	IP65 - IK07	6500K	80+
1838E	500 - 1000 - 2000	Li-Ion 3.6V; 3350 mAh	4.5 - 6.5h	3 - 9h	IP20 - IK07	5500K	80+

STIRNLAMPEN

ITEM	LUMEN	BATTERIE	AUFLADBAR LEBENSDAUER	Batterielaufzeit	IP/IK	CCT	CRI
1836B	125 - 250	Li-Ion 3.8V; 1600 mAh	3.0h	5h	IP65 - IK07	6000K	80+
1836AW	30 - 200 - 400	Li-Ion 3.7V; 1500 mAh	2.5h	4-18h	IP65 - IK07	6500K	80+

TASCHENLAMPEN

ITEM	LUMEN	BATTERIE	AUFLADBAR LEBENSDAUER	Batterielaufzeit	IP/IK	LEUCHTWEITE
1833XS/1	100	1 x AAA	-	5h	IP66	85m
1833XS/2	200	2 x AAA	-	10h	IP66	112m
1833S	500	2 x AA	-	10h	IP66	140m
1833M	700	3 x AAA	-	7.5h	IP66	170m
1833L	1100	3 x AA	-	8.5h	IP66	330m
1833L/USB	1200	Li-Ion 3.7 V; 2600 mAh	3.0h - USB-C	3.0h	IP66	230m
1833XSW	80 - 250	Li-Ion 3.7V 2600mAh	2.0 h	2.0-8.0h	IP54 - IK07	
1833MW	5 - 30 - 400 - 1000	Li-Ion 3.7V; 2600 mAh	4.0 - 6.0 h	2.0-200.0h	IP68 - IK07	
1833XL	1500	3xD	-	22h	IP66	290m
1837F	500	3 x AA	-	14.5h	IP66	125m
1837F/USB	600	Li-Ion 3.7 V; 2900 mAh	4.0h - USB-C	10h	IP66	280m

1833L/USB

LED-Taschenlampe, wiederaufladbar, leuchtstark, aus robustem eloxiertem Aluminium, bis zu 1200 Lumen

- Verstellbarer Leuchtkegel
- 3 Leuchtstärken
- Batterielaufzeit: 3.0h
- IP66
- Leuchtweite: 230 m
- Batterie-leer-Anzeige (<15%)
- Aufladung mit USB-C Anschluss
- Ladegerät nicht im Lieferumfang enthalten

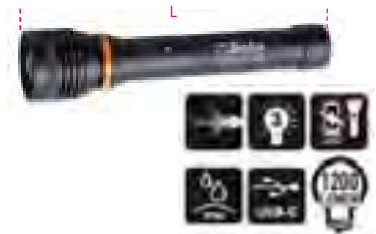

L mm 240 € 136,00 1 018330054

1833RB-L/USB

Ersatzbatterie für Art. 1833L/USB

1833RB-L/USB € 62,50 1 018330975

1833XS/1

LED-Inspektionslampe, aus robustem eloxiertem Aluminium

- 100 Lumen
- Verstellbarer Leuchtkegel
- 1xAAA Batterie (nicht im Lieferumfang enthalten)
- IP66
- Batterielebensdauer: 5.0h
- Leuchtweite: 85 m



L mm 92 € 23,60 3 018330000

1833XS/2

LED-Inspektionslampe, aus robustem eloxiertem Aluminium

- 200 Lumen
- Verstellbarer Leuchtkegel
- 2xAAA Batterien (nicht im Lieferumfang enthalten)
- IP66
- Batterielebensdauer: 10.0h
- Leuchtweite: 112 m



L mm 133 € 26,00 3 018330001

1833XSW

LED-Inspektionslampe, kabellos aufladbar

- 2 Leuchtstärken: LED SMD, 250 - 80 Lumen
- Aufladbare Batterie: 3,7V 700 mAh., 2.59 Wh Li-Ion
- Zwei Lademodi:
- kabellose Ladestation 1839BRW
- Ladegerät mit USB-C-Anschluss
- Akkuladendauer:
- 2h mit kabelloser Ladestation
- 2h mit Ladegerät
- Akkulaufzeit: 2-8h
- Ladestandsanzeiger mit 3 LEDs
- Magnete am Boden und an der Rückseite
- Gürtelclip
- IP54
- IK07
- Inkl. USB-C-Kabel



L mm
145 € 55,50 1 018330011

1833S

LED-Taschenlampe, leuchtstark, aus robustem eloxiertem Aluminium, bis zu 500 Lumen

- Verstellbarer Leuchtkegel
- 2 Leuchtstärken
- 2xAA Batterien (nicht im Lieferumfang enthalten)
- Batterie-leer-Anzeige (<15%)
- Batterie-lebensdauer: 10.0h
- IP66
- Leuchtweite: 140 m



L mm
150 € 44,50 1 018330002

1833M

LED-Taschenlampe, leuchtstark, aus robustem eloxiertem Aluminium, bis zu 700 Lumen

- Verstellbarer Leuchtkegel
- 2 Leuchtstärken
- 3xAAA Batterien (nicht im Lieferumfang enthalten)
- Batterie-leer-Anzeige (<15%)
- Batterie-lebensdauer: 7.5h
- IP66
- Leuchtweite: 170 m



L mm
162 € 55,50 1 018330003

1833MW

LED-Taschenlampe, leuchtstark, kabellos aufladbar

- 4 Leuchtstärken: LED SMD, 1000 - 400 - 30- 5 Lumen
- Aufladbare Batterie: 3,7V 2600 mAh., 9.62 Wh Li-Ion
- 2 Lademodi:
- kabellose Ladestation 1839BRE
- Ladegerät mit USB-C-Anschluss
- Akkuladendauer:
- 6h mit kabelloser Ladestation
- 4h mit Ladegerät
- Akkulaufzeit: 2-200h
- Ladestandsanzeiger mit 3 LEDs
- Magnet am Boden
- IP68
- IK07
- Inkl. USB-C-Kabel



L mm
160 € 102,00 1 018330013

1833L

LED-Taschenlampe, leuchtstark, aus robustem eloxiertem Aluminium, bis zu 1100 Lumen

- Verstellbarer Leuchtkegel
- 2 Leuchtstärken
- 3xAA Batterien (nicht im Lieferumfang enthalten)
- Batterie-leer-Anzeige (<15%)
- Batterie-lebensdauer: 8.5h
- IP66
- Leuchtweite: 330 m



L mm
196 € 92,00 1 018330004

1833XL

LED-Taschenlampe, leuchtstark, aus robustem eloxiertem Aluminium, bis zu 1500 Lumen

- Verstellbarer Leuchtkegel
- 2 Leuchtstärken
- 3xD Batterien (nicht im Lieferumfang enthalten)
- Batterie-leer-Anzeige (<15%)
- Batterie-lebensdauer: 22.0h
- IP66
- Leuchtweite: 290 m



L mm
300 € 116,00 1 018330005

1836AW

LED-Stirnlampe mit doppelter Lichtemission, kabellos aufladbar

- Doppelte Lichtemission:
- Frontlicht: 3 Leuchtstärken LED COB 30 - 200 - 400 Lumen
- Kopflicht (Spot): LED COB, 400 Lumen
- Wiederaufladbare Batterie: Li-Ion 3.7 V, 1500 mAh, 5.55 Wh
- Mit USB-C-Kabel
- Geliefert mit USB-C-Kabel
- Akkuladendauer: 2,5 h
- Akkulaufzeit:
- Frontlicht: 4-18 h
- Kopflicht (Spot): 4h
- IP 65
- IK 07



1836AW € 83,00 1 018360051

1836B

Wiederaufladbare LED Kopfleuchte, 2 Helligkeitsstufen, mit Ein-/Aus-Sensor

- Berührungsloser Ein-/Aus-Sensor
- Mit USB/Minijack Ladekabel + Ladegerät
- 250 Lumen
- Batterielebensdauer: 3-6 h
- IP65



1836B € 151,00 1 018360200

1837F

Magnet-Gelenk-LED-Lampe LED leuchtstark, aus robustem eloxiertem Aluminium, bis zu 500 Lumen

- Verstellbarer Leuchtkegel
- 2 Leuchtstärken
- Batterien 3xAA (nicht inbegriffen)
- Dauer 14.5 h
- Ladeanzeige
- IP66



L mm
460 € 101,00 1 018370050

1837F/USB

Magnet-Gelenk-LED-Lampe, aufladbar, leuchtstarke LED, aus robustem eloxiertem Aluminium, bis zu 600 Lumen

- Verstellbarer Leuchtkegel
- 2 Leuchtstärken
- Lichtdauer 10.0h
- Akkustandsanzeige <15%
- Aufladen mit USB-C-Anschluss
- Inklusive USB-C-Kabel
- IP66



L mm	€	1	018370060
460	149,00		

1837RB-F/USB

Ersatzbatterie für Art. 1837F/USB

1837RB-F/USB	€	1	018370960
	44,00		

1838POCKET

LED-Taschenlampe, gelenkig, schwenkbar, mit zwei Strahlen, kabellos aufladbar

- Doppelte Lichtemission:
Hauptlicht: LED COB, 3 Leuchtstärken 160 - 400 - 800 Lumen
Kopflicht LED SMD, 250 Lumen
- Leuchtwinkel:
Hauptlicht: 160°
Kopflicht: 18°
- Wiederaufladbare Batterie 3.7V 2600mAh Li-Ion
- 2 Lademodi:
Kabellose Aufladestation 1839BRW
Ladegerät mit USB-C-Anschluss
- Akkuladendauer:
4.5 h mit kabelloser Ladestation
4 h mit Ladegerät
- Akkulaufzeit:
Hauptlicht: 3-9h
Kopflicht (Spot): 4.5 h
- Ladestandsanzeiger mit 3 LEDs
- Um 210° schwenkbar
- Körper aus rutschfestem Gummi
- Magnetischer Boden
- 1 Magnet am Boden
- IP65
- IK07
- Inkl. USB-C-Kabel



L mm	I mm	S mm	€	1	018380080
98	82	39	78,50		

1837C

Aufladbarer LED-Baustrahler

- 3 Leuchtstärken
- Batterieladung: Input: 100-240V AC - 50/60Hz; Output: 15V 1.5A
- Aufladezeit: 4 Stunden
- 3-LED-Ladeanzeige
- 180° schwenkbar
- IP65
- IK07



LxHxI mm	Lm	h	€	1	018370210
220x225x70	2100	2.5	220,00		
	1000	5.0			
	500	9.0			
266x236.6x59	4300	1.5	323,00		1 018370430
	2100	3.0			
	1100	6.0			

1837C/RA2100-4300

Netzteil für LED-Baustrahler Art. 1837C/2100-4300

1837C/RA2100-4300	€	1	018370970
	31,50		

1837M

LED-Baustrahler COLOUR MATCH, aufladbar, mit Farbanpassung, hoher Farbwiedergabeindex (CRI 96+), bis zu 2.000 Lumen

- 3 Leuchtstärken: 500/1.000/2.000 Lumen
- CRI (Farbwiedergabeindex): 96+
- CCT (Farbtemperatur): 2700K/ 3500K/ 4500K/ 5500K/ 6500K
- Batterieladung: Input: 100-240V AC - 50/60Hz; Output: 15V 1.5A
- Ladestecker mit Schnellanschluss
- Aufladezeit: 3,5 Stunden
- Dauer: 8/4/2 h
- Ladeanzeige
- Taste und LED-Farbtemperaturanzeige
- Taste und LED-Leuchtstärkeanzeige
- 180° schwenkbar
- IP65
- IK07



LxHxI mm	Lm	h	€	1	018370450
220x225x70	500	8.0	344,00		
	1000	4.0			
	2000	2.0			

1837M/RA

Netzteil für Baustrahler COLOUR MATCH Art. 1837M



1837M/RA	€	1	018370975
	59,00		

1837S

Teleskop-Stativ für Baustrahler

- aus Metall
- verstellbare Höhe 70+155 cm
- kompatibel mit Art. 1837C und Art. 1838FLASH



h cm	€	1	018370500
70+170	71,50		

1838FLASH

Ultrakompakte aufladbare Lampe als beste Lösung für jede Anwendung.

STARKE UND STETS BEREITE BELEUCHTUNG: mit einer max. Leuchtkraft von 720 Lumen und der Möglichkeit mit Batterie oder mit stets Kabel zu arbeiten

ÜBERALL POSITIONIERBAR:

-auf Flächen: mit rutschfestem Gummi an drei Seiten oder mit 1/4"-Innengewinde für Stativ (Standard Typ Fotoapparat)

-an Metallstrukturen: mit verschraubbarem Magnet oder 360°-Schwenkhaken

KOMPAKT: mit nur 85x100x155 mm Raumbedarf kann die Lampe mühelos auch in der Werkzeugtasche verstaut und auf engem Raum benutzt werden.

ROBUST: Ausgelegt, um den schwersten mechanischen Beanspruchungen standzuhalten. Garantie auf lange Lebensdauer.



IP65

1838FLASH	€	1	018380300
	390,00		

1838RB/FLASH

Ersatzbatterie für Art. 1838/FLASH

1838RB/FLASH	€	1	018380930
	85,00		

1838/11LED

Aufladbare LED-Lampe mit sehr hoher Leuchtkraft
Lithium-Polymer-Batterie

- Kompaktes Gehäuse aus rutschfestem Gummi
- Einfach zu wechselndes Frontglas
- Ausrichtbarer Haken
- Mit Ladestation 110-230 Vac
- 340 Lumen
- Mit LED am Kopf für Beleuchtung in alle Richtungen



1838/11LED € 191,00 1 018380111

1838RA/10-11LED

Ersatznetzteile für Art. 1838/10LED und Art. 1838/11LED

CE

1838RA/10-11LED € 40,00 1 018380903

1838RB/10LED

Ersatzbatterie für Art. 1838/10LED und Art. 1838/11LED

1838RB/10LED € 64,00 1 018380902

1838RR/11LED

Ladestationen für Art. 1838/11LED

1838RR/11LED € 43,00 1 018380914

1838RV/11LED

Ersatzkratzschutzglas für Lampe Art. 1838/11LED



1838RV/11LED € 5,90 2 018380905



1838AM

Wiederaufladbare LED-Inspektionslampe mit doppelter Leuchtkraft, gelenkig und 180° drehbar, mit schwenkbarem magnetischem Boden und Haken

- 2 Leuchtstärken:
Frontlicht: LED COB, 60-700 Lumen, mittels Potentiometers regulierbar
Kopflicht (Spot): LED SMD, 120 Lumen, Ein-/Aus-Schalter
- Wiederaufladbare Batterie 3.6V 2600mAh Li-ion
- Mit USB-C Anschluss
- Geliefert mit Ladegerät 100-240V / 50-60Hz
- Akkuladedauer: 4h
- Akkulaufzeit:
Frontlicht: 2.5-16h
Kopflicht (Spot): 10h
- Ladestandsanzeiger mit 3 LEDs

- Gelenkig und 180° schwenkbar ($\pm 90^\circ$ zur Achse)
- Magnetischer Boden (mit Neodym-Eisen-Bor-Magnet), 90° schwenkbar
- Schwenkbarer Haken am Boden

- IP54
- IK07



1838AM L I S L1 € 126,00 1 018380400
mm mm mm mm

1838COB

Tragbare LED-Lampe, aufladbar

- Aufhängbar, Körper aus rutschfestem und stoßfestem Gummi
- Lithium-Polymer-Batterie
- 100/200 Lumen; SPOT 75 Lumen

CE
IP65



1838COB € 109,00 1 018380010

1838P

Wiederaufladbare Inspektionslampe mit doppeltem Lichtaustritt: Lampe und Taschenlampe

- Kompakter Körper aus rutschfestem Gummi
- 50/80 Lumen
- Taschenaufhänger
- Magnetischer Boden kann um 180° gedreht werden
- Mit USB/microUSB 3,5mm Kabel
- Leuchtdauer: 2,5 Stunden
- IP20



1838P € 92,50 1 018380005

1838SLIM

Gelenk-3-LED-Lampe, schmal, aufladbar

- 3 Lichtstärken
- Frontlicht: 100/200 Lumen/ Rücklicht: 180 Lumen/ Kopflicht (Spot): 80 Lumen
- Magnetischer Boden
- Ladezeit: 2.5h
- Lichtdauer: 2-4h/ Spot 3h
- Inklusive USB-C-Kabel

CE
IP54

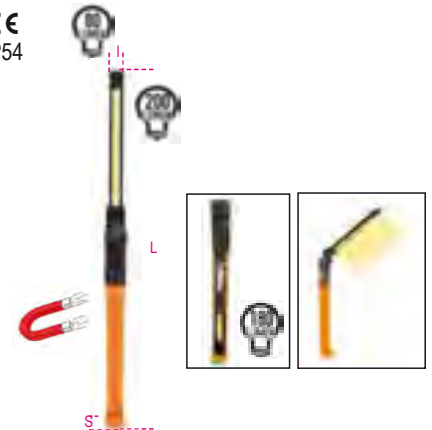

1838SLIM L I S € 84,50 1 018380221
mm mm mm



1838SW

Gelenk-LED-Lampe, aufladbar, mit kabellosem Aufladen

- Doppelte Lichtemission:
Frontlicht: LED COB, 3 Leuchtstärken: 250 - 500 - 1000 Lumen
Kopflicht (Spot): LED SMD, 200 Lumen
- Wiederaufladbare Batterie 3.6V 3.350mAh Li-Ion
- 2 Lademodi: kabellose Ladestation 1839BRW
Ladegerät mit USB-C-Anschluss
- Akkuladedauer: 6.5h mit kabelloser Ladestation
4.5h mit Ladegerät
- Akkulaufzeit: Frontlicht: 3-5h
Kopflicht (Spot): 7h
- Ladestandsanzeiger mit 3 LEDs
- Boden um 180° schwenkbar
- Körper aus rutschfestem Gummi
- Schwenkbarer Doppelhaken
- 3 Magnete an der Rückseite
- 1 Magnet am Boden
- IP65
- IK07
- Inkl. USB-C-Kabel



1838SW	L mm	I mm	S mm	€	1	018380142
	260	53	40	113,00		

1838UV

Aufladbare UV-Lampe + Weißlicht
Ideal für Lecksuche

- Kompaktes Gehäuse aus rutschfestem Gummi
- Mit Ladegerät 100-240Vac / 50-60Hz
- 150 Lumen / UV



1838UV	€	1	018380150
	183,00		

1838E

Aufladbare LED-Motorhaubenlampe

- 3 Lichtstärken: 500/1000/2000 Lumen
- 360° drehbar
- Längenbereich: 116 ± 188 cm
- Körper aus Aluminium
- Haken aus rutschfestem Gummi
- Aufladung über USB-C-Anschluss
- 2 Aufladungsvorgänge:
Aufladen mittels USB-Buchse an der Lampe
Aufladen mittels USB-Buchse der internen Batterie
- Inklusive Batterieladegerät
Input: 100-240V ~ 50/60Hz
Output: DC 5V - 2000 mA
- Leuchtdauer: 3-9 h
- IP20
- IK07

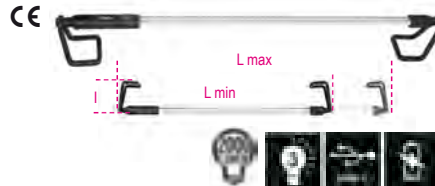

IP20
IK07

L min mm	L max mm	I mm	€	1	018380270
1170	1880	150	214,00		

1838E-BT

Wiederaufladbare Batterie mit USB-C-Anschluss für Motorhaubenlampe Art. 1838E

- Li-Ion 3,6V
- DC 5V - 2000 mA

CE

1838E-BT	€	1	018380271
	60,00		

1839BRW

Kabellose Aufladestation,
kompatibel mit Lampen 1838POCKET,
1838SW

- Zwei gleichzeitig verwendbare Aufladepositionen mit Magnetanschluss
- Mit abnehmbarer Halterung zur kabellosen Aufladung von Handys
- Akku-LED-Ladezustandsanzeiger
- Max. Eingang 10W x2
- Eingang: AC 100-240V 50/60Hz
- Ausgang: DC 12V 1.5A
DC 9V 2A
DC 5V 3A
- USB-C-Anschluss
- Kann an die Wand durch 3 an der Rückseite befindliche starke Magnete und 2 Schraubenlöcher gehängt werden
- IP20
- IK07



1839BRW	L mm	I mm	S mm	€	1	018390002
	101	190	28	107,00		

1839/R5

USB-C-Kabel, QC 3.0, Ersatzteil für Art.
1838POCKET und Art. 1839BRW

1839/R5	€	1	018390505
	9,80		

1839/R6

Quick-Charge-Transformator mit USB-Anschluss, Q C3.0, Ersatzteil für Art.
1838POCKET und Art. 1839BRW

1839/R6	€	1	018390506
	28,50		

1839/R1

Transformator mit USB-Ausgang, Ersatzteil für Art. 1833L/USB, 1836B, 1837F/USB, 1838COB, 1838P, 1838S, 1838SLIM, 1838UV, 1838AM, 1838E

CE

1839/R1	€	1	018390501
	28,00		

1839/R2

USB-Kabel/Klinkenstecker 3,5 mm, Ersatzteil für Art. 1836B; 1838P; 1838COB; 1838UV

1839/R2	€	1	018390502
	10,80		

1839/R4

USB/USB-C-Kabel, Ersatzteil für Art. 1833L/USB, 1833F/USB, 1838SLIM, 1838S, 1838AM, 1838E

1839/R4	€	1	018390504
	9,60		



1842LED/BM

LED-Arbeitslampe mit sehr hoher Leuchtkraft, 230 Vac

• Kabel 10 m

- Kompaktes Gehäuse aus rutschfestem Gummi
- Einfach zu wechselndes Frontglas
- Ausrichtbarer Haken
- 340 Lumen

• Mit Kopf-LED für multidirektionale Beleuchtung

CE



Item	L mm	€	Unit	Code
1842LED/BM	230	159,00	1	018420301

1842LED/ABM

LED-Arbeitslampe mit sehr hoher Leuchtkraft, 24 V

• Kabel 10 m

- Kompaktes Gehäuse aus rutschfestem Gummi
- Einfach zu wechselndes Frontglas
- Ausrichtbarer Haken
- 340 Lumen

• Mit Kopf-LED für multidirektionale Beleuchtung

CE



Item	L mm	€	Unit	Code
1842LED/ABM	230	150,00	1	018420311

ROLLEN



Die neue Auswahl der von Beta entworfenen und entwickelten Aufroller bietet ein breitgefächertes und vollständiges Programm, das die Ansprüche aller Professionisten erfüllt.

- Die Kabelaufroller sind in einer breiten Auswahl an Kabellängen und -typen, Ausführungen mit LED-Lampe sowie mit SCHUKO Steckdose und Stecker erhältlich.
- Die Schlauchaufroller werden in Durchmessern von 8 mm und 10 mm angeboten.

Hoch zugfeste Feder, die eine extrem lange Lebensdauer und die maximale flüssige Aufwicklung gewährleistet.

Gehäuse aus hochdichtem Polypropylen für eine hohe Stoßfestigkeit.

Zahnstangenvorrichtung, die die Blockierung der automatischen Kabelaufwicklung erlaubt.

Leichte Deaktivierung, die das Arbeiten im kontinuierlichen Zug ermöglicht.

Alle Aufroller sind mit einem um 180° schwenkbaren Bügel zur Wandbefestigung und mit einem zweiten Bügel zum schnellen Ein- und Aushaken aus der Wandhalterung ausgestattet.

KABELAUFROLLER

Die breite Produktpalette umfasst 18 Ausführungen, die den Arbeitsanforderungen der anspruchsvollsten Profis gerecht werden. In Längen von 10 m bis 30 m, mit Querschnitten von 2x1,0 mm² bis 5Gx1,5mm² und Kabeltypen H05VV-F und H07RN-F erhältlich. Alle Kabelaufroller mit Kabelquerschnitt bis 3Gx2,5mm² werden mit einem Thermoschutzschalter geliefert, der bei Stromkreisüberlastung ausgelöst wird.



347

SCHLAUCHAUFROLLER

Ein ausgewähltes Sortiment, mit Längen von 10 m bis 15 m und Durchmessern von 8 mm und 10 mm, zur Verwendung mit Druckluftwerkzeugen.

Da unsere Produkte leckagefrei sind, können sie auch mit Wasser verwendet werden.

Item	Code	Leiter	Querschnitt	Kabeltyp	Länge	Trommel	Thermoschutz	Zubehör
1842 15-H05/LED	018420821	2x	1,0 mm ²	H05VV-F	15+1 m	Small	JA	LED lamp
1843 15-H05	018430215	2x	1,5 mm ²	H05VV-F	15+1 m	Small	JA	
1844 10-H05	018440310	3G	1,5 mm ²	H05VV-F	10+1 m	Small	JA	-
1844 15-H05	018440315			H05VV-F	15+1 m	Small	JA	-
1844 15-H07	018440317			H07RN-F	14+1 m	Small	JA	-
1844 30-H05	018440330			H05VV-F	30+2 m	Medium	JA	-
1844 15-H05/SCK	018440316	3G	1,5 mm ²	H05VV-F	15+1 m	Small	JA	SCHUKO
1844 15-H07/SCK	018440318			H07RN-F	14+1 m	Small	JA	SCHUKO
1845 12-H05	018450365	3G	2,5 mm ²	H05VV-F	12+1 m	Small	JA	
1845 15-H07	018450367			H07RN-F	15+1 m	Medium	JA	
1845 25-H07	018450377			H07RN-F	25+1,5 m	Medium	JA	
1846 10-H05	018460405	4G	1,5 mm ²	H05VV-F	10+1 m	Small	NEIN	
1846 10-H07	018460407			H07RN-F	10+1 m	Small	NEIN	
1846 15-H05	018460415			H05VV-F	15+1 m	Small	NEIN	
1847 10-H05	018470420	4G	2,5 mm ²	H05VV-F	10+1 m	Medium	NEIN	
1847 15-H07	018470427			H07RN-F	15+1 m	Medium	NEIN	
1848 10-H05	018480510	5G	1,5 mm ²	H05VV-F	10+1 m	Medium	NEIN	
1848 15-H07	018480517			H07RN-F	15+1 m	Medium	NEIN	

Beta

1842

Automatik-Kabelaufroller mit LED-Arbeitslampe,
100-240Vac

- Mit Sicherheitstransformator: 230/12V
- Kabel: H05VV-F 2x1,0 mm²
- Kabellänge (aufgerollt): 15 m
- Eingangskabellänge: 1,5 m, mit SCHUKO-Stecker
- Anschlusskabellänge: 1 m
- Abnehmbarer Klick-Mechanismus (Kabel immer in Zugrichtung)
- Inkl. Bügel, 180° schwenkbar, und Schnellkupplungshalterung

CE

IP42
IP65



Art.	Kabel	L m	€	Stk	Art.
1842 15-H05/LED	H05VV-F	15+1	394,00	1	018420821

1846R-LED/BM

Ersatz LED-Lampen

12-24V - AC-DC



Art.	€	Stk	Art.
1846LED/BM R	109,00	1	018460331

1843

Automatik-Kabelaufroller, mit Kabel 2x1,5 mm²

- Kabel: H05VV-F 2x1,5 mm²
- Mit Thermoschutzschalter
- Kabellänge (aufgerollt): 15 m
- Anschlusskabellänge: 1 m
- Ohne Eingangskabel geliefert
- Abnehmbarer Klick-Mechanismus (Kabel immer in Zugrichtung)
- Maximale Belastbarkeit aufgerollt: 1300W (230V-20 °C)
- Maximale Belastbarkeit abgerollt: 2300W (230V-20 °C)
- Inkl. Bügel, 180° schwenkbar, und Schnellkupplungshalterung

CE

IP42



Art.	Kabel	L m	€	Stk	Art.
1843 15-H05	H05VV-F	15+1	263,00	1	018430215

1844

Automatik-Kabelaufroller, mit Kabel 3Gx1,5 mm²

- Kabel: 3Gx1,5 mm²
- Mit eingebautem Thermoschutzschalter
- Anschlusskabellänge: 1 m (außer Art. 1844 30-H05, 2 m)
- Ohne Eingangskabel geliefert
- Abnehmbarer Klick-Mechanismus (Kabel immer in Zugrichtung)
- Maximale Belastbarkeit aufgerollt: 1500W (230V-20 °C)
- Maximale Belastbarkeit abgerollt: 2500W (230V-20 °C)
- Inkl. Bügel, 180° schwenkbar, und Schnellkupplungshalterung

CE

IP42



Art.	Kabel	L m	€	Stk	Art.
1844 10-H05	H05VV-F	10+1	234,50	1	018440310
1844 15-H05	H05VV-F	15+1	257,00	1	018440315
1844 15-H07	H07RN-F	14+1	279,00	1	018440317
1844 30-H05	H05VV-F	30+2	494,00	1	018440330

1844SCK

Automatik-Kabelaufroller, Kabel 3Gx1,5 mm², mit SCHUKO-Stecker

- Kabel: 3Gx1,5 mm²
- Mit Thermoschutzschalter
- Anschlusskabellänge: 1 m
- Eingangskabellänge: 1,5 m, mit SCHUKO-Stecker
- Abnehmbarer Klick-Mechanismus (Kabel immer in Zugrichtung)
- Maximale Belastbarkeit aufgerollt: 1500W (230V-20 °C)
- Maximale Belastbarkeit abgerollt: 2500W (230V-20 °C)
- Inkl. Bügel, 180° schwenkbar, und Schnellkupplungshalterung

CE

IP42



Art.	Kabel	L m	€	Stk	Art.
1844 15-H05/SCK	H05VV-F	15+1	268,00	1	018440316
1844 15-H07/SCK	H07RN-F	14+1	290,00	1	018440318

1845

Automatik-Kabelaufroller, mit Kabel 3Gx2,5 mm²

- Kabel: 3Gx2,5 mm²
- Mit eingebautem Thermoschutzschalter
- Anschlusskabellänge: 1 m (außer Art. 1845 25-H07RN-F, 1,5 m)
- Ohne Eingangskabel geliefert
- Abnehmbarer Klick-Mechanismus (Kabel immer in Zugrichtung)
- Maximale Belastbarkeit aufgerollt: 2000W (230V-20 °C)
- Maximale Belastbarkeit abgerollt: 3000W (230V-20 °C)
- Inkl. Bügel, 180° schwenkbar, und Schnellkupplungshalterung

CE

IP42



Art.	Kabel	L m	€	Stk	Art.
1845 12-H05	H05VV-F	12+1	529,00	1	018450365
1845 15-H07	H07RN-F	15+1	529,00	1	018450367
1845 25-H07	H07RN-F	25+1,5	668,00	1	018450377

1846

Automatik-Kabelaufroller, mit Kabel 4Gx1,5 mm²

- Kabel: 4Gx1,5 mm²
- Ohne Thermoschutzschalter
- Anschlusskabellänge: 1 m
- Ohne Eingangskabel geliefert
- Abnehmbarer Klick-Mechanismus (Kabel immer in Zugrichtung)
- Maximale Belastbarkeit aufgerollt: 1400W (230V-20 °C)
- Maximale Belastbarkeit abgerollt: 1900W (230V-20 °C)
- Inkl. Bügel, 180° schwenkbar, und Schnellkupplungshalterung

CE

IP42



Art.	Kabel	L m	€	Stk	Art.
1846 10-H05	H05VV-F	10+1	285,00	1	018460405
1846 10-H07	H07RN-F	10+1	295,00	1	018460407
1846 15-H05	H05VV-F	15+1	295,00	1	018460415



1847

Automatik-Kabelaufroller, Kabel 4Gx2,5 mm²

- Kabel: 4Gx2,5 mm²
- Ohne Thermoschutzschalter
- Anschlusskabellänge: 1 m
- Ohne Eingangskabel geliefert
- Abnehmbarer Klick-Mechanismus (Kabel immer in Zugrichtung)
- Maximale Belastbarkeit aufgerollt: 2000W (230V-20 °C)
- Maximale Belastbarkeit abgerollt: 2700W (230V-20 °C)
- Inkl. Bügel, 180° schwenkbar, und Schnellkupplungshalterung

CE



IP42

		L m	€		
1847 10-H05	H05VV-F	10+1	306,00	1	018470420
1847 15-H07	H07RN-F	15+1	570,00	1	018470427

1848

Automatik-Kabelaufroller, Kabel 5Gx1,5 mm²

- Kabel: 5Gx1,5 mm²
- Ohne Thermoschutzschalter
- Anschlusskabellänge: 1 m
- Ohne Eingangskabel geliefert
- Abnehmbarer Klick-Mechanismus (Kabel immer in Zugrichtung)
- Maximale Belastbarkeit aufgerollt: 1400W (230V-20 °C)
- Maximale Belastbarkeit abgerollt: 1900W (230V-20 °C)
- Inkl. Bügel, 180° schwenkbar, und Schnellkupplungshalterung

CE



IP42

		L m	€		
1848 10-H05	H05VV-F	10+1	318,00	1	018480510
1848 15-H07	H07RN-F	15+1	608,00	1	018480517

1852R1750

Tragbares Induktionsheizgerät



CE

- Erwärmt und löst besonders blockierte Bolzen, Muttern, Naben und Lager ohne die Verwendung von Flammen
- Ermöglicht das Erhitzen jeder Art von ferromagnetischen Metallen

Lieferumfang:

- zwei Spulen mit Frontalanschluss, Durchmesser 19 und 26 mm, zum Lösen von Muttern
- eine Flachspule zum Erhitzen von Oberflächen
- eine 800 mm lange flexible Spule bzw. Schlauchspule
- geliefert in Kunststoffkoffer

Technische Daten:

- Eingangsspannung: 230V AC, 50/60 Hz
- Eingangsstrom: max. 7,5A
- Leistung: max. 1.75 kW

OPTIONAL

Zudem verfügbar sind andere Spulenmaße

VORTEILE

- Zeitsparung: Schnelles Erhitzen und hohe Präzision
- Brandschutz: Erzeugt keine Flammen, höchste Sicherheit für den Bediener
- Praktisch: Verwendbar mit nur einer Hand und leicht untereinander austauschbare Spulen

ANWENDUNGSBEREICHE

- Automotive
- Industriewartung
- Luftfahrtindustrie
- Schiffbauindustrie
- Petrochemische Industrie

	€		
1852R1750	1.765,00	1	018520175

480x370x130 mm - 4,5 kg

1852S-CNT

Kontaktpule



	€		
1852S-CNT	133,00	1	018520520

1852S-CC

Löffelspule



	€		
1852S-CC	107,00	1	018520521

1852S-KR/CNT

Kit Ersatzteile für Kontaktpule



	€		
1852S-KR/CNT	57,50	1	018520522

1852S-L

Spulen mit seitlichem Anschluss



	Ø mm	M	L mm	€		
1852S-L 19	19	M6	220	53,50	1	018520501
1852S-L 20	20	M8	220	53,50	1	018520502
1852S-L 23	23	M10	220	53,50	1	018520503
1852S-L 26	26	M12	220	53,50	1	018520504
1852S-L 32	32	M16	220	53,50	1	018520505
1852S-L 38	38	M20	220	61,50	1	018520506
1852S-L 45	45	M22	220	67,50	1	018520507

1852S-F

Spule mit Frontalanschluss



	Ø mm	M	L mm	€		
1852S-F 19	19	M6	220	53,50	1	018520508
1852S-F 20	20	M8	220	53,50	1	018520509
1852S-F 23	23	M10	220	53,50	1	018520510
1852S-F 26	26	M12	220	53,50	1	018520511
1852S-F 32	32	M16	220	53,50	1	018520512
1852S-F 38	38	M20	220	61,50	1	018520513
1852S-F 45	45	M22	220	65,50	1	018520514

1852S-FLESS

Flexible Spule



	L mm	€		
1852S-FL750	750	39,50	1	018520519
1852S-FLESS	800	101,00	1	018520515
1852S-FL1000	1000	130,00	1	018520517
1852S-FL1500	1500	153,00	1	018520518

1852 S-PIATTE

Flache Spule



	€		
1852S-PIATTE	61,50	1	018520516

Beta



SCHWEISSEN



INVERTERSCHWEISSGERÄTE

Bedienungsfreundliche Inverterschweißgeräte, hervorragende Schweißeigenschaften mit allen Elektrodentypen. Mit Überspannungs-, Übertemperatur- und Elektrodenverklebungskontrolle. Kompakt und leicht, ideal für Haus-, leichte Metallbau- und Wartungsarbeiten.



SCHWEISSERMASKEN

Beta bietet verschiedene LCD-Schweißmasken mit automatischer Verdunkelung für unterschiedliches Schweißen wie Elektroden-, MIG/MAG-, WIG- und Plasmaschweißen. Schutz und Komfort werden durch volle Einhaltung aller geltenden Sicherheitsvorschriften gewährleistet.



SCHWEISSZUBEHÖR

Große Auswahl an Zubehör zur Unterstützung von Schweißarbeiten.



ZINNSCHWEISSER UND GASSCHWEISSGERÄTE

Schweißgeräte und Zubehör für kleine Wartungsarbeiten und Arbeiten in der Mikroelektronik. Zusätzlich zu den kabelgebundenen Schweißgeräten bietet Beta verschiedene mit Butangas betriebene Lösungen an, die auch das Arbeiten im Freien und ohne Strom ermöglichen.

1808

LötKolben mit Zusatzheizleistung, mit verstärkter Spitze Art. 1824R8



W	V	€	Icon	Icon
20/130	230	97,50	1	018080001

1812 150

BlitzlötKolben



W	V	€	Icon	Icon
150	230	140,00	1	018120015

1814M

LötKolben mit verstärkter Spitze



W	V	€	Icon	Icon
25	230	78,50	1	018140225
30	230	82,50	1	018140230
40	230	89,50	1	018140240

1820

LötKolben



W	V	€	Icon	Icon
1820 30	30W	57,50	1	018200003
1820 60	60W	66,00	1	018200006
1820 80	80W	93,50	1	018200008

1822

Leistungsstarke LötKolben



W	V	€	Icon	Icon
1822 120	120W	143,00	1	018220012
1822 180	180W	151,00	1	018220018
1822 320	320W	188,00	1	018220032

1823 60

Lötstation mit Digitalanzeige komplett mit LötKolben

- Konstanttemperaturregelung von 160 °C bis 480 °C, mit einer Genauigkeit von ±1%.
- Speicherung der bei der Ausschaltung eingestellten Temperatur.
- 3 Schnellauswahltasten (200-300-400 °C).



W	€	Icon	Icon
60	552,00	1	018230060

1823R/60

ErsatzlötKolben für Art. 1823 60



W	€	Icon	Icon
1823R 60	110,00	1	018230066

1824R

Ersatzlötspitzen

W	V	€	Icon	Icon
1824R 08	1808	41,50	1	018240100
1824R 12	1812/150	5,70	1	018240301
1824R 14-M25	1814M/25	5,70	1	018240152
1824R 14-M30	1814M/30	5,70	1	018240153
1824R 14-M40	1814M/40	5,70	1	018240154
1824R 20	1820/30	7,50	1	018240302
1824R 60	1820/60	7,50	1	018240303
1824R 80	1820/80	10,80	1	018240304
1824R 120-180	1822/120 -/180	87,00	1	018240305
1824R 320	1822/320	111,00	1	018240307
1824R ST-60	1823-60	15,20	1	018240308

1825B

Löt-Schweißdraht mit Antioxidanzmittel

- 1 mm² Draht; 250 g
- Sn 99.3%; Cu 0.7%



W	€	Icon	Icon
1825B	81,50	1	018250251

1827

GaslötKolben, regulierbar



W	€	Icon	Icon
1827	175,00	1	018270001

1827PC

Ersatzspitzen kegelförmig, für Art. 1827

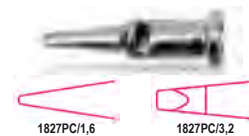

W	€	Icon	Icon
1827PC 1,6	36,50	1	018270501
1827PC 3,2	36,50	1	018270502

1827PCL

Ersatzspitzen mit Messer für Art. 1827



W	€	Icon	Icon
1827PCL 2,4	36,50	1	018270503



1827PFL

Ersatzspitzen mit offener Flamme für Art. 1827



1827PFL € 36,50 1 018270504

1827/K

GaslötKolben mit 7 Zubehörteilen im Koffer mit weicher Unterlage aus PUR-Schaumstoff



- Leistung: von 30 Watt bis 125 Watt
- Von 250 °C bis 500 °C einstellbare Temperatur der Lötspitze
- Gasflussregler
- Aufheizzeit: 15 Sekunden nach dem Einschalten
- Der Behälter enthält Gas für 120 Minuten Dauerbetrieb
- Durchsichtiger Behälter zur Überwachung des Gasfüllstands
- Mit Butangas wiederaufladbar

1827/K € 270,00 1 018270100

1827F

Butangas-LötKolben

35g Behälter

- drei auswechselbare Düsen 550 °C; 1000 °C und 1300 °C
- geliefert mit Ständer in Hartschalenkoffer



1827F € 192,00 1 018270200

1830T

Lötinnabsaugpumpe mit antistatischer Spitze aus Kunststoff



L mm 190 € 20,60 5 018300021

1860BH/120A

Inverterschweißgerät mit Gleichstromausgang (DC) zum MMA-Schweißen mit Rutil-, basischen und Edelstahl-Elektroden Kompakt und transportfreundlich

Arcforce-, Hotstart-, Anti-Sticking- und Thermostatfunktionen

Regelstrom: 10÷120A
Versorgungsspannung: 1x230V

Nutzungsfaktor (40 °C) :

25% - 160 A

60% - 100 A

100% - 80 A

Schutzart: IP22S

Verwendbare Elektroden: Ø 1.6 - 3.2mm Rutil, basisch, Edelstahl, Guss usw.

Geliefert mit 16mm² Kabeln

CE



1860BH/120A € 425,00 1 018600121

1860BH/160A

Inverterschweißgerät mit Gleichstromausgang (DC) zum MMA-Schweißen mit Rutil-, basischen und Edelstahl-Elektroden Kompakt und transportfreundlich

Arcforce-, Hotstart-, Anti-Sticking- und Thermostatfunktionen

Regelstrom: 10÷160A
Versorgungsspannung: 1x230V

Nutzungsfaktor (40 °C) :

25% - 160 A

60% - 100 A

100% - 80 A

Schutzart: IP22S

Verwendbare Elektroden: Ø 1.6 - 4mm Rutil, basisch, Edelstahl, Guss usw.

Geliefert mit 16mm² Kabeln

CE



1860BH/160A € 549,00 1 018600161

1860BH/200A

Inverterschweißgerät mit Gleichstromausgang (DC) zum MMA-Schweißen mit Rutil-, basischen und Edelstahl-Elektroden Kompakt und transportfreundlich

Arcforce-, Hotstart-, Anti-Sticking- und Thermostatfunktionen

Regelstrom: 10÷200A
Versorgungsspannung: 1x230V

Nutzungsfaktor (40 °C) :

25% - 200 A

60% - 130 A

100% - 100 A

Schutzart: IP22S

Verwendbare Elektroden: Ø 1.6 - 4mm Rutil, basisch, Edelstahl, Guss usw.

Geliefert mit 16mm² Kabeln

CE



1860BH/200A € 610,00 1 018600201

1860BH R/CM

Ersatzmassekabel für Inverter-Schweißgeräte Art. 1860BH-120/160/200A



1860BH R/CM € 58,50 1 018600612

1860BH R/CS

Ersatzelektrodenhalterkabel für Inverterschweißgeräte Art. 1860BH-120/160/200A



1860BH R/CS € 71,50 1 018600613

1860BHT/160A

Inverter-Schweißgerät mit Gleichstromausgang (DC) zum MMA- und TIG-Elektrodenschweißen auf Stahl. Kompakt und transportfreundlich

Arcforce-, STICK/TIG (Lift Arc)-, Hotstart-, Anti-Sticking- und Thermostatfunktionen

Regelstrom: 10÷160A
Versorgungsspannung: 1x230V

Nutzungsfaktor (40 °C):
60% - 160 A
100% - 130 A
Schutzart: IP23S
Verwendbare Elektroden: Ø 1,6 - 4 mm Rutil-, basisch, Edelstahl.
Mit 25-mm²-Kabeln

CE



1860BHT/160A € 1.068,00 1 018600179

1860BHT R/CM

Ersatzmassekabel für TIG-Schweißgeräte Art. 1860BHT



1860BHT R/CM € 91,00 1 018600616

1860BHT R/CS

Ersatzschweißzangenkabel für TIG-Schweißgeräte Art. 1860BHT



1860BHT R/CS € 118,00 1 018600617

1860BHT/T

WIG-Brenner für WIG-Schweißgeräte 1860BHT
Länge: 4 m
Verbinde: 50 mm²



1860BHT/T € 290,00 1 018600615

1860M

Magnetische Schweißwinkelklemmen, schnell einstellbar

Mit schwenkbarer Spannbacke
Ideal zum Spannen oder Fixieren von verschiedenen Werkstück-Größen



1860M L max mm 30 € 110,00 1 018600301

1860DM

Magnetscheiben zum Heben von Blech

Ideal zum Handling und Befestigen von Blech
Gleichmäßige Magnetkraft auf der ganzen Scheibenoberfläche
Griffe mit Loch, um senkrechte Bearbeitungen zu erleichtern



1860DM 16 kg max 16 € 62,50 1 018600310
1860DM 40 kg max 40 € 88,50 1 018600311

1860PMIG

Multifunktionszangen für MIG-Schweißen



1860PMIG L mm 215 L1 mm 44 € 45,50 2 018600350

1860EI

Magnetwinkel 90°, für Innen- und Außenecken.

Ideal zum Sichern/Blockieren von rohrförmigen oder platten Teilen

18 kg Magnetkraft mit Abschrägung für Ecken/Winkel von 30° und 60° mit Sechskantloch zum leichteren Entfernen des Magnets vom Metall



1860EI L mm 165 L1 mm 110 S mm 35 € 44,50 1 018600290

1860RG

Magnetwinkel, verstellbar 30°÷270°

Ideal zum Sichern/Blockieren von rohrförmigen oder platten Teilen

15 kg Magnetkraft
Sechskantschlüssel mitgeliefert zur Blockierung der Winkeleinstellung
Stift mitgeliefert zur Einstellung auf 30°-45°-90°/270°-180° mit Sechskantloch zum leichteren Entfernen des Magnets vom Metall



1860RG L mm 155 S mm 35 € 71,00 1 018600255

1860SQ

Magnetischer Winkel 45°/90°

Ideal zum Sichern/Blockieren von rohrförmigen oder platten Teilen

25kg Magnetkraft
Keine Batterie erforderlich, ON/OFF-Wirkung durch Neigung der internen Magnete
Entfernen der Späne mit Magneten auf Position OFF



1860SQ € 109,00 1 018600210





7041LCD/4S

LCD-Schweißermaske mit automatischer Verdunkelung, für Elektrodenschweißen; MIG/MAG; TIG und Plasmaschweißen.
4 Sensoren mit TRUE COLOR Filter
Spannungsversorgung mit Solarzellen und Lithium-Batterien für eine hervorragende Dauer des LCD-Filters

- Sichtfeld 98x80 mm
- variable Verdunklungsstufen 5÷8,5/ 9-13 mit interner Verstellung
- UV/IR Schutz: DIN16
- Verdunklungszeit 1/25000 s
- Aufhellzeit 0.1-2.0s
- Empfindlichkeit und Verzug der Verdunklung einstellbar
- Automatisches Ein- und Ausschalten
- Schleiffunktion
- Anzeige Batteriestand niedrig

- Ergonomisches Design, leicht und gut ausgewogen
- mit Stellmutter



7041LCD/4S € 351,00 1 070410001

7041LCD/4S-VE

Ersatz-Kratzschutzglas außen für Art. 7041LCD/4S

7041LCD/4S-VE € 8,60 2 070410101

7041LCD/4S-VI

Schutzglas innen für Art. 7041LCD/4S

7041LCD/4S-VI € 4,50 2 070410102

7042LCD

LCD-Schweißermaske mit automatischer Verdunklung, für Elektrodenschweißen; MIG/MAG; TIG und Plasmaschweißen.
Stromversorgung mit Solarzellen und Lithium-Batterien für eine hervorragende Dauer des LCD-Filters

- Sichtfeld 98x43 mm
- Verdunklungsstufe DIN 9-13 mit Außenverstellung
- UV/IR-Schutz
- Verdunklungszeit 1/25000 s
- Aufhellzeit 0.25-1s
- Empfindlichkeit und Verzug der Verdunklung einstellbar
- Automatisches Ein- und Ausschalten
- Schleifmodus
- Optimierte Form für ein problemloses Atmen bei abgesenktem Schutzschild



7042LCD € 246,00 1 070420001

7042LCD/RV

Kratzschutzglas für Art. 7042LCD, 7043

7042LCD/RV € 3,90 2 070420101

7042LCD/RV-INT

Internes Sichtglas für Art. 7042LCD, 7043

7042LCD/RV-INT € 3,50 2 070420102

7043

LCD-Schweißermaske mit automatischer Verdunklung, für Elektrodenschweißen; MIG/MAG, TIG und Plasmaschweißen.
Stromversorgung mit Solarzellen.

- Sichtfeld 92x43 mm
- Verdunklungsstufe DIN 9-13 mit Außenverstellung
- UV/IR-Schutz
- Verdunklungszeit 1/1000 s
- Aufhellzeit 0.1-1.0 s
- Empfindlichkeit und Verzug der Verdunklung einstellbar
- Automatisches Ein- und Ausschalten
- Schleifmodus
- Optimierte Form für ein problemloses Atmen bei abgesenktem Schutzschild



7043 € 143,00 1 070430001

KFZ-SPEZIAL

Unsere Kfz-Spezialwerkzeuge, die von den anspruchsvollsten Professionisten verwendet werden, wurden entwickelt und ausgelegt, um die höchsten Weltstandards zu erfüllen. Sie werden kontinuierlich unter schwersten Nutzungsbedingungen getestet. Seit mehr als 50 Jahren sind wir mit Stolz Seite an Seite mit den großen Meistern, die uns dabei helfen, unsere Produkte ständig zu verbessern, und die unsere absolut hohe Qualität bestätigen.

Die Kfz-Spezialwerkzeuge finden Sie in diesen Abschnitten:

Diagnostik	von 1438 bis 1499 von 1758VT bis 1760TMC
Motor	von 955 bis 989A von 1438 bis 1499
Öl und Filter	von 1438 bis 1499 von 1877 bis 1885
Electric system	von 1438 bis 1499
Anlasser	von 1498BC/12 bis 1498/40A
Getriebe	von 1438 bis 1499
Radaufhängungen	von 1549 bis 1569CP
Bremsen	von 1438 bis 1499
Bereifung	von 955 bis 989A
Karosserie	von 1302 bis 1369 von 1763 bis 1767A
Weitere Einrichtungen	von 1875LT bis 3067
Heben	von 3029/2T bis 3067/70-13T



1875LT

Teppich- und Polsterreiner mit Injektion/Extraktion-Funktion

Ideal zur gründlichen Reinigung von Stoffbezügen. Lässt das Reinigungsmittel unter Druck sprühen und saugt es zusammen mit dem Schmutz auf, sodass die Oberflächen fast trocken bleiben.

Im Lieferumfang enthaltenes Zubehör:

- 1 Schlauch mit ergonomischem Griff
- 1 Spendereinheit
- 2 feste Verlängerungen
- 1 kleine Sprüh-Saugdüse
- 1 große Sprüh-Saugdüse
- 6 Ringe zum Verriegeln des Stromversorgungskabels

CE



1875LT	€ 672,00	1	018750000
--------	----------	---	-----------

1875SP/K3

Bürstensatz zur Stoffreinigung

- 1 flache Bürste Ø 48 mm
- 1 flache Bürste Ø 100 mm
- 1 halbkugelige Bürste Ø 90 mm
- Schlagschrauberanschluss 1/4"

1/4



ISO 1173 E 6,3

1875SP/K3	€ 21,70	1	018750010
-----------	---------	---	-----------

1877

Altöl-Auffangbehälter, auf Rädern, mit 90 l Tank

- Füllstandanzeige
- Trichter mit großem Durchmesser und Gitter, Kapazität 12 l
- Pneumatische Tankentleerung durch 1,8-m Schlauch
- Werkzeugablagefläche

CE



1877	€ 839,00	1	018770008
------	----------	---	-----------

1877A

Altöl-Auffangbehälter/Absauggerät, auf Rädern, mit 90 l Tank und Vorkammer

- Füllstandanzeige
- Trichter mit großem Durchmesser und Gitter, Kapazität 12 l
- Transparente Vorkammer, Kapazität 9,5 l
- 1,8 m Saugrohr
- Pneumatische Tankentleerung durch 1,8-m Schlauch
- Werkzeugablagefläche

Standardzubehör:

- 1 Hartsonde, Ø 5x700 mm
- 1 flexible Sonde, Ø 5x700 mm
- 1 Hartsonde, Ø 6x600 mm
- 1 flexible Sonde, Ø 6x700 mm
- 1 flexible Sonde, Ø 7x700 mm
- 1 flexible Sonde, Ø 8x700 mm
- Adapter für VW, BMW, CITROËN

CE



1877A	€ 1.480,00	1	018770080
-------	------------	---	-----------

1877F

Altöl-Auffangbehälter für 1-l-Flaschen

- Kann bis zu 4 Flaschen gleichzeitig aufnehmen
- Inklusive 2 2-l-Tanke



H mm	L mm	P mm	€	1	018770100
405	270	240	115,00		

1877P

Altölsammelbehälter auf Rädern mit Polyethylen-Tank

- Tank Fassungsvermögen: 40 l
- Großer PPL-Ölauffangbehälter
- Füllstandanzeige
- Pneumatische Tankentleerung



H min-Max mm	H1 mm	l	€	1	018770180
1030-1630	900	40	510,00		

1878 2

Flüssigkeits-Auffangbehälter

- Maximales Fassungsvermögen: 2 l
- Besonders geeignet für den Ölwechsel an Scootern



l	H mm	€	1	018780002
2	85	17,10		

1878 3

Auffangbehälter für Öl Naben Truck
Ölablass mit Tropfenauffänger



l	€	1	018780003
3	26,00		

1878 4

Flüssigkeits-Auffangbehälter, transportierbar

- Geeignet für Motorräder
- Maximales Fassungsvermögen: 4 l
- Spritzschutz



l	H mm	€	1	018780004
4	100	36,50		

1878 8

Flüssigkeits-Auffangbehälter

- Höhe geeignet für Motorräder
- Maximales Fassungsvermögen: 8 l



1878 8	8	H mm 110	€ 19,30	1	018780008
--------	---	----------------	------------	---	-----------

1878 11

Auffangbehälter für Flüssigkeiten

- Max. Fassungsvermögen 11 l
- Flüssigkeitsablassschraube
- Interne Schottwand zum Vermeiden von Herausstritt der Flüssigkeit beim Transport



1878 11	11		€ 43,50	1	018780011
---------	----	--	------------	---	-----------

1878 30

Auffangbehälter für Flüssigkeiten

- Maximales Fassungsvermögen: 30 l
- Spritzschutzgitter
- Mit 4 drehbaren Laufrollen

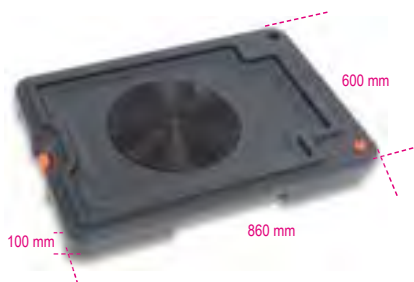

1878 30	30		€ 168,00	1	018780030
---------	----	--	-------------	---	-----------

1879

Manueller und pneumatischer Flüssigkeitssauger, 9,5 l



1879 9,5			€ 361,00	1	018790001
----------	--	--	-------------	---	-----------

1879 6

Manueller Nasssauger, 6 l



1879 6			€ 264,00	1	018790000
--------	--	--	-------------	---	-----------

1879R/K4

Satz 4 Ersatzrohre für Flüssigkeitsabsauger Art. 1879



1879R/K4			€ 69,50	1	018790504
----------	--	--	------------	---	-----------

1879/FUEL

Manueller Flüssigkeitssauger, 6 l

Verwendbar für Kohlenwasserstoffe



1879/FUEL	6		€ 157,00	1	018790010
-----------	---	--	-------------	---	-----------

1880

Manuelle Pumpe für Ölfässer

- Für Öl
- Nicht mit wässrigen Flüssigkeiten, Säurelösungen, Dieselöl, Benzin und Ähnlichem verwenden
- Inklusive Fassanschluss, Teleskoprohr und Ausguss
- Verwendbar mit 60-l, 100-l und 200-l Fässern



1880	gr 240		€ 68,00	1	018800001
------	-----------	--	------------	---	-----------

1880ADB

Rotationspumpe für AdBlue

- 5 Liter Ausgabe alle 20 Rotationen
- Verlängerungen bis zu 1,20 m für Fässer
- 1 Fassanschluss eng
- 1 Fassanschluss weit



1880ADB			€ 159,00	1	018800101
---------	--	--	-------------	---	-----------

1881

Druckluftpumpe für Ölfässer, Verhältnis 3:1

CE



1881	l/min 18		€ 580,00	1	018810001
------	-------------	--	-------------	---	-----------

1882N

Ölpistole mit flexiblem Auslauf und Tropfstopp

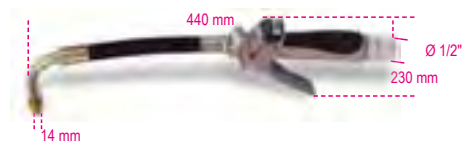

1882N			€ 175,00	1	018820110
-------	--	--	-------------	---	-----------

1883N

Digitaldurchlaufzähler für Öl



1883N			€ 247,00	1	018830036
-------	--	--	-------------	---	-----------

1883NC

Nippel mit Außengewinde 1/2 für Anschluss Art. 1882N und 1883N



1883NC € 15,50 1 018830135

1884

Werkzeug zum Nachfüllen von Öl in Schaltgetriebe, Automatikgetriebe und Differentiale

Komplett mit 12 Adaptern für direkten Anschluss



1884 € 573,00 1 018840010

AT-101	FORD
AT-102	UNIVERSAL (Bmw, Honda, Nissan...)
AT-103	VW-AUDI
AT-104	VW-AUDI-PORSCHE
AT-105	VW-AUDI-MINI COOPER
AT-106	MERCEDES
AT-107	DSG
AT-108	VW-AUDI CVT
AT-109	VOLVO
AT-110	TOYOTA-LEXUS
AT-111	SKODA
AT-112	VW Passat/Tiguan <2007

1884/C12

Adapterkoffer für Art. 1884



1884/C12 € 213,00 1 018840100

1884N/C8

Adaptersatz, 8-teilig, für Art. 1884

Satzinhalt:

- 1 Adapter für Fahrzeuge Infiniti, 7-Gang, M8x1.0
- 1 Adapter für Fahrzeuge Honda, Hyundai, Kia 5x8x200 mm
- 1 Adapter für Fahrzeuge Skoda M18x1.5
- 1 Adapter für Fahrzeuge Mini M14x1.5
- 1 Adapter für Fahrzeuge Nissan M10x1.5
- 1 Adapter für Fahrzeuge Nissan Juke M12x1.25
- 1 Adapter für Fahrzeuge GM M12x1.75
- 1 Adapter für 7-Gang-Fahrzeuge der VAG-Gruppe



1884N/C8 € 140,00 1 018840200

200x145x40 mm - 400 g

1889N

Fassuntersatz aus Stahl zur Beförderung und Lagerung von 2 Fässern à 200 l



1889N € 953,00 1 018890220

1889CF

Universalschlüssel zum Öffnen von Fässern

- 1 Sechskanteinsatz Ø 38 mm
- 1 Profil mit 4 Querschnitten Ø 42 mm
- 1 Klinge 17x7 mm

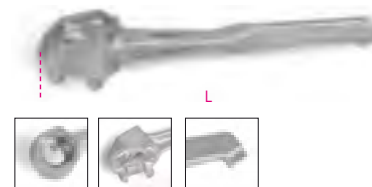

L mm 270 € 40,00 1 018890010

1885

Servicegerät für Automatikgetriebe

Ermöglicht eine total sichere Durchführung des gesamten Spüzyklus und des Ölaustauschs in allen Automatikgetrieben mit einem einfachen und geführten Arbeitsvorgang. Verhindert Schäden durch Verschleiß des im Automatikgetriebe enthaltenen Öls und somit auch das Auftreten von typischen Fehlfunktionen wie: Hoher Geräuschpegel des Getriebes, blockierte Gänge, abruptes Einlegen der Gänge, verlängerte Schaltzeiten.



FUNKTIONEN

Automatikbetrieb

Schritt für Schritt Prozedur mit integrierter Datenbank Abgleich zwischen Füllstand und Rücklaufmenge (Frischöl / Altlösmenge), sodass ständig die korrekte Ölmenge in der Anlage ist

Durchflussmesser für Sichtprüfung der Ölqualität Report Ausdruck für jeden durchgeführten Vorgang

AUTOMATISCHE FUNKTIONEN

Zuführung Lösemittel (fakultativ)

Getriebeespülung

Entleeren des Öls der Wanne

Entleeren des Öls des Wandlers

Zuführung des Öls des Wandlers

TECHNISCHE EIGENSCHAFTEN

Spannungsversorgung: 220 V 50 Hz

Hintergrundbeleuchtete Ölsichtfenster mit 2 LEDs Weißes Licht

Elektronische Waagen Nr. 2

Elektronische Waagen Auflösung +/- 10 g

Platine mit hintergrundbeleuchtetem Grafikdisplay

1885 € 10.130,00 1 018850010



1885/C1

Kit Anschlüsse Automatikgetriebe für Art. 1885

Der Kit beinhaltet:

- 1885/C1-R1 Anschlüsse Getriebe Land Rover Freelander
- 1885/C1-R2 Anschluss Getriebe DP0
- 1885/C1-R3 Anschluss Getriebe ZF 9HP
- 1885/C1-R4 Füllstandstab Getriebe ZF 9HP
- 1885/C1-R5 Füllstandstab Getriebe Mercedes
- 1885/C1-R6 Anschlüsse Getriebe AISIN TG82
- 1885/C1-R7 Anschlüsse Getriebe AISIN TG81
- 1885/C1-R8 Anschlüsse Getriebe Renault-Nissan



1885/C1 € 874,00 1 018850110

1885/C1-R1

Anschlüsse Getriebe Land Rover Freelander für Art. 1885

lc01430



1885/C1-R1 € 75,50 1 018850111

1885/C1-R2

Anschluss Getriebe DP0 für Art. 1885

lc0990



1885/C1-R2 € 132,00 1 018850112

1885/C1-R3

Anschluss Getriebe ZF 9HP für Art. 1885

lc0992



1885/C1-R3 € 147,00 1 018850113

1885/C1-R4

Füllstandstab Getriebe ZF 9HP für Art. 1885

lc0192



1885/C1-R4 € 81,50 1 018850114

1885/C1-R5

Füllstandstab Getriebe Mercedes für Art. 1885

K-A-M



1885/C1-R5 € 136,00 1 018850115

1885/C1-R6

Anschlüsse Getriebe AISIN TG82 für Art. 1885

lc01820



1885/C1-R6 € 146,00 1 018850116

1885/C1-R7

Anschlüsse Getriebe AISIN TG81 für Art. 1885

lc0150



1885/C1-R7 € 146,00 1 018850117

1885/C1-R8

Anschlüsse Getriebe Renault-Nissan für Art. 1885

lc02150



1885/C1-R8 € 146,00 1 018850118

1885/C2

Kit Anschlüsse Automatikgetriebe für Art. 1885

Der Kit beinhaltet:

- 1885/C2-R1 Anschlüsse Getriebe Audi 8HP
- 1885/C2-R2 Anschlüsse Getriebe ZF 9HP ohne Austauscher
- 1885/C2-R3 Anschlüsse Getriebe Audi 0KC
- 1885/C2-R4 Anschlüsse Getriebe AG4-ZF 4HP
- 1885/C2-R5 Anschlüsse Getriebe FIAT
- 1885/C2-R6 Anschlüsse Getriebe Audi Q5-Q7
- 1885/C2-R7 Anschluss Getriebe Audi 0B5



1885/C2 € 709,00 1 018850120

1885/C2-R1

Anschlüsse Getriebe Audi 8HP für Art. 1885

lc0993



1885/C2-R1 € 143,00 1 018850121

1885/C2-R2

Anschlüsse Getriebe ZF 9HP ohne Austauscher für Art. 1885

lc0860



1885/C2-R2 € 92,50 1 018850122

1885/C2-R3

Anschluss Getriebe Audi 0KC für Art. 1885

lc02020



1885/C2-R3 € 146,00 1 018850123

1885/C2-R4

Anschlüsse Getriebe AG4-ZF 4HP für Art. 1885

lc0750



1885/C2-R4 € 126,00 1 018850124

1885/C2-R5

Anschlüsse Getriebe FIAT für Art. 1885

lc0061



1885/C2-R5 € 55,00 1 018850125

1885/C2-R6

Anschlüsse Getriebe Audi Q5-Q7 für Art. 1885

lc0680



1885/C2-R6 € 136,00 1 018850126

1885/C2-R7

Anschlüsse Getriebe Audi 0B5 für Art. 1885

Ic01720



1885/C2-R7 € 81,50 1 018850127

1885/C3

Kit Anschlüsse Automatikgetriebe für Art. 1885

Der Kit beinhaltet:

- 1885/C3-R1 Anschluss Getriebe DSG Mercedes
- 1885/C3-R2 Anschluss Getriebe POWERSHIFT
- 1885/C3-R3 Anschlüsse Getriebe Toyota IQ
- 1885/C3-R4 Anschlüsse Getriebe Mazda
- 1885/C3-R5 Anschlüsse Getriebe Renault Laguna-Esp
- 1885/C3-R6 Anschlüsse Getriebe Nissan Juke
- 1885/C3-R7 Anschlüsse Getriebe AISIN TF71 FV
- 1885/C3-R8 Anschlüsse Getriebe AISIN TF71 FP
- 1885/C3-R9 Anschlüsse Getriebe AISIN TF71 FO
- 1885/C3-R10 Anschlüsse Getriebe AISIN TF71 FS



1885/C3 € 1.255,00 1 018850130

1885/C3-R1

Anschluss Getriebe DSG Mercedes für Art. 1885

Ic0191



1885/C3-R1 € 146,00 1 018850131

1885/C3-R2

Anschluss Getriebe POWERSHIFT für Art. 1885

Ic0190



1885/C3-R2 € 146,00 1 018850132

1885/C3-R3

Anschlüsse Getriebe Toyota IQ für Art. 1885

Ic0991



1885/C3-R3 € 146,00 1 018850133

1885/C3-R4

Anschlüsse Getriebe Mazda für Art. 1885

Ic02130



1885/C3-R4 € 146,00 1 018850134

1885/C3-R5

Anschlüsse Getriebe Renault Laguna-Esp für Art. 1885

Ic02150



1885/C3-R5 € 146,00 1 018850135

1885/C3-R6

Anschlüsse Getriebe Nissan Juke für Art. 1885

Ic02140



1885/C3-R6 € 146,00 1 018850136

1885/C3-R7

Anschlüsse Getriebe AISIN TF71 FV für Art. 1885

Ic01420



1885/C3-R7 € 146,00 1 018850137

1885/C3-R8

Anschlüsse Getriebe AISIN TF71 FP für Art. 1885

Ic001420/1



1885/C3-R8 € 146,00 1 018850138

1885/C3-R9

Anschlüsse Getriebe AISIN TF71 FO für Art. 1885

Ic001420/2



1885/C3-R9 € 146,00 1 018850139

1885/C3-R10

Anschlüsse Getriebe AISIN TF71 FS für Art. 1885

Ic001420/3



1885/C3-R10 € 146,00 1 018850140

1885/XC60

Anschlüsse Getriebe Volvo XC60 für Art. 1885



1885/XC60 € 156,00 1 018850151

1893/134A

Automatisches Klimatestservicegerät für Kältemittel R134a

Komplett automatisches Modell, mit Datenbank für PKW/LKW mit Kältemittelmenge, Kompressor Ölmenge und Öltyp, Eigendiagnose-Software für ordentliche Wartungsarbeiten. Die Datenbank kann via Software aktualisiert werden. Das Gerät kann sowohl manuell (mit Kontrolle des Bedieners für jede Arbeitsphase) als auch komplett automatisch betrieben werden (ohne Kontrolle des Bedieners).



R134a (250 ml)

FUNKTIONEN

Automatikbetrieb
Datenbank für PKW/LKW mit Kältemittelmenge, Datenbank für PKW/LKW mit Kältemittelmenge, Kompressor Ölmenge und Öltyp
Automatisches Absaugen des Kältemittels aus der Leitung
Ausgleich der Ladung der in den Leitungen enthaltenen Kältemittelladung
Automatischer Ablass der nicht kondensierbaren Gase
Automatische Meldung von Störungen und Wartung
Manometer Ø 80 mm
Digitaler Vakuummeter

TECHNISCHE EIGENSCHAFTEN

Kältemitteltank: 15 kg
Vakuumpumpe: 75 l/min
Elektronische Waage: 50kg
Platine mit hintergrundbeleuchtetem Display
Rückgewinnungsgeschwindigkeit: 500 g/min
Spannungsversorgung: 220 V

1893/134A € 7.370,00 1 018930001

1893/1234YF

Automatisches Klimaservicegerät für Kältemittel R1234yf

Komplett automatisches Modell, mit Datenbank für PKW/LKW mit Kältemittelmenge, Kompressor Ölmenge und Öltyp, Eigendiagnose-Software für ordentliche Wartungsarbeiten. Die Datenbank kann via Software aktualisiert werden. Das Gerät kann sowohl manuell (mit Kontrolle des Bedieners für jede Arbeitsphase) als auch komplett automatisch betrieben werden (ohne Kontrolle des Bedieners).



CE



1234YF (250 ml)

FUNKTIONEN

Automatikbetrieb
Datenbank für PKW/LKW mit Kältemittelmenge, Datenbank für PKW/LKW mit Kältemittelmenge, Kompressor Ölmenge und Öltyp
Automatisches Absaugen des Kältemittels aus der Leitung
Ausgleich der Ladung der in den Leitungen enthaltenen Kältemittelladung
Automatischer Ablass der nicht kondensierbaren Gase
Automatische Meldung von Störungen und Wartung
Manometer Ø 80 mm
Digitaler Vakuummeter

TECHNISCHE EIGENSCHAFTEN

Kältemittelkanal: 15 kg
Vakuumpumpe: 75 l/min
Elektronische Waage: 50 kg
Platine mit hintergrundbeleuchtetem Display
Rückgewinnungsgeschwindigkeit: 500 g/min
Spannungsversorgung: 220 V

1893/1234YF € 7.600,00 1 018930012

1893TR/134A

Lecksuchmittel für Gas R134a



1893TR/134A ml 250 € 51,50 1 018930901

1893TR/1234YF

Lecksuchmittel für Gas R1234yf



1893TR/1234YF ml 250 € 59,00 1 018930902

1893TR/CI

Lecksuchmittel für Hybridkompressoren



1893TR/CI ml 250 € 61,50 1 018930903

1895G

Stromerzeuger zur Steuerung für Elektroinjektoren (Benzin und LPG) und Magnetventile

Ermöglicht die Effizienz von folgenden Bauteilen in voller Autonomie zu prüfen:

- AGR-Magnetventile
- Elektroinjektoren von Benzin- und LPG-Motoren
- Magnetventile zur Regelung von Turbine mit variabler Geometrie
- Kompressoren für Klimaanlage der neuen Generation



CE

VORTEILE

- Ermöglicht die Prüfung, ob das Bauteil mechanisch funktioniert
 - In Kombination mit Ultraschallwannen wird die Reinigungswirkung der Bauteile erhöht, da das Bauteil während der Reinigungsphase elektronisch angesteuert wird
 - Unerlässlich zur Kontrolle der Effizienz des Kompressors und seines Regelventils
- ### TECHNISCHE EIGENSCHAFTEN
- Steuerung Benzin- und LPG Injektoren:
- Anzahl von Ausgängen: 4
 - Testdauer: 1-60 s
 - Öffnungszeit: 5-10 ms
 - Impulsfrequenzeinstellung: 1-10 Hz
- Steuerung PWM-Geräte:
- Anzahl Ausgänge: 1
 - Testdauer: 1-60 min
 - Automatisch oder manuell
 - Tastverhältniseinstellung: 10%-85%
 - Signalfrequenzeinstellung: 120-250 Hz
- Einschließlich 4 Steckverbindern mit Faston Steckverbindern
Spannungsversorgung: 110-220 V
Abmessungen: 334x240x74 mm
Gewicht: 4 kg

1895G € 2.200,00 1 018950800

1895/S

Verstellbarer Halter für Ultraschallreinigungswanne 1895

Ermöglicht die korrekte Positionierung der Injektoren während der Reinigungsphase in der Ultraschallreinigungswanne

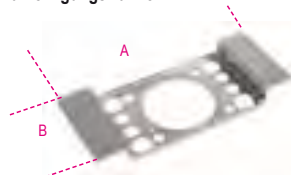

1895/S A mm 340 B mm 140 € 130,50 1 018950501

1895 6

Ultraschall-Reinigungswanne, 6 l

Mit spezieller Entgasungsfunktion



CE

- Durch das Aufheizen der Flüssigkeit und dank der Wirkung des Ultraschalls wird eine wirksame Reinigung der Ersatzteile und Metallteile allgemein (Injektoren, Vergaser, Ventile usw.) ermöglicht

- Digitaldisplay mit Einstellung der Temperatur und der Reinigungszeit
- Doppelte Waschkfunktion: "soft" und "normal"
- Für eine allgemeine Reinigung reicht die Verwendung von Wasser mit einer Temperatur von 50/60 °C
- Für eine sorgfältigere Reinigung Reinigungsmittel speziell für Ultraschall-Reinigungswannen geeignete nicht schaumbildende Reinigungsmittel hinzufügen
- Die Entgasungsfunktion beschleunigt die Freisetzung von Luft im ganzen Volumen der Wanne und erhöht so die Wirksamkeit des Ultraschalls

TECHNISCHE DATEN

Fassungsvermögen: 6 l
Ablassventil
Leistung: 150 Watt
Heizleistung: 300 Watt
Temperatureinstellung: 0+80 °C
Waschzeiteinstellung: 0-99 Minuten
Frequenz: 40 kHz
Spannungsversorgung: 220/230V
Abmessungen: 330x180x310 mm
Abmessungen Behälter: 300x155x150 mm
Abmessungen Reinigungskorb: 250x105x100 mm
Max. Tragfähigkeit: 5,5 kg

1895 6 Max 5,5 € 849,00 1 018950060

1895 13

Ultraschall-Reinigungswanne, 13 l

Mit spezieller Entgasungsfunktion



CE

- Durch das Aufheizen der Flüssigkeit und dank der Wirkung des Ultraschalls wird eine wirksame Reinigung der Ersatzteile und Metallteile allgemein (Injektoren, Vergaser, Ventile usw.) ermöglicht

- Digitaldisplay mit Einstellung der Temperatur und der Reinigungszeit
- Doppelte Waschkfunktion: "soft" und "normal"
- Für eine allgemeine Reinigung reicht die Verwendung von Wasser mit einer Temperatur von 50/60 °C
- Für eine sorgfältigere Reinigung Reinigungsmittel speziell für Ultraschall-Reinigungswannen geeignete nicht schaumbildende Reinigungsmittel hinzufügen
- Die Entgasungsfunktion beschleunigt die Freisetzung von Luft im ganzen Volumen der Wanne und erhöht so die Wirksamkeit des Ultraschalls

TECHNISCHE DATEN

Fassungsvermögen: 13 l
Ablassventil
Leistung: 300 Watt
Heizleistung: 400 Watt
Temperatureinstellung: 0+80 °C
Waschzeiteinstellung: 0-99 Minuten
Frequenz: 40 kHz
Spannungsversorgung: 220/230V
Abmessungen: 350x325x320 mm
Abmessungen Behälter: 325x235x145 mm
Abmessungen Reinigungskorb: 257x185x100 mm
Max. Tragfähigkeit: 12 kg

1895 13 Max 12 € 1.315,00 1 018950130

1895 27

Ultraschallreinigungswanne,
27 l

Mit spezieller Entgasungsfunktion



CE

- Durch das Aufheizen der Flüssigkeit und dank der Wirkung des Ultraschalls wird eine wirksame Reinigung der Ersatzteile und Metallteile allgemein (Injektoren, Vergaser, Ventile usw.)

- Digitaldisplay mit Einstellung der Temperatur und der Reinigungszeit

- Doppelte Waschfunktion: "soft" und "normal"

- Für eine allgemeine Reinigung reicht die Verwendung von Wasser mit einer Temperatur von 50/60 °C-

Für eine sorgfältigere Reinigung speziell für Ultraschallwannen geeignete nicht schaumbildende Reinigungsmittel hinzufügen (z. B. Arexons Fulcron Extra)

- Die Entgasungsfunktion beschleunigt die Freisetzung von Luft im ganzen Volumen der Wanne und erhöht so die Wirksamkeit des Ultraschalls

TECHNISCHE DATEN

Fassungsvermögen: 27 l

Ablassventil Leistung: 500 Watt

Heizleistung: 500 Watt

Temperatureinstellung: 0+80 °C

Washzeiteinstellung: 0-99 Minuten

Frequenz: 40 kHz

Spannungsversorgung: 220/230V

Abmessungen: 530x330x380 mm

1895 27	Max 25	€ 1.835,00	1	018950270
---------	-----------	---------------	---	-----------

1895/RC

Reinigungskorb für Ultraschall-
Reinigungswannen Art. 1895



	L mm	L1 mm	A mm	€	1	018950270
1895/RC6	250	105	100	53,50	1	018950506
1895/RC13	257	185	100	85,00	1	018950513
1895/RC27	450	250	150	143,50	1	018950527

9881U



9881U 1 (1-2)	567
9881U 1 (3)	567

9882R



9882R 1 (1-2)	567
9882R 1 (3)	567

1897

Professionelle Werkbank-Sandstrahlkabine

Insbesondere geeignet für die Oberflächenendbearbeitung von verschiedenen Materialien (Metall, Kunststoff, Glas, Keramik, Holz usw.). Die Kabine ist aus Stahlblech gefertigt mit Verstärkungen zur Gewährleistung höchster Robustheit und Stabilität.

Die Kabine verfügt über:

- Ladetür mit Magnetverschluss
- Lochblechplatte
- Standardanschluss für Sauger ø 36 mm
- Sichtfenster mit Polycarbonatschutzfilm 6 mm
- Beleuchtung mit LED-Lampe
- Druckluftkreis (Drucklufteintritt)
- Sandstrahlpistole mit Abzug



CE

TECHNISCHE DATEN

Nutzabmessungen Kabine: 600x520x320 mm

Außenabmessungen: 660x530x500 mm

Gewicht: 38 kg

Arbeitsplatte: Lochblech

Beleuchtung: LED

Luftverbrauch: 340 l/min 7 atm

Spannungsversorgung: 220 V - 50 Hz

1897	€ 4.080,00	1	018970066
------	---------------	---	-----------

1897/CRB

Korund für Sandstrahlkabine 1897 in 25 kg
Sack



1897CRB	€ 204,50	1	018970101
---------	-------------	---	-----------

1897/G

Granatsand (Granet) für Sandstrahlkabine
1897 in 25 kg Sack



1897G	€ 164,50	1	018970104
-------	-------------	---	-----------

1897/MV

Glasmikrokugeln für Sandstrahlkabine 1897 in
25 kg Sack



1897MV	€ 270,00	1	018970103
--------	-------------	---	-----------

1898/K40

Manuelle Reinigungswanne mit Warmwasser-
Umwälzsystem und Bakterien

- Ermöglicht die Beseitigung der Entsorgungskosten für Lösemittel oder Kohlenwasserstoffe
- Durch Nutzung des ökologischen Reinigungsmittels Beta auf der Basis von Enzymen und Bakterien können die an mechanischen Teilen vorhandenen ölhaltigen Rückstände entfernt und entsorgt werden
- Durch die Enzyme wird der ölhaltige Stoff vom Feststoff getrennt, während die Bakterien die Ölrückstände in Kohlenstoffdioxid und Wasser umwandeln und so das Reinigungsmittel kontinuierlich regenerieren

CE



AUSGESTATTET MIT

- Langborsten-Bürste und Verbindungsleitung
- Vorbereitung für Rechts- und Linkshandgebrauch
- Lochrost aus Edelstahl
- Laufrollen mit Bremse
- Karte mit Display zur Anzeige von Betriebstemperatur und Warnhinweis Füllstand niedrig

UMFASST:

- 2 Kanister umweltverträgliche Reinigungsflüssigkeit, 20 Liter und 2 Packungen Bakterien

TECHNISCHE DATEN

- Max. Pumpendurchsatz: 10 Liter/Minute

- Fassungsvermögen Behälter: 40 Liter

- Betriebstemperatur: +5 °C + +40 °C

- Abmessungen: 900 x 1000 x 750 mm

- Gewicht: 50 kg leer

1898/K40	€ 5.430,00	1	018980004
----------	---------------	---	-----------

ACHTUNG

Länder, in denen das Produkt 1898/K40 vertrieben werden kann: Belgien, Frankreich (ab 2021), Italien, Niederlande, Österreich, Polen, Portugal, Spanien, Ungarn, Vereinigtes Königreich.

1898/B

Bakterienflasche, 300 ml,
für Teilereinigungswanne Art. 1898/K40



1898/B	€ 112,00	1	018980904
--------	-------------	---	-----------

ACHTUNG:

Länder, in denen das Produkt 1898/B vertrieben werden kann: Österreich, Belgien, Frankreich, Italien, Niederlande, Polen, Portugal, Vereinigtes Königreich, Spanien, Ungarn

1898/D

Behälter umweltkompatible
Reinigungsflüssigkeit,
20 l, für Teilereinigungswanne Art. 1898/K4



1898/D € 223,00 1 018980920

ACHTUNG:

Länder, in denen das Produkt 1898/B vertrieben werden kann: Österreich, Belgien, Frankreich, Italien, Niederlande, Polen, Portugal, Vereinigtes Königreich, Spanien, Ungarn

1898/M

Druckzerstäuber
mit 1,5-l-Tank

- Verstellbare Düse für Linear- oder Sprühstrahl
- Messskala: 0,5 l - 1 l - 1,5 l
- Verriegelungshebel für kontinuierlichen Strahl
- Nicht verwendbar mit Kohlenwasserstoffen



H mm l € 18,00 1 018980930

1898/S

Handdruckpumpe
mit 5-l-Tank

- Flachdüse aus Edelstahl
- Verriegelungshebel für kontinuierlichen Strahl
- Verstellbare Düse für Linear- oder Sprühstrahl
- Bequemer Trageriemen für den Transport
- Handgriff mit Kupplung für die Flachdüse
- 1,2-m-Schlauch
- Nicht verwendbar mit Kohlenwasserstoffen



H mm l € 31,50 1 018980932



1899A

Reinigungsmaschine für DPF- und FAP®-Systeme

Unter Verwendung geeigneter Reinigungsmittel können durch Ruß- und Ascheablagerungen verschmutzte DPF/ FAP®-Systeme periodisch gereinigt und regeneriert werden.



Ausstattung:

- 1 Druckleitung Länge 2 m
 - 1 Schnellanschluss + Schlauchtülle für Differentialfühlerleitungen
 - 1 Niple M18x1,5 mit Schlauchtülle zum direkten Anschluss an Lambdasonden
 - 1 Verlängerungsleitung
 - 1 Spritzdüse für DPF/FAP®-Filter
 - 1 magnetische Leitungshalterung
 - 1 Leitung für DPF/FAP®-Filter mit Einstellungskabelverschraubung + Niple M14/16/18 mm zum Anschluss an Lambdasonden
- Technische Eigenschaften:
- Betriebsspannung: 12 V
 - Versorgungskabellänge: 3,9 m
 - Behälterfassungsvermögen: 1 l

1899A € 1.480,00 1 018990010

1899SI

2-in-1-Gerät für die Reinigung der Injektoren und des Ansaugkrümmers bzw. Saugrohrs
Mittels der Verwendung von entsprechenden Reinigungsmitteln können die Injektoren und Ansaugkrümmer/Saugrohre in Benzin- und Dieselmotoren einer regelmäßigen Reinigung unterzogen werden, bei der die Kohlenstoffablagerungen und Verbrennungsrückstände (Verkokungen) beseitigt werden



Technische Eigenschaften:

- Betriebsspannung: 12 V
- 2 Versorgungsrohre mit Schnellanschlüssen
- 2 Behälter (Fassungsvermögen: je 1 l)

1899SI € 5.540,00 1 018990030

2080/VG

Kleinteile-Organizer aus ABS mit Drehplatten

- Ausgestattet mit einem oberen Behälter für Kleinteile (Durchmesser 145 mm) und 4 Drehplatten:
- 1 Durchmesser 305 mm
- 3 Durchmesser 445 mm
- Geliefert komplett mit 12 innerhalb der 3 größeren Drehplatten anbringbaren Trennelementen, um bis zu 8 Fächer pro Ebene zu erreichen



2080/VG € 200,00 1 020800100

445x445x550 mm - 3,4 kg

2250-0

Drehhocker mit Aufbewahrungsschale



2250-0 € 129,00 1 022500011

2252

Rollsitz



2252-G € 217,00 1 022520002

2252KR4

Ersatzräder für Sitz 2252



2252KR4 € 72,50 1 022520900

2258N-0

Werkstattsitz mit Schubladen



2258N-0	€ 223,00	1	022580021
---------	----------	---	-----------

2258RR

Ersatzrad für Werkstattsitz 2258N



2258RR	€ 13,00	1	022580111
--------	---------	---	-----------

2254A

Autoabdeckungen für den Außenbereich, wasserabweisend und UV-beständig

Diese Abdeckungen bieten einen hervorragenden Schutz für auf Reparatur wartende Unfallwagen

Technische Eigenschaften

- Außenfinish mit UV-Schutz-Behandlung
- Weiches, kratzfestes Innenfinish
- 6 verstellbare Bänder für eine optimale Passform
- 2 Reißverschlüsse an den Vordertüren zum leichten Zugang zum Fahrzeuginnenraum, ohne die Abdeckung entfernen zu müssen
- Seitenspiegel-Taschen
- Reflektierend



3 Ausführungen:

- Größe M - geeignet für Kleinwagen
- Größe L - geeignet für Limousinen und Kombis
- Größe XL - geeignet für SUV

	LxPxH mm	€		
/M	4400x1450x1300	181,00	1	022540002
/L	5300x1450x1150	203,00	1	022540000
/X	4700x1450x1580	186,00	1	022540001

2254C

Saugnapfschutz für Fahrzeugkarosserien

Aus plastifiziertem Stoff mit 4 Saugnäpfen auf Oberseite



2254C	L1 mm	L2 mm	€		
	1150	650	59,00	1	022540200

2254F

Frontschutz Auto

Ermöglicht, den Frontbereich des Fahrzeugs zu schützen, und die Öffnungen für die Scheinwerfer und den Kühler zu lassen



- Wasserdicht
- Öl- und fettbeständig
- Befestigung mittels Schnürriemen
- Material: 98% Polyamid/Nylon, 2% Polyurethan

2254F	€		
	102,00	1	022540150

2254K

Schutz für Sitz, Lenkrad und Knauf des Schalthebels, wiederverwendbar

Geeignet für den Großteil von Sitzen, Lenkrädern und Schalthebelknäufen von Fahrzeugen



2254K	€		
	34,50	1	022540101

2254SM

Montagematte aus EVA

Doppelbeschichtung:

- 1 Seite aus weichem EVA
- 1 Seite aus hartem Carbon look für ein leichtes Rutschen



2254SM	€		
	80,00	1	022540033

2254T

Knieschutz-Matte

Aus rutschfestem EVA-Schaum



2254T	€		
	35,00	1	022540047

3000L

Montageroller

- PVC-Überzug mit Schaumgummipolsterung für hohen Komfort.



3000L	€		
	205,00	1	030000210

3000L/RLS

Ersatzräder für Montageroller



3000L/RLS	€		
	14,90	6	030000212

3002

Montageroller und Sitz

- Stahlstruktur
- PVC-Überzug mit Schaumgummipolsterung
- Möglichkeit zur schnellen Positionsregulierung: Montageroller oder Sitz

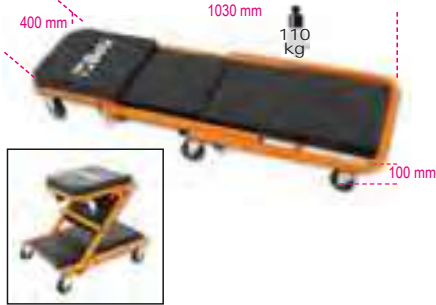

3002 € 136,00 1 030020001

3002/RLS

6 Ersatzrollen für Montageroller Art. 3002



3002/RLS € 35,00 1 030020501

3003

Montageroller aus stoßfestem Kunststoff

- Ø Räder: 76 mm



3003 € 106,00 1 030030001

3003/RLS

6 Ersatzrollen für Montageroller Art. 3003



3003/RLS € 55,50 1 030030501



3003C

Montageroller aus stoßfestem Kunststoff

- Ausgestattet mit:
- Kissen für den Kopf- und Lendenbereich mit Carbon Look Verkleidung
 - Obere Plättchen aus Metall für die Befestigung von Magnet-Zubehör
 - 6 Laufrollen aus Gummi mit Durchmesser 79 mm
 - Max. Tragfähigkeit: 120 kg
 - Gewicht 5,5 kg



3003C € 286,00 1 030030100

3003C/RLS

6 Ersatzräder für Montageroller Art. 3003C



3003C/RLS € 115,00 1 030030600

3003PRO

Montageroller aus stoßfestem Kunststoff

- Ausgestattet mit:
- ergonomisches Kopfstützenkissen
 - weicher Schutz für Rücken
 - 2 Laufrollen, 178 mm, mit Doppelkugellager, die die Verwendung auch auf unebenem Untergrund sowie das Überrollen von Rohren/Kabeln ermöglichen
 - 1 Lenkrolle
 - Zweifache Höhenverstellung vom Boden: 38 mm oder 76 mm
 - 2 tragbare LED-Lampen, 250 Lumen, mit Befestigungsmagneten
 - Tragfähigkeit: 200 kg
 - Gewicht: 7,7 kg



C max	H min	H Max	H1	€	1	030030150
kg	mm	mm	mm	401,00	1	030030150
200	170	230	230			

3003PRO/SP

Wandhalterung aus Kunststoff für Montagematte Art. 3003PRO

Kann an einer Wand, einer Hebebühne, einem Werkzeugwagen oder sonstigem angebracht werden, Befestigung der Matte durch ein Schnellschlusssystem mit Sicherheitsverschluss.



3003PRO/SP € 108,00 1 030030151

3003PRO/PM

Runde Kleinteileschale, magnetisch, für Montageroller Art. 3003PRO

Durch Anbringen an der Radfelge des Montagerollers können die Kleinteile während der Eingriffe aufbewahrt werden



3003PRO/PM € 11,70 1 030030152

3003PRO/RCR

Paar Ersatz-Hinterräder für Montageroller Art. 3003PRO



3003PRO/RCR € 85,00 1 030030650



3003PRO/RRG

Drehbares Ersatz-Vorderrad für Montageroller Art. 3003PRO



3003PRO/RRG € 26,50 1 030030651

3003PRO/RT

LED-Lampe mit Ersatzmagneten für Montageroller Art. 3003PRO

- 250 Lumen
- Batterien: 4xAAA (nicht inklusive)



3003PRO/RT € 19,30 1 030030652

3004

Radstopper



	H mm	L mm	L1 mm	€		
3004	225	475	200	43,50	1	030040000

KFZ-SPEZIAL

Unsere Kfz-Spezialwerkzeuge, die von den anspruchsvollsten Professionisten verwendet werden, wurden entwickelt und ausgelegt, um die höchsten Weltstandards zu erfüllen. Sie werden kontinuierlich unter schwersten Nutzungsbedingungen getestet. Seit mehr als 50 Jahren sind wir mit Stolz Seite an Seite mit den großen Meistern, die uns dabei helfen, unsere Produkte ständig zu verbessern, und die unsere absolut hohe Qualität bestätigen.

Die Kfz-Spezialwerkzeuge finden Sie in diesen Abschnitten:

Diagnostik	von 1438 bis 1499 von 1758VT bis 1760TMC
Motor	von 955 bis 989A von 1438 bis 1499
Öl und Filter	von 1438 bis 1499 von 1877 bis 1885
Electric system	von 1438 bis 1499
Anlasser	von 1498BC/12 bis 1498/40A
Getriebe	von 1438 bis 1499
Radaufhängungen	von 1549 bis 1569CP
Bremsen	von 1438 bis 1499
Bereifung	von 955 bis 989A
Karosserie	von 1302 bis 1369 von 1763 bis 1767A
Weitere Einrichtungen	von 1875LT bis 3067
Heben	von 3029/2T bis 3067/70-13T



3006

Hebvorrichtung und Positionierer für Räder von Traktoren und Baggern

- Max. Tragfähigkeit 1200 kg
- Minimaler Raddurchmesser 1000 mm
- Maximaler Raddurchmesser 2200 mm
- Maximale Reifendicke 800 mm



3006 € 2.145,00 1 030060000

3006 R/RGF

Drehbares Ersatzrad mit Bremse für Hebvorrichtung und Radpositionierer Art. 3006



3006 R/RGF € 82,00 1 030060501

3006 R/RG

Drehbares Ersatzrad für Hebvorrichtung und Radpositionierer Art. 3006



3006 R/RG € 71,50 1 030060502

3007

Unterboden-Rollwagen für Fahrzeuge ohne Fahrschemel/Hinterachse

- Ermöglicht die Positionierung von Fahrzeugen ohne Fahrschemel oder Hinterachse
- 4 drehbare Räder, davon 2 gebremst, zur Verwendung im Lackierofen
 - 2 verschiebbare Stützen für alle Fahrwerke
 - Max. Gewicht: 800 kg

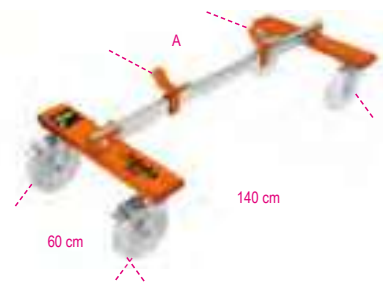

3007 € 772,00 1 030070001

3007 R/RGF

Drehbares Ersatzrad mit Bremse für Unterboden-Rollwagen für Fahrzeuge Art. 3007



3007 R/RGF	€ 128,00	1	030070501
------------	----------	---	-----------

3007 R/RG

Drehbares Ersatzrad für Unterboden-Rollwagen für Fahrzeuge Art. 3007



3007 R/RG	€ 112,00	1	030070502
-----------	----------	---	-----------

3008N

Hebevorrichtung und Positionierer für Einzel- und Doppel-LKW-Räder

- Max. Tragfähigkeit: 500 kg
- Min. Höhe: 120 mm
- Max. Höhe: 650 mm
- Distanz zwischen Rollen: 429÷670 mm
- Überlastungssicherungsventil
- Drehbare Fronträder

CE

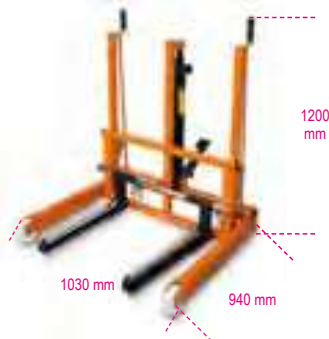

3008N	€ 3.640,00	1	030080110
-------	------------	---	-----------

3009

Rangierhilfe / Fahrzeugroller

Max. Tragfähigkeit 550 kg
4 Schwingwalzen
Walzenbreite 200 mm
Geeignet für Reifen bis 240 mm Breite



A	B	€	1	030090001
400÷850 mm	600 mm	505,00		

3009R/GR4

4-Rädergruppen Rangierhilfe/Fahrzeugroller Art. 3009 R/GR4



3009R/GR4	€ 207,00	1	030090501
-----------	----------	---	-----------

3010/T...

Böcke, 1 Paar

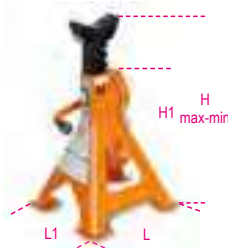

C max	H min	H max	H1	L	L1
kg	mm	mm	mm	mm	mm
2000	280	425	245	185	165

3010T 2	€ 120,00	1	030100002
---------	----------	---	-----------

C max	H min	H max	H1	L	L1
kg	mm	mm	mm	mm	mm
3000	285	430	250	180	195

3010T 3	€ 142,00	1	030100003
---------	----------	---	-----------

C max	H min	H max	H1	L	L1
kg	mm	mm	mm	mm	mm
6000	400	580	340	245	280

3010T 6	€ 206,00	1	030100006
---------	----------	---	-----------

C max	H min	H max	H1	L	L1
kg	mm	mm	mm	mm	mm
10000	471	735	420	330	290

3010T 10	€ 354,00	1	030100010
----------	----------	---	-----------

3011/T

Hydraulische Heber

CE



C max	H min	H Max	L
kg	mm	mm	mm
2000	174	369	90

3011T 2	€ 107,00	1	030110020
---------	----------	---	-----------

C max	H min	H Max	L
kg	mm	mm	mm
3500	170	366	86

3011T 3,5	€ 120,00	1	030110035
-----------	----------	---	-----------

C max	H min	H Max	L
kg	mm	mm	mm
5000	203	467	118

3011T 5	€ 134,00	1	030110050
---------	----------	---	-----------

C max	H min	H Max	L
kg	mm	mm	mm
10000	220	484	114

3011T 10	€ 200,00	1	030110100
----------	----------	---	-----------

C max	H min	H Max	L
kg	mm	mm	mm
15000	230	497	113

3011T 15	€ 245,00	1	030110150
----------	----------	---	-----------

C max	H min	H Max	L
kg	mm	mm	mm
20.000	245	521	115

3011T 20	€ 351,00	1	030110200
----------	----------	---	-----------

3010H

Stützböcke, schwere Ausführung



C Max	H min	H Max	L	L1
kg	mm	mm	mm	mm
15.000	445	631	300	300

3010H631-T15	€ 389,00	1	030100150
--------------	----------	---	-----------

C Max	H min	H Max	L	L1
kg	mm	mm	mm	mm
15.000	645	1077	300	300

3010H1077-T15	€ 480,00	1	030100165
---------------	----------	---	-----------

3010V

Stützböcke, schwere Ausführung, mit Schraubverstellung



C Max	H min	H Max	L	L1
kg	mm	mm	mm	mm
20.000	410	600	330	330

3010V600-T20	€ 557,00	1	030100200
--------------	----------	---	-----------

C Max	H min	H max	L	L1
kg	mm	mm	mm	mm
20.000	665	1090	460	460

3010V1090-T20	€ 707,00	1	030100220
---------------	----------	---	-----------

3012 Motorhalterungen



L mm	C max kg	€	📄	📦
1500	500	364,00	1	030120010
1800	400	493,00	1	030120018

3012C Motorabsenkhaltung

Ideal für PKWs und Nutzfahrzeuge



3012C	€	📄	📦
	960,00	1	030120255

3012I Motorhaltebügel, unten



3012I	L mm	H mm	€	📄	📦
	630-960	190	853,00	1	030120250

3014 Motorhalteblock



3014	€	📄	📦
	458,00	1	030140010

3014R/GR5 5 Ersatzrollen für Motorhaltebock Art. 3014



3014R/GR5	€	📄	📦
	115,00	1	030140501

3014 SAR Klappbarer Motorhaltebock

- Leicht einklappbar mit erheblicher Platzeinsparung
 - Ermöglicht die 360° Drehung des Motors oder des Getriebes
 - Garantiert maximale Sicherheit und Stabilität während den Eingriffen
- Max. Tragfähigkeit: 450 kg



3014 SAR	€	📄	📦
	1.675,00	1	030140360

3014 SAR/RR 4 Ersatzrollen für Motorhaltebock Art. 3014 SAR



3014 SAR/RR	€	📄	📦
	182,00	1	030140370

3014 SAR/1 Auffang- und Sammelbehälter von Flüssigkeiten für Art. 3014 SAR

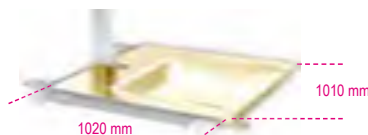

3014 SAR/1	€	📄	📦
1020x1010x11 mm	492,00	1	030140361

3014 SAR/2 Bügel für die Befestigung des Getriebes auf dem Halteblock Art. 3014 SAR



3014 SAR/2	€	📄	📦
	474,00	1	030140362

3023 Halter für Getriebeheber mit Schraubeneinstellung

Max. Tragfähigkeit: 400 kg



3023	H min-Max mm	Ø mm	€	📄	📦
	1350-2030	300	253,00	1	030230050

3025N Klappbarer hydraulischer Kran mit doppelwirkender Pumpe

- Merkmale:**
- Max. Tragfähigkeit: 1 t
 - 4-fach verstellbarer Lastarm: 300-600-800-1000 kg
 - Mit UL-Sicherheitsventil und verchromtem Kolben
 - Überwachung der Absenkgeschwindigkeit
 - Nylon-Räder
 - Max. Höhe: 2420 mm



A mm	B mm	C mm	D mm	€	📄	📦
1560	1600	1000	880	2.590,00	1	030250110

3025N/PF

Fasszange

Maximale Tragfähigkeit: 300 kg

CE



	A mm	B mm	€	1	030250111
3025N/PF	550+640	70	566,00		

3026 0,3

Hydraulischer Getriebeheber

CE



H min mm	H Max mm	L mm	L1 mm	Ø mm	€	1	030260003
1120	1970	450	450	25	824,00		

3026/R0,3

4 Ersatzlenkrollen für hydraulischen Getriebeheber Art. 3026 0,3



3026/R 0,3	208,00	1	030260903
------------	--------	---	-----------

3026 0,5

Hydraulischer Getriebeheber

Max. Tragfähigkeit: 500 kg

CE



H min mm	H Max mm	L mm	L1 mm	Ø mm	€	1	030260005
1140	1990	600	550	30	980,00		

3026/R0,5

4 Ersatzlenkrollen für hydraulischen Getriebeheber Art. 3026 0,5



3026/R 0,5	289,00	1	030260905
------------	--------	---	-----------

3026 1,0

Hydraulischer Getriebeheber

Max. Tragfähigkeit: 1 t

CE



H min mm	H Max mm	L mm	L1 mm	Ø mm	€	1	030260010
1140	1990	650	550	35	1.184,00		

3026/R 1,0

4 lenkbare Ersatzräder für hydraulischen Getriebeheber Art. 3026 1,0



3026/R 1,0	373,00	1	030260910
------------	--------	---	-----------

3026/S

Schwenkbarer Halter für Getriebe mit Reduzierbuchsen für Heber Art. 3026

Maximale Tragfähigkeit: 500 kg

CE



3026/S	697,00	1	030260501
--------	--------	---	-----------

3026/SP

Universal-Getriebeabstützung

Ermöglicht einem Bediener schnellen und sicheren Ab- und Anbau des Getriebes von PKWs und Nutzfahrzeugen sowie Offroad-Fahrzeugen.

CE



3026/SP	811,00	1	030260505
---------	--------	---	-----------

3026/SA

Radnabenhalter für Getriebeheber

- Verwendbar für Wartungseingriffe bzgl. Radnaben und während der Arbeiten zum Austausch von Stoßdämpfern
- anpassbar für hydraulische Getriebeheber Art. 3026 0,3 und Art. 3026 0,5



Ø mm	€	1	030260510
30,4	170,00		

3026/SAM

Stoßdämpferhalter für Getriebeheber

- Verwendbar zum Abstützen des Stoßdämpfers beim Ausbau des Stoßdämpferarms
- Bügel für Stoßdämpfer mit max. Durchmesser 80 mm, und Reduzierung für max. Durchmesser 60 mm
- anpassbar für hydraulische Getriebeheber Art. 3026 0,3 und Art. 3026 0,5



3026/SAM	219,00	1	030260515
----------	--------	---	-----------

3027N 10

Hydraulische Werkbankpresse mit beweglichem Kolben

- Max. Tragfähigkeit: 10 t
- 2-Stufen-Handpumpe
- Beweglicher Kolben
- Automatischer Rücklauf des Kolbens
- Inklusive V-Prismensatz
- Verchromter Ständer

CE



3027N 10 € 2.285,00 1 030270101

3027N 20

Hydraulische Presse mit beweglichem Kolben

- Max. Tragfähigkeit: 20 t
- 2-Stufen-Handpumpe
- Beweglicher Kolben
- Verchromter Ständer
- Automatischer Rücklauf des Kolbens
- Überlastungssicherungsventil
- Manometer
- Inklusive V-Prismensatz

CE



3027N 20 € 3.160,00 1 030270102

3027N 30

Hydraulische Presse mit beweglichem Kolben und Seilwinde

- Max. Tragfähigkeit: 30 t
- 2-Stufen-Handpumpe
- Beweglicher Kolben
- Verchromter Ständer
- Automatischer Rücklauf des Kolbens
- Überlastungssicherungsventil
- Manometer
- Stahlseilwinde zum Anheben der Arbeitsplatte

CE



3027N 30 € 5.530,00 1 030270103

3027N 50

Hydraulische Presse mit beweglichem Kolben und Seilwinde

- Max. Tragfähigkeit: 50 t
- 2-Stufen-Handpumpe
- Beweglicher Kolben
- Verchromter Ständer
- Automatischer Rücklauf des Kolbens
- Überlastungssicherungsventil
- Manometer
- Inklusive V-Prismensatz
- Stahlseilwinde zum Anheben der Arbeitsplatte

CE



3027N 50 € 7.710,00 1 030270105

3027N 100

Elektrohydraulische Presse, motorisiert, mit beweglichem Kolben und Seilwinde

- Max. Tragfähigkeit: 100 t
- Dreiphasenmotor: 230-400 V
- Frequenz: 50 Hz
- Elektromotorleistung: 3 kW
- Elektrohydraulische Pumpe mit 2 Geschwindigkeiten
- Steuerung mit 3-Stufen-Hebelverteiler: vorwärts-neutral-rückwärts
- Beweglicher Kolben
- Kolben-Ø: 100 mm
- Anheben der Arbeitsplatte mit Stahlseilwinde
- Netzkabel mit 4-poliger 380V-Industrie-Steckdose
- Motoröl inbegriffen

CE



3027N 100 € 23.770,00 1 030270110

3027N/KP

Splinttreibersatz und Platte für Art. 3027N



		€		
3027NKP10-20	3027N10-20	424,00	1	030270511
3027NKP30	3027N 30	592,00	1	030270531
3027NKP50	3027N 50	724,00	1	030270541
3027NKP100	3027N 100	1.330,00	1	030270552

3027N/KPP

Fußsteuerung für hydraulische Pressen 3027N



		€		
3027N/KPP10		453,00	1	030270560
3027N/KPP50		514,00	1	030270565



3027/PR

Untergestell Presse für Abziehen/Einsetzen von Naben, Lagern und Silentblock

Universalsystem, das mittels einer Stützbasis und dem entsprechenden Zubehör unter der Presse arbeitet und den Aus-/Einbau von Naben, Lagern und Silentblock aus/in ihre/n Aufnahmen ermöglicht.
Das Werkzeug passt sich den unregelmäßigen geometrischen Formen der Naben/Zapfen an, an denen der Techniker eingreifen muss.



TECHNISCHE DATEN

Arbeitsbereich: Min. 130 mm - Max. 186 mm
Abmessungen: 300 x 300 mm
Gewicht: 13 kg
Maximale Tragfähigkeit: 20 t

3027/PR € 746,00 1 030270400

3028 15

Hydraulische Presse mit beweglichem Kolben für Werkbank

Max. Tragfähigkeit: 15 t
Höhenverstellbare Auflageebene
Beweglicher Kolben



A mm 1010 B mm 565 C mm 480 D mm 80+370 € 1.240,00 1 030280015

3028SP/15

Schutzschirm für Presse Art. 3028 15



3028SP/15 € 181,00 1 030280016

3028 20

Hydraulische Presse mit beweglichem Kolben

Max. Tragfähigkeit: 20 t
Höhenverstellbare Auflageebene
Beweglicher Kolben

CE

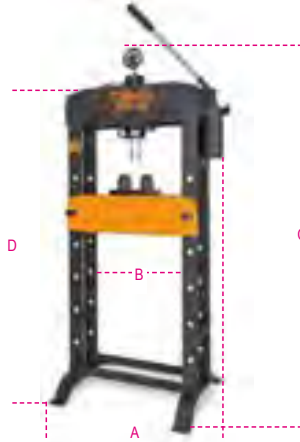

A mm 850 B mm 540 C mm 1830 D mm 1602 € 1.805,00 1 030280020

3028SP/20

Schutzschirm für Pressen Art. 3028 20



3028SP/20 € 202,00 1 030280021

3028 30

Hydraulische Presse mit beweglichem Kolben

Max. Tragfähigkeit: 30 t
Höhenverstellbare Auflageebene
Beweglicher Kolben

CE

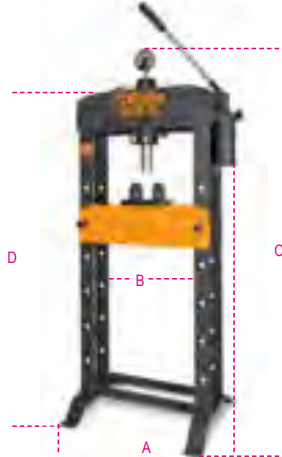

A mm 850 B mm 540 C mm 1850 D mm 1650 € 2.520,00 1 030280030

3028SP/30

Schutzschirm für Pressen Art. 3028 30



3028SP/30 € 202,00 1 030280031

3028 50

Hydraulische Presse mit beweglichem Kolben und Seilwinde

Max. Tragfähigkeit: 50 t
Mittels Seilwinde höhenverstellbare Auflageebene
Beweglicher Kolben

CE



A mm 1100 B mm 750 C mm 1850 E mm 820 € 4.400,00 1 030280050

3028SP/50

Schutzschirm für Pressen Art. 3028 50



3028SP/50 € 214,00 1 030280051

3028/KP

Spintreibtreesatz und Platte für Art. 3028



3028/KP € 157,00 1 030280055



3029/2T

Abgeflachter hydraulischer Heber 2 Tonnen mit 4 Rädern

- Schnellvorschubpedal
- Stahlstruktur und Nylon-Räder
- Mindesthöhe 75 mm

CE



3029/2T € 502,00 1 030290020

3029L/2T

Abgeflachter hydraulischer Heber 2 Tonnen, lange Ausführung

- Ermöglicht das Arbeiten an Fahrzeugen mit niedriger Höhe vom Boden und internem Hebepunkt
- Gesteuerte Absenkgeschwindigkeit
 - Schnellvorschubpedal
 - Nylon-Räder

CE



3029L/2T € 581,00 1 030290120

3029/2T-L/RP

85 mm Ersatzplatte für Art. 3029/2T und Art. 3029L/2T



3029/2T-L/RP € 19,70 1 030290502

3029/2T-L/R6

Ersatz-Hinterrad für Art. 3029/2T, Art. 3029L/2T, 3030H/2T, Art. 3033E/3T



3029/2T-L/R6 € 63,50 1 030290506

3029/2T-L/R5

Ersatz-Vorderrad für Heber Art. 3029/2T und Art. 3029L/2T



3029/2T-L/R5 € 59,00 1 030290505

3030/2T

Abgeflachter hydraulischer Heber 2T mit 6 Rädern

- Doppelklappräder aus Kunststoffmaterial (PTFE) vorne
- optimale Handhabung des Hebers auf unebenem und unregelmäßigem Boden
- Maximale Tragkraft: 2 Tonnen

CE



3030/2T € 954,00 1 030300020
43 kg

3030/2T-R5

Vorderrad mit Bolzen für Heber Art. 3030 2T



3030 2T/R5 € 33,50 1 030300505

3030/2T-R6

Ersatzhinterrad für Art. 3030/2T



3030 2T/R6 € 52,00 1 030300506

3030/2TRP

85 mm Ersatzplatte aus Gummi für Art. 3030/2T



3030/2TRP € 6,90 5 030300501

3030H/2T

Hydraulischer Hi-Lift Heber, 2 Tonnen, mit 6 Rädern

- Ermöglicht das Arbeiten an Fahrzeugen in großer Höhe vom Boden aus und mit einem langen Stoßdämpferweg
- Gesteuerte Absenkgeschwindigkeit
 - Schnellvorschubpedal
 - Nylon-Räder

CE



H min-Max mm	L mm	L1 mm	€	1	030300220
85+780	1010	300	799,00	1	030300220

3033/3T

Hydraulischer Heber 3t lange Ausführung

- Für die Verwendung an Kleintransportern geeignet
- Maximale Tragkraft: 3 t
- Polyamid-Räder

CE



€	1	030330030
1.265,00	1	030330030



3033E/3T

Hydraulischer Heber,
3 Tonnen

- Gesteuerte Absenkgeschwindigkeit
- Nylon-Räder

CE



	H	L	L1	€	Icon	Icon
	min-Max	mm	mm			
3033E/3T	95-515	700	370	468,00	1	030330130

3033S 3T/R2

Ersatz-Vorderrad
für Heber Art. 3033E/3T



3033S 3T/R2	€ 53,50	1	030330532
-------------	---------	---	-----------

Beta

3035

Reifenwagen

- Zum mühelosen Transport von Reifen mit Durchmesser bis zu 980 mm
- Der robuste Rahmen ermöglicht das Handling der Reifen, ohne deren Gewicht zu tragen
- Verwendbar als Ablagefläche, aufgrund der waagrecht arretierten Position
- 2 Räder Ø 260 mm
- 2 Räder Ø 125 mm
- Max. tragbare Höhe 1,60 m
- Max. Tragfähigkeit 200 kg
- In 2 Positionen arretierbare Gabeln: erste Position max. Öffnung 880 mm zweite Position max. Öffnung 980 mm



3035	€ 1.151,00	1	030350100
------	------------	---	-----------

3036

Grundgestell für Radrangierhilfe

Nicht markierende Gummiräder



3036	€ 136,00	1	030360063
------	----------	---	-----------

3061/2T

Lufthydraulischer Wagenheber, 2 Tonnen - 2 Stufen

CE



Ausgestattet mit:

- 3-schichtige hochbelastbare Membran und interne Teleskopführung
- Endlagenstopp und Überbelastungs-Sicherheitsventil
- Auch geeignet für Anwendung auf Autoliften

TECHNISCHE DATEN

Max. Gewicht: 2 t
 Gewicht: 14 kg
 Versorgungsdruck: 8-10 bar
 Höhe: min. 132 - max. 326 mm

3061/2T	€ 1.070,00	1	030610020
---------	------------	---	-----------

3061/2T-P50

50-mm Verlängerung für Artikel 3061/2T



3061/2T P50	€ 91,00	1	030610021
-------------	---------	---	-----------

3061/2T-P100

100-mm Verlängerung für Artikel 3061/2T



3061/2T P100	€ 122,00	1	030610022
--------------	----------	---	-----------

Beta

3065/20-10T

Lufthydraulischer Wagenheber, 20-10 t mit Transportkoffer

Tragbar und leichtgewichtig, ideal für Hilfseinsätze auf der Straße



- Mit zwei Verlängerungen (75 und 60 mm) geliefert

TECHNISCHE DATEN

Tragfähigkeit: 20-10 t
Gewicht: 23 kg
Versorgungsdruck: 8-10 bar
Luftverbrauch: 400 l/min

3065/20-10T € 3.160,00 1 030650100

3065/40-20T

Lufthydraulischer Wagenheber, 40/20 Tonnen



- Geeignet für Verwendung an schweren Fahrzeugen
- Einfache Handhabung, auch für mobile Reparaturarbeit
- automatische Kolbenrückführung
- 2 Absenkenventile mit Geschwindigkeitskontrolle unter Belastung

TECHNISCHE DATEN

Max. Gewicht: 40/20 t
Gewicht: 39 kg
Versorgungsdruck: 8-10 bar
Luftverbrauch: 400 l/min

3065/40-20T € 3.550,00 1 030650200

3067/60-15T

Lufthydraulischer Wagenheber, 60-30-15 t

Mit einer Mindesthöhe von nur 120 mm ist der Heber besonders für den Einsatz an Omnibussen, Reisebussen und öffentlichen Verkehrsmitteln geeignet



- Automatische Kolbenrückführung
- 2 Absenkenventile mit Geschwindigkeitskontrolle unter Belastung
- Mit zwei Verlängerungen (70 und 120 mm) geliefert

TECHNISCHE DATEN

Tragfähigkeit: 60-30-15 t
Gewicht: 56 kg
Versorgungsdruck: 8-10 bar
Luftverbrauch: 600 l/min

3067/60-15T € 5.240,00 1 030670120

3067/70-13T

Lufthydraulischer Wagenheber, 70-43-23-13 t



- Lange Version, Verwendung an LKWs, Gelenkfahrzeugen, Bussen und landwirtschaftlichen Maschinen
- automatische Kolbenrückführung
- 2 Absenkenventile mit Geschwindigkeitskontrolle unter Belastung

TECHNISCHE DATEN

Max. Gewicht: 70-43-23-13 t
Gewicht: 74 kg
Versorgungsdruck: 8-10 bar
Luftverbrauch: 600 l/min

3067/70-13T € 6.600,00 1 030670130

3068

Handgabelhubwagen mit reduzierten Gabeln



Technische Daten:

- Maximale Tragkraft: 2500 kg
- Gesamtlänge: 1200 mm
- Länge Gabeln: 800 mm
- Breite Gabeln: 540 mm
- Breite einzelne Gabel: 160 mm
- Höhe Hebel: 1230 mm
- Maximale Hebehöhe: 115 mm

3068 € 939,00 1 030680000

3069

Handgabelhubwagen



Technische Daten:

- Maximale Tragkraft: 2500 kg
- Gesamtlänge: 1550 mm
- Länge Gabeln: 1150 mm
- Breite Gabeln: 540 mm
- Breite einzelne Gabel: 160 mm
- Höhe Hebel: 1230 mm
- Maximale Hebehöhe: 115 mm
- Arbeitsgangbreite bei Palette 800x1200 mm längs: 1805 mm
- Wenderadius: 1347 mm

3069 € 883,00 1 030690000



MOTORRAD- WERKZEUGE

Die Werkzeugfamilie von Beta für die Motorreparatur umfasst spezielle Produkte für den Motorradsektor. Eine ständige Verbesserung der Produktqualität wird von Technikern der besten Rennteams bei den Motorrad-Weltmeisterschaften, Superbike- Weltmeisterschaften, Motocross- und Enduro- Weltmeisterschaften hoch geschätzt.



3040C

Hinterer Ständer für Motorrad, verstellbar 

- Mattschwarze Lackierung
- 4 thermoplastische Gummiräder
- Beinhaltet ein Paar Schieber V-Form
- Beinhaltet ein Paar Schieber L-Form



3040C € 94,50 1 030400002

3040C/S1

V-Adapter-Paar für Art. 3040C 



3040C/S1 € 15,00 1 030400503

3040C/S2

L-Adapter-Paar aus Gummi für Art. 3040C 



3040C/S2 € 21,70 1 030400504

3041C

Vorderer Ständer für Motorrad, verstellbar 

- Mattschwarze Lackierung
- 4 thermoplastische Gummiräder
- Beinhaltet ein Rollenadapterpaar
- Beinhaltet ein Kegeladapterpaar



3041C € 88,00 1 030410002

3041C/12

Rollenadapterpaar für Art. 3041C 



3041C/12 € 20,90 1 030410512

3041C/16

Kegeladapterpaar
für Art. 3041C



3041C/16	€ 14,30	1	030410516
----------	---------	---	-----------

3042C

Vorderer Ständer
für Motorradlenkrohr

- Mattschwarze Lackierung
- 4 thermoplastische Gummiräder
- Beinhalteret Kit mit 8 Bolzen Ø 13 - 15 - 15,5 - 17 - 19 - 20 - 21 - 27



3042C	€ 160,00	1	030420002
-------	----------	---	-----------

3043C

Einradmotorradständer links

- Mattschwarze Lackierung
- 4 thermoplastische Gummiräder
- Bolzen fakultativ



3043C	€ 117,00	1	030430002
-------	----------	---	-----------

3043C/ 41÷47

Bolzen
für Art. 3043C



	Ø mm	€		
3043C/41 Ducati	21,5 ÷ 25,5	26,50	1	030430551
3043C/42 KTM - Triumph	27,5	26,50	1	030430552
3043C/43 MV	42,5	29,00	1	030430553
3043C/44 Ducati	40,5	29,00	1	030430554
3043C/45 Honda	28,5	26,50	1	030430555
3043C/47 BMW	53,5	34,00	1	030430557

3047C

Cross/Enduro-Pedalständer



3047C	€ 73,50	1	030470002
-------	---------	---	-----------

3048C

Ständer Cross Racing aus Stahl

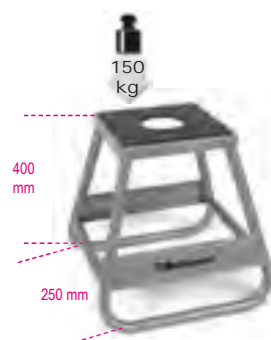

3048C	€ 73,50	1	030480002
-------	---------	---	-----------

3050/CC

Schraub-Mittelständer unter Untergestellwiege
für Custom, Enduro, Cross, Scooter



Beinhaltet Kit verstellbare Halterungen

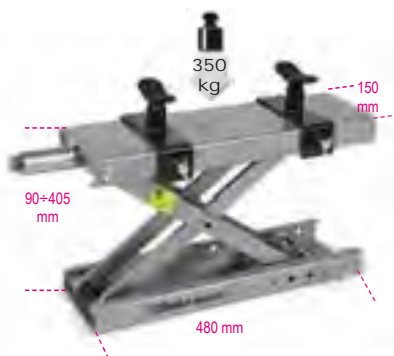

3050/CC	€ 190,00	1	030500012
---------	----------	---	-----------

3050/600

Elektrohydraulische Motorrad-Hebebühne 600
kg

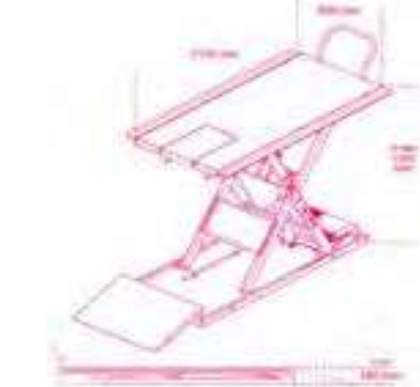
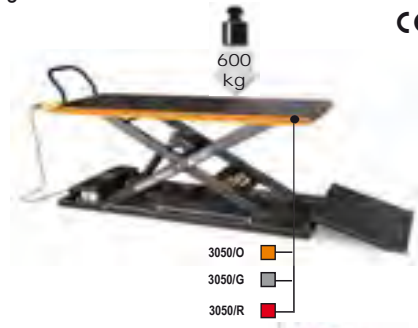

- Technische Eigenschaften
- elektrische, mechanische und hydraulische Sicherheitsvorrichtungen
 - Tragfähigkeit: 600 kg
 - Integriertes elektrohydraulisches Steuergerät: 230V - 50 Hz
 - Hydraulikpumpe
 - geregelte Absenkgeschwindigkeit
 - Sicherheitsventil mit Ölflusssperre bei unabsichtlichen Durchschneiden der Leitung
 - Steuertastentafel
 - zertifiziert c€ TÜV-Zulassung

	L	L	H min	H Max	€		
	mm	mm	mm	mm			
3050/O	975	2100	185	1110	6.390,00	1	030500201
3050/G	975	2100	185	1110	6.390,00	1	030500202
3050/R	975	2100	185	1110	6.390,00	1	030500203

3050/KA

Verbreiterungs-Kit für Hebebühne Art.
3050/600

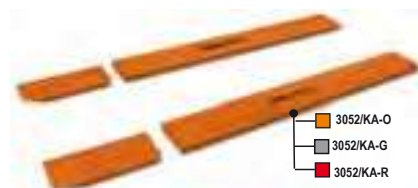

	A	B	€		
	mm	mm			
3050/KA-O	107,5	2100	1.280,00	1	030500221
3050/KA-G	107,5	2100	1.280,00	1	030500222
3050/KA-R	107,5	2100	1.280,00	1	030500223

3050/MS

Radklemme für Heber Art. 3050/600



Ermöglicht das Einspannen des Vorderrades des Motorrades
auf der Hebebühne



3050/MS	€ 726,00	1	030500032
---------	----------	---	-----------



3050/MV

Mechanische Motorrad-Radklemme für Motorrad-Hebebühne Art. 3050/600



3050/MV € 1.260,00 1 030500034

3050/LA

Plattform aus rutschfestem Blech für Hebebühne Art. 3050/600

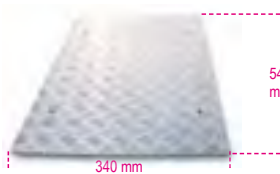

3050/LA € 146,00 1 030500062

9562T1

Werkstattteppich, 100X80 cm

Besonders geeignet für die Nutzung unter Motorrad-Reifenhebern BETA Art. 3071 und Art. 3071B
• Leicht zu säubern, Bodenseite aus Gummi, rutschfest



9562T1 L cm 100 H cm 80 € 100,00 1 095620150

9562T3

Werkstattteppich
Abmessungen: 300x160 cm

- Besonders geeignet für die Nutzung unter Motorradhebebühnen
- Schützt den Boden vor Öl- und Benzinleckagen und schützt die Umwelt
- Leicht zu säubern, Bodenseite aus Gummi und rutschfest



9562T3 L cm 300 H cm 160 € 396,00 1 095620300

3054

Mobile Basis für Mittelständer oder für Hinterrad mit Verlängerung für Seitenständer



3054 max kg 500 € 320,00 1 030540000

3055M

Automatischer Schraubstock für Transporter

Ermöglicht die Befestigung des Vorderrads des Motorrads



3055M € 122,00 1 030550002

3057

Rampe aus Aluminium zum Laden/Entladen des Motorrads



3057 € 259,00 1 030570001

3070B

Manuelle statische Auswuchtmaschine



-ermöglicht das Auswuchten der Räder in der Werkstatt und auf dem Rennfeld
- ausgestattet mit Wälzlagern, Wasserwaage und verstellbare Füßen für maximale Präzision
- beinhaltet Kegelpaar für Radnaben

3070B € 152,00 1 030700100

3070B/...

Auswuchtstange für Auswuchtmaschine Art. 3070B



	Ø1	Ø2	L	€		
3070B/10	30	10	410	27,00	1	030700101
3070B/12	30	12	415	32,00	1	030700102
3070B/14	40	14	415	39,00	1	030700103

3070BE/K

Tragbare elektronische Auswuchtmaschine mit manuellem Anlauf

Mikroprozessorunterstütztes Auswuchtssystem mit manuellem Anlauf (ohne Motor) für das Auswuchten von Eisen- oder Leichtmetallrädern für Auto und Motorrad

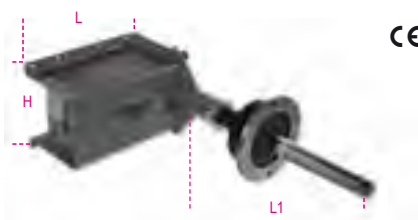

- Kompakt und leicht transportierbar, das System kann in der Werkstatt, in Transportern oder in Boxen der Rennstrecken verwendet werden
- Kann an Werkbank oder Wand befestigt werden
- Die Software enthält alle Korrekturprogramme von Unwuchten mit Angaben der Positionen mit Haftgewichten (ALUS), hinter den Speichern versteckte Gewichte (SPLIT) und Unwuchtoptimierung
- kann mit schwenkbarer Halterung BETA 3070BE/S verwendet werden (optional)

INKLUSIVES ZUBEHÖR

- flexibles Maßlineal
- Spannmutter mit Handrad und 3 Konen Ø 45 + 110 mm

TECHNISCHE DATEN

Spannungsversorgung: 115-230V AC o 12-24V DC
Maximale Leistungsaufnahme: 0,15 kW
Auswuchtgeschwindigkeit: 100 U/Min
Messunsicherheit: 1 g
Einstellbare Felgenbreite: 1.5" + 20" (40+ 510 mm)
Max. Radgewicht: 75 kg

3070BE/K € 3.820,00 1 030700250

3070BE/S

Schwenkbare Halterung für tragbare elektronische Auswuchtmaschine Art. 3070BE

Ermöglicht die Befestigung der Auswuchtmaschine an Wand oder Werkbank, wodurch der Raumbedarf und die Installationsplätze reduziert werden



3070BE/S L mm 514 L1 mm 280 € 1.400,00 1 030700201

3070BE/F

Universalfiansch Motorräder Ø 40 mm für Art. 3070BE

Verwendbar an Rädern mit Mittelbohrung Ø von 15 mm bis 35 mm und an geflanschten Rädern mit Zentrierung bis zu Ø 68 mm



3070BE/F	€	1.905,00	1	030700202
----------	---	----------	---	-----------

3070BE/B

Kit 8 Buchsen für Zentrierung von Motorrädern für Art. 3070BE

Ermöglicht das Arbeiten an folgenden Durchmessern Ø: 28 - 25 - 22 - 20 - 19,05 - 17 - 16 - 15



3070BE/B	€	2.120,00	1	030700203
----------	---	----------	---	-----------

3071A

Manueller Reifenheber für Motocross- und Enduro-Motorräder

Zum einfachen und schnellen Ausbau der Reifen an Rennstrecken. Aufgrund des robusten und breiten Aufbaus aus verzinktem Stahl wird hohe Stabilität beim Reifenausbau gewährleistet. Für eine praktischere Anwendung an der Halterung BETA Art. 3071RS montierbar.

Eigenschaften:

- Ergonomischer Gummigriff für einen angenehmen und sicheren Halt
- Gummifeststeller zur Blockierung der Stange beim Transport
- Einbau von Motocross- und Enduro-Reifen (17" ÷ 21") möglich.

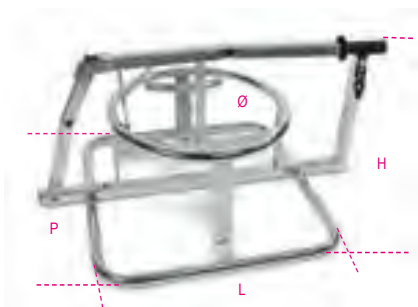

3071A	L	H	P	Ø	€	1	030710000
	mm	mm	mm	mm	588,00		

3071B

Manueller Reifenheber für Mini- und Mini-Motocross-Motorräder

Zum einfachen und schnellen Ausbau der Reifen an Rennstrecken. Aufgrund des robusten und breiten Aufbaus aus verzinktem Stahl wird hohe Stabilität beim Reifenausbau gewährleistet. Für eine praktischere Anwendung an der Halterung BETA Art. 3071RS montierbar.

Eigenschaften:

- Ergonomischer Gummigriff für einen angenehmen und sicheren Halt
- Einbau aller gängigen Mini- und Mini-Motocross-Motorräder möglich.

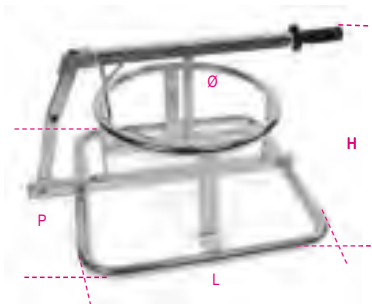

3071B	L	H	P	Ø	€	1	030710010
	mm	mm	mm	mm	550,00		

3071RS

Halterung für Reifenheber BETA Art. 3071A und Art. 3071B

Zur Verwendung mit den Reifenhebern BETA Art. 3071A und Art. 3071B für einen einfachen Ausbau. Aufgrund des Aufbaus aus verzinktem Stahl mit viereckigem Sockel wird hohe Stabilität gewährleistet.

- Mit 4 Befestigungshaken

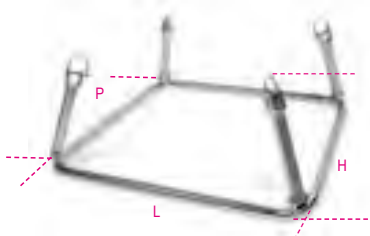

3071RS	L	H	P	€	1	030710020
	mm	mm	mm	256,00		

962C

Reifenheberpaar für Motocross-, Enduro-, Mini- und Mini-Motocross-Motorräder

Zur Verwendung mit den Reifenhebern BETA Art. 3071A und Art. 3071B



962C	L	A	€	1	009620020
	mm	mm	136,00		

3072N

Manuelles Werkzeug zum Stoßdämpferausbau hinten für Motorräder

Ermöglicht den sicheren Ausbau der hinteren Motorrad-Stoßdämpfer. Aufgrund der verstellbaren Arme ist dieses Werkzeug für alle gängigen hinteren Stoßdämpfer geeignet; andernfalls kann die mitgelieferte Platte verwendet werden. - Sperrringe (nicht im Lieferumfang enthalten)

Eigenschaften

- Für alle gängigen hinteren Motorrad-Stoßdämpfer geeignet
- 8-fach höhenverstellbar
- 3 verstellbare Arme mit höhenverstellbaren Feststellstiften
- Stoßdämpfer-Blockierplatte
- Mit Scherenwagenheber
- Mit Gummifüssen
- Mit Stoßdämpfer-Blockierstift

Technische Daten

Ausdehnung Wagenheber: max. 130 mm
Ausdehnung Arme: max. 55 mm
Ausdehnung Blockierstifte: max. 18 mm
Schubleistung: max. 1 t



3072N	L	H	P	€	1	030720010
	mm	mm	mm	1.325,00		

3073

Universeller Gabeldichting-Eintreiber

Für Schaftdurchmesser von 35 bis 48 mm

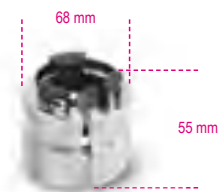

3073	€	102,00	1	030730001
------	---	--------	---	-----------

30740

Schlüssel für elektronische Ölins-Gabelkappen

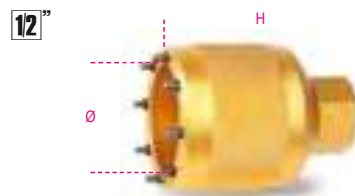

30740	H	Ø	€	1	030740001
	mm	mm	119,00		

30740/S

Gabelschlüssel Sachs
auf DUCATI Multistrada

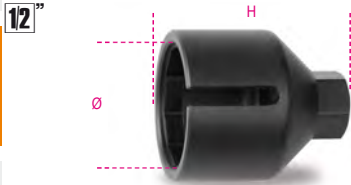

30740/S	H mm	Ø mm	€	1	030740002
	75	65	134,00		

30740/M

Marzocchi-Gabelschlüssel
für DUCATI 1199 und Hypermotard

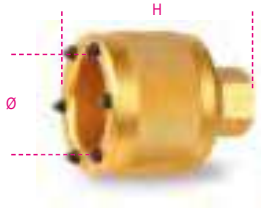

30740/M	H mm	Ø mm	€	1	030740003
	69	55	117,00		

30740/2

Öhlins-Gabelschlüssel für DUCATI
mit 8-kant

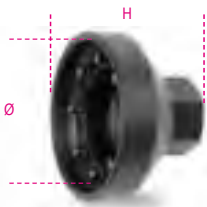

30740/2	H mm	Ø mm	€	1	030740004
	45	65	123,00		

3075A

Sechskant-Steckschlüssel
für Radnabenmutter

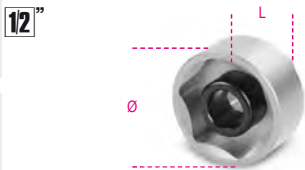

3075A 28	Ø mm	L mm	€	1	030750028
3075A 30	30	40	35,00	1	030750030

3075B

Zwölfkant-Steckschlüssel
für Radnabenmutter

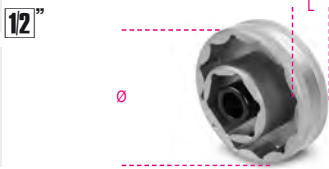

3075B 55	Ø mm	L mm	€	1	030750155
	55	70,7	84,00		

3075MV

Zwölfkant-Steckschlüssel für
Radnabenmutter MV AGUSTA



3075MV 56	Ø mm	L mm	€	1	030750156
	56	70,7	94,50		

3075/CM

Mehrfach-Sechskantstiftschlüssel
für Radbolzen



3075/CM	€	1	030750212
12-14-17-19-22-24 mm	47,50		

3075/K10

Set Universalschlüssel mit austauschbaren
Köpfen und 10 Einsätzen, zum Anziehen von
Radspeichen



Maße: 5.2 - 5.4 - 5.6 - 5.8 - 6.0 - 6.2 - 6.4 - 6.6 - 6.8 - 7.0



3075/K10	€	1	030750410
	63,00		

3079/21

Kabelöler



Ermöglicht eine korrekte Schmierung
der Kupplungskabel und der Gassteuerung, wodurch die
Gleitfähigkeit der Hüllen und die Nutzungsdauer der Kabel
erhöht werden.



3079/21	€	1	030790021
	9,70		

3080/C15

Satz zum Gliedentfernen und Vernieten von
Ketten
Ø 3-4-5 mm + Regina-Satz



3080/C15	€	1	030800015
420x185x60 mm	421,00		

3080R/CS3

Kit 3 Ersatzsplinttreiber für Kettennietdrücker
Art. 3080/C15



Ø 3-4-5 mm



3080R/CS3	€	1	030800503
	64,50		

3081

Tragbarer Kettennietdrücker



Robust und zusammenklappbar, um den Transport in der
Endurotasche zu erleichtern.
Geeignet für Ketten 415, 420, 428, 520, 525, 530, 532



3081	€	1	030810010
	52,50		

3085

Bremskolben-Abziehwerkzeug



Geeignet für Bremskolben Motorrad und Scooter



3085	€	1	030850010
	117,00		

3091

Schwungrad-Abzieher mit Innengewinde



	M	€		
3091/10	24x1,5	24,50	1	030910010
3091/20	26x1,0	26,00	1	030910020
3091/25	27x1,0	26,00	1	030910025
3091/30	28x1,0	26,00	1	030910030
3091/40	30x1,0	34,50	1	030910040
3091/45	30x1,5	34,50	1	030910045
3091/50	32x1,5	38,00	1	030910050
3091/60	33x1,5	39,50	1	030910060
3091/70	35x1,0	56,00	1	030910070
3091/75	35x1,5	56,00	1	030910075
3091/80	38x1,5	61,00	1	030910080

3092

Schwungrad-Abzieher mit Außengewinde



	M	€		
3092/10	18x1,5	13,00	1	030920010
3092/20	19x1,0	15,10	1	030920020
3092/25	27x1,0	15,80	1	030920025
3092/30	27x1,25/20x1	15,90	1	030920030
3092/35	22-26x1,5	15,90	1	030920035
3092/40	25x1,5/22x1	15,90	1	030920040
3092/50	26-28x1,0	15,90	1	030920050
3092/60	28x1,5	15,70	1	030920060

3093/E

Werkzeug zur Blockierung des Schwungrads, Kupplungsglocke und Riemenscheiben



	€		
3093/E	43,00	1	030930100

3093/U

Mehrfach-Schwungradabzieher



	€		
3093/U	41,50	1	030930050
M10x1.25R			
M14x1.5R			
M16x1.5R			
M18x1.5R			
M24x1.0R			
M27x1.0L			

3094PA

Werkzeugpaneel OFFROAD für Wartung und Reparatur von Motorrädern

Metallrahmen mit einklappbaren Beinen, geeignet für die Anordnung von Werkzeugen an Rennstrecken, in 3 Farben erhältlich:

- 3094PA-O Orange
- 3094PA-G Grau
- 3094PA-R Rot

Nicht im Lieferumfang enthaltenes Zubehör:

- Papierrollenhalter für vorgestanzte Rollen Art. 3200 PR
- Magnetischer Universalfaschenhalter Art. 2499PF/M



	L	H	H1	€		
	mm	mm	mm			
3094PA-O	750	1555	900	613,00	1	030940101
3094PA-G	750	1555	900	613,00	1	030940102
3094PA-R	750	1555	900	613,00	1	030940103

3095

Werkbankhalterung für Motorradmotoren

Die verstellbaren Bügel ermöglichen praktische, mühelose Werkbankarbeiten an den Motoren



	H	P	L	L1	€		
	mm	mm	mm	mm			
3095	360	460	640	460	691,00	1	030950001

3099E

Motorschutzdecke für den Aussenbereich, wasser- und staubbeständig

Schützt den Lack vor Kratzern, Staub und Sonnenlicht



Größe "M" ist geeignet für Sportmotorräder, Naked-Bikes und mittelgroße Roller
Größe "L" ist geeignet für Maxi-Enduros und Crossover-Bikes

		€		
3099E/M	M	97,50	1	030990102
3099E/L	L	121,00	1	030990103

3099T

Motorschutzdecke für den Innenbereich, aus Stretch-Gewebe

Schützt den Lack vor Kratzern, Staub und Sonnenlicht



Größe "M" ist geeignet für Sportmotorräder, Naked-Bikes und mittelgroße Roller
Größe "L" ist geeignet für Maxi-Enduros und Crossover-Bikes
Größe "XL" ist geeignet für Super-Touring-Bikes

		€		
3099T/M	M	85,00	1	030990202
3099T/L	L	104,00	1	030990203
3099T/XL	XL	126,00	1	030990204



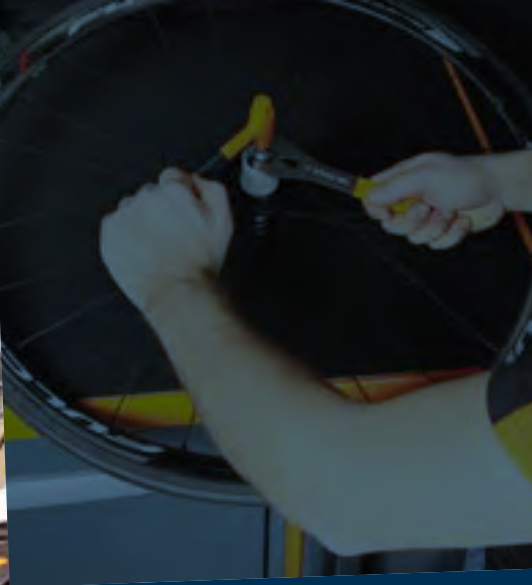

FAHRRAD- WERKZEUGE

Beta ist seit jeher dem Radsport verbunden. Die in diesem Abschnitt behandelten Werkzeuge richten sich an Fachleute der Branche und ist eine sorgfältige Auswahl spezifischer Produkte für die Wartung von Fahrrädern und E-Bikes.



Tour de France 2020 and 2021



Partnership 2023

*Official contributor
of Eolo KOMETA cycling*



Partnership 2023



3910 E-Bike-Heber



- Maximale Tragfähigkeit: 40 kg
- Maximale zentrale Tretlagerhöhe: 135 cm
- Eingebauter Radzentrierständer
- Innovatives Sperrsystem mit Durchsteckbolzen
- Inklusive Adapter für alle gängigen Gabeln
- Inklusive Adapter für Gabelbefestigung ohne Durchsteckbolzen
- Vollkommen zusammenklappbar und transportfähig
- Gewicht des Hebers: 48 kg

CE

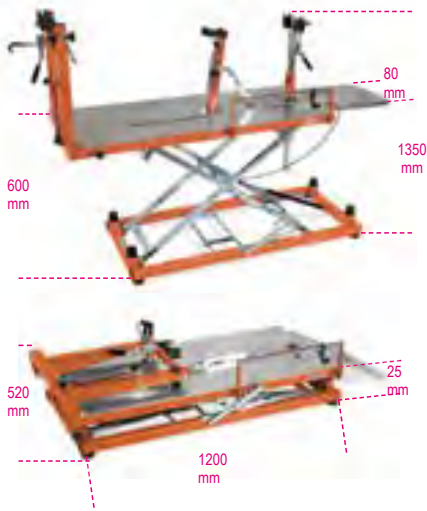

3910 € 4.210,00 1 039100010

3912TP Werkstattbank TOP für Fahrradwartung



- Ausgestattet mit Halterung für Tretlager mit Sicherheitsstift
- Werkzeugschublade mit kugelgelagerten Führungen, 490x365x90 mm
- Eingebauter Radzentrierständer
- Innovatives Blockierungssystem mit Durchgangsstift



3912TP € 1.745,00 1 039120050

3912PP Werkstattbank PRO für Fahrradwartung



- Ausgestattet mit Halterung für Tretlager mit Sicherheitsstift
- Eingebauter Radzentrierständer
- Innovatives Blockierungssystem mit Durchgangsstift



3912PP € 949,00 1 039120150

3912TP/A Adaptersteckschlüssel für Gabeln mit Durchgangsstift



Für Werkbänke Art. 3912TP, Art. 3912PP und Art. 3910



L mm 39 Ø mm 30 Ø1 mm 5 € 23,30 1 039120052

3912TP/C Universaladaptersteckschlüssel für Gabeln mit Durchgangsstift und Anziehen mit Sechskantschlüssel



Für Werkbänke Art. 3912TP, Art. 3912PP und Art. 3910



L mm 29 Ø mm 30 € 23,30 1 039120054

3912TP/FOX Adaptersteckschlüssel für FOX® Gabeln



Für Werkbänke Art. 3912TP, Art. 3912PP und Art. 3910



L mm 38 € 23,30 1 039120058

3912TP/QRE Adapterstift für Gabeln ohne Durchgangsstift



Für Werkbänke Art. 3912TP, Art. 3912PP und Art. 3910



L mm 108 € 38,50 1 039120064

3912TP/ROAD Adaptersteckschlüssel für Straßengabeln



Für Werkbänke Art. 3912TP, Art. 3912PP und Art. 3910



L mm 33 Ø mm 35 € 26,00 1 039120060

3912TP/RS Adaptersteckschlüssel für ROCKSHOX® Gabeln mit Durchgangsstift



Für Werkbänke Art. 3912TP, Art. 3912PP und Art. 3910



L mm 35 Ø mm 30 € 23,30 1 039120056

3912TP/ST Adaptersteckschlüssel für SUNTOUR Gabeln



Für Werkbänke Art. 3912TP, Art. 3912PP und Art. 3910



L mm 31 Ø mm 30 Ø1 mm 18 € 26,00 1 039120062



3916MMP

Einzelarm-Werkstattschraubstock für
Fahradwartung

- 360° Drehschraubstock mit schwimmenden Backen und mikrometrischer Einstellung
- Tragfähigkeit: 25 kg
- Kunststoff-Werkzeugaufnahmeschale



3916MMP € 855,00 1 039160150

3918MML

Halteklau mit einem Montagearm, leicht,
zusammenklappbar

- Um 360° drehbare Halteklau
- Tragfähigkeit: 15 kg
- Max. Höhe der Halteklau: 150 cm



3918MML € 350,00 1 039180010

3921

Schaltauge-Richtwerkzeug

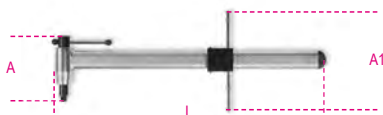

L mm 440 A mm 115 A1 mm 165 € 122,00 1 039210010

3923

Werkzeug Blattführung zum Schneiden der
Sattelstütze Typ aerodynamisch bis zu 80 mm
und Schneiden von Rohren von 1" bis 1.1/2"

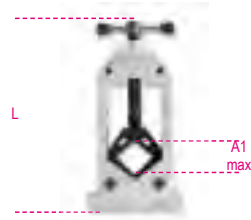

L mm 160 A1 max mm 80 Ø max mm 45 € 57,50 1 039230010

3927

Lenkerblockierung



3927 L mm 365 € 34,50 1 039270010

3932U

Profi-Kettenwerkzeug kompatibel
mit Ketten von 5 bis 11 Gängen



L mm 164 L1 mm 115 € 63,50 1 039320011

3935

Kettenverschleißanzeige



L mm 120 € 10,90 1 039350010

3937

Zange für Kettenschloss



L mm 170 € 28,00 1 039370010

3948

Tretkurbelabzieher

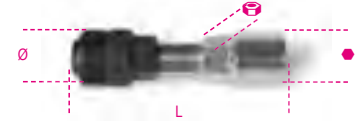

mm 14 L mm 79 Ø mm 20 mm 15 € 21,80 1 039480015

3952

Einfacher Konusschlüssel



mm	L mm	€	U	1
13	205	28,00	2	039520013
14	205	28,00	2	039520014
15	205	28,00	2	039520015
16	205	28,00	2	039520016
17	205	28,00	2	039520017
18	205	28,00	2	039520018
19	205	28,00	2	039520019
20	205	28,00	1	039520020
21	205	28,00	1	039520021
22	205	28,00	1	039520022
24	205	30,00	1	039520024



€	U	1
196,00	1	039520207
311,00	1	039520211

3953

Pedalschlüssel



mm 15 L mm 401 € 44,00 1 039530015

3955

Maulschlüssel für Universal-Steuersätze



mm	L mm	€	U	1
30x32	292	40,00	1	039550108
32x36	319	45,00	1	039550114

3961 3,2

Speichenzieher, schwarz, 3,2 mm



mm 3,2 € 15,90 1 039610032

3961 3,3
Speichenzieher, grün, 3,3 mm



mm
3,3 € 15,90 1 039610033

3961 3,5
Speichenzieher, rot, 3,5 mm



mm
3,5 € 15,90 1 039610035

3961U
Profi-Speichenzieher, 3,2 - 4,0 mm



mm
3,2 - 4,0 € 26,00 1 039610100

3962SH
Doppel-Speichenzieherschlüssel für Shimano



L mm 132 A1 mm 4,3 A2 mm 4,4 € 20,10 1 039620010

3962MV
Doppel-Speichenzieherschlüssel für Mavic



L mm 135 A1 mm 4,3 A2 mm 8,4 € 20,90 1 039620020

3963P
Spezienschlüssel für flache Speichen

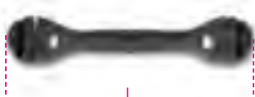

L mm 129 € 9,60 1 039630010

3964
Spezienschlüssel Nippelschrauber



L mm 170 L1 mm 89 € 23,60 1 039640010

3965
Schablone für Sprungkontrolle Räder 20"-29"



L mm 680 € 116,00 1 039650010

3965C
Professionelles Werkzeug für Fadenkreuzkontrolle



- Für Durchmesser von 20" bis 29"
- Adapter für Durchgangsachsen zwischen 10 mm und 20 mm

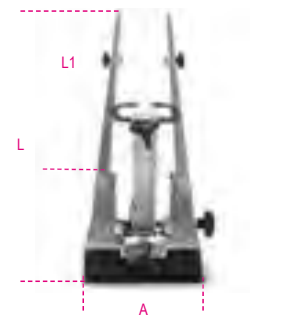

L mm 500 L1 mm 380 A mm 285 € 465,00 1 039650110

3967
Schlüssel Ritzelpeitsche Kettenabnehmer



- Kompatibel mit Kassetten bis zu 11 Gängen
- Griff aus 2PVC
- Auch für Fixie Räder



L mm 289 € 63,00 1 039670010

3969
Reifenheber



L mm 200 A mm 15,6 € 11,70 1 039690010

3969K3
Kit 3 Reifenheber, aus Kunststoff



L mm 113 € 6,60 1 039690130

3971
Schlüssel für Kunststoffschraube Shimano



- Geeignet für Kurbelgarnitur Shimano Hollowtech II



N° 8 mm 8 € 14,10 1 039710010

3972
Abzieher Schlüssel für Tretlager



- Geeignet für Shimano® Hollowtech II, Campagnolo® Ultra-torque, FSA®, SRAM®



L mm 252 € 27,50 1 039720010

3973PF
Abzieher für Press-Fit Lager



- Geeignet für Innen-Ø 24 mm bis 30 mm



L mm 240 € 36,50 1 039730001

3973/1
Abzieher Steckschlüssel für Tretlager mit 16 Kerben



- Geeignet für Shimano® XTR BB93, Dura-Ace® BB9000

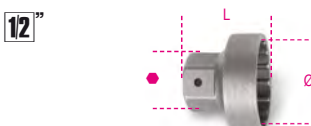

Ø mm 39 mm 24 L mm 34 € 23,40 1 039730010

3973/2

Abzieher Steckschlüssel für Tretlager mit 16 Kerben

• Geeignet für Shimano® BBR60 (Ultegra® 11 Gänge)

12"



Ø mm	mm	L mm	€	1	039730020
41	24	35	23,40		

3973/3

Abzieher Steckschlüssel für Tretlager mit 16 Kerben

• Geeignet für Shimano® Hollowtech II, Campagnolo® Ultra-torque, FSA®, SRAM®

12"



Ø int. mm	mm	L mm	€	1	039730030
46	24	53,5	23,40		

3973/4

Abzieher Steckschlüssel für Tretlager mit 20 Kerben, mit Zentralstift, vernickelt

• Geeignet für Shimano und ISIS

12"

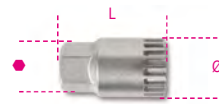

Ø mm	L mm	mm	€	1	039730040
31,5	55	24	14,80		

3975

Presse für die Montage von Steuersätzen und Tretlager

• Geeignet für die Montage von Steuersatzkappen mit 1", 1.1/8", 1.1/4", 1.1/2" und 2"

HINWEIS: Für „Zero stack“-Kappen ungeeignet



L mm	Ø mm	€	1	039750010
360	16x1	309,00		

3984/1

Abzieher Schlüssel für 4-Gang-Freilauf BMX

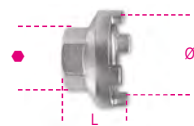

Ø mm	L mm	mm	€	1	039840010
35	25,5	24	17,20		

3984/2

Abzieher Schlüssel für Freilauf Shimano



Ø mm	L mm	mm	€	1	039840020
22,8	26	24	10,90		

3984/3

Abzieher Schlüssel für Kassetten-Freilauf Shimano mit Führungsstift

12"

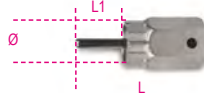

Ø mm	L mm	L1 mm	€	1	039840030
23,5	65	25	18,70		

3984/4

Abzieher Schlüssel für Freilauf Campagnolo mit Führungsstift



Ø mm	L mm	L1 mm	mm	€	1	039840040
23	51	13	24	24,50		

3984/5

Abzieher Schlüssel für 2-Gang-Freilauf

12"



Ø mm	L mm	mm	€	1	039840050
18,5	38	21	17,20		

3984/6

Abzieher Schlüssel für 4-Gang-Freilauf

12"



Ø mm	L mm	mm	€	1	039840060
19,5	36	21	17,20		

3991

Hebel zum Zurückziehen von Scheibenbremsenbelag



L mm	A mm	α	€	1	039910010
222	36	7°	41,00		

3992

Schlüssel zum Richten von Brems Scheiben



L mm	A1 mm	€	1	039920010	
234	4 55	2,2	30,50		

2115PI/BIKE-HOME



2115PI/BIKE-HOME	361
------------------	-----

M400



M400	543
MV400	543

M401



M401	543
MV401	543

MM400



MM400	548
MMV400	548

MM401



MM401	548
MMV401	548



VDE- WERKZEUGE

Bei der Entwicklung der von Beta produzierten isolierten Werkzeuge stand die Sicherheit von Installateuren und Elektrikern im Vordergrund. Alle isolierten Werkzeuge ermöglichen das Arbeiten an Anlagen unter Spannung bis 1000 V Wechselstrom und 1500 V Gleichstrom. Zur Gewährleistung maximaler Qualität sowie Leistung und zur Sicherstellung der Eignung und Übereinstimmung mit der Norm 60900 wurde jedes einzelne Werkzeug einer umfassenden Prüfung unterzogen. Diese besteht aus: Widerstandsfähigkeit des Griffs gegen ein Herausrutschen und Flammenfortpflanzung sowie einer auf 10000 Volt angewandten Spannungsprüfung.

Für Sortimente und Thermoformateinsätze siehe die entsprechenden Abschnitte.

Alle isolierten Werkzeuge von Beta sind unter Beachtung der Vorschriften der Norm EN60900 hergestellt und von den besten europäischen Zertifikationsbehörden zugelassen.



Istituto Italiano del Marchio di Qualità - I



Verband der Elektrotechnik
Elektronik Informationstechnik - D

1000 V

SICHERHEITSTEST: Getestet mit 10.000 Volt für die Arbeit an 1.000 Volt Anlagen

Die isolierten Werkzeuge von Beta werden Stück für Stück mit 10kV getestet, mit dem Ziel, eine absolut sichere Qualität für Arbeitsgeräte zu bieten, die höchste Sicherheitsstandards garantieren müssen.

Sie sind zugelassen für die Arbeit an Anlagen, die unter einer Spannung bis zu 1000 Volt AC (1500 Volt DC) stehen.

SICHERHEITSVORSCHRIFTEN:

Trotz der sehr sorgfältigen Kontrollen während der Herstellung, muss der Bediener vor dem Gebrauch stets den isolierten Griff auf eventuell vorhandene Risse, Änderungen, Beschädigungen oder Verschleiß prüfen.

Die Beibehaltung der dielektrischen Eigenschaften ist abhängig von den mechanischen, chemischen oder thermischen Belastungen, denen das Werkzeug ausgesetzt ist.

Bei Abnutzung der Isolierung ist das Werkzeug nicht sicher für die Verwendung an unter Spannung stehenden Anlagen. Immer Schutzbrillen und Isolierhandschuhe tragen.

DURCHGEFÜHRTE KONTROLLEN WÄHREND DER HERSTELLUNGSPHASE



100% Sichtprüfung:

Die Oberflächen der Werkzeuge dürfen keine äußerlich sichtbaren Fehler aufweisen.



Schlagprüfung :

Nachdem das Werkzeug 2 Stunden lang einer Temperatur von -25 °C ausgesetzt und somit abgekühlt wurde, darf das Isoliermaterial des Griffs nach 3 Schlägen (mit einem spezifischen normgemäßen Gewicht) nicht brechen oder Beschädigungen aufweisen.



Eindringprüfung :

Am Griff des Werkzeugs wird bei einer Temperatur von +70 °C ein Gewicht von 2 kg angebracht, danach wird an der dem mechanischen Druck ausgesetzten Fläche 3 Minuten lang eine Spannung von 5 kV angelegt. Es darf kein Stromdurchgang auftreten.



Mechanische Prüfung:

Die Werkzeuge müssen alle von den entsprechenden Produkt ISO-Normen vorgeschriebenen mechanischen Leistungen erfüllen.



Prüfen der vertikalen Flammenausbreitung:

Eine Flamme wird 10 Sekunden lang gegen das Werkzeug gerichtet, in den darauffolgenden 20 Sekunden darf die Flamme nicht die Höhe von 120 mm überschreiten.



Maßprüfung :

Alle charakteristischen Maßzahlen der Werkzeuge müssen den Projektspezifikationen entsprechen.

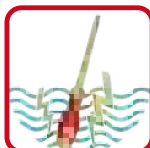

Prüfung der elektrischen Isoliereigenschaft:

Nach einer Unterwasserlagerung von 24 Stunden wird das Werkzeug 3 Minuten lang mit 10 kV bei gleichzeitiger Messung des Ableitstroms getestet, der die von der Norm vorgeschriebenen Werte nicht überschreiten darf.



Prüfung der Haftfähigkeit :

Die Haftfähigkeit des Isolierüberzugs wird nach einer Lagerung von 168 Stunden bei +70 °C mit einer Zugkraft von 500 N geprüft. Der Isolierstoff des Griffs muss fest mit dem Grundwerkzeug verbunden bleiben.

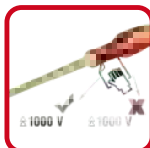

Prüfung der Nichtlöschbarkeit der Kennzeichnung:

Nach dem Scheuertest mit Isopropylalkohol müssen die Kennzeichnungen lesbar bleiben.



52MQ

Einmaulschlüssel



EN 60900

Ø mm	L mm	€	U	IP
6	90	38,00	1	000520106
7	96	38,00	1	000520107
8	100	38,00	1	000520108
9	108	38,00	1	000520109
10	110	38,00	1	000520110
11	120	38,00	1	000520111
12	132	40,00	1	000520112
13	140	43,00	1	000520113
14	146	44,00	1	000520114
15	166	45,00	1	000520115
16	156	49,00	1	000520116
17	168	49,00	1	000520117
18	170	51,00	1	000520118
19	176	51,00	1	000520119
21	190	55,50	1	000520121
22	200	55,50	1	000520122
24	225	59,50	1	000520124
27	210	78,00	1	000520127
30	240	81,50	1	000520130
32	240	83,00	1	000520132

89MQ

Einringschlüssel



EN 60900

Ø mm	L mm	€	U	IP
6	150	48,50	1	000890106
7	155	48,50	1	000890107
8	155	48,50	1	000890108
9	160	48,50	1	000890109
10	170	48,50	1	000890110
11	180	48,50	1	000890111
12	190	53,00	1	000890112
13	195	56,50	1	000890113
14	200	59,50	1	000890114
15	210	61,00	1	000890115
16	216	65,00	1	000890116
17	218	65,00	1	000890117
18	236	69,00	1	000890118
19	240	69,00	1	000890119
21	250	79,50	1	000890121
22	255	79,50	1	000890122
24	280	90,00	1	000890124
27	300	95,50	1	000890127
30	320	112,00	1	000890130
32	340	114,00	1	000890132

110MQ

Einmaulschlüssel, verstellbar, mit Maßskala



EN 60900

L mm	A max	€	U	IP
200	28	97,00	1	001100520
250	30	113,00	1	001100525
300	30	164,00	1	001100530

606MQ/50

Drehmomentschlüssel
mit Signalgebung, mit Umschaltknarre



EN 60900
UNI EN 26789
ISO 6789

Nm	Kgfm	lbf.ft	A mm	L mm	g
5÷50	0,5÷5	4÷40	90	375	1130

606MQ/50 € 938,00 1 006060705

850MQ

VDE-Einsatzhalter, magnetisch,
mit Bimaterial-Griff



IMQ CSV
EN 60900

L mm	L1 mm	D mm	€	1	008500910
233	125	12.5	28,00	1	008500910

910MQ/B

Zwölfkant-Steckschlüssel



EN 60900

Ø mm	L mm	Ø1 mm	Ø mm	€	1	009100616
6	45	14	24	34,50	1	009100616
7	45	15	24	34,50	1	009100617
8	45	16	24	34,50	1	009100618
9	45	17	24	34,50	1	009100619
10	45	19	24	34,50	1	009100620
11	45	20	24	34,50	1	009100621
12	45	24	24	34,50	1	009100622
13	45	24	24	34,50	1	009100623
14	45	25	24	34,50	1	009100624
15	45	27	24	36,50	1	009100625
16	45	27,5	24	36,50	1	009100626
17	45	30	24	37,50	1	009100627
18	45	31	24	37,50	1	009100628
19	45	32	24	37,50	1	009100629

910MQ/PE

Sechskant-Steckschlüssel



EN 60900

mm	Ø mm	L mm	€	1	009100604
4	24	100	39,00	1	009100604
5	24,5	100	39,00	1	009100605
6	25,0	100	39,00	1	009100606
8	25,0	100	39,00	1	009100608
10	25,5	100	40,00	1	009100610

910MQ/TX

Steckschlüssel
für Torx®-Schrauben



EN 60900

Ø mm	L mm	L1 mm	€	1	009100641
T15	23	116	61	49,00	1 009100641
T20	24,5	116	65	49,00	1 009100642
T25	24,5	116	65	49,00	1 009100643
T27	24,5	116	65	49,00	1 009100644
T30	24,5	116	65	50,50	1 009100645
T40	24,5	116	65	51,00	1 009100646

910MQ/XZN

Steckschlüssel
für XZN®-Schrauben

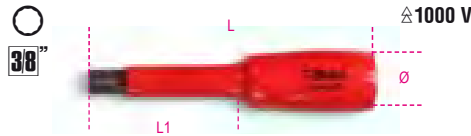

EN 60900

Ø mm	L mm	L1 mm	€	1	009100658
M8	24	106	57	46,00	1 009100658
M10	24	106	57	47,50	1 009100660

910MQ/PT

Vorkalibrierte Verlängerungen
mit Innenvierkant 3/8"



EN 60900

Nm	L mm	L1 mm	€	1	009100801
12	80	35,5	259,00	1	009100801

910MQ/21

Verlängerung Innen- und Außenvierkant 3/8"



EN 60900

L mm	Ø mm	€	1	009100804
140	13,4	62,50	1	009100804

910MQ/22

Verlängerung Innen- und Außenvierkant 3/8"



EN 60900

L mm	Ø mm	€	1	009100805
265	13,4	68,00	1	009100805

910MQ/T

Verlängerung mit Kardangelen,
Außenvierkant 3/8"



EN 60900

L mm	L1 mm	€	1	009100807
200	165	74,50	1	009100807

910MQ/55

Umschaltknarre,
Außenvierkant 3/8"



EN 60900

L mm	D mm	A mm	€	1	009100808
203	41	67	213,00	1	009100808

910MQ/C16

8 Zwölfkant-Steckschlüssel,
4 Sechskant-Steckschlüssel
und 4 Betätigungswerkzeuge



EN 60900

910MQ/C16	€	1	009100917
	928,00	1	009100917

○ 910MQ/B	8 - 10 - 11 - 12 - 13 - 14 - 17 - 19 mm
○ 910MQ/PE	4 - 5 - 6 - 8 mm
910MQ/21	125 mm
910MQ/22	250 mm
910MQ/T	
910MQ/55	

914MQ/A

Sechskant-Steckschlüssel
mit Innenvierkantantrieb 3/8",
aus Glasfaser verstärktem Polymer auf
Polyamidbasis
Spezifisch für Arbeiten an Batterien von Hybrid- und
Elektrofahrzeugen

Mit Drehmomentschlüsseln zu verwenden



EN 60900

Ø mm	L mm	Ø1 mm	€	U	U
8	17,5	45	18,00	2	009140008
10	20,5	45	18,00	2	009140010
13	24	45	18,00	2	009140013
17	30	45	18,00	2	009140017



EN 60900

914MQ-A/S4	€	U	U
8-10-13-17 mm	72,00	1	009140054

920MQ/A

Sechskant-Steckschlüssel



EN 60900

Ø mm	L mm	Ø1 mm	€	U	U
8	21,5	57	34,50	1	009200238
9	21,5	57	34,50	1	009200239
10	21,5	57	34,50	1	009200240
11	21,5	57	34,50	1	009200241
12	23,0	57	34,50	1	009200242
13	23,0	57	34,50	1	009200243
14	23,0	57	35,50	1	009200244
16	23,0	57	36,50	1	009200246
17	30,0	57	36,50	1	009200247
18	32,0	57	37,50	1	009200248
19	32,2	57	37,50	1	009200249
20	32,0	57	42,00	1	009200250
21	34,0	57	42,00	1	009200251
22	36,0	57	42,00	1	009200252
24	39,0	57	43,00	1	009200254
27	42,0	57	43,50	1	009200257
30	44,0	57	45,00	1	009200260
32	48,0	57	46,50	1	009200262

920MQ/PE

Sechskant-Steckschlüssel



EN 60900

	Ø mm	L mm	L1 mm	€	U	U
*4	28,5	94,50	10,5	58,00	1	009200264
*5	28,5	94,5	10,5	58,00	1	009200265
*6	28,5	94,5	10,5	58,00	1	009200266
*8	28,5	94,5	10,5	58,00	1	009200268
10	28,5	94,5	10,5	60,50	1	009200267
12	28,5	94,5	10,5	60,50	1	009200269

920MQ/21

Verlängerung,
Innen- und Außenvierkant 1/2"



EN 60900

L mm	Ø mm	€	U	U
135	28	66,50	1	009200804

920MQ/22

Verlängerung,
Innen- und Außenvierkant 1/2"



EN 60900

L mm	Ø mm	€	U	U
264	30	75,50	1	009200805

920MQ/T

T-Griff mit Außenvierkant 1/2"

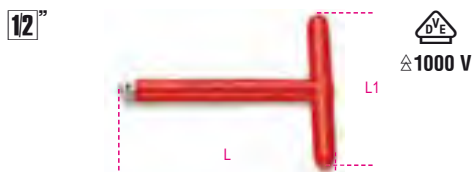

EN 60900

L mm	L1 mm	€	U	U
200	163	79,50	1	009200807

920MQ/55A

Umschaltknarre
mit Außenvierkantantrieb 1/2"



EN 60900

L mm	D mm	A mm	€	U	U
240	50	89	283,00	1	009200809

920MQ/C16

9 Sechskant-Steckschlüssel
3 Sechskant-Steckschlüssel mit Außenvierkant
und 4 Betätigungswerkzeuge



EN 60900

920MQ/C16	€	U	U
	1.083,00	1	009200917

920MQ/A	8 - 10 - 12 - 13 - 14 - 17 - 19 - 22 - 24 mm
920MQ/PE	5 - 6 - 8 mm
920MQ/21	135 mm
920MQ/22	264 mm
920MQ/55A	
920MQ/T	

420x280x60 mm - 5,2 kg

943MQ

Sechskant-Steckschlüssel
mit Griff



EN 60900

Ø mm	L mm	L1 mm	D mm	€	U	U
5,5	233	125	12,2	22,60	1	009430235
6	233	125	12,5	22,60	1	009430236
7	240	125	14,3	23,90	1	009430237
8	240	125	15,3	24,60	1	009430238
10	252	125	17,3	25,50	1	009430240
13	252	125	21,3	27,50	1	009430243



943MQ/S6	€	U	U
5,5-6-7-8-10-13 mm	147,00	1	009430250

951MQ

Sechskant-Stiftschlüssel mit T-Griff



EN 60900

mm	L mm	L1 mm	€	U	U
3	120	105	56,50	1	009510703
* 4	165	105	58,00	1	009510704
* 5	170	105	58,00	1	009510705
* 6	168	105	58,00	1	009510706
* 8	165	105	59,00	1	009510708
10	200	105	61,50	1	009510710

993MQ

Gebogene Pinzette mit abgerundeten Spitzen, gezahnt



EN 60900

L mm	€	Icon	Code
147	47,50	1	009930040

994MQ

Gerade Pinzette mit abgerundeten Spitzen, gezahnt



EN 60900

L mm	€	Icon	Code
145	46,50	1	009940040

1010MQ

Zange mit runden Backen, lang



EN 60900

L mm	L1 mm	€	Icon	Code
160	51,5	57,00	1	010100096

1048MQ

Verstellbare Zangen mit Tasteneinstellung

• Verchromt



EN60900

L mm	A max mm	L1 mm	€	Icon	Code
250	48	39	84,00	1	010480315

1082MQ

Diagonalseitenschneider



EN 60900

L mm	L1 mm	mm	€	Icon	Code
140	20	1,6	56,50	1	010820094
160	22	1,6	59,00	1	010820096

1084MQ

Diagonalseitenschneider für geringen Kraftaufwand



EN 60900

L mm	L1 mm	mm	€	Icon	Code
200	26	2,0	74,50	1	010840100

1088MQ

Vornschneider



EN 60900

L mm	L1 mm	mm	€	Icon	Code
160	7	1,6	70,50	1	010880096

1128MQ

Elektrikerschere, Schneiden aus rostfreiem Stahl, mit Mikroverzahnung



IEC60900

L mm	L1 mm	€	Icon	Code
145	45	58,50	1	011280101

1132MQ

Kabelschneider mit isolierten Griffen, zum Schneiden von Kupfer- und Aluminiumkabeln



EN 60900

L mm	mm	€	Icon	Code
230	18	109,00	1	011320193

1142MQ

Abisolierzange



EN 60900

L mm	mm²	€	Icon	Code
160	0,5÷6	62,50	1	011420096

1150MQ

Universalzangen, verchromt, poliert



EN 60900

L mm	L1 mm	mm	€	Icon	Code
160	37	1,6	54,00	1	011500496
180	39	1,8	59,00	1	011500498
200	43	2,0	62,00	1	011500500
220	46	2,0	68,00	1	011500502

1162MQ

Flachzangen mit geraden Backen, extralang



EN 60900

L mm	L1 mm	mm	€	Icon	Code
160	56	1,6	58,00	1	011620096
200	76	1,6	61,50	1	011620100

1164MQ

Flachzangen mit gebogenen Backen, extralang



L mm	L1 mm	mm	€	Icon	Code
160	54	1,6	60,50	1	011640096
200	76	1,6	63,50	1	011640100

1166MQ

Zangen mit halbrunden Backen, extralang, gerade



EN 60900

L mm	L1 mm	mm	€	Icon	Code
160	56	1,6	58,00	1	011660096
200	76	1,6	61,50	1	011660100

1168MQ

Zangen mit halbrunden Backen, extralang, gebogen



EN 60900

L mm	L1 mm	mm	€	U	1000V
160	50	1,6	60,50	1	011680096
200	70	1,6	63,50	1	011680100

1169MQ/D2

Sortiment, 1000V-isoliert, aus 1 Universalzange und 1 Schneidzange



1000 V

1169MQ/D2	€	U	1000V
1150MQ 180 mm	118,00	1	011690152
1082MQ 160 mm			

1272MQF

Schraubendreher für Phillips®-Schrauben

Slim

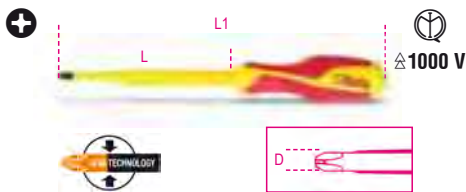

EN60900

PHxDxL mm	L1 mm	€	U	1000V
1x4,5x80	187	17,00	3	012720609
2x6x100	218	19,20	3	012720618

1272MQ

Schraubendreher für Phillips®-Schrauben

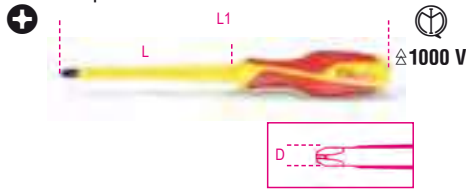

EN 60900

PHxDxL mm	L1 mm	€	U	1000V
0x3x60	160	11,50	3	012720703
1x4,5x80	187	14,00	3	012720709
2x6x100	218	16,00	3	012720718
3x8x150	276	20,70	2	012720724
4x10x200	326	24,60	2	012720727



1272MQ/S5	€	U	1000V
PH0x3x60-PH1x4,5x80 PH2x6x100-PH3x8x150 PH4x10x200 mm	86,50	1	012720751

1273MQF/D...

Slim-Schraubendrehersatz, 6-teilig



1273MQF/D4	€	U	1000V
1272MQF 1x4,5x80-2x6x100 mm 1274MQF 0,6x3,5x100-1x5,5x125 mm	67,50	1	012730604

1273MQF/D6	€	U	1000V
1272MQF 1x4,5x80-2x6x100 mm 1274MQF 0,6x3,5x100-1x4,5x100 1x5,5x125-1,2x6,5x150 mm	105,00	1	012730606

1273MQ/D6

Schraubendrehersatz, 6teilig



1273MQ/D6	€	U	1000V
1274MQ 0,5x3x100 -0,8x4x100 1,0x5,5x125 mm 1272MQ PH0x3x60 -PH1x4,5x80 PH2x6x100 mm	81,50	1	012730851

1274MQF

Schraubendreher für Gewindestifte mit Schlitz

Slim



EN60900

SxDxL mm	L1 mm	€	U	1000V
0,6x3,5x100	200	14,60	3	012740603
1x4,5x100	205	16,20	3	012740606
1x5,5x125	232	17,10	3	012740609
1,2x6,5x150	268	20,50	3	012740612

1274MQ

Schraubendreher für Gewindestifte mit Schlitz

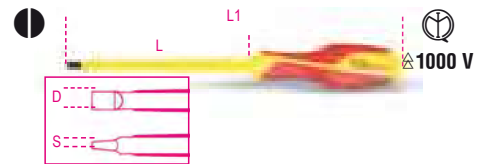

EN 60900

SxDxL mm	L1 mm	€	U	1000V
0,4x2,5x75	175	11,20	3	012740700
0,5x3x100	200	11,70	3	012740703
0,8x4x100	207	13,80	3	012740706
1x5,5x125	232	14,70	3	012740709
1,2x6,5x150	268	17,80	3	012740712
1,2x8x175	301	20,70	2	012740715
1,6x10x200	326	24,50	2	012740718



1274MQ/S6	€	U	1000V
0,5x3x100-0,8x4x100 1x5,5x125-1,2x6,5x150 1,2x8x175-1,6x10x200 mm	103,50	1	012740751

1275MQ/C

Schraubendreher für Kreuzschlitzschrauben PH

Slim

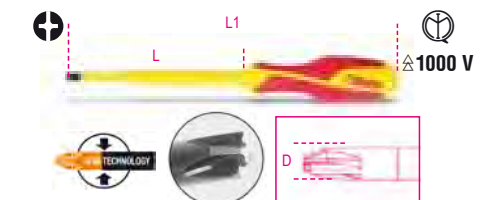

EN60900

PH1+LPP	€	U	1000V
PH1+LPP	15,70	2	012750409
PH2+LPP	17,80	2	012750418

1276MQ/C

Schraubendreher für Kreuzschlitzschrauben
PZ

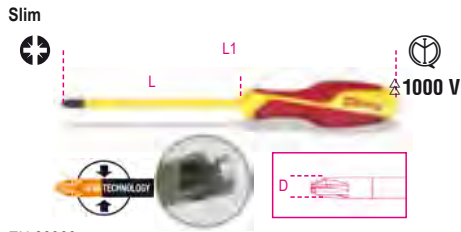

EN 60900

☉ PZ1+LPP	€ 14,80	2	012760409
☉ PZ2+LPP	€ 16,70	2	012760418

1279MQ/F

Schraubendreher für
Pozidriv®- und Supadriv®-Schrauben



EN60900

pz	L mm	L1 mm	€	Stk	Art-Nr
1	80	187	15,70	3	012790409
2	100	218	17,80	3	012790418

1279MQ

Schraubendreher
für Pozidriv®- und Supadriv®-Schrauben



EN 60900

PZ	L mm	L1 mm	€	Stk	Art-Nr
0	60	160	11,80	3	012790703
1	80	187	14,20	3	012790709
2	100	218	16,40	3	012790718
3	150	276	21,60	2	012790724



1279MQ/S4 PZ 0-1-2-3	€ 64,00	1	012790751
-------------------------	---------	---	-----------

1725MQ

Kleinstsägebogen



EN 60900

1725MQ	L mm 260	H mm 85	€ 109,00	1	017250030
--------	----------	---------	----------	---	-----------

1777MQ/C

Abisoliermesser

• für Mehrpolkabel



EN 60900

1777MQ/C	L mm 190	€ 44,00	1	017770026
----------	----------	---------	---	-----------

1777MQ/U

Abisoliermesser



EN 60900

1777MQ/U	L mm 190	€ 39,50	1	017770011
----------	----------	---------	---	-----------

1777RL/U

4 Ersatzklinge für Cutter Art. 1777MQ/U



1777RL/U	€ 32,00	1	017770021
----------	---------	---	-----------

1995MQ/T

Isoliermatte

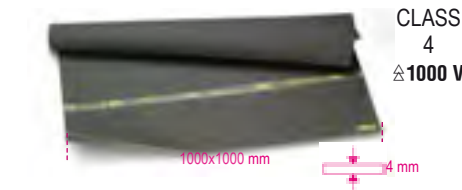

VDE 0303
EN 60243

1995MQ/T	LxSxH mm 1000x1000	€ 362,00	1	019950030
----------	--------------------	----------	---	-----------

1995MQ/G1 - G2

Isolierhandschuhe aus Latex



EN 60903

	Gr.	L mm	€	Stk	Art-Nr
1995MQ/G1	9	410	145,00	1	019950010
1995MQ/G2	10	410	145,00	1	019950013

1996MQ/T

Isoliertuch

500x500mm

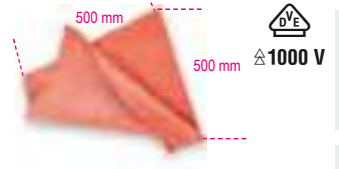

DIN EN 61112

1996MQ/T0,5	S mm 1.0	€ 111,00	1	019960005
-------------	----------	----------	---	-----------

1996MQ/GM

Isolierhandschuhe aus Verbundmaterial

EN60903
EN388



EN 60903
EN 61482

	Gr.	L mm	€	Stk	Art-Nr
1996MQ/GM 9	9	410	186,00	1	019960109
1996MQ/GM 10	10	410	186,00	1	019960110

1996SVG

Pneumatischer Isolierhandschuhprüfer

obligatorisch für EN90603



1996SVG	€ 425,00	1	019960133
---------	----------	---	-----------

2115P L-MQ32



2115PL-MQ32	362
-------------	-----

2029EM



2029EM	355
--------	-----

5989 VEM



5989 VEM	517
----------	-----



WERKZEUG- RÜCKHALTESYSTEM

Beta H-SAFE

Das Werkzeugangebot H-SAFE von Beta umfasst mehr als 200 Referenzen bzw. Artikel, für die individuell ein Rückhaltesystem entwickelt wurde, um die stärksten mechanischen Belastungen standzuhalten, und somit maximale Sicherheit zu garantieren.

Auch der Gebrauchskomfort ist wichtig, so sind die Werkzeuge mit doppeltem aktivem Teil, wie zum Beispiel der Ring-Maulschlüssel Art. 42, mit einem Kabel angeschnallt.

Das verläuft entlang dem ganzen Werkzeugkörpers, während die Drehwerkzeuge, wie der Schraubendreher, mit frei drehendem Ring angeschnallt sind, damit sich das Kabel nicht verwickeln kann.



Das Sicherheitssystem H-SAFE wurde in den BETA-Werken entwickelt, getestet und hergestellt. Mit dem Sicherheitssystem H-SAFE von BETA sind die Werkzeuge immer auf komfortable und sichere Art und Weise griffbereit.



35HS

Flachmeißel, mit Hohlprofil H-SAFE





L mm	A mm	€		
200	23,0	47,00	1	000354004
250	28,5	59,00	1	000354005

42HS

Ring-Maulschlüssel H-SAFE



DIN 3113 UNI-ISO 7738

 mm	L mm	€		
6x6	95	24,20	1	000424506
7x7	105	24,60	1	000424507
8x8	116	24,80	1	000424508
9x9	127	25,50	1	000424509
10x10	137	25,50	1	000424510
11x11	148	26,00	1	000424511
12x12	158	26,50	1	000424512
13x13	169	27,00	1	000424513
14x14	180	28,50	1	000424514
15x15	190	28,50	1	000424515
16x16	201	29,00	1	000424516
17x17	212	30,50	1	000424517
18x18	222	31,50	1	000424518
19x19	233	32,50	1	000424519
20x20	243	33,00	1	000424520
21x21	254	35,00	1	000424521
22x22	264	36,00	1	000424522
23x23	275	38,00	1	000424523
24x24	285	39,50	1	000424524
25x25	296	39,50	1	000424525
26x26	307	40,50	1	000424526
27x27	317	44,00	1	000424527
28x28	328	44,50	1	000424528
29x29	338	48,00	1	000424529
30x30	349	50,00	1	000424530
32x32	370	55,50	1	000424532
34x34	391	91,50	1	000424534
36x36	412	101,00	1	000424536

42HS/AS

Ring-Maulschlüssel H-SAFE



 mm	L mm	€		
1/4x1/4	95	26,00	1	000424106
5/16x5/16	116	26,00	1	000424108
3/8x3/8	137	27,50	1	000424110
7/16x7/16	148	28,50	1	000424111
1/2x1/2	169	28,00	1	000424113
9/16x9/16	180	28,50	1	000424114
5/8x5/8	201	31,50	1	000424116
11/16x11/16	212	33,00	1	000424117

Ø	L mm	€	Hand	Computer
3/4x3/4	233	35,00	1	000424119
13/16x13/16	254	39,00	1	000424121
7/8x7/8	264	39,50	1	000424122
15/16x15/16	285	44,00	1	000424124
1x1	296	45,00	1	000424125
1.1/16x1.1/16	317	49,00	1	000424127
1.1/8x1.1/8	338	52,00	1	000424129
1.1/4x1.1/4	370	62,00	1	000424132
1.5/16x1.5/16	391	93,50	1	000424133

55HS

Doppelmaulschlüssel H-SAFE



UNI-ISO 10102 DIN 3110

Ø mm	L mm	€	Hand	Computer
• 6x7	120	19,40	1	000554012
• 8x9	140	19,80	1	000554021
• 10x11	155	20,10	1	000554030
• 12x13	170	22,00	1	000554042
• 14x15	185	22,60	1	000554054
• 16x17	202	23,90	1	000554060
• 18x19	220	25,50	1	000554066
• 20x22	236	26,50	1	000554075
• 21x23	245	28,50	1	000554078
• 22x24	245	30,00	1	000554081
• 24x27	262	33,00	1	000554090
• 30x32	297	41,50	1	000554108
• 34x36	325	92,50	1	000554117

91HS-C

Aufsteckringschlüssel H-SAFE



Ø mm	Ø mm	€	Hand	Computer
36	54	113,50	1	000914036
41	62	133,00	1	000914041
46	69	154,00	1	000914046

91HS

Aufsteckringschlüssel H-SAFE



Ø mm	Ø mm	€	Hand	Computer
36	54	227,00	1	000914236
41	62	246,00	1	000914241
46	69	290,00	1	000914246

92HS

Aufsteckrohre für Art. 91 H-SAFE



L mm	91 mm	Ø mm	€	Hand	Computer
610	32+41	22	113,00	1	000924020
760	46+55	25	136,00	1	000924030

93HS

Doppelringschlüssel, flach geköpft, speziell für Gerüste H-SAFE



Ø mm	L mm	€	Hand	Computer
21x22	310	65,50	1	000934021

96TBP-HS

Sechskant-Stiftschlüssel, gebogen, mit kugelförmigem Kopf und Griff mit Anti-Kipp-System H-SAFE

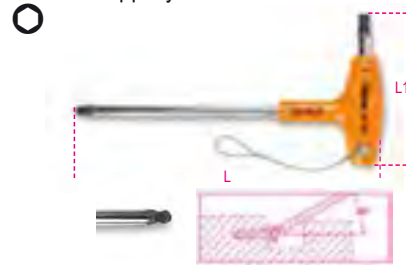

Ø mm	L mm	L1 mm	Ø mm	€	Hand	Computer
2,5	153	55	4	30,50	1	000964685
3	153	55	4	32,00	1	000964686
4	179	70	5	32,50	1	000964687
5	200	84	6	33,00	1	000964688
6	221	103	7	35,50	1	000964689
8	255	117	10	41,50	1	000964690
10	285	132	12	45,00	1	000964692

96THS

Sechskant-Stiftschlüssel mit Griff H-SAFE

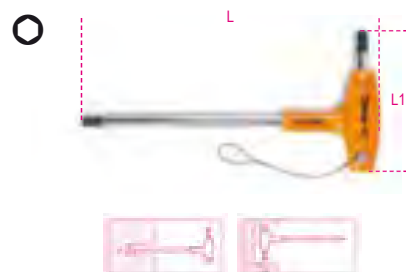

mm	L mm	L1 mm	€	Hand	Computer
2,5	153	55	29,50	1	000964935
3	153	55	30,00	1	000964936
4	179	70	30,50	1	000964938
5	200	84	31,50	1	000964940
6	221	103	33,50	1	000964941
8	255	117	39,50	1	000964943
10	285	132	43,50	1	000964945

96THS-AS

Sechskant-Stiftschlüssel mit Griff H-SAFE



Ø	L mm	L1 mm	Ø mm	€	Hand	Computer
5/32	200	84	6	33,50	1	000964673
3/16	200	84	6	33,50	1	000964674
7/32	221	103	7	37,50	1	000964675
1/4	236	106	8	38,50	1	000964676
5/16	255	117	10	41,50	1	000964678
3/8	285	132	12	45,50	1	000964680

97TTXHS

Stiftschlüssel mit Griff, für Torx®-Schrauben H-SAFE



Ø	L mm	L1 mm	€	Hand	Computer
T10	179	70	30,00	1	000974710
T15	179	70	30,50	1	000974715
T20	179	70	31,50	1	000974720
T25	179	70	32,00	1	000974725
T30	200	84	37,00	1	000974730
T40	221	103	39,00	1	000974740
T45	236	106	42,00	1	000974745
T50	255	117	51,50	1	000974750

111E-HS

Einmaulschlüssel, verstellbar, mit Messskala, verchromt

Mit Anti-Kipp-System H-SAFE

- Rechtsdrehung der Rolle
- Messskala in mm/Zoll

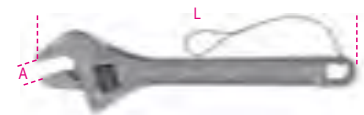

DIN 3117 ISO 6787

L mm	L "	A max mm	€	Hand	Computer
200	8	29	60,50	1	001114120
250	10	34	68,50	1	001114125
300	12	40	84,50	1	001114130
380	15	45	144,00	1	001114138
450	18	54	228,00	1	001114145

142HS

Ring-Maulschlüssel mit Umschaltknarre

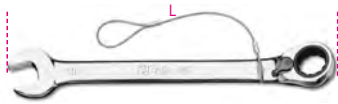

Ø mm	L mm	€	Icon	Icon	Code
8x8	136	38,00	1	001424008	
9x9	143	39,00	1	001424009	
10x10	159	39,50	1	001424010	
11x11	168	40,00	1	001424011	
12x12	174	40,50	1	001424012	
13x13	180	42,00	1	001424013	
14x14	190	43,50	1	001424014	
15x15	200	45,00	1	001424015	
16x16	216	48,00	1	001424016	
17x17	233	49,00	1	001424017	
18x18	239	52,00	1	001424018	
19x19	248	52,50	1	001424019	
21x21	285	63,00	1	001424021	
22x22	285	64,00	1	001424022	
24x24	325	74,00	1	001424024	
27x27	355	98,50	1	001424027	
30x30	420	114,00	1	001424030	
* 32x32	420	119,00	1	001424032	

360HS

Rohrzangen, Modell "Stillson" H-SAFE



L mm	Ø max " "	€	Icon	Icon	Code
250	1" gas	61,50	1	003604025	
350	1 1/2" gas	76,00	1	003604035	
450	2" gas	98,00	1	003604045	
600	2 1/2" gas	140,50	1	003604060	



LC system, Doppelkugel-Rückhaltesystem, die Freigabe des Steckschlüsselserfolgt nur durch Tastendruck

666HS

Drehmomentschlüssel mit Signalgebung ZERO-RESET mit Umschaltknarre für rechtsgängigen Anzug Anzugsgenauigkeit: ±3%

mit Anti-Kipp-System H-SAFE

• Bedarf keiner Rückstellung



ISO 6789

Nm	Icon	D mm	A mm	L mm	LC system	g	Icon
10÷50	3/8	30	33	342	-	680	0,25

€	Icon	Icon	Code
314,00	1	006664705	

Nm	Icon	D mm	A mm	L mm	LC system	g	Icon
20÷100	3/8	30	33	385	-	760	0,25

€	Icon	Icon	Code
319,00	1	006664710	

Nm	Icon	D mm	A mm	L mm	LC system	g	Icon
40÷200	1/2	42	43	471	*	1020	0,5

€	Icon	Icon	Code
359,00	1	006664721	

Nm	Icon	D mm	A mm	L mm	LC system	g	Icon
60÷300	1/2	42	43	600	*	1270	1,0

€	Icon	Icon	Code
403,00	1	006664731	

900E-HS/55

Umschaltknarre H-SAFE



DIN 3122 - UNI-ISO 3315

L mm	Ø mm	A mm	Icon	€	Icon	Icon	Code
125	25	18	1/4	59,00	1	009004880	

910E-HS/55

Umschaltknarre H-SAFE



DIN 3122 - UNI-ISO 3315

L mm	Ø mm	A mm	Icon	€	Icon	Icon	Code
200	30	33	3/8	65,50	1	009104880	

920E-HS/55LC

Umschaltknarre H-SAFE mit Locking System



DIN 3122 - UNI-ISO 3315

L mm	Ø mm	A mm	Icon	€	Icon	Icon	Code
275	40	43	1/2	97,00	1	009204860	

932HS

Doppelsteckschlüssel, 12kant x 6kant, verchromt, poliert H-SAFE

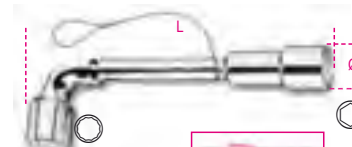

NF E 74.303

Icon	Ø mm	L mm	€	Icon	Icon	Code
6x6	11,5	110	32,00	1	009324006	
7x7	12,5	116	33,00	1	009324007	
8x8	13,0	120	35,00	1	009324008	
9x9	14,0	125	35,50	1	009324009	
10x10	16,5	133	37,00	1	009324010	
11x11	17,5	143	38,50	1	009324011	
12x12	19,0	148	39,50	1	009324012	
13x13	19,5	154	40,00	1	009324013	
14x14	21,5	167	43,50	1	009324014	
15x15	22,5	182	44,00	1	009324015	
16x16	24,5	193	45,00	1	009324016	
17x17	26,0	198	45,50	1	009324017	
18x18	26,5	215	49,00	1	009324018	
19x19	29,0	220	52,00	1	009324019	

1032HS

Zangen mit geraden Backen, für Sicherungsrings mit Innenspannung, Griffe mit PVC-Überzug



UNI 7914 DIN 5256

L mm	Ø mm	Ø1 mm	A mm	€	Icon	Icon	Code
140x1,3	12÷25	1,3	20	44,50	1	010324014	
180	19÷60	1,9	21	47,00	1	010324017	

1034HS

Zangen mit um 90° gebogenen Backen, für Sicherungsringe mit Innenspannung, Griffe mit PVC-Überzug



UNI 7914 DIN 5256

L	∅	∅1	A	€	📦	📄
mm	mm	mm	mm			
170	19÷60	1,9	21	49,50	1	010344017

1036HS

Zangen mit geraden Backen, für Sicherungsringe mit Außenspannung, Griffe mit PVC-Überzug



UNI 7915 DIN 5254

L	∅	∅1	A	€	📦	📄
mm	mm	mm	mm			
140x1,3	10÷25	1,3	20	47,00	1	010364014
175	19÷60	1,9	21	48,00	1	010364017

1038HS

Zangen mit um 90° gebogenen Backen, für Sicherungsringe mit Außenspannung, Griffe mit PVC-Überzug



UNI 7915 DIN 5254

L	∅	∅1	A	€	📦	📄
mm	mm	mm	mm			
175	19÷60	-	21	51,50	1	010384017

1048BM-HS

Verstellbare Zangen, durchgestecktes Gelenk, Bimaterial-Griffe

• Neues Modell mit neun Positionen

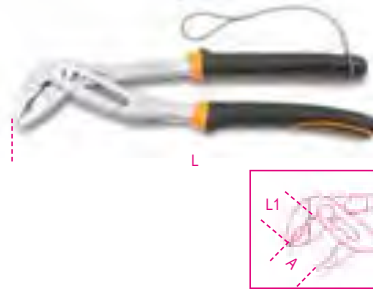

ISO 8976

L	A max	L1	g	€	📦	📄
mm	mm	mm	g			
250	48	39	460	73,50	1	010484215

1052HS

Grifzangen, verstellbar, konkave Backen

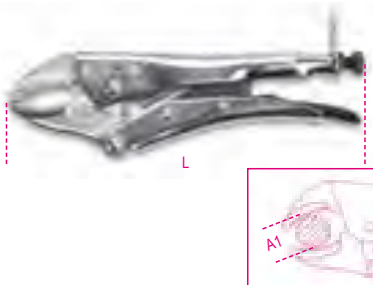

L	A	A1 max	S	€	📦	📄
mm	mm	mm	mm			
240	72	42	10,0	60,50	1	010524024

1082BM-HS

Diagonalseitenschneider, Griffe aus Bimaterial



UNI/ISO 5749

L	L1	∅	A	€	📦	📄
mm	mm	mm	mm			
160	22	1,6	28,0	59,50	1	010824036

1088BM-HS

Vornschnieder für geringen Kraftaufwand, Griffe aus Bimaterial

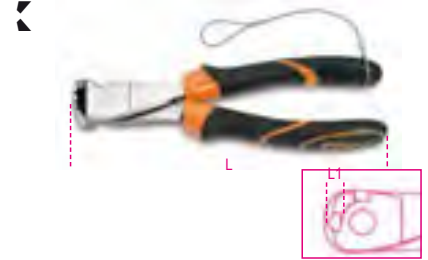

UNI/ISO 5748

L	L1	∅	A	€	📦	📄
mm	mm	mm	mm			
160	9	1,6	28,0	68,50	1	010884036
200	11	2,0	36,0	86,00	1	010884040

1128BAX-HS

Doppeltwirkende Elektrikerschere, mit Fräsenprofil aus rostfreiem Stahl mit DLC-Beschichtung H-SAFE

Doppeltwirkender Schnitt: Durch eine besondere Nocke auf dem Scharnier ist ein Längslauf der Messer möglich, der beim Schließen, die Schneidkraft der Schere erhöht.

Fräsenprofil: Zum Weiten der Löcher auf Kunststoff von 13 bis 25 mm.

DLC Beschichtung: DLC (diamond-like carbon) ist eine innovative kohlenstoffbasierte Beschichtung: Die hohe Härte und der niedrige Reibkoeffizient entstehen durch das gleichzeitige Vorhandensein von Carbon, das in Form von Graphit gelagert ist, und einem diamantähnlichen Kohlenstoff.

- Hohe Oberflächenhärte der Messer (Abriebfestigkeit und Beibehaltung des Schliffs auf Dauer)
- Niedriger Reibkoeffizient (gleitender und kräftiger Schnitt)
- Antilockerungs-Exzenterstift
- Weite Griffe mit Rohrverengungskehlen
- Geliefert mit Kunststoffetui



L	L1	∅	€	📦	📄
mm	mm	mm ²			
150	50	50	57,00	1	011284088



1132BM-HS

Kabelschneider, Griffe aus Bimaterial, für isolierte Kupfer- und Aluminiumkabel H-SAFE



UNI 8791

L	mm	A	B	€	U	U
230	18	37	12,5	105,00	1	011324143

1150BM-HS

Universalzangen, verchromt, poliert, Griffe aus Bimaterial H-SAFE



ISO 5746

L	L1	mm	A	€	U	U
160	42	1,6	22,0	52,00	1	011504146
180	46	1,8	25,0	54,00	1	011504148
200	50	2,0	27,0	59,50	1	011504150

1166BM-HS

Zangen mit halbrunden Backen, extralang, gerade, innengeriffelt, Griffe aus Bimaterial H-SAFE



ISO 5745

L	L1	mm	A	€	U	U
200	76	1,6	22,0	61,50	1	011664040

1168BM-HS

Zangen mit halbrunden Backen, extralang, gebogen, innengeriffelt, Griffe aus Bimaterial



ISO 5745

L	L1	mm	A	€	U	U
200	70	1,6	22,0	64,50	1	011684040

1290HS

Schraubendreher für Schlitzschrauben H-SAFE

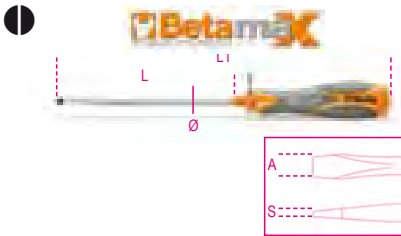

ISO 2380

SxAxL	L1	Ø	€	U	U
0,4x2,5x75	171	2,5	21,40	1	012904006
0,5x3x100	196	3,0	22,20	1	012904012
0,6x3,5x100	196	3,5	23,60	1	012904021
0,8x4x100	196	4,0	23,10	1	012904030
0,8x4x150	246	4,0	24,70	1	012904036
1x5,5x150	259	5,0	27,50	1	012904042
1,2x6,5x150	270	6,0	29,00	1	012904051
1,2x8x150	282	7,0	32,50	1	012904057
1,6x10x200	332	8,0	38,00	1	012904066

1292HS

Schraubendreher für Phillips®-Schrauben H-SAFE

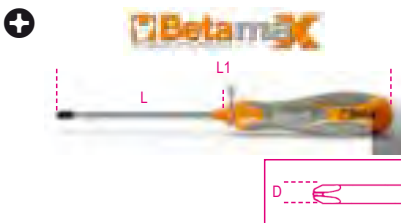

UNI/ISO 8764

PHxDxL	L1	€	U	U
0x3x100	196	22,40	1	012924006
1x4,5x120	229	24,80	1	012924012
2x6x150	270	29,50	1	012924021
3x8x150	282	34,00	1	012924024

1294HS

Schraubendreher für Gewindestifte mit Schlitz H-SAFE

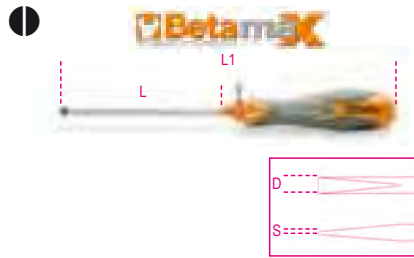

SxDxL	L1	€	U	U
0,5x2,5x60	156	20,90	1	012944003
0,6x3x75	171	21,10	1	012944006
0,8x4x100	196	23,20	1	012944012
1x5x125	234	27,00	1	012944018

1299HS

Schraubendreher für Pozidriv® und Supadriv®-Schrauben H-SAFE



UNI/ISO 8764

PZ	L	L1	€	U	U
0	60	156	23,50	1	012994000
1	80	189	26,00	1	012994003
2	100	220	32,50	1	012994006
3	150	282	40,00	1	012994009

1370T-HS

Schlosserhammer, deutsches Modell, Stiel aus Fasern H-SAFE



g	A	L	L1	€	U	U
300	23	300	105	44,50	1	013704630
500	27	320	118	47,50	1	013704650
1000	36	360	135	59,50	1	013704700



1370FT-HS

Schlosserhämmer, französisches Modell, Stiel aus Fasern



A mm	L mm	L1 mm	B mm	€	🛒	📄
28	280	86	22	60,50	1	013704528
30	280	92	24	61,50	1	013704530
36	300	104	29	72,50	1	013704536

1390HS

Hämmer mit auswechselbaren Kunststoffaufsätzen, Stiel aus Holz H-SAFE



UNI 7784

D mm	L mm	L1 mm	€	🛒	📄
35	310	95	56,00	1	013904035
45	320	107	79,00	1	013904045

1392HS

Rückschlagfreie Hämmer mit auswechselbaren Kunststoffaufsätzen, Stiel aus Stahl H-SAFE



D mm	L mm	L1 mm	€	🛒	📄
35	305	115	81,00	1	013924035
40	310	125	90,50	1	013924040
50	325	135	106,00	1	013924050
60	385	155	154,00	1	013924060

1602A-HS

Anpresszange für isolierte Kabelverbindungen, Standardmodell H-SAFE

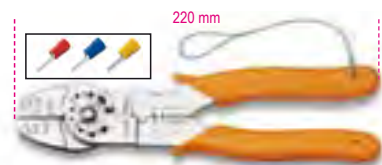

mm ²	L mm	A mm	B mm	€	🛒	📄
0÷6	220	42	4	86,00	1	016024005

1682HS

Flexible Maßstäbe, aus rostfreiem Stahl

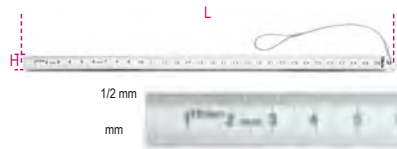

L mm	H mm	± mm	€	🛒	📄
200	13	0,5	19,40	1	016824020
300	13	0,5	22,00	1	016824030

1692HS

Rollbandmaße, schlagfestes ABS Gehäuse aus Bimaterial Stahlband
Präzisionsklasse: IIH-SAFE



L m	S mm	€	🛒	📄
3	16	26,00	1	016924053
5	19	30,50	1	016924055

1708HS/20

Fühlerlehren H-SAFE



S mm	S mm	L mm	€	🛒	📄
0,05±1,0	0,002±0,040	105	28,00	1	017084020

1727HS

Sägebogen, schwere Ausführung H-SAFE



L mm	L1 mm	€	🛒	📄
515	300	39,50	1	017274001

1743HS

Anpresszange für Nylonkabelbinder H-SAFE

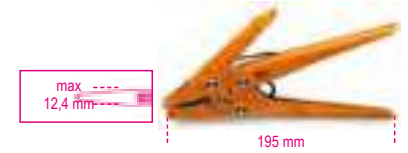

L mm	A mm	B mm	€	🛒	📄
195	85	17	82,00	1	017434001

1750HS

Hebelfettpressen H-SAFE



1 g, 550 bar Max

cc	L mm	€	🛒	📄
500	380	69,00	1	017504500

1760BHS

Mehrzweck-Digitalmultimeter H-SAFE



DURCHFÜHRBARE MESSUNGEN
Spannung DC: 200 mV-2/20/200/1000V
Spannung AC: 2-20/200/700V
Strom DC: 2/20/200 mA-20 A
Strom AC: 2/200 mA- 20 A
Widerstand: 200Ω - 2/20/200 kΩ - 2/20 MΩ
Kapazität: 2/20/200 nF - 2/200 μF
Temperatur: -20° + 1000°C/-4 °F ~ +2000°F
Frequenz: 20kHz
Stromversorgung: 1 9V-Batterie (mitgeliefert)

1760BHS	€	🛒	📄
	273,00	1	017604012

1772H-HS

Sicherheitsmesser mit einziehbarer Klinge, mit 2 Klingen geliefert H-SAFE



L mm	A mm	€	1	017724029
170	18	35,50	1	017724029

1778S0S-HS

Auto-Notfallmesser mit Glasbruchhammer- und Sicherheitsgurtschneiderfunktion, mit Etui H-SAFE



L mm	A mm	L1 mm	€	1	017784080
205	25	85	57,00	1	017784080

8871

Sicherheitsgürtel mit Doppelverschluss-Metallschnalle



	L cm min-max	€	1	
8871 70	70-100	162,00	1	088710070
8871 100	100-135	175,00	1	088710100

8872A

Feste Schleife

• Für Gürtel Art. 8871



	€	1	
8872A 50	28,50	1	088720050

8872AS

Schleife mit Klettöffnung

• Für Gürtel Art. 8871



	D mm	€	1	
8872AS 25	25	26,00	1	088720525

8873

Werkzeugbeutel mit selbstschließendem Verschluss und Reißverschluss

• Für Gürtel Art. 8871



	€	1	
8873 230	137,00	1	088730230

8877

Stoßgedämpfte Verbindungsschnur

• MAX 2.7 kg



	L cm min+max	DxL mm	€	1	
8877 80	70-110	40x80	35,00	1	088770080

8877M

Stoßgedämpfte Verbindungsschnur

• Mit verdrehgeschützter Kupplung • MAX 2.7 kg



	L cm min+max	DxL mm	€	1	
8877M 20-140	20-140	30x60	62,50	1	088770510

8879

Handgelenkmanschette

• MAX 2.7 kg



	D mm	€	1	
8879	30	40,00	1	088790025

8880

Starre Verbindungsschnur

• Mit verdrehgeschützter Kupplung



	L Cm	D mm	€	1	
8880 30	30	10	31,50	1	088800030

8883

Werkzeug-Sack

• Aus abriebfestem Nylon 840 • MAX 20 kg • Karabinerhaken zum Blockieren des Reißverschlusses am Endanschlag • 6 Werkzeug-Rückhalteschlingen • Mit Innentasche

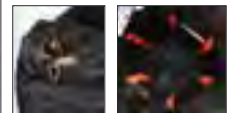

	DxH cm	€	1	
8883	30x40	331,00	1	088830030





WERKZEUGE AUS EDELSTAHL



Die Werkzeuge BETA INOX können bei speziellen Anwendungen verwendet werden, d.h. in Bereichen, in dem keine Korrosion zulässig ist. Nachstehend einige Beispiele:

- Nukleare Anwendungen
- Pharmazeutische Produktion
- Offshore-Anwendungen
- Biotechnologische und biomedizinische Laboratorien
- Lebensmittelindustrie.

Die Werkzeuge Beta Inox vermeiden die Bildung von Rost.

Bei nicht aus rostfreien Materialien gefertigten Werkzeugen können an Schrauben, Muttern oder Edelstahloberflächen sich Partikel von den Werkzeugen lösen, die Korrosionsprozesse herbeiführen und dadurch ästhetische Probleme, und in einigen Fällen, strukturelle Probleme verursachen.

Anwendungsbeispiele sind:

Werften,
Baugewerbe,
Solaranlagen,
Automobilindustrie.



INOX + NICHT INOX
= ROST



INOX + INOX
= KEIN ROST

EIGENSCHAFTEN

Die sorgfältige Wahl der Materialien¹, und die umfassende Erforschung der besten Wärmebehandlungen verleihen den Werkzeugen Beta Inox mechanische Eigenschaften, die um einiges die Normwerte der normalen Beta Werkzeugen mit vergleichbaren Eigenschaften übertreffen.

Die Ergonomie und das Design der Produkte, sind die gleichen, der seit mehr als 75 Jahren bekannten und von Anwendern geschätzten Beta Werkzeugen.

Der Edelstahl ist zu 100% wiederverwertbar, was ebenfalls eine wichtige Eigenschaft ist.



Zeichen für Edelstahl Rostfrei
Es handelt sich um ein vom Centro Inox
ausgestelltes Zeichen - Italienischer Verband
für die Studie und Entwicklung von Edelstahl-
Anwendungen, der die aus rostfreiem Stahl
hergestellten Produkte kennzeichnet

34INOX

Flachmeißel,
aus Edelstahl



L mm	A mm	Ø mm	€	U	PC
160	18	18	49,00	1	000340318
200	20	20	72,50	1	000340320

39INOX

Keile,
aus Edelstahl



L mm	A mm	S mm	€	U	PC
100	50	10	34,00	1	000390310
150	50	13	61,50	1	000390315
200	40	40	180,00	1	000390320

42INOX

Ring-Maulschlüssel
aus Edelstahl

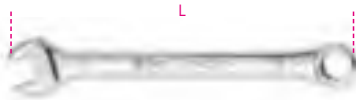

DIN 3113 - UNI ISO 7738

Ø mm	L mm	€	U	PC
6x6	95	17,10	2	000420306
7x7	105	17,80	2	000420307
8x8	116	17,90	2	000420308
9x9	127	19,30	2	000420309
10x10	137	20,30	2	000420310
11x11	148	22,00	2	000420311
12x12	158	22,90	2	000420312
13x13	169	23,10	2	000420313
14x14	180	24,00	2	000420314
15x15	190	24,70	2	000420315
16x16	201	25,50	2	000420316
17x17	212	28,50	2	000420317
18x18	222	30,50	2	000420318
19x19	233	33,00	2	000420319
21x21	254	40,00	1	000420321
22x22	264	41,50	1	000420322
24x24	285	45,50	1	000420324
27x27	290	133,00	1	000420327
30x30	320	162,50	1	000420330
32x32	340	176,50	1	000420332
36x36	360	248,00	1	000420336
38x38	430	265,00	1	000420338
41x41	430	311,00	1	000420341
46x46	480	357,00	1	000420343
50x50	520	384,00	1	000420345
55x55	560	416,00	1	000420347
60x60	595	462,00	1	000420350



€	U	PC
259,00	1	000420391

42INOX/S11
6-8-10-11-12-13-
14-15-16-17-19 mm



€	U	PC
226,00	1	000420387
11,90	1	000420303

42INOX/SC9
8-10-11-12-13-14-15-17-19 mm
42INOX/SCV9

42INOX-AS

Ringmaulschlüssel,
aus Edelstahl



Ø	L mm	€	U	PC
1/4x1/4	95	20,60	1	000420356
5/16x5/16	116	20,80	1	000420358
3/8x3/8	137	24,90	1	000420360
7/16x7/16	148	27,00	1	000420361
1/2x1/2	169	27,50	1	000420363
9/16x9/16	180	29,50	1	000420364
5/8x5/8	201	31,50	1	000420366
11/16x11/16	212	36,50	1	000420367
3/4x3/4	233	39,50	1	000420369
13/16x13/16	254	45,50	1	000420371
7/8x7/8	264	48,00	1	000420372
15/16x15/16	285	54,00	1	000420373



€	U	PC
258,00	1	000420396

42INOX-AS/S9
1/4-5/16-3/8-7/16-1/2
9/16-5/8-11/16-3/4



96BPINOX

Sechskant-Stiftschlüsselsatz, gebogen, mit
kugelförmigem Kopf,
aus Edelstahl



mm	L mm	L1 mm	g	€	U	PC
2	91	22	4	6,10	4	000961441
2,5	91	22	6	6,10	4	000961442
3	101	24	11	6,50	4	000961443
4	112	29	19	7,20	4	000961444
5	131	33	32	8,60	4	000961445
6	154	36	51	9,50	4	000961446
7	164	40	65	12,30	2	000961447
8	175	44	116	14,90	2	000961448
10	197	51	189	18,50	2	000961450



€	U	PC
59,50	1	000961455
96,00	1	000961456
7,40	1	000961459

96BPINOX/B6
2,5-3-4-5-6-8 mm
96BPINOX/B9
2-2,5-3-4-5-
6-7-8-10 mm
96BPINOX/BV

96BPINOX-AS

Sechskant-Stiftschlüssel, gebogen, mit
kugelförmigem Kopf,
aus Edelstahl

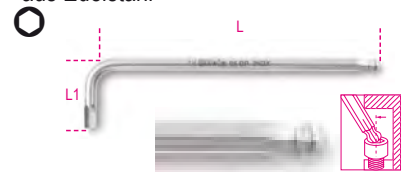

mm	L mm	L1 mm	g	€	U	PC
5/64	91	22	5,5	7,90	4	000961989
3/32	91	22	5,3	7,90	4	000961990
7/64	101	24	10,5	8,40	4	000961991
1/8	101	24	10,7	8,40	4	000961992
9/64	112	29	18,7	9,30	4	000961993
5/32	112	29	18,7	9,30	4	000961994
3/16	131	33	31,5	12,30	2	000961995
7/32	154	36	50,0	12,70	2	000961996
1/4	164	40	70,0	13,40	2	000961997
5/16	175	44	115,0	15,90	2	000961998
3/8	197	51	186,5	19,70	2	000961999



€	U	PC
94,50	1	000962000
7,40	1	000961459

96BPINOX-AS/B8
5/64-3/32-1/8-5/32-
3/16-7/32-1/4-5/16
96BPINOX/BV

96TINOX

Sechskant-Stiftschlüssel mit Griff,
aus Edelstahl



mm	L mm	L1 mm	€	🔧	📄
2,5	153	55	14,50	2	000961935
3	153	55	15,10	2	000961936
4	179	70	16,60	2	000961938
5	200	84	18,40	2	000961940
6	221	95	20,00	2	000961941
7	236	106	23,00	2	000961942
8	255	117	27,50	2	000961943
10	285	132	35,00	2	000961944



96TINOX/S5 2,5-3-4-5-6 mm	€ 84,00	🔧 1	📄 000961952
96TINOX/S8 2,5-3-4-5-6-7-8-10 mm	€ 170,00	🔧 1	📄 000961954

96TINOX-AS

Sechskant-Stiftschlüssel mit Griff,
aus Edelstahl



"	L mm	L1 mm	Ø mm	€	🔧	📄
3/32	153	55	3	15,90	2	000961861
7/64	153	55	4	16,20	2	000961862
1/8	179	70	4	18,20	2	000961863
9/64	179	70	5	18,60	2	000961864
5/32	200	84	6	19,60	2	000961865
3/16	200	84	6	21,00	2	000961866
7/32	221	103	7	24,50	2	000961867
1/4	236	106	8	25,50	2	000961868
5/16	255	117	10	31,50	2	000961869
3/8	285	132	12	34,00	2	000961870



96TINOX-AS/S7 3/32-1/8-5/32-3/16-7/32-1/4-5/16	€ 157,00	🔧 1	📄 000961877
---	----------	-----	-------------

111INOX

Einmaulschlüssel,
aus Edelstahl



DIN 3117 - ISO 6787

L mm	L mm	A max mm	A1 mm	€	🔧	📄
150	6	18	45	105,50	1	001110315
200	8	24	58	137,00	1	001110320
250	10	30	70	170,00	1	001110325

362INOX

Rohrzangen, amerikanisches Modell,
aus Edelstahl



L mm	Ø max mm	€	🔧	📄
300	58	230,00	1	003620430

920INOX-A

Sechskant-Steckschlüssel
aus Edelstahl

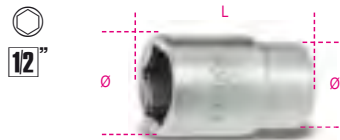

DIN 3124 - UNI ISO 2725

Ø mm	Ø mm	A mm	L mm	€	🔧	📄
8	15	10	40	36,50	2	009203008
9	16	10	40	38,50	2	009203009
10	17	10	40	40,00	2	009203010
11	18	11	40	43,00	2	009203011
12	19	11	40	45,50	2	009203012
13	20	11	40	48,50	2	009203013
14	21	11	40	51,00	2	009203014
15	23	11	40	53,50	2	009203015
16	24	11	40	56,00	2	009203016
17	25	11	40	57,50	2	009203017
18	26	13	42	59,50	2	009203018
19	28	13	42	62,00	2	009203019
20	29	13	42	66,00	1	009203020
21	30	13	43	67,00	1	009203021
22	31	15	43	67,50	1	009203022
24	34	15	43	78,50	1	009203024
27	38	18	46	96,50	1	009203027
30	42	20	46	115,00	1	009203030
32	44	20	46	130,00	1	009203032



920/55INOX

Umschaltknarre
mit Außenvierkanttrieb 1/2",
72-zahng,
aus Edelstahl



L mm	Ø mm	A mm	€	🔧	📄
264	40	43	279,00	1	009203882

920/R55INOX



920/R55 INOX	€ 99,00	🔧 1	📄 009203879
--------------	---------	-----	-------------

1048INOX

Verstellbare Zange, durchgestecktes Gelenk,
aus Edelstahl

• Modell mit sieben Positionen

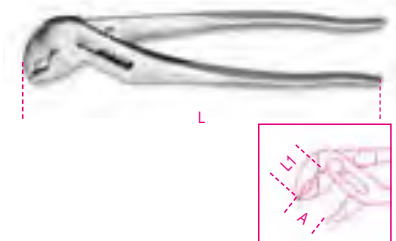

L mm	A max mm	L1 mm	€	🔧	📄
250	33	33	178,00	1	010480325

1082INOX

Diagonalseitenschneider
aus Edelstahl



L mm	L1 mm	mm	€	🔧	📄
150	20,0	1,6	130,00	1	010820350

1150INOX

Universal-Kraftzange aus Edelstahl

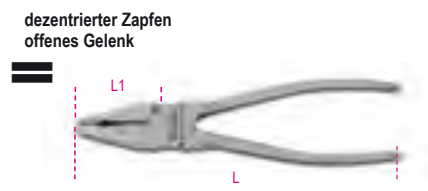

L mm	L1 mm	€	🔧	📄
180	39	126,00	1	011500518

1153INOX

Zange, 2fach verstellbar,
aus Edelstahl



L mm	L1 mm	€	🔧	📦
150	26	123,00	1	011530315

1290INOX

Schraubendreher für Schlitzschrauben,
aus Edelstahl

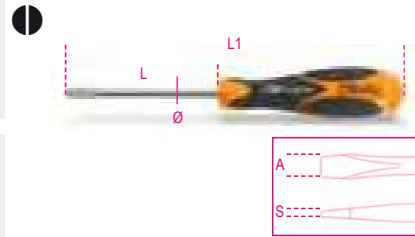

ISO 2380

SxAL mm	L1 mm	Ø mm	€	🔧	📦
0,4x2,5x50	146	2.5	10,70	4	012900403
0,5x3x75	171	3.0	10,90	4	012900409
0,8x4x100	196	4.0	11,40	4	012900430
1,0x5,5x150	259	5.0	14,40	4	012900442
1,2x6,5x150	270	6.0	16,60	4	012900451

1292INOX

Schraubendreher für Phillips®-Schrauben,
aus Edelstahl

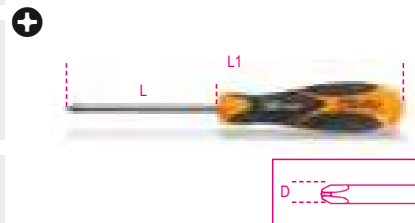

ISO 8764

PHxDxL mm	L1 mm	€	🔧	📦
0x3x60	156	10,00	4	012920403
1x4,5x80	189	11,80	4	012920409
2x6x100	220	14,40	4	012920418

1293INOX/D8

Schraubendrehersatz,
aus Edelstahl



1293INOX/D8	€	🔧	📦
1290INOX 0,4x2,5x50-0,5x3x75 0,8x4x100-1,0x5,5x150 1,2x6,5x150 mm	101,00	1	012930408
1292INOX PH0x60-PH1x80 PH2x100 mm			

1370INOX

Schlosserhammer,
deutsches Modell,
aus Edelstahl



g	A mm	L mm	L1 mm	€	🔧	📦
500	25	240	101	112,00	1	013700375

1377INOX

Hämmer für Blechbearbeitung,
amerikanisches Modell mit rundem Kopf und
kugelförmiger Pinne, aus Edelstahl



g	L mm	L1 mm	€	🔧	📦
230	220	82	64,50	1	013770623
340	220	90	93,00	1	013770634

1730INOX

Universalschaber,
aus Edelstahl



A mm	L mm	€	🔧	📦
50	200	57,00	1	017300450

C20TSS

Werkzeugkasten, ausklappbar, mit fünf
Fächern, aus Edelstahl AISI 304



C20TSS	€	🔧	📦
	346,00	1	021203001

📏: 450x200x210 mm - 🏠 4kg

T23



T23	549
TV23	549

T99



T99	552
TV99	552

T228



T228	556
TV180	555-556

Beta

Beta

C04TSS-7

Werkzeugwagen mit sieben Schubladen,
komplett aus Edelstahl, Abriebfeste Räder

Haupteigenschaften:

- Sieben Schubladen mit Teleskopführungen, kugelgelagert, 570 x 410 mm:
- 6 Schubladen Höhe 83 mm;
- 1 Schublade Höhe 170 mm;
- 4 Räder Ø 125 mm
- 2 starre und 2 lenkbare (davon 2 gebremst);
- Zentralverriegelung mit vorderem Schloss;
- Struktur vollständig aus Edelstahl;
- Räder, Halterungen, Kugeln, Schubladen innen und Führungen aus Edelstahl;
- Schubladengriff aus Aluminium.

63 kg

Beta
INOX
STAINLESS STEEL

700
kg



h	max
83 mm	25 kg
170 mm	30 kg

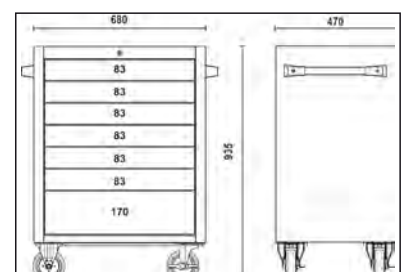
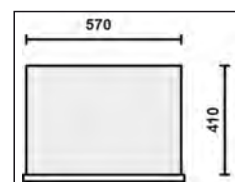

C04TSS/7

€ 3.100,00 1 024003077



KUPFER-BERYLLIUM Cu-Be

Die funkenfreien Werkzeuge n sind spezifisch dazu geeignet, absolut sicher in explosionsgefährdeten Räumen mit brennbaren Flüssigkeiten oder Gasen oder für Anwendungen, welche den Einsatz von nicht magnetischen und korrosionsbeständigen Werkzeugen erfordern, verwendet zu werden.

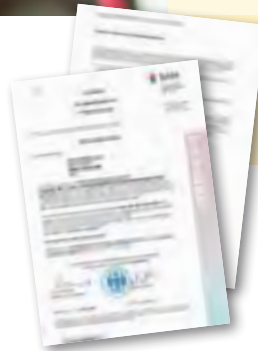

Die funkenfreien Werkzeuge Beta sind von der Bundesanstalt für Materialforschung und -prüfung BAM gemäß der Europäischen Richtlinie 99/92/EC zertifiziert



HINWEIS!
Explosionsgefahr bei Vorkommen von **ACETYLEN**

Die funkenfreien Werkzeuge haben andere mechanische Eigenschaften als die normalen Stahlwerkzeuge. Es wird empfohlen, sie stets mit besonderer Vorhut zu benutzen und Überlasten zu vermeiden.

KLASSIFIKATION DER EXPLOSIONSGEFÄHRDETEN ZONEN

		MITTEL NIEDRIG		SEHR NIEDRIG	
ATEX	GASE	ZONE 1 Bereich, in dem sich bei Normalbetrieb gelegentlich eine explosionsfähige Atmosphäre als Gemisch aus Luft und brennbaren Gasen, Dämpfen oder Nebeln bilden kann.		ZONE 2 Bereich, in dem bei Normalbetrieb eine explosionsfähige Atmosphäre in Form einer Wolke aus Luft und brennbaren Gasen, Dämpfen oder Nebeln normalerweise nicht oder nur kurzzeitig auftritt.	
		STÄUBE	ZONE 21 Bereich, in dem sich bei Normalbetrieb gelegentlich eine explosionsfähige Atmosphäre in Form einer Wolke aus in der Luft enthaltenem brennbaren Staub bilden kann.		ZONE 22 Bereich, in dem bei Normalbetrieb eine explosionsfähige Atmosphäre in Form einer Wolke aus in der Luft enthaltenem brennbaren Staub normalerweise nicht oder nur kurzzeitig auftritt.

30BA

Durchschläger, funkenfrei



Ø mm	L mm	S mm	€	U	IP
5	150	15	73,50	1	000300806
8	150	17	91,00	1	000300808
10	150	19	112,50	1	000300810

31BA

Splinttreiber, funkenfrei



Ø mm	L mm	€	U	IP
3	110	32,00	1	000310853
4	110	69,00	1	000310854
6	115	106,00	1	000310856
8	120	119,50	1	000310858

31BA/C

Konische Durchschläger, funkenfrei



Ø mm	Ø1 mm	L mm	€	U	IP
*6	12	150	43,50	1	000310876
*7	13	150	51,00	1	000310877
*12	18	175	108,50	1	000310882
*13	29	255	340,00	1	000310883

32BA

Körner, funkenfrei



Ø mm	L mm	€	U	IP
14	150	101,50	1	000320811

34BA

Flachmeißel, funkenfrei



L mm	A mm	€	U	IP
200	22	138,00	1	000340801
250	24	230,50	1	000340803
300	25	311,00	1	000340802

39BA

Keile, funkenfrei



L mm	A mm	€	🔧	📄
150	40	60,00	1	000390801
230	40	202,50	1	000390802
250	40	317,00	1	000390803

42BA

Ring-Maulschlüssel, funkenfrei



🔧 mm	L mm	€	🔧	📄
6x6	105	64,00	1	000420806
7x7	105	72,50	1	000420807
8x8	120	81,00	1	000420808
9x9	120	92,50	1	000420809
10x10	135	101,00	1	000420810
11x11	135	106,00	1	000420811
12x12	150	116,00	1	000420812
13x13	150	119,50	1	000420813
14x14	175	125,50	1	000420814
15x15	175	132,00	1	000420815
16x16	195	137,00	1	000420816
17x17	200	143,50	1	000420817
18x18	215	161,00	1	000420818
19x19	220	164,50	1	000420819
20x20	230	171,00	1	000420820
21x21	240	181,50	1	000420821
22x22	250	193,50	1	000420822
24x24	268	224,50	1	000420824
26x26	290	271,00	1	000420826
27x27	290	302,00	1	000420827
28x28	290	354,00	1	000420828
30x30	313	362,00	1	000420830
32x32	333	399,00	1	000420832
34x34	360	433,00	1	000420834
35X35	360	492,00	1	000420835
36x36	355	513,00	1	000420836
38x38	430	541,00	1	000420838
41x41	430	636,00	1	000420841
46x46	480	744,00	1	000420846
50x50	520	787,00	1	000420850
55x55	560	867,00	1	000420855
60x60	580	925,00	1	000420860
*65x65	595	1.055,00	1	000420865
*70x70	630	1.184,00	1	000420870

42BA-AS

Ring-Maulschlüssel, funkenfrei



🔧 mm	L mm	€	🔧	📄
9/32x9/32	120	69,00	1	000420946
5/16x5/16	120	69,00	1	000420947
11/32x11/32	135	88,00	1	000420948
3/8x3/8	128	93,00	1	000420950
7/16x7/16	135	106,00	1	000420951

🔧 mm	L mm	€	🔧	📄
15/32x15/32	140	116,50	1	000420949
1/2x1/2	140	121,00	1	000420953
9/16x9/16	163	131,00	1	000420954
*19/32x19/32	195	157,00	1	000420955
5/8x5/8	177	158,00	1	000420956
11/16x11/16	195	169,00	1	000420957
3/4x3/4	215	174,00	1	000420959
13/16x13/16	230	203,00	1	000420961
7/8x7/8	235	210,00	1	000420962
15/16x15/16	256	234,00	1	000420964
*31/32x31/32	265	257,00	1	000420963
1x1	266	253,00	1	000420965
1.1/16x1.1/16	283	285,00	1	000420967
1.1/8x1.1/8	297	375,00	1	000420969
1.3/16x1.3/16	308	405,00	1	000420970
1.1/4x1.1/4	324	478,00	1	000420973
*1.7/16x1.7/16	360	579,00	1	000420976

55BA

Doppelmaulschlüssel, funkenfrei



🔧 mm	L mm	€	🔧	📄
6x7	90	44,50	1	000550801
8x9	100	47,50	1	000550802
8x10	100	49,00	1	000550795
9x11	110	52,50	1	000550797
10x11	120	56,00	1	000550803
12x13	130	70,00	1	000550804
*12x14	130	85,50	1	000550846
13x14	133	84,50	1	000550799
14x15	145	85,50	1	000550805
14x17	150	91,00	1	000550806
16x17	165	92,00	1	000550807
17x19	170	121,00	1	000550847
18x19	170	123,50	1	000550809
*19x22	185	141,00	1	000550810
20x22	185	142,00	1	000550811
21x23	210	155,00	1	000550813
22x24	210	185,00	1	000550815
24x26	230	216,00	1	000550817
24x27	230	231,00	1	000550818
25x28	230	251,00	1	000550819
27x29	246	293,00	1	000550820
30x32	265	342,00	1	000550822
36x38	320	433,00	1	000550826
36x41	335	478,00	1	000550828
41x46	355	593,00	1	000550829
*46x50	370	679,00	1	000550830
*50x55	385	723,00	1	000550831
*55x60	415	897,00	1	000550832

55BA-AS

Doppelmaulschlüssel, funkenfrei



🔧 mm	L mm	€	🔧	📄
3/8x7/16	110	58,00	1	000550853
1/2x9/16	130	69,00	1	000550854
5/8x11/16	160	101,50	1	000550857
3/4x13/16	180	125,50	1	000550859
7/8x15/16	210	176,50	1	000550865
1x1.1/16	230	239,00	1	000550868
1.1/8x1.3/16	245	311,00	1	000550870
1.1/4x1.5/16	255	367,00	1	000550872

58BA

Einfache Schlagmaulschlüssel, funkenfrei



🔧 mm	L mm	€	🔧	📄
17	125	118,50	1	000580817
19	125	123,00	1	000580819
22	135	123,50	1	000580822
24	150	139,00	1	000580824
27	165	170,50	1	000580827
30	180	214,00	1	000580830
32	190	251,00	1	000580832
*34	200	286,00	1	000580834
36	210	296,00	1	000580836
38	220	326,00	1	000580838
41	230	367,00	1	000580841
46	240	441,00	1	000580846
50	255	500,00	1	000580850
*55	305	622,00	1	000580855
*60	315	723,00	1	000580860
*65	335	840,00	1	000580865
*70	370	1.012,00	1	000580870
*75	375	1.171,00	1	000580875
*80	400	1.405,00	1	000580880
*85	400	1.650,00	1	000580885
*90	445	1.960,00	1	000580890
*95	445	2.265,00	1	000580895
*100	485	2.630,00	1	000580900
*110	513	3.250,00	1	000580901

58BA-AS



🔧 mm	L mm	A mm	S mm	€	🔧	📄
*11/16	125	40,5	11,0	131,00	1	000580904
*3/4	125	40,5	11,0	133,00	1	000580905
*7/8	135	46,2	12,0	136,50	1	000580906
*15/16	150	50,3	12,0	156,00	1	000580907
*31/32	150	50,3	12,0	175,00	1	000580954
*1	175	56,9	15,0	181,00	1	000580908
*1.1/8	190	64,0	15,5	232,00	1	000580909
*1.1/4	190	64,0	15,5	273,00	1	000580910
*1.7/16	210	75,0	18,5	317,00	1	000580912
*1.1/2	220	82,0	18,5	376,00	1	000580913
*1.5/8	230	86,8	18,5	405,00	1	000580914
*1.3/4	250	98,0	20,	513,00	1	000580970

78BA

Zwölfkant-Schlagringschlüssel, funkenfrei



🔧 mm	L mm	€	🔧	📄
17	145	124,00	1	000780817
19	145	136,00	1	000780819
22	165	138,00	1	000780822
24	140	169,00	1	000780824
27	155	194,00	1	000780827
30	165	225,00	1	000780830
32	180	244,00	1	000780832
34	192	268,00	1	000780834
36	208	296,00	1	000780836
38	215	347,00	1	000780838
41	225	413,00	1	000780841
46	245	462,00	1	000780846
50	250	536,00	1	000780850

Ø mm	L mm	€	U	U
55	265	622,00	1	000780855
60	275	673,00	1	000780860
65	295	723,00	1	000780865
70	310	818,00	1	000780870
75	325	919,00	1	000780875
80	340	983,00	1	000780880
*85	355	1.250,00	1	000780885
*90	380	1.470,00	1	000780890
*95	390	1.705,00	1	000780895
*100	410	1.945,00	1	000780900
*105	420	2.150,00	1	000780903
*110	445	2.455,00	1	000780901
*120	480	2.910,00	1	000780902

78BA-AS

Zwölfkant-Schlagringschlüssel, funkenfrei



Ø mm	L mm	€	U	U
11/16	145	122,50	1	000780908
3/4	145	127,00	1	000780909
7/8	155	142,00	1	000780935
15/16	165	157,00	1	000780936
*31/32	165	183,00	1	000780937
1	175	183,00	1	000780938
*1.1/16	175	217,00	1	000780939
1.1/8	180	220,00	1	000780940
1.3/16	185	229,00	1	000780941
1.1/4	177	249,00	1	000780910
*1.5/16	200	254,00	1	000780954
*1.3/8	205	265,00	1	000780911
1.7/16	208	330,00	1	000780912
*1.1/2	215	344,00	1	000780913
*1.9/16	225	428,00	1	000780947
*1.11/16	225	451,00	1	000780962
1.5/8	225	419,00	1	000780914
*1.3/4	235	462,00	1	000780963
1.13/16	243	478,00	1	000780916
1.7/8	235	541,00	1	000780915
2	254	562,00	1	000780918
2.3/16	264	657,00	1	000780920
2.3/8	275	716,00	1	000780922
*2.9/16	286	744,00	1	000780924
*2.15/16	311	903,00	1	000780926
*3.1/8	325	1.048,00	1	000780928
*3.1/2	355	1.325,00	1	000780930

89BA

Einringsschlüssel, funkenfrei



Ø mm	L mm	€	U	U
10	200	140,50	1	000890810
11	210	145,50	1	000890811
12	220	151,00	1	000890812
13	230	155,00	1	000890813
14	240	157,00	1	000890814
16	260	169,00	1	000890816
17	270	175,00	1	000890817
18	280	189,00	1	000890818
19	300	195,00	1	000890819
20	310	244,00	1	000890820
22	330	244,00	1	000890822
24	350	267,00	1	000890824
27	370	329,00	1	000890827
30	400	367,00	1	000890830
32	420	386,00	1	000890832

90BA

Doppelringsschlüssel, gekröpft, funkenfrei



Ø mm	L mm	€	U	U
6x7	122	45,00	1	000900801
8x9	128	58,00	1	000900802
10x11	155	65,00	1	000900803
12x13	175	76,50	1	000900806
12x14	180	82,00	1	000900807
14x15	200	92,00	1	000900808
14x17	220	93,50	1	000900809
16x17	230	111,00	1	000900811
16x18	235	111,00	1	000900812
17x19	250	114,00	1	000900814
18x19	265	126,00	1	000900815
19x22	280	132,00	1	000900817
20x22	295	150,00	1	000900818
21x23	298	159,00	1	000900820
22x24	315	191,00	1	000900821
24x26	333	246,00	1	000900822
24x27	340	246,00	1	000900823
30x32	395	362,00	1	000900824
34x36	410	513,00	1	000900826
*36x41	450	694,00	1	000900828
*41x46	470	853,00	1	000900829
*46x50	490	946,00	1	000900830

91BA

Aufsteckringsschlüssel, funkenfrei



Ø mm	Ø mm	€	U	U
24	38	296,00	1	000910824
27	42	354,00	1	000910827
30	48	405,00	1	000910830
32	49	453,00	1	000910832
36	54	492,00	1	000910836
41	62	551,00	1	000910841
*46	69	730,00	1	000910846
*50	75	781,00	1	000910850
*55	82	903,00	1	000910855

92BA

Aufsteckrohr für Art. 91BA, funkenfrei



	L mm	91BA mm	Ø mm	€	U	U
92BA/1	460	24÷30	25	351,00	1	000920810
92BA/2	610	32÷41	28	452,00	1	000920820
*92BA/3	760	46÷55	32	607,00	1	000920830

93BA

Doppelknarrenringsschlüssel, flach gekröpft, speziell für Gerüste



Ø mm	L mm	€	U	U
21x22	345	730,00	1	000930821

95BA

Doppelringsschlüssel, gerade, funkenfrei



Ø mm	L mm	€	U	U
7x9	115	44,50	1	000950801
8x10	115	49,00	1	000950802
10x11	140	54,00	1	000950804
10x12	140	64,00	1	000950805
12x14	145	73,50	1	000950806
14x17	165	88,00	1	000950807
*16x18	170	115,00	1	000950809
*17x19	185	101,00	1	000950808
*18x19	185	126,00	1	000950810
*19x22	200	156,00	1	000950812
*21x23	230	172,00	1	000950815
*24x27	255	220,00	1	000950817
*30x32	295	330,00	1	000950820

96BA

Sechskant-Stiftschlüssel, gebogen, funkenfrei

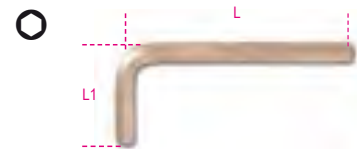

mm	L mm	L1 mm	€	U	U
1,5	50	17	91,00	1	000960760
2	50	16	92,50	1	000960762
2,5	56	20	99,00	1	000960761
3	63	21	102,00	1	000960763
4	69	25	107,00	1	000960764
5	78	29	111,00	1	000960765
6	88	33	113,00	1	000960766
7	93	34	119,00	1	000960767
8	97	36	126,00	1	000960768
9	104	37	132,00	1	000960769
10	110	39	136,00	1	000960770
11	118	42	145,00	1	000960771
12	122	44	165,00	1	000960772
14	150	58	185,00	1	000960774
15	156	60	195,00	1	000960775
16	162	63	214,00	1	000960776
17	168	65	225,00	1	000960777
19	177	72	252,00	1	000960779
22	186	77	294,00	1	000960802
24	192	82	340,00	1	000960804

96BA/BP

Sechskant-Stiftschlüssel, gebogen, mit kugelförmigem Kopf, funkenfrei



Ø mm	L mm	L1 mm	€	U	U
1,5	50	16	93,00	1	000961800
2	50	16	93,50	1	000961801
2,5	63	20	106,50	1	000961802
3	60	20	107,00	1	000961803
3,5	70	25	111,50	1	000961799
4	66	25	112,00	1	000961804
5	75	28	114,00	1	000961805
6	84	32	118,00	1	000961806
8	92	36	128,00	1	000961808
10	102	40	138,00	1	000961810
12	113	45	171,00	1	000961812

96BAF-AS

Sechskant-Stiftschlüssel, gebogen, funkenfrei



mm	L mm	L1 mm	€		
*1/16	59	25	73,50	1	000962831
*5/64	59	25	76,00	1	000962832
*3/32	59	25	79,00	1	000962833
*7/64	59	25	82,50	1	000962834
*1/8	59	25	86,00	1	000962835
*9/64	64	29	92,50	1	000962836
*5/32	65	30	95,50	1	000962837
*3/16	79	31	102,00	1	000962838
*7/32	85	37	106,00	1	000962839
*1/4	85	37	111,00	1	000962840
9/32	88	38	114,00	1	000962841
*5/16	92	44	119,00	1	000962842
11/32	100	44	123,00	1	000962843
*3/8	110	45	130,00	1	000962844
*7/16	119	48	138,00	1	000962845
*1/2	140	55	169,00	1	000962846
*9/16	150	58	194,00	1	000962847

99BA

Hakenschlüssel mit Nase, funkenfrei



mm	A mm	€		
32-75	4,0	240,00	1	000990803
50-120	4,5	376,00	1	000990805
115-170	4,5	608,00	1	000990811

110BA

Einmaulschlüssel, verstellbar, funkenfrei



L mm	A max	€		
100	13	178,00	1	001100810
150	18	204,00	1	001100815
200	24	240,00	1	001100820
250	30	290,00	1	001100825
300	36	406,00	1	001100830
375	46	548,00	1	001100837
*450	55	766,00	1	001100845
*600	65	1.280,00	1	001100860

330BA

Rohrschneider, funkenfrei



mm	max 50 mm	L mm	€		
330BA/2	2"	375	933,00	1	003300802

330BA/2R

Messer und Ersatzstecker für Art. 330BA für Gasrohre, funkenfrei



mm	€		
330BA /2-R	93,50	1	003300822

363BA

Rohrzangen, amerikanisches Modell, funkenfrei



L mm	Ø max	Ø max mm	€		
150	1/2" gas	20	303,00	1	003630815
200	1" gas	30	304,00	1	003630820
250	1 1/2" gas	49	354,00	1	003630825
300	2" gas	60	450,00	1	003630830
350	2" gas	60	556,00	1	003630835
450	2 1/2" gas	76	844,00	1	003630845
600	3" gas	90	1.177,00	1	003630860

378BA

Rohrzange, schwedisches Modell, funkenfrei, Legierung aus Kupfer und Beryllium



L mm	Ø max"	€		
430	1" 1/2 gas	920,00	1	003780800
530	2" gas	1.135,00	1	003780801

386BA

Kettenrohrzangen, schwere Ausführung, funkenfrei



L mm	Ø max mm	L1 mm	€		
600	100	470	1.390,00	1	003860806
900	200	750	2.305,00	1	003860809

911BA

Zwölfkant-Steckschlüssel, funkenfrei



mm	L mm	€		
6	28	61,50	1	009110806
7	28	65,00	1	009110807
8	28	70,00	1	009110808
9	28	74,50	1	009110809
10	32	102,00	1	009110810
11	32	108,00	1	009110811
12	32	114,00	1	009110812
13	32	119,00	1	009110813
14	32	126,00	1	009110814
15	32	127,00	1	009110815
16	32	133,00	1	009110816
17	32	138,00	1	009110817
18	32	141,00	1	009110818
19	32	146,00	1	009110819

911BA/16

Verbindungsstück, Innenvierkant 3/8", Außenvierkant 1/2", funkenfrei



L mm	3/8	1/2	€		
34			130,00	1	009110836

911BA/20

Verlängerung, Innen- und Außenvierkant 3/8", funkenfrei



L mm	€		
75	105,00	1	009110840

911BA/55

Einfachknarre mit Innenvierkanttrieb 3/8", funkenfrei



L mm	D mm	A mm	€		
200	45	16.5	223,00	1	009110882



921BA

Zwölfkant-Steckschlüssel, funkenfrei



mm	Ø mm	L mm	€	1	009210808
8	15,0	40	92,50	1	009210808
9	16,0	40	97,50	1	009210809
10	17,5	40	112,00	1	009210810
11	18,0	40	115,00	1	009210811
12	18,5	40	123,00	1	009210812
13	20,0	40	130,00	1	009210813
14	21,0	40	132,00	1	009210814
15	21,5	40	137,00	1	009210815
16	24,0	40	142,00	1	009210816
17	25,0	40	147,00	1	009210817
18	25,0	40	153,00	1	009210818
19	28,0	42	157,00	1	009210819
20	29,0	42	165,00	1	009210820
21	30,0	43	168,00	1	009210821
22	30,5	43	175,00	1	009210822
24	34,0	43	205,00	1	009210824
25	36,0	43	223,00	1	009210825
26	37,5	43	238,00	1	009210826
27	37,5	45	249,00	1	009210827
28	38,9	46	261,00	1	009210828
30	41,5	46	293,00	1	009210830
32	43,5	46	323,00	1	009210832

921BA-AS

Zwölfkant-Steckschlüssel, funkenfrei

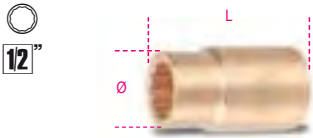

"	Ø mm	L mm	€	1	009210958
5/16	24,0	40	98,50	1	009210958
3/8	24,0	40	107,00	1	009210960
7/16	24,0	40	116,00	1	009210961
1/2	24,0	40	124,00	1	009210963
9/16	24,0	40	130,00	1	009210964
5/8	25,0	40	147,00	1	009210966
11/16	25,5	40	158,00	1	009210967
3/4	28,0	42	175,00	1	009210969
13/16	30,0	43	185,00	1	009210971
7/8	31,5	43	202,00	1	009210972
15/16	34,0	43	213,00	1	009210974
1	36,0	43	238,00	1	009210975
1.1/16	38,0	46	256,00	1	009210977
1.1/4	42,0	46	340,00	1	009210982
1.7/16	50,5	50	419,00	1	009210986

921BA/15

Verbindungsstück, Innenvierkant 1/2", Außenvierkant 3/8", funkenfrei



L mm	1/2"	3/8"	€	1	009210839
34			117,00	1	009210839

921BA/16

Verbindungsstück, Innenvierkant 1/2", Außenvierkant 3/4", funkenfrei



L mm	1/2"	3/4"	€	1	009210840
34			154,00	1	009210840

921BA/21 - 921BA/22

Verlängerungen, Innen- und Außenvierkant 1/2", funkenfrei



	L mm	Ø mm	€	1	009210842
921BA/21	125	30	156,00	1	009210842
921BA/22	250	31	217,00	1	009210844

921BA/25

Kardangeln, Innen- und Außenvierkant 1/2", funkenfrei



L mm	Ø mm	1/2"	1/2"	€	1	009210845
80	25			158,00	1	009210845

921BA/42

Gleitgriff, Außenvierkant 1/2", funkenfrei



L mm	€	1	009210846
250	258,00	1	009210846

921BA/50

Einfachknaur mit Innenvierkanttrieb 1/2", funkenfrei



L mm	D mm	A mm	€	1	009210850
250	45	16,5	296,00	1	009210850

921BA/R50

Ersatzteile-Satz, funkenfrei



1/2"	€	1	009210851
	88,50	1	009210851

926BA

Zwölfkant-Steckschlüssel, funkenfrei



mm	Ø mm	L mm	€	1	009260822
22	40	55	194,00	1	009260822
24	40	55	216,00	1	009260824
26	40	55	246,00	1	009260826
27	40	55	261,00	1	009260827
28	41	55	304,00	1	009260828
30	43	60	311,00	1	009260830
32	45	60	347,00	1	009260832
34	48	60	369,00	1	009260834
36	50	60	401,00	1	009260836
38	53	60	428,00	1	009260838
41	57	65	469,00	1	009260841
46	63	65	557,00	1	009260846
50	68	70	610,00	1	009260850

926BA/15

Verbindungsstück, Innenvierkant 3/4", Außenvierkant 1/2", funkenfrei



L mm	3/4"	1/2"	€	1	009260861
55			154,00	1	009260861

926BA/22

Verlängerungen, Innen- und Außenvierkant 3/4", funkenfrei



	L mm	Ø mm	€	1	009260872
926BA/22	200	38	311,00	1	009260872

926BA/42

Gleitgriff, Außenvierkant 3/4", funkenfrei



L mm	€	1	009260876
400	451,00	1	009260876

926BA/50

Einfachknarre mit Gleitvierkant 3/4", funkenfrei



L mm	D mm	A mm	€	Icon	Icon
300	61	22	461,00	1	009260880

926BA/R50

Ersatzteile-Satz, funkenfrei



3/4"	€	Icon	Icon
147,00	1	009260881	

937BA

Steckschlüssel, funkenfrei



Ø mm	L mm	A mm	€	Icon	Icon
13	240	45	115,00	1	009370813
17	260	51	166,00	1	009370817
19	270	55	174,00	1	009370819
22	278	59	228,00	1	009370822
24	286	63	244,00	1	009370824
27	294	69	259,00	1	009370827
30	302	75	285,00	1	009370830
32	310	81	311,00	1	009370832
*36	330	85	365,00	1	009370836
*41	350	90	442,00	1	009370841

951BA

Sechskant-Stiftschlüssel mit T-Griff, funkenfrei

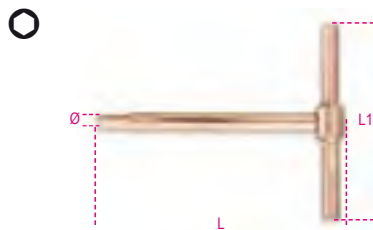

mm	L mm	L1 mm	€	Icon	Icon
4	100	90	194,00	1	009510904
5	100	90	203,00	1	009510905
6	100	90	214,00	1	009510906

961BA

Hebeleisen, funkenfrei



L mm	A mm	€	Icon	Icon
250	39	171,00	1	009610802
350	55	258,00	1	009610806

963BA

Hebeleisen, gerade, funkenfrei



L mm	A mm	€	Icon	Icon
500	24	477,00	1	009630801
*800	24	746,00	1	009630803
*1000	30	1.580,00	1	009630805

964BA

Fassöffner, funkenfrei



L mm	€	Icon	Icon
385	451,00	1	009640801

964BA/L

Universalschere für Fässer, funkenfrei
Zum Öffnen von Metallfässern mit Kante



*964BA/L	L mm	€	Icon	Icon
	510	2.270,00	1	009640821

965BA

Einfache Schlüssel für Sicherheitsventile, funkenfrei



A mm	A1 mm	L mm	€	Icon	Icon
30	44	200	197,00	1	009650830
32	50	300	276,00	1	009650832
35	47	250	225,00	1	009650835
40	50	300	259,00	1	009650840
45	58	350	333,00	1	009650845
48	62	375	347,00	1	009650848
50	67	400	381,00	1	009650850

A mm	A1 mm	L mm	€	Icon	Icon
55	73	450	456,00	1	009650855
60	79	500	492,00	1	009650860
*65	82	550	551,00	1	009650865
*70	85	600	608,00	1	009650870

966BA

Schlüssel für Sicherheitsventile, funkenfrei

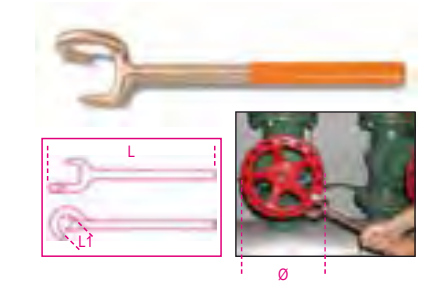

L mm	L1 mm	Ø min+max mm	€	Icon	Icon
350	40	50+150	432,00	1	009660801

966BA/V

Schlüssel für Sicherheitsventile, funkenfrei

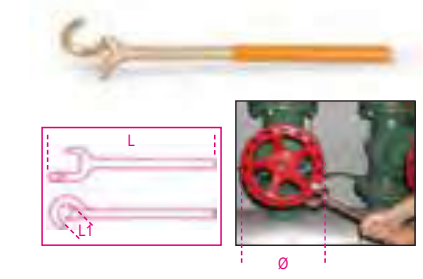

L mm	L1 mm	Ø min+max mm	€	Icon	Icon
370	36	125+250	432,00	1	009660812
430	48	250+400	622,00	1	009660814

1032BA

Zangen mit geraden Backen, für Sicherungsringe mit Innenspannung, Griffe mit PVC-Überzug, funkenfrei



L mm	Ø mm	€	Icon	Icon
200	40+100	282,00	1	010320820

1036BA

Zangen mit geraden Backen, für Sicherungsringe mit Außenspannung, Griffe mit PVC-Überzug, funkenfrei



L mm	Ø mm	€	Icon	Icon
200	40+100	282,00	1	010360820

1046BA

Verstellbare Zangen,
funkenfrei

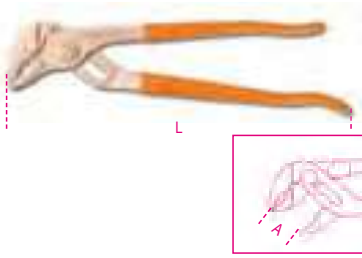

L mm	A max mm	€	🔧	📦
250	32	367,00	1	010460801
★300	52	485,00	1	010460803

1052BA

Gripzangen, verstellbar,
konkave Backen, funkenfrei

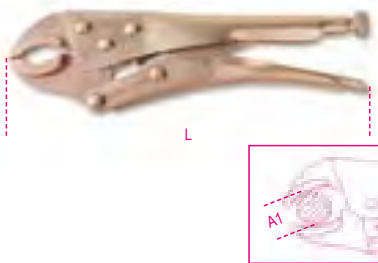

L mm	A1 max mm	€	🔧	📦
225	40,0	362,00	1	010520824

1082BA

Diagonalseitenschneider, funkenfrei

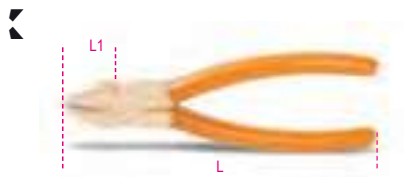

L mm	L1 mm	€	🔧	📦
160	22	264,00	1	010820801

1100BA

Bolzenschneider,
funkenfrei



L mm	€	🔧	📦
600	1.880,00	1	011000860

1137BA

Schusszange



L mm	L1 mm	€	🔧	📦
185	30	490,00	1	011370801

1137BA/RC

Ersatzschneide für Art. 1137BA



1137BA/RC	€	🔧	📦
	93,50	1	011370851

1150BA

Universalzange, funkenfrei

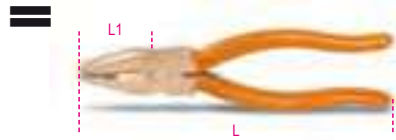

L mm	L1 mm	€	🔧	📦
200	40	310,00	1	011500820

1162BA

Flachzangen mit geraden Backen,
extralang, innengeriffelt, funkenfrei



L mm	L1 mm	€	🔧	📦
150	54	244,00	1	011620815

1166BA

Zangen mit halbrunden Backen,
extralang, gerade, innengeriffelt, funkenfrei



L mm	L1 mm	€	🔧	📦
150	54	244,00	1	011660815

1270BA

Schraubendreher für Schlitzschrauben,
funkenfrei



AxL mm	L1 mm	€	🔧	📦
3x75	178	44,50	1	012700803
4x100	209	54,00	1	012700804
5x150	250	72,50	1	012700805
6x150	270	76,50	1	012700806
10x250	382	117,00	1	012700810
8x200	312	87,00	1	012700808

1272BA

Schraubendreher
für Phillips®-Schrauben, funkenfrei

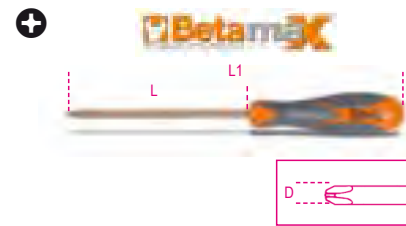

PHxDxL mm	L1 mm	€	🔧	📦
1x5x100	209	60,50	1	012720801
2x6x150	270	77,50	1	012720802
3x8x200	332	93,00	1	012720803

1277BA

Schraubendreher für Torx®-Schrauben,
funkenfrei

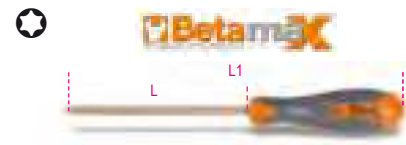

Ø	L mm	L1 mm	Ø mm	€	🔧	📦
T10	75	184	5	58,00	1	012770810
T15	75	184	5	62,50	1	012770815
T20	100	209	6	84,50	1	012770820
T25	125	209	6	89,00	1	012770825
T30	150	270	6	98,00	1	012770830
T40	200	332	8	131,00	1	012770840

1370BA

Mechanikerhammer, funkenfrei,
Stiel aus Holz



g	A mm	L mm	L1 mm	€	🔧	📦
500	30	310	108	163,00	1	013700805
1000	35	340	137	286,00	1	013700810

1370BA/MR

Ersatzstiele für Art. 1370BA

	€		
1370BA/MR 500 1370BA/500	27,50	1	013700865
1370BA/MR 1000 1370BA/1000	33,50	1	013700870

1370BA/PL

Mechanikerhammer, funkenfrei,
Stiel aus Fasern



g	A mm	L mm	L1 mm	€		
500	30	310	108	163,00	1	013700815
1000	35	340	137	286,00	1	013700820

1375BA/PL

Klauenhammer mit kugelförmiger Pinne,
funkenfrei,
Stiel aus Fasern



g	L mm	L1 mm	Ø mm	€		
680	321	125	30	209,00	1	013750800

1377BA

Hammer für Blechbearbeitung,
amerikanisches Modell,
mit rundem Kopf und kugelförmiger Pinne,
funkenfrei



g	L1 mm	L mm	€		
340	90	280	105,00	1	013770834

1377BA/PL

Hammer für Blechbearbeitung,
amerikanisches Modell,
mit rundem Kopf und kugelförmiger Pinne,
Stiel aus Faser,
funkenfrei



g	L1 mm	L mm	€		
340	90	280	105,00	1	013770884

1379BA

Entrostungshammer, funkenfrei,
Stiel aus Holz



g	L1 mm	L mm	€		
500	142	315	203,00	1	013790850

1380BA

Fäustel, funkenfrei,
Stiel aus Holz



g	L1 mm	L mm	€		
1000	100	400	351,00	1	013800810
1500	118	400	428,00	1	013800815
2000	126	400	562,00	1	013800820

1380BA/MR

Ersatzstiele für Art. 1380BA

	€		
1380BA/MR 1000 1380BA/1000	35,50	1	013800860
1380BA/MR 1500 1380BA/1500	35,50	1	013800865
1380BA/MR 2000 1380BA/2000	35,50	1	013800870

1380BA/PL

Fäustel, funkenfrei,
Stiel aus Fasern



g	L1 mm	L mm	€		
500	80	310	175,00	1	013800955
1000	94	350	326,00	1	013800960
1500	115	400	469,00	1	013800965
2000	125,5	400	614,00	1	013800970

1381BA

Fäustel, funkenfrei,
Stiel aus Holz



g	L1 mm	L mm	€		
5000	179	900	1.310,00	1	013810850
*8000	190	900	2.100,00	1	013810858

1381BA/MR

Ersatzstiel für Art. 1381BA

	€		
1381BA/MR 5000 1381BA/5000	54,00	1	013810870
*1381BA/MR 8000 1381BA/8000	63,00	1	013810878

1381BA/PL

Fäustel, funkenfrei,
Stiel aus Fasern



g	L1 mm	L mm	€		
5000	172	900	1.199,00	1	013810885
8000	204	900	2.150,00	1	013810888

1390BA

Hammer mit Kunststoffaufsätzen, funkenfrei



Ø mm	L mm	L1 mm	€		
*52	370	130	282,00	1	013900805

1390BA/R

Ersatzaufsätze aus Nylon, für Art. 1390BA



D mm	€		
52	57,00	4	013900885



1602BA

Anpresszange für isolierte Kabelverbindungen, leichte Ausführung, funkenfrei



mm ²	L mm	€	U	PC
0.75÷6	200	346,00	1	016020801

1701BA

Sechskant-Flachmeißel, funkenfrei



L mm	A mm	S mm	€	U	PC
150	12	10	63,50	1	017010810
200	16	14	102,00	1	017010814
250	18	14	126,00	1	017010815
350	19	17	330,00	1	017010817

1703BA/A

Funkenfreie Axt



L mm	L1 mm	A mm	€	U	PC
340	145	82	286,00	1	017030082

1703BA/P

Hacken, funkenfrei



A mm	L mm	L1 mm	€	U	PC
56	1050	410	747,00	1	017030150

1703BA/PL

Schaufel, funkenfrei



A mm	L1 mm	L mm	€	U	PC
240	420	990	630,00	1	017030200

1717BA

Spachtel, starr, funkenfrei



A mm	€	U	PC
60	154,00	1	017170801
80	171,00	1	017170803

1717BA/1

Stoßschaber, funkenfrei

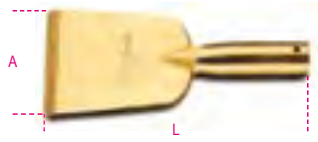

A mm	L mm	€	U	PC
100	220	307,00	1	017170805

1719BA8

Feilen, 8", funkenfrei

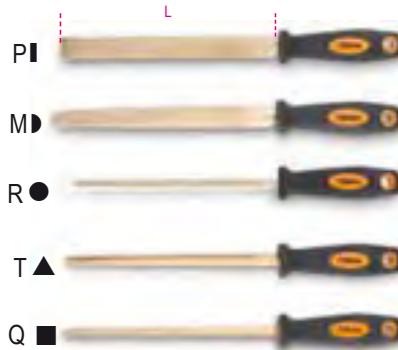

	L mm	€	U	PC
1719BA8/P	200	189,00	1	017190801
1719BA8/M	200	195,00	1	017190805
1719BA8/R	200	199,00	1	017190810
1719BA8/T	200	183,00	1	017190815
1719BA8/Q	200	183,00	1	017190820

1719BA12

Feilen, 12", funkenfrei



	L mm	€	U	PC
1719BA12/P	300	340,00	1	017190831

1727BA

Sägebogen und Sägeblatt, funkenfrei

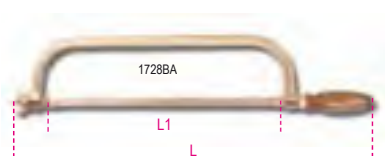

L mm	L1 mm	€	U	PC
500	300	599,00	1	017270801

1728BA

Sägeblätter, funkenfrei, Legierung aus Kupfer und Beryllium



L mm	€	U	PC
300	117,00	1	017280801

1737BA

Zündkerzenbürste, funkenfrei



L mm	A mm	€	U	PC
294	29	77,50	1	017370801

1758BA

Funkenfreier Trichter



Ø mm	H mm	€	U	PC
160	150	109,00	1	017580815

1776BA

Messer, funkenfrei



L1 mm	L mm	€	U	PC
145	250	169,00	1	017760801

1784BA

Schere, funkenfrei



L mm	€	U	PC
225	293,00	1	017840822





ELEKTROWERKZEUGE

Zuverlässige und langlebige Arbeitsgeräte, die den Arbeitsanforderungen eines jeden Profis gerecht werden.

Die Elektrowerkzeugfamilie von Beta umfasst

AKKU-WERKZEUGE

KABELGEBUNDENE WERKZEUGE



Beta
POWERTOOLS

AKKU-WERKZEUGE

Beta
3-YEAR
WARRANTY



Das neue Sortiment an Akkugeräten umfasst leistungsstarke Maschinen in den Spannungsklassen 12 V und 20 V.

Zur **Linie 12 V** gehören der Bohrschrauber und der Bithalter-Schraubendreher, die dank ihrer Leistung, Leichtigkeit und Kompaktheit die tägliche Arbeit erleichtern und unverzichtbar sind.

Die **Linie 20 V** umfasst Akkugeräte für Arbeiten, die **hohe Leistung, beste Qualität, Zuverlässigkeit und Langlebigkeit** verlangen.

Auf dieser Grundlage hat Beta seine neue Produktreihe entwickelt, die ein komplettes Sortiment an Akku-Werkzeugen umfasst, vom Schraubendreher mit hohem Drehmoment bis zum Impulsschrauber mit 1/2"-Vierkantantrieb.

Alle neuen Elektrowerkzeuge von Beta sind mit bürstenlosen Motoren (Brushless) und hochwertigen internen Mechanismen ausgestattet, die eine deutliche Leistungssteigerung und eine längere Lebensdauer der Werkzeuge gewährleisten.

Das Elektrowerkzeug, das die neue Linie am besten repräsentiert, ist sicherlich der Impulsschrauber mit einem maximalen Ausdrehmoment von **1200 Nm**, der ideale Arbeitspartner für alle, die maximale Kraft und Leistung suchen. Unsere Lithium-Ionen-Akkus 20 V sind mit einer Kapazität von bis zu 6 Ah erhältlich und sind für alle Werkzeuge der Serie geeignet.



Für mehr Infos zur kostenlosen 3-jährigen Garantieverlängerung den QR-Code einscannen.

1972/K12V-10

Ultrakompakter 12V-Bohrschrauber

- Ultrakompakt: nur 170 mm lang; ultraleicht: nur 1,1 kg mit Batterie und perfekt in Balance
- Doppelte mechanische Geschwindigkeit mit Stahlzahnradern und Kupplung mit 20 Positionen
- Drehmoment bis zu 30 Nm und 1300 U/min (400 U/min im 1. Gang); bohrt bis zu einem Durchmesser von 10 mm in Stahl und 20 mm in Holz
- 2Ah-Batterien und Ladeanzeige am Gerätekörper
- Rutschfester ergonomischer Griff
- Front-LED
- Spannbohrfutter 10 mm
- Gürtelclip rechts/links
- Wählschalter Eindrehen-Ausdrehen-Sperre (für den Transport)
- Geliefert im Hartschalenkoffer mit 2 Lithium-Ionen-Batterien 2 Ah und Schnellladegerät (50 Min)



1972/K12V-10

€ 294,00 1 019720112

316x254x96 mm - 2,3 kg

1982/K12V

12V-Impuls-Schlagschrauber mit Rechts- und Linkslauf

Ideal für engen Raum, hohes Anzugsmoment 80 Nm, Einhand-Gebrauch

- Ultrakompakt: nur 160 mm lang; ultraleicht: nur 1 kg mit Batterie und perfekt in Balance
- Sechskantantrieb 1/4" mit Gegenmutter
- Gürtelclip rechts/links
- Front-LED
- Wählschalter Eindrehen-Ausdrehen-Sperre (für den Transport)
- Rutschfester ergonomischer Griff
- Getriebekasten komplett aus Metall
- 2Ah-Batterien und Ladeanzeige am Gerätekörper
- Geliefert im Hartschalenkoffer mit 2 Lithium-Ionen-Batterien 2 Ah und Schnellladegerät (50 Min)



1982/K12V

€ 294,00 1 019820112

316x254x96 mm - 2,3 kg

1972/K12V-COMBO

Set mit ultrakompaktem 12V-Bohrschrauber + Impuls-Schlagschrauber 1/4" HEX (12V)

Kofferinhalt:

- 1 ultrakompakter 12V-Bohrschrauber, mit Spannbohrfutter 10 mm
- 1 12V-Impuls-Schlagschrauber, mit Sechskantantrieb 1/4"
- 2 Lithium-Ionen-Batterien 2Ah
- 1 Schnellladegerät



1972/K12V-COMBO

€ 500,00 1 019720010

310x295x100 mm - 3 kg

1972/12V-10

Ultrakompakter 12-V-Bohrschrauber (Maschinenkörper)

- Ultrakompakt: nur 170 mm lang; ultraleicht: nur 1,1 kg mit Batterie und perfekt in Balance
- Spannbohrfutter aus Metall 10 mm
- Drehmoment bis zu 30 Nm; bohrt bis zu einem Durchmesser von 10 mm in Stahl und 20 mm in Holz
- Doppelte mechanische Geschwindigkeit mit Stahlzahnradern (0-400/1300 U/min)
- 20 Positionen zur Drehmomenteinstellung
- Wählschalter Eindreihen-Ausdrehen-Sperre (für den Transport)
- Front-LED
- Rutschfester ergonomischer Griff
- Gürtelclip links/rechts

📏 790 g

1972/12V-10 € 122,00 1 019720113



1982/12V

12-V-Impuls-Schlagschrauber (Maschinenkörper) mit Rechts- und Linkslauf

Ideal für engen Raum, hohes Anzugsmoment 80 Nm, einhändig bedienbar

- Ultrakompakt: nur 160 mm lang; ultraleicht: nur 1 kg mit Batterie und perfekt in Balance
- Sechskantantrieb 1/4" mit Gegenmutter
- Gürtelclip links/rechts
- Front-LED
- Wählschalter Eindreihen-Ausdrehen-Sperre (für den Transport)
- Rutschfester ergonomischer Griff
- Getriebekasten komplett aus Metall

📏 800 g

1982/12V € 130,00 1 019820113



1994BL 12V-2AH

2Ah Lithium-Ion-Akku für 12-V-Werkzeuge

Hauptmerkmale

- Akkuspannung 12V
- Akkukapazität 2Ah
- Energiekapazität 24Wh
- Akku-Typ Li-Ion

📏 170 g

1994BL 12V-2AH € 55,00 1 019940015



1994CB 12V

Schnell-Ladegerät 12V 110V-240V

Hauptmerkmale:

- LED-Akkuladestandsanzeige
- Nominale Eingangsspannung: 110V-240V ~ 50/60Hz
- Ausgangsspannung: 12.6V
- Ladestrom: 2A
- Nominale Eingangsleistung: 35W
- Akku-Aufladezeit 2Ah: 50 min

📏 260 g

1994CB 12V € 55,00 1 019940123



1972/K20V-13BMC

Satz mit 20-V-Schlagbohrschrauber BRUSHLESS

- Digitaler BRUSHLESS-Motor (bürstenlos)
- Deutliche Leistungssteigerung, u. a.: mehr Leistung, geringerer Energieverbrauch, längere Lebensdauer des Motors, bessere Leistungsdosierung über den Druckknopf
- 3 Betriebsarten: Bohren, Schrauben und Hammerbohren
- Kompakt: nur 210 mm lang
- Rutschfester ergonomischer Griff
- Wählschalter Eindrehen-Ausdrehen-Sperre (für den Transport)
- Getriebekasten komplett aus Metall
- Integriertes LED-Licht, um auch bei schlechten Sichtverhältnissen arbeiten zu können
- Gürtelclip links/rechts
- Zusätzlicher Seitengriff für hohe Drehmomente
- Geliefert im Hartschalenkoffer mit 2 Lithium-Ionen-Batterien 4 Ah und Schnellladegerät

Hauptmerkmale:

- Maximales Drehmoment: 80 Nm
- 20 Positionen zur Drehmomenteinstellung
- Spannbohrfutter aus Metall 13 mm
- Doppelte mechanische Geschwindigkeit mit Stahlzahnradern (0-450/1650 U/min)
- Max. Bohrdurchmesser Holz 55 mm
- Max. Bohrdurchmesser Metall 13 mm
- Max. Bohrdurchmesser Mauerwerk 13 mm



VERFÜGBAR
AB MAI



1972/K20V-13BMC

€ 638,00 1 019720020

490x370x125 mm - 5,5 kg

1972/20V-13BMC

20-V-Schlagbohrschrauber BRUSHLESS (Maschinenkörper)

- Digitaler BRUSHLESS-Motor (bürstenlos)
- Deutliche Leistungssteigerung, u. a.: mehr Leistung, geringerer Energieverbrauch, längere Lebensdauer des Motors, bessere Leistungsdosierung über den Druckknopf
- 3 Betriebsarten: Bohren, Schrauben und Hammerbohren
- Kompakt: nur 210 mm lang
- Rutschfester ergonomischer Griff
- Wählschalter Eindrehen-Ausdrehen-Sperre (für den Transport)
- Getriebekasten komplett aus Metall
- Integriertes LED-Licht, um auch bei schlechten Sichtverhältnissen arbeiten zu können
- Gürtelclip links/rechts
- Zusätzlicher Seitengriff für hohe Drehmomente
- Geliefert im Hartschalenkoffer ohne Akkus/ohne Ladegerät

Hauptmerkmale:

- Maximales Drehmoment: 80 Nm
- 20 Positionen zur Drehmomenteinstellung
- Spannbohrfutter aus Metall 13 mm
- Doppelte mechanische Geschwindigkeit mit Stahlzahnradern (0-450/1650 U/min)
- Max. Bohrdurchmesser Holz 55 mm
- Max. Bohrdurchmesser Metall 13 mm
- Max. Bohrdurchmesser Mauerwerk 13 mm



VERFÜGBAR
AB MAI



1972/20V-13BMC

€ 263,00 1 019720019

490x370x125 mm - 3,6 kg

1984/K600

20V-bürstenloser Impuls-Schlagschrauber mit Rechts- und Linkslauf, 1/2-Zoll-Anschluss - 600 Nm

- Bürstenloser Digital-Motor
Leistungssteigerung, wie zum Beispiel: höhere Leistung, weniger Energieverbrauch, lange Nutzzeit des Motors, verbesserte Leistungsdosierung durch Drucktaste
- Getriebekasten komplett aus Metall
- Rutschfester ergonomischer Griff
- 12-Zoll-Außenvierkanttrieb mit Hülsenklemmring
- Rechts-/Linksdrehung mit Sicherheitstaste (für den Transport)
- Integriertes LED-Licht, um auch bei schlechten Sichtverhältnissen arbeiten zu können
- LED-Akkuladestandsanzeige
- Gürtelclip links/rechts

Einschrauben

Auswahl von 3 verschiedenen Drehmoment- und Drehzahlstellungen (niedrig - mittel - hoch):

- 1: 200 Nm; 1000 RPM
- 2: 350 Nm; 1500 RPM
- 3: 550 Nm; 1800 RPM

Lösen

- 1: 600 Nm: Der Schlagschrauber wendet das maximale Dauerdrehmoment (freies Herausdrehen) an
- 2: 600 Nm - Autostop: Der Schlagschrauber wendet bis zur vollständigen Lösung der Mutter das maximale Drehmoment an und stoppt dann automatisch (Einzelimpuls-Lösen)

Lieferung im praktischen Hartschalenkoffer mit 2 Lithium-Ionen-Akkus (4 Ah) und Schnellladegerät.

VERFÜGBAR
AB MAI

3-YEAR
WARRANTY



CE

1984/K600

€ 735,00 1 019840060

490x370x125 mm - 6,3 kg

1984 20V/600BMC

20-V-Impuls-Schlagschrauber BRUSHLESS mit 1/2-Zoll-Anschluss - 600Nm (Maschinenkörper)

- 3 verschiedene Drehmoment- und Drehzahlstellungen beim Eindrehen
- Bis zu 600 Nm maximales Drehmoment beim Ausdrehen
- Digitaler BRUSHLESS-Motor (bürstenlos)
Deutliche Leistungssteigerung, u. a.: mehr Leistung, geringerer Energieverbrauch, längere Lebensdauer des Motors, bessere Leistungsdosierung über den Druckknopf
- Außenvierkanttrieb 1/2" mit Hülsenklemmring
- Getriebekasten komplett aus Metall
- Rutschfester ergonomischer Griff
- Wählschalter Eindrehen-Ausdrehen-Sperre (für den Transport)
- Integriertes LED-Licht, um auch bei schlechten Sichtverhältnissen arbeiten zu können
- Gürtelclip links/rechts
- Geliefert im Hartschalenkoffer ohne Akkus/ohne Ladegerät

Einschrauben

3 verschiedene Drehmoment- und Drehzahlstellungen (niedrig - mittel - hoch):

- 1: 200Nm; 1000 rpm
- 2: 350Nm; 1500 rpm
- 3: 550Nm; 1800 rpm

Ausschrauben

- 1: 600 Nm: Der Schrauber arbeitet mit dem maximalen Dauerdrehmoment (freies Ausdrehen):
- 2: 600 Nm - Autostop: Der Schrauber arbeitet bis zum vollständigen Ausdrehen der Mutter mit dem maximalen Drehmoment und stoppt dann automatisch (Einzelimpuls-Ausdrehen)

VERFÜGBAR
AB MAI

3-YEAR
WARRANTY

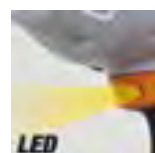

CE

1984 20V/600BMC

€ 360,00 1 019840907

490x370x125 mm - 4,4 kg

1984/K1200

18V-bürstenloser Impuls-Schlagschrauber mit Rechts- und Linkslauf, 1/2-Zoll-Anschluss - 1000 Nm

- Bürstenloser Digital-Motor
- Leistungssteigerung, wie zum Beispiel: höhere Leistung, weniger Energieverbrauch, lange Nutzzeit des Motors, verbesserte Leistungsdosierung durch Drucktaste
- Getriebekasten komplett aus Metall
- Rutschfester ergonomischer Griff
- 1/2-Zoll-Außenvierkanttrieb mit Hülsenklemmring
- Rechts-/Linksdrehung mit Sicherheitstaste (für den Transport)
- Integriertes LED-Licht, um auch bei schlechten Sichtverhältnissen arbeiten zu können
- LED-Akkuladestandsanzeige
- Gürtelclip links/rechts

Einschrauben

Auswahl von 3 verschiedenen Drehmoment- und Drehzahleinstellungen (niedrig - mittel - hoch):

- 1: 300 Nm; 900 RPM
- 2: 500 Nm; 1600 RPM
- 3: 680 Nm; 1900 RPM

Lösen

- 1: 1000 Nm: Der Schlagschrauber wendet das maximale Dauerdrehmoment (freies Herausdrehen) an
- 2: 1000 Nm - Autostop: Der Schlagschrauber wendet bis zur vollständigen Lösung der Mutter das maximale Drehmoment an und stoppt dann automatisch (Einzelimpuls-Lösen)

Lieferung im praktischen Hartschalenkoffer mit 2 Lithium-Ionen-Akkus (6 Ah) und Schnellladegerät.

1984/K1200 € 888,00 1 019840120

490x370x125 mm - 7 kg



1984 20V/1200BMC

20-V-Impuls-Schlagschrauber, BRUSHLESS mit 1/2-Zoll-Anschluss - 1200Nm (Maschinenkörper)

Ideal für Anwendungen, die ein hohes Befestigungsdrehmoment erfordern.

- 3 verschiedene Drehmoment- und Drehzahleinstellungen beim Eindrehen
- Bis zu 1200 Nm maximales Drehmoment beim Ausdrehen
- Bis zu 1700 Nm Spitzendrehmoment
- Digitaler BRUSHLESS-Motor (bürstenlos)
- Deutliche Leistungssteigerung, u. a.: mehr Leistung, geringerer Energieverbrauch, längere Lebensdauer des Motors, bessere Leistungsdosierung über den Druckknopf
- Außenvierkanttrieb 1/2" mit Hülsenklemmring
- Getriebekasten komplett aus Metall
- Rutschfester ergonomischer Griff
- Wählschalter Eindrehen-Ausdrehen-Sperre (für den Transport)
- Integriertes LED-Licht, um auch bei schlechten Sichtverhältnissen arbeiten zu können
- Gürtelclip links/rechts
- Geliefert im Hartschalenkoffer ohne Akkus/ohne Ladegerät

Einschrauben

3 verschiedene Drehmoment- und Drehzahleinstellungen (niedrig - mittel - hoch):

- 1: 350Nm; 800 rpm
- 2: 600Nm; 1400 rpm
- 3: 900Nm; 1600 rpm

Ausschrauben

- 1: 1200 Nm: Der Schrauber arbeitet mit dem maximalen Dauerdrehmoment (freies Ausdrehen)
- 2: 1200 Nm - Autostop: Der Schrauber arbeitet bis zum vollständigen Ausdrehen der Mutter mit dem maximalen Drehmoment und stoppt dann automatisch (Einzelimpuls-Ausdrehen)

1984 20V/1200BMC € 419,00 1 019840911

490x370x125 mm - 4,7 kg

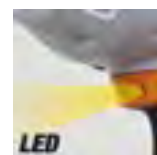

1986/K20V-125

Set mit 20-V-Winkelschleifer BRUSHLESS

Digitaler BRUSHLESS-Motor (bürstenlos)

Deutliche Leistungssteigerung, u. a.: mehr Leistung, geringerer Energieverbrauch, längere Lebensdauer des Motors, bessere Leistungsdosierung über den Druckknopf

Hauptmerkmale

- Schutz gegen unbeabsichtigten Neustart
- Zusätzlicher Handgriff, beidseitig positionierbar
- Scheibenabdeckung mit "Tool-less"-System (Schnellentriegelung)
- Wellensperrvorrichtung für ein schnelles Wechseln der Schleifscheiben
- Schlitteneinschalter mit Sperre
- Lüftungsschlitze für eine optimale Kühlung gegen das Eindringen von Staub geschützt
- Geliefert im Hartschalenkoffer mit 2 4Ah-Lithium-Ion-Akkus und Schnellladegerät

Technische Daten

- Durchmesser Schleifscheibe (im Lieferumfang nicht enthalten): 125/115 mm
- Drehzahl im Leerlauf: 8.000 U/min
- Bohrfutteraufnahme: M14
- Länge verwicklungssicheres Kabel: 4 m



1986/K20V-125

€ 638,00 1 019860015

490x370x125 mm - 5,6 kg

1986/20V-125BMC

20-V-Winkelschleifer BRUSHLESS (Maschinenkörper)

Digitaler BRUSHLESS-Motor (bürstenlos)

Deutliche Leistungssteigerung, u. a.: mehr Leistung, geringerer Energieverbrauch, längere Lebensdauer des Motors, bessere Leistungsdosierung über den Druckknopf

Hauptmerkmale

- Schutz gegen unbeabsichtigten Neustart
- Zusätzlicher Handgriff, beidseitig positionierbar
- Scheibenabdeckung mit "Tool-less"-System (Schnellentriegelung)
- Wellensperrvorrichtung für ein schnelles Wechseln der Schleifscheiben
- Schlitteneinschalter mit Sperre
- Lüftungsschlitze für eine optimale Kühlung gegen das Eindringen von Staub geschützt
- Geliefert im Hartschalenkoffer ohne Akkus/ohne Ladegerät

Technische Daten

- Durchmesser Schleifscheibe (im Lieferumfang nicht enthalten): 125/115 mm
- Drehzahl im Leerlauf: 8.000 U/min
- Bohrfutteraufnahme: M14
- Länge verwicklungssicheres Kabel: 4 m



1986/20V-125BMC

€ 263,00 1 019860025

490x370x125 mm - 3,8 kg



1994B 20V-2AH

2Ah Lithium-Ion-Akku für 20-V-Werkzeuge

Hochwertige Lithium-Ionen-Technologie

Mit Taste und 3 farbigen LEDs zur Kontrolle des Ladezustands

Hauptmerkmale

- Akkuspannung 20 V
- Akkukapazität 2A h
- Energiekapazität 40 Wh
- Akku-Typ Li-Ion

📏 410 g



VERFÜGBAR
AB MAI

CE

1994B 20V-2AH € 74,00 1 019940022

1994B 20V-4AH

4Ah Lithium-Ion-Akku für 20-V-Werkzeuge

Hochwertige Lithium-Ionen-Technologie

Mit Taste und 3 farbigen LEDs zur Kontrolle des Ladezustands

Hauptmerkmale

- Akkuspannung 20V
- Akkukapazität 4Ah
- Energiekapazität 80Wh
- Akku-Typ Li-Ion

📏 660 g



VERFÜGBAR
AB MAI

CE

1994B 20V-4AH € 124,00 1 019940044

1994B 20V-6AH

6Ah Lithium-Ion-Akku für 20-V-Werkzeuge

Hochwertige Lithium-Ionen-Technologie

Mit Taste und 3 farbigen LEDs zur Kontrolle des Ladezustands

Hauptmerkmale

- Akkuspannung 20V
- Akkukapazität 6Ah
- Energiekapazität 120Wh
- Akku-Typ Li-Ion

📏 900 g



VERFÜGBAR
AB MAI

CE

1994B 20V-6AH € 170,00 1 019940066

1994C 20V

Schnell-Ladegerät 20V 110V - 240V

Hauptmerkmale:

- LED-Akkuladestandsanzeige
- Nominale Eingangsspannung: 110V-240V ~ 50/60Hz
- Ausgangsspannung: 20V
- Ladestrom: 6A
- Nominale Eingangsleistung: 145W

Akku-Aufladezeit 20 V - 2Ah: 45 min

Akku-Aufladezeit 20 V - 4Ah: 90 min

Akku-Aufladezeit 20 V - 6Ah: 120 min

📏 570 g



VERFÜGBAR
AB MAI

CE

1994C 20V € 130,00 1 019940140

1989RCB

Baustellenradio 20 V

CE

Multifunktionales Audio-Entertainment: Digitalradio (DAB; Bluetooth) und herkömmliches FM

Geeignet für den Einsatz auf der Baustelle oder für Freizeitaktivitäten

Robustes Radio mit kompaktem, modernem Design und Schutzart IP54
Starker Stereoklang dank zweier leistungsstarker 16-W-Seitenlautsprecher

Integrierte Alarm-/Weckfunktion

Mit Tragegriff und stoßfesten Eckschützern

AUX-Anschluss und geschützter USB-Anschluss zum Anschließen und Aufladen eines Telefons

Kann mit 20-V-Beta-Batterien (optional) oder mit dem mitgelieferten Netzkabel gespeist werden.

Hauptmerkmale:

- FM-Funkfrequenzbereich: 87,5 - 108 MHz
- DAB-Radio-Frequenzbereich: 174 - 240 MHz
- Anzahl der speicherbaren FM- und DAB-Sender: 20
- Lautsprecherleistung: 16 W
- Nennspannung der Batterie (optional): 20 V
- Abmessungen des Radios: 180 x 205 x 305 mm
- Gewicht des Radios (ohne Batterie): 3,2 kg

VERFÜGBAR
AB MAI

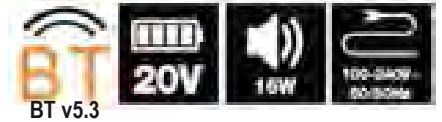

1989RCB

€ 380,00 1 019890020

C9PT

Tasche aus technischem Gewebe für Akku-Werkzeuge

Perfekt für den bequemen Transport von Beta-Elektrowerkzeugen

Aus hochfestem technischem Gewebe

Doppelter Griff für einen ausgewogenen und sicheren Halt

VERFÜGBAR
AB MAI



C9PT

€ 48,00 1 021090001

400x210x290 mm - 2,4 kg

Beta

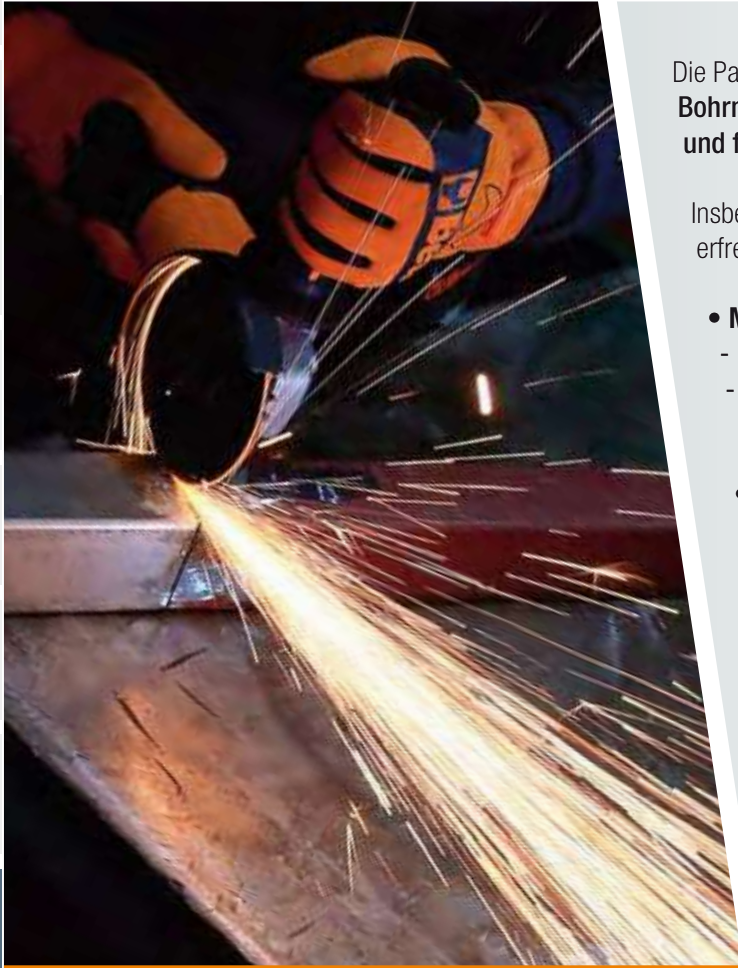

Die Palette der kabelgebundenen Werkzeuge umfasst **Winkelschleifer, Bohrmaschinen (Bohrschrauber und Bohrhammer), Sauger für feste und flüssige Stoffe, Heißluftpistolen und Heißklebepistolen.**

Insbesondere die Winkelschleifer von Beta (750 W bis 2400 W Leistung) erfreuen sich aufgrund folgender Merkmale immer größerer Beliebtheit:

• **Maximale Leistungen:**

- Leistungsstarker, verschleißfester und langlebiger gehärteter Motor
- Lüftungsschlitze für optimale Kühlung, gegen das Eindringen von Staub geschützt

• **Höchste Bediener-sicherheit:**

- Wellensicherung für schnellen Scheibenwechsel
- Schutz vor unbeabsichtigtem Neustart
- Softstart mit Anlaufbegrenzung

• **Höchster Komfort und maximale Handlichkeit:**

- Rutschfester, ergonomischer Griff für besseres Greifen
- Abgewinkelter Kopf für Arbeiten in engen Räumen

Ganze **4 Meter verwicklungsfreies Kabel** für einen komfortablen Bewegungsspielraum
Zusätzlicher Griff, beidseitig anbringbar

1956 115-750W

Winkelschleifer für Schleifscheiben Ø 115 mm

Ideal für Schneid-, Schleif- und Schrupperarbeiten

Leistungsstarker Motor 750 W
Rutschfester ergonomischer Griff für verbesserten Komfort und höhere Sicherheit
Flachkopf zum Arbeiten auf engem Raum
Äußerst leicht, mit nur 1,8 kg Gewicht

Haupteigenschaften

- Schutz gegen unbeabsichtigten Neustart
- Zusätzlicher Handgriff, beidseitig positionierbar
- Scheibenabdeckung mit "Tool-less"-System (Schnellentriegelung)
- Wellensperrvorrichtung für ein schnelles Wechseln der Schleifscheiben
- Schlitteneinschalter mit Sperre
- Lüftungsschlitze für eine optimale Kühlung, gegen das Eindringen von Staub geschützt
- Serviceschlüssel mitgeliefert

1,8 kg



1956 115-750W

€ 91,00 1 019560011

1956 125-1400W

Winkelschleifer für Schleifscheiben Ø 125 mm

Ideal für Schneid-, Schleif- und Schrubarbeiten

Leistungsstarker Motor 1400 W - Verstellbare Geschwindigkeit
Rutschfester ergonomischer Griff für verbesserten Komfort und höhere Sicherheit
Flachkopf zum Arbeiten auf engem Raum

Haupteigenschaften

- Schutz gegen unbeabsichtigten Neustart
- Zusätzlicher Antivibrations-Handgriff, beidseitig positionierbar
- Scheibenabdeckung mit "Tool-less"-System (Schnellentriegelung)
- Wellensperrvorrichtung für ein schnelles Wechseln der Schleifscheiben
- Schlitteneinschalter mit Sperre
- Lüftungsschlitze für eine optimale Kühlung, gegen das Eindringen von Staub geschützt
- Serviceschlüssel mitgeliefert

📦 2,5 kg

CE

L = 4 m



1956 125-1400W

€ 177,00 1 019560125

1956 230-2400W

Winkelschleifer für Schleifscheiben Ø 230 mm

Ideal für schwierige Schneid-, Schleif- und Schrubarbeiten

Leistungsstarker Motor 2400 W
Rutschfester ergonomischer Griff für verbesserten Komfort und höhere Sicherheit

Haupteigenschaften

- Schutz gegen unbeabsichtigten Neustart
- Sanftanlauf mit Anlaufstrombegrenzung
- Zusätzlicher Antivibrations-Handgriff, beidseitig positionierbar
- Scheibenabdeckung mit Schraubverriegelungssystem
- Wellensperrvorrichtung für ein schnelles Wechseln der Schleifscheiben
- Schlitteneinschalter mit Sperre
- Lüftungsschlitze für eine optimale Kühlung, gegen das Eindringen von Staub geschützt
- Serviceschlüssel mitgeliefert

📦 5,8 kg

CE

L = 4 m



1956 230-2400W

€ 238,00 1 019560230

1966/910W

Schlagbohrmaschine 910W

Ideal zum Bohren verschiedener Materialien wie Holz, Metall, Kunststoff, Mauerwerk und Beton

Leistungsstarker Motor 910 W

Schlankes, kompaktes Design mit rutschfestem, ergonomischem Griff

Selbstspannendes Bohrfutter, 13 mm, aus Metall

Variable Geschwindigkeit mit Reversibilität

Ganzmetall-Getriebegehäuse

Schaltersperre für mehr Bedienkomfort

Hauptmerkmale:

- Max. Bohrdurchmesser Holz 32 mm
- Max. Bohrdurchmesser Metall 13 mm
- Max. Bohrdurchmesser Mauerwerk 13 mm
- Leerlaufdrehzahl 0-2800 U/min
- 4 m langes, verwicklungsfreies Stromkabel

Im Lieferumfang:

- Selbstspannendes Bohrfutter, 13 mm, aus Metall
- Zusätzlicher, um 360° schwenkbarer Seitengriff
- Tiefenanschlag

VERFÜGBAR
AB MAI



CE

1966/910W

€ 146,00

1

019660091

420x320x120 mm - 4,3 kg

1967/800W

Bohrhammer SDS-PLUS 800 W

Ideal zum Bohren, Dübeln und Meißeln in Mauerwerk, Beton, Fliesen, Holz und Metall

Leistungsstarker 800-W-Motor für härteste Einsätze

Professionell, leicht und leistungsstark

Ergonomisches und kompaktes Design für Arbeiten in engen Räumen

Hauptmerkmale

3 Betriebsarten + Vario-Lock-Funktion:

- Bohrfunktion
- Hammerfunktion
- Meißelfunktion
- Vario-Lock-Funktion: zur Auswahl von 36 Meißelpositionen und zum Erreichen des optimalen Arbeitswinkels

- Max. Bohrdurchmesser Holz 32 mm
- Max. Bohrdurchmesser Metall 13 mm
- Max. Bohrdurchmesser Mauerwerk 26 mm

Umkehrbar

Sicherheitskupplung

Schlagenergie 3,2J

Lehrlaufdrehzahl 0-1350 U/min

Schlagzahl 0-5700 Schläge/min

4 m langes, verwicklungsfreies Stromkabel

Im Lieferumfang:

- 13-mm-Spannfutter mit SDS-PLUS-Aufnahme
- Zusätzlicher, um 360° schwenkbarer Seitengriff
- Tiefenanschlag
- 3 Wandbohrer Ø 8-10-12 mm, Länge 150 mm
- 1 Flachmeißel 14x250 mm
- 1 Spitzmeißel 14x250 mm

VERFÜGBAR
AB MAI



CE

1967/800W

€ 209,00

1

019670080

420x300x115 mm - 5,2 kg



1850D

Heißluftfön, 3-stufig

- Pos. I 250 l/min 50 °C
- Pos. II 250 l/min 400 °C
- Pos. III 500 l/min 550 °C



1850D	L mm 255	H mm 210	€ 155,00	1	018500018
-------	----------------	----------------	-------------	---	-----------

1850E

Heißluftfön mit elektronischer Regulierung

- Pos. I 250-500 l/min 50 °C
- Pos. II 250-500 l/min 50-650 °C

- Digitales Display.
- Druckknöpfe zur Temperatur- und Luftdurchflussregulierung.
- 4 ursprünglich gespeicherte Programme; kundenspezifisch anpassbare Programme einstellbar

- Prog 1 150 °C ca. 400 l/min
- Prog 2 200 °C ca. 400 l/min
- Prog 3 300 °C ca. 450 l/min
- Prog 4 400 °C ca. 500 l/min



1850E	L mm 255	H mm 210	€ 323,00	1	018500020
-------	----------------	----------------	-------------	---	-----------

1851VK

Klebspistole für Heißkleber mit Schmelzklebestoff in 12 Sticks im Koffer

- Leistung: 80 Watt
- Für Schmelzklebestoff in Sticks ø 11 mm und 12 mm

CE



1851VK	€ 64,00	1	018510058
320x250x50 mm			

1851VK-12C

Schmelzklebestoff in 12 Sticks ø 11 mm



1851VK-12C	€ 16,40	1	018510062
------------	------------	---	-----------

1851VK-12V

Schmelzklebestoff in 12 Sticks, für lackierte Oberflächen ø 11 mm



1851VK-12V	€ 16,40	1	018510072
------------	------------	---	-----------



1870

Staubsauger für Feststoffe und Flüssigkeiten, 20 l

- Bypass-Motor, einstufig
- Spannung: 220/240 V
- Frequenz: 50/60 Hz
- Max. Leistung: 1200 W
- Luftmenge: 58 l / sek.
- Max. Saugdruck: 190 mbar
- Max. Trommelkapazität: 20 l, hergestellt aus antistatischem PP
- Schallemission: <70 dB(A)
- Kabellänge: 5 m
- Zubehörmagazin
- STANDARDZUBEHÖR, ø 36 mm
- 1 gewellter Schlauch mit ergonomischem Griff
- 2 feste Verlängerungsrohre
- 1 Multifunktionsbürste für Böden und Flüssigkeiten
- 1 Flachdüse
- FILTERSYSTEME
- 1 Luftfilterkartusche 1900 cm² - 12 µm, Nennwert
- 1 Antischaumfilter PPI 45/PPI 30

CE



IPX4

1870	€ 275,00	1	018700020
------	-------------	---	-----------

1870I

Staubsauger für Feststoffe und Flüssigkeiten, 20 l, Trommel aus Edelstahl

- Bypass-Motor, einstufig
- Spannung: 220/240 V
- Frequenz: 50/60 Hz
- Max. Leistung: 1200 W
- Luftmenge: 58 l/Sek.
- Max. Saugdruck: 190 mbar
- Max. Trommelkapazität: 20 l, hergestellt aus Edelstahl
- Schallemission: <70 dB(A)
- Kabellänge: 5 m
- IM LIEFERUNG ENTHALTENES ZUBEHÖR ø 36 mm
- 1 gewellter Schlauch mit ergonomischem Griff mit Entlüftung
- 2 feste Verlängerungsrohre
- 1 Multifunktionsbürste für Böden und Flüssigkeiten
- 1 Flachdüse
- 1 Papierbeutel
- FILTERSYSTEME
- 1 Luftfilterkartusche 1900 cm² - 12 µm Nennwert
- 1 Antischaumfilter PPI 45/PPI 30

CE



IPX4

1870I	€ 306,00	1	018700020
-------	-------------	---	-----------

1872L

Nass-Trockensauger, 35 l
Zertifizierte Klasse "L"

- Bypass-Motor, zweistufig
 - Spannung 220/240 V
 - Frequenz 50/60 Hz
 - Max. Leistung 1100 W
 - Luftdurchfluss 55 l/sec.
 - Max. Unterdruck 220 mbar
 - Max. Fassungsvermögen Kanne 35 l, aus antistatischem PE-HD
 - Akustische Emission <70 dB(A)
 - Kabellänge 6 m
- IM LIEFERUMFANG ENTHALTENES ZUBEHÖR Ø 36 mm
- 1 Wellrohr mit ergonomischem Griff
 - 2 Verlängerungsrohre aus Kunststoff
 - 1 Kombi-Bürstenrahmen
 - 1 Einsatz mit Flüssigkeitssammlern aus Gummi
 - 1 Strahlmündstück
- FILTERSYSTEME
- 1 Faservlies-Filterbeutel, Filtrationsklasse "L"
 - 1 Filterkartusche klassifiziert IFA Klasse "L"
 - 1 Antischaumfilter PPI 45/PPI 30
 - 2 Nachfilter aus PP-laminiertem PET

CE



IPX4

1872L 35 € 601,00 1 018720135

1873

Staubsauger für Feststoffe und Flüssigkeiten,
30 l, hergestellt aus Edelstahl

- Bypass-Motor, zweistufig • Spannung: 220/240 V
 - Frequenz: 50/60 Hz • Max. Leistung: 1100 W
 - Luftmenge: 55 l / sek. • Max. Saugdruck: 220 mbar
 - Max. Trommelkapazität: 30 l, hergestellt aus Edelstahl
 - Schallemission: <61 dB(A)
 - Kabellänge: 6 m • Zubehörwagen
- STANDARDZUBEHÖR, Ø 45 mm
- 1 gewellter Schlauch mit ergonomischem Griff
 - 2 Verlängerungsrohre aus Edelstahl
 - 1 industrieller Bürstenrahmen
 - 1 industrielle Sektion für Teppiche
 - 1 industrielle Schlauchsektion mit Flüssigkeitsauffangung
 - 1 Flachdüse
- FILTERSYSTEME
- 1 Papierfilterbeutel
 - 1 Luftfilterkartusche 1900 cm² 12 µm, Nennwert
 - 1 Antischaumfilter PPI 45/PPI 30

CE



1873 30 € 800,00 1 018730030

1874

Staubsauger für Feststoffe und Flüssigkeiten,
50 l, hergestellt aus Edelstahl

- Bypass-Motor, zweistufig • Spannung: 220/240 V
 - Frequenz: 50/60 Hz • Max. Leistung: 1350 W
 - Luftmenge: 55 l / sek. • Max. Saugdruck: 240 mbar
 - Max. Trommelkapazität 50 l, hergestellt aus Edelstahl
 - Schallemission: <63 dB(A) • Kabellänge: 6 m
 - Zubehörwagen
- STANDARDZUBEHÖR, Ø 45 mm
- 1 gewellter Schlauch mit ergonomischem Griff
 - 2 Verlängerungsrohre aus Edelstahl
 - 1 industrieller Bürstenrahmen
 - 1 industrielle Sektion für Teppiche
 - 1 industrielle Schlauchsektion mit Flüssigkeitsauffangung
 - 1 Flachdüse
- FILTERSYSTEME
- 1 Papierfilterbeutel
 - 1 Luftfilterkartusche 5200 cm², 12 µm, Nennwert
 - 1 Antischaumfilter PPI 45/PPI 30

CE



1874 50 € 1.010,00 1 018740050

1870-20/5S

5 horizontale Papierbeutel für Art.
1870-1870I-1875LT



1870 20/5S € 62,50 1 018700021

1870-72 /FC

Kartuschenfilter 1900 cm² 12 µm, Nennwert,
für Artikel 1870 - 1870I - 1873 - 1875LT



1870/FC € 53,50 1 018700026

1870-72/FL

Filter für Flüssigkeitsabsauger
Art. 1870 - 1870I - 1872L - 1873 - 1874 -
1875LT



1870 72/FL € 19,80 1 018700027

1872L 35/FC

Filterkartusche Klasse "L"
für Art. 1872L



1872L 35/FC € 64,50 1 018720144

1872L 35/5S

5 Faservlies-Filterbeutel, Filtrationsklasse "L"
für Art. 1872L- 1873



1872L 35/5S € 98,50 1 018720136

1873-30/5S

5 vertikale Papierbeutel für Art. 1873



1873 30/5S € 62,50 1 018730031

1874-50/5S

5 vertikale Beutel für Art. 1874



1874 50/5S € 79,00 1 018740051

1874-50/FC

Kartuschenfilter 5200 cm² 12 µm, Nennwert.
für Art. 1874



1874 50/FC € 64,00 1 018740056



DRUCKLUFTWERKZEUGE UND ZUBEHÖR

Seit mehr als 20 Jahre hat das Unternehmen Beta Utensili sein Angebot mit einer kompletten Produktreihe von Druckluftwerkzeugen und Zubehör für die Automotive Branche und die Industriewartung bereichert: Schlagschrauber, Ratschenschrauber, Bohrmaschinen, Schleifer Poliermaschinen und viele andere Artikel.

In all dieser Zeit war die enge Zusammenarbeit mit den professionellen Nutzern unserer Produkte grundlegend, um ein ständiges Wachstum zu garantieren. Es ist dank dieses Wachstums, dass der Markt heute den Beta Druckluftwerkzeugen ein optimales Verhältnis Zuverlässigkeit/Leistungen zuerkennt.



























Um die Anforderungen des Marktes optimal erfüllen zu können, führt Beta Utensili innerhalb seiner Qualitätsabteilungen die Reparaturen der Druckluftartikel durch. Dieser Prozess hat dem Unternehmen ermöglicht, sein Know-how bedeutend zu steigern und die Anfragen der Kunden prompt abzuwickeln.





www.beta-tools.com

HINWEISE FÜR DIE WAHL DER DRUCKLUFTWERKZEUGE













SCHLAGSCHRAUBER

■	BETA-NR.	N °	MATERIAL	 max. Nm	 db (A) LpA	 db (A) LpW	 l/min.	 kg	MECHANISMUS	 m/s²
3/8"		1924F	Aluminium	108	93,6	104,6	59	0,5	Doppelschlag	6,85
3/8"		1924B	Aluminium	353	91	95	80	1,5	Pin clutch	7,9
3/8"		1924CD	Verbundwerkstoff	410	91,7	102,7	79	1,3	Doppelschlag	6,2
3/8"		1924XM	Verbundwerkstoff	515	91,7	102,7	122	1,3	Einzelschlag	6,2
1/2"		1927AN	Aluminium	244	89,4	100,4	190	2,1	Einzelschlag	8,63
1/2"		1927G	Aluminium	325	92,2	103,2	113	1,2	Einzelschlag	9,96
1/2"		1927B	Aluminium	705	98,0	109,0	133	2,1	Pin clutch	14,08
1/2"		1927XM	Aluminium	770	102	113	122	1,3	Einzelschlag	7,5
1/2"		1927CD	Verbundwerkstoff	1.020	95,5	106,5	130	2,3	Doppelschlag	7,2
1/2"		1927P	Verbundwerkstoff	1.750	95,1	106,1	290	2,0	Doppelschlag	6,7
3/4"		1928XM	Aluminium	1.600	91,8	102,8	175	2,9	Doppelschlag	12,96
3/4"		1928DA	Aluminium	1.695	96	99,5	300	4,3	Doppelschlag	3,6
3/4"		1928DAL	Aluminium	1.695	96	99,5	300	4,8	Doppelschlag	3,6
3/4"		1928CD	Verbundwerkstoff	1.800	97,5	108,5	215	3,5	Doppelschlag	11,4
3/4"		1928P	Verbundwerkstoff	2.100	96,2	107,2	221	3,7	Doppelschlag	7,6
1"		1930CD	Verbundwerkstoff	2.445	95,6	97,1	410	7,1	Doppelschlag	3,6
1"		1930PA	Aluminium	2.445	96,0	97,1	410	9,6	Doppelschlag	7,2
1"		1930A	Aluminium	2.445	103,3	114,3	460	9,5	Doppelschlag	67
1"		1930LH	Aluminium	2.441	97,1	108,1	282	7,1	Doppelschlag	17,4
1"		1930LA	Aluminium	2.445	95,6	97,1	460	10,6	Doppelschlag	3,6

HINWEISE FÜR DIE WAHL DER DRUCKLUFTWERKZEUGE

■	BETA ITEM	N°	MATERIAL	max. Nm	db (A) LpA	db (A) LpW	l/min.	kg	MECHANISM	m/s ²
1"		1930HLA	Aluminium	3.661	99	101	460	16,4	Doppelschlag	16,4
1 1/2"		1930ZL	Aluminium	4.068	102,4	113,4	480	15	Doppelschlag	69.6

RATSCHENSCHRAUBER/UMSCHALTKNARREN

■	BETA ITEM	N°	 max. Nm	 db (A) LpA	 db (A) LpW	 l/min.	 kg	 m/s ²
1/4"		1921B1	24	96	85	90	0,4	2.6
1/4"		1921M1	27	84	88	96	0,6	1.8
1/4"		1922P1	68	90,6	101,6	88	0,6	8.61
3/8"		1921M2	27	84	88	96	0,6	1.8
3/8"		1922P2	68	90,6	101,6	88	0,6	8.61
1/2"		1921N3	68	80	87	140	1,2	2.6
1/2"		1922P3	136	94,9	105,9	113	1,5	18.28

EINHANDSTABSCHLEIFER

	BETA ITEM	N°	POWER	 db (A) LpA	 db (A) LpW	 l/min.	 kg	 m/s ²
		1933	0,20 kW	80,0	87,0	230	0,38	4,53
		1933L	0,20 kW	80,0	87,0	270	0,67	1,15
		1933AN90	0,20 kW	80,0	87,0	230	0,51	1,24
		1933I	0,38 kW	80,0	87,0	260	0,67	4,53
		1933IL	0,38 kW	79,0	97,0	113	1,4	1,6
		1933IH	0,75 kW	88,1	99,1	370	0,8	2,6
		1933ILH	0,75 kW	85,7	96,7	370	1,2	1,4
		1933AN90-H	0,75 kW	85,6	96,6	370	1,1	6,7
		1934MAV	0,04 kW	71	76	115	0,2	2,5
		1934MAV70	0,08 kW	80	87	115	0,2	4

1921B1 Baby-Ratschenschrauber

1/4"

CE



Drehzahl im Leerlauf	350 U/min
Max. Drehmoment	24 Nm
Bolzen-Ø	CI 8.8 M7 ● 11 mm
Bolzen-Ø	CI 12.9 M6 ● 10 mm
Luftanschluss	1/4" GAS
Betriebsdruck	6,2 bar
Innen-Ø Luftschlauch	8 mm
Durchschnittlicher Luftverbrauch	68 l/min
Gewicht	0,4 kg

■	kg	€	🔧	📄
1/4		290,00	1	019210001

1921M1 Ratschenschrauber, kompakte Ausführung

• Geschwindigkeitsregelung durch einen Drehgriff

1/4"

CE



Drehzahl im Leerlauf	200 U/min
Max. Drehmoment	27 Nm
Bolzen-Ø	CI 8.8 M7 ● 11 mm
Bolzen-Ø	CI 12.9 M6 ● 10 mm
Luftanschluss	1/4" GAS
Betriebsdruck	6,2 bar
Innen-Ø Luftschlauch	8 mm
Durchschnittlicher Luftverbrauch	96 l/min
Gewicht	0,6 kg

■	kg	€	🔧	📄
1/4	0,6	256,00	1	019210005

1921M2 Ratschenschrauber, kompakte Ausführung

• Geschwindigkeitsregelung durch einen Drehgriff

3/8"

CE



Drehzahl im Leerlauf	200 U/min
Max. Drehmoment	27 Nm
Bolzen-Ø	CI 8.8 M7 ● 11 mm
Bolzen-Ø	CI 12.9 M6 ● 10 mm
Luftanschluss	1/4" GAS
Betriebsdruck	6,2 bar
Innen-Ø Luftschlauch	8 mm
Durchschnittlicher Luftverbrauch	96 l/min
Gewicht	0,6 kg

■	kg	€	🔧	📄
3/8	0,6	256,00	1	019210015

1921N3 Ratschenschrauber

• Geschwindigkeitsregelung durch einen Drehgriff

1/2"

CE



Drehzahl im Leerlauf	150 U/min
Max. Drehmoment	68 Nm
Bolzen-Ø	CI 8.8 M10 ● 16 mm
Bolzen-Ø	CI 12.9 M8 ● 13 mm
Luftanschluss	1/4" GAS
Betriebsdruck	6,2 bar
Innen-Ø Luftschlauch	10 mm
Durchschnittlicher Luftverbrauch	140 l/min
Gewicht	1,2 kg

■	kg	€	🔧	📄
1/2	1,2	256,00	1	019210025

1922P1 Schlag Umschaltknarre

• "Rocking dog" Schlagmechanismus mit doppeltem Hammer-Schlagwerk

1/4"

CE



Drehzahl im Leerlauf	700 U/min
Max. Drehmoment	68 Nm
Bolzen-Ø	CI 8.8 M10 ● 16 mm
Bolzen-Ø	CI 12.9 M8 ● 13 mm
Luftanschluss	1/4" GAS
Betriebsdruck	6,2 bar
Innen-Ø Luftschlauch	10 mm
Durchschnittlicher Luftverbrauch	88 l/min
Gewicht	0,6 kg

■	kg	€	🔧	📄
1/4	0,6	310,00	1	019220006

1922P2 Schlag Umschaltknarre

• "Rocking dog" Schlagmechanismus mit doppeltem Hammer-Schlagwerk

3/8"

CE



Drehzahl im Leerlauf	700 U/min
Max. Drehmoment	68 Nm
Bolzen-Ø	CI 8.8 M10 ● 16 mm
Bolzen-Ø	CI 12.9 M8 ● 13 mm
Luftanschluss	1/4" GAS
Betriebsdruck	6,2 bar
Innen-Ø Luftschlauch	10 mm
Durchschnittlicher Luftverbrauch	88 l/min
Gewicht	0,6 kg

■	kg	€	🔧	📄
3/8	0,6	310,00	1	019220010

1922P3 Schlag Umschaltknarre

• "Rocking dog" Schlagmechanismus mit doppeltem Hammer-Schlagwerk

1/2"

CE



Drehzahl im Leerlauf	600 U/min
Max. Drehmoment	136 Nm
Bolzen-Ø	CI 8.8 M12 ● 18 mm
Bolzen-Ø	CI 12.9 M10 ● 16 mm
Luftanschluss	1/4" GAS
Betriebsdruck	6,2 bar
Innen-Ø Luftschlauch	10 mm
Durchschnittlicher Luftverbrauch	113 l/min
Gewicht	1,5 kg

■	kg	€	🔧	📄
1/2	1,5	489,00	1	019220013

1924F Kompakter Schlagschrauber "Butterfly" mit Rechts-/ Linkslauf

• "Rocking dog" Schlagmechanismus mit doppeltem Hammer-Schlagwerk

3/8"

CE



Drehzahl im Leerlauf	12.000 U/min
Max. Drehmoment	108 Nm
Bolzen-Ø	CI 8.8 M12 ● 18 mm
Bolzen-Ø	CI 12.9 M10 ● 16 mm
Luftanschluss	1/4" GAS
Betriebsdruck	6,2 bar
Innen-Ø Luftschlauch	10 mm
Durchschnittlicher Luftverbrauch	59 l/min
Gewicht	0,5 kg

■	kg	€	🔧	📄
3/8	0,5	286,00	1	019240025



1924B

Schlagschrauber mit Rechts- und Linkslauf, kompakte Ausführung

• Schlagmechanismus "Pin Clutch"



Drehzahl im Leerlauf	10.000 U/min
Max. Drehmoment	353 Nm
Bolzen-Ø	CI 8.8 M16●24 mm
Bolzen-Ø	CI 12.9 M14●21 mm
Luftanschluss	1/4" GAS
Betriebsdruck	6,2 bar
Innen-Ø Luftschnlauch	8 mm
Durchschnittlicher Luftverbrauch	80 l/min
Gewicht	1,5 kg

3/8"	1,5 kg	€ 328,00	1	019240021
------	--------	----------	---	-----------

1924XM

Kompakter, umschaltbarer Schlagschrauber

• Einfacher Schlagmechanismus



Drehzahl im Leerlauf	9.000 U/min
Max. Drehmoment	515 Nm
Bolzen-Ø	CI 8.8 M16●24 mm
Bolzen-Ø	CI 12.9 M14●21 mm
Luftanschluss	1/4" GAS
Betriebsdruck	6,2 bar
Innen-Ø Luftschnlauch	10 mm
Durchschnittlicher Luftverbrauch	122 l/min
Gewicht	1,3 kg

3/8"	1,3 kg	€ 317,00	1	019240030
------	--------	----------	---	-----------

1927B

Schlagschrauber mit Rechts-/Linkslauf

• Schlagmechanismus "Pin Clutch"



Drehzahl im Leerlauf	7.000 U/min
Max. Drehmoment	705 Nm
Bolzen-Ø	CI 8.8 M22●34 mm
Bolzen-Ø	CI 12.9 M18●27 mm
Luftanschluss	1/4" GAS
Betriebsdruck	6,2 bar
Innen-Ø Luftschnlauch	10 mm
Durchschnittlicher Luftverbrauch	133 l/min
Gewicht	2,1 kg

1/2"	2,1 kg	€ 221,00	1	019270022
------	--------	----------	---	-----------

1924CD

Schlagschrauber mit Rechts- und Linkslauf aus Verbundwerkstoff

• Doppelter Schlagmechanismus



Drehzahl im Leerlauf	10.000 U/min
Max. Drehmoment	410 Nm
Bolzen-Ø	CI 8.8 M16●24 mm
Bolzen-Ø	CI 12.9 M14●21 mm
Luftanschluss	1/4" GAS
Betriebsdruck	6,2 bar
Innen-Ø Luftschnlauch	8 mm
Durchschnittlicher Luftverbrauch	79 l/min
Gewicht	1,3 kg

3/8"	1,3 kg	€ 398,00	1	019240007
------	--------	----------	---	-----------



1927B/K5

Umschaltbarer Schlagschrauber aus Aluminium, mit 5 Kraftsteckschlüsseln, im Koffer



Drehzahl im Leerlauf	7.000 U/min
Max. Drehmoment	705 Nm
Bolzen-Ø	CI 8.8 M22●34 mm
Bolzen-Ø	CI 12.9 M18●27 mm
Luftanschluss	1/4" GAS
Betriebsdruck	6,2 bar
Innen-Ø Luftschnlauch	10 mm
Durchschnittlicher Luftverbrauch	133 l/min
Gewicht	2,1 kg

1/2"	3,5 kg	€ 291,00	1	019270122
350x305x86 mm				

1927CD

Schlagschrauber mit Rechts- und Linkslauf aus Verbundwerkstoff
• Doppelter Schlagmechanismus



Drehzahl im Leerlauf	7.000 U/min
Max. Drehmoment	1.020 Nm
Bolzen-Ø	Cl 8.8 M22●34 mm
Bolzen-Ø	Cl 12.9 M18●27 mm
Luftanschluss	1/4" GAS
Betriebsdruck	6,2 bar
Innen-Ø Luftschlauch	10 mm
Durchschnittlicher Luftverbrauch	130 l/min
Gewicht	2,3 kg

1/2 2,3 € 458,00 1 019270007

1927P

Schlagschrauber mit Rechts- und Linkslauf aus Verbundwerkstoff
• Doppelter Schlagmechanismus



Drehzahl im Leerlauf	7.500 U/min
Max. Drehmoment	1.750 Nm
Bolzen-Ø	Cl 8.8 M24●36 mm
Bolzen-Ø	Cl 12.9 M20●30 mm
Luftanschluss	1/4" GAS
Betriebsdruck	6,2 bar
Innen-Ø Luftschlauch	10 mm
Durchschnittlicher Luftverbrauch	290 l/min
Gewicht	2 kg

1/2 2,0 € 499,00 1 019270008

1927XM

Kompakter, umschaltbarer Schlagschrauber
• Einzel-Hammerimpulsgerät



Drehzahl im Leerlauf	10.000 U/min
Maximales Drehmoment	770 Nm
Bolzenkapazität	Cl 8.8 M22●34 mm
Bolzenkapazität	Cl 12.9 M18●27 mm
Luftzufuhr	1/4" GAS
Betriebsdruck	6,2 bar
Luftschlauch- Innendurchmesser (Ø)	10 mm
Durchschnittlicher Luftverbrauch	122 l/min
Gewicht	1,3 kg

1/2 1,3 € 337,00 1 019270030

1927CD/K3

Sortiment bestehend aus einem Schlagschrauber mit Rechts- und Linkslauf und drei Kraftsteckschlüsseln

• Doppelter Schlagmechanismus



Drehzahl im Leerlauf	7.000 U/min
Max.-Drehmoment	1.020 Nm
Bolzen-Ø	Cl 8.8 M22●34 mm
Bolzen-Ø	Cl 12.9 M18●27 mm
Luftanschluss	1/4" GAS
Betriebsdruck	6,2 bar
Innen-Ø Luftschlauch	10 mm
Durchschnittlicher Luftverbrauch	130 l/min
Gewicht	1,9 kg

1/2 4 € 515,00 1 019270107
350x305x86 mm

1927P/K3

Schlagschrauber mit Rechts- und Linkslauf aus Verbundwerkstoff, mit 3 Kraftsteckschlüsseln geliefert



Drehzahl im Leerlauf	7.500 U/min
Max. Drehmoment	1.750 Nm
Bolzen-Æ	Cl 8.8 M24●36 mm
Bolzen-Æ	Cl 12.9 M20●30 mm
Luftanschluss	1/4" GAS
Betriebsdruck	6,2 Bar
Innen-Ø Luftschlauch	10 mm
Durchschnittlicher Luftverbrauch	290 l/min
Gewicht	2,9 kg

1/2 4 € 582,00 1 019270118
350x305x86 mm

1927XM/K5

Sortiment mit einem Schlagschrauber mit Rechts- und Linkslauf, kompakte Ausführung, und fünf Kraftsteckschlüsseln

• Einfacher Schlagmechanismus



Drehzahl im Leerlauf	10.000 U/min
Maximales Drehmoment	770 Nm
Bolzenkapazität	Cl 8.8 M22●34 mm
Bolzenkapazität	Cl 12.9 M18●27 mm
Luftanschluss	1/4" GAS
Betriebsdruck	6,2 Bar
Luftschlauch- Innendurchmesser (Ø)	10 mm
Durchschnittlicher Luftverbrauch	122 l/min
Gewicht	1,3 kg

1/2 2,8 € 410,00 1 019270129
307x206x86 mm

1927AN

Winkelschlagschrauber mit Rechts- und Linkslauf

- Einzelschlagmechanismus

1/2"

CE



Drehzahl im Leerlauf	4.700 U/min
Max. Drehmoment	244 Nm
Bolzen-Ø	CI 8.8 M14●21 mm
Bolzen-Ø	CI 12.9 M12●19 mm
Luftanschluss	1/4" GAS
Betriebsdruck	6,2 bar
Innen-Ø Luftschauch	10 mm
Durchschnittlicher Luftverbrauch	190 l/min
Gewicht	2,1 kg

1/2"	kg	€	1	019270012
	2,1	595,00		

1927G

Kompakter, umschaltbarer Schlagschrauber

- Einzelschlagmechanismus

1/2"

CE



Drehzahl im Leerlauf	8500 U/min
Max. Drehmoment	325 Nm
Bolzen-Ø	CI 8.8 M16●24 mm
Bolzen-Ø	CI 12.9 M14●21 mm
Luftanschluss	1/4" GAS
Betriebsdruck	6,2 bar
Innen-Ø Luftschauch	10 mm
Durchschnittlicher Luftverbrauch	113 l/min
Gewicht	1,2 kg

1/2"	kg	€	1	019270050
	1,2	489,00		

1927SP-AM

Magnethalter für Druckluft-Schlagschrauber

- Ausgestattet mit zwei Magneten mit hoher Haftkraft mit Schutzgummi
- Aufnahme von 1 Schlagschrauber 1/2", 4 Steckschlüsseln und 1 Drehmomentschlüssel
- Tragfähigkeit: 10 kg



g	€	1	019270000
400	72,50		

1928DA

Schlagschrauber mit Rechts- und Linkslauf

- Doppelter Schlagmechanismus

3/4"

CE



Drehzahl im Leerlauf	5.000 U/min
Max. Drehmoment	1.695 Nm
Bolzen-Ø	CI 8.8 M30●46 mm
Bolzen-Ø	CI 12.9 M27●41 mm
Luftanschluss	3/8" GAS
Betriebsdruck	6,2 bar
Innen-Ø Luftschauch	10 mm
Durchschnittlicher Luftverbrauch	240 l/min
Gewicht	4,3 kg

3/4"	kg	€	1	019280022
	4,3	966,00		

1928DAL

Schlagschrauber mit Rechts- und Linkslauf

- Doppelter Schlagmechanismus

3/4"

CE



Drehzahl im Leerlauf	5.000 U/min
Max. Drehmoment	1.695 Nm
Bolzen-Ø	CI 8.8 M27●41 mm
Bolzen-Ø	CI 12.9 M24●36 mm
Luftanschluss	3/8" GAS
Betriebsdruck	6,2 bar
Innen-Ø Luftschauch	10 mm
Durchschnittlicher Luftverbrauch	240 l/min
Gewicht	4,8 kg

3/4"	kg	€	1	019280023
	4,8	1.036,00		

1928K4

Sortiment mit einem Schlagschrauber mit Rechts- und Linkslauf und vier Kraftsteckschlüsseln, lange Ausführung

- Schlagmechanismus "Pin Clutch"

3/4"

CE



728L 27-30-32-36 mm

Drehzahl im Leerlauf	4.000 U/min
Max. Drehmoment	1.493 Nm
Bolzen-Ø	CI 8.8 M27●41 mm
Bolzen-Ø	CI 12.9 M24●36 mm
Luftanschluss	3/8" GAS BSP
Betriebsdruck	6,2 bar
Innen-Ø Luftschauch	10 mm
Durchschnittlicher Luftverbrauch	260 l/min
Gewicht Schlagschrauber	5,2 kg

3/4"	kg	€	1	019280104
	9,3	986,00		
410x330x106 mm				

1928XM

Kompakter, umschaltbarer Schlagschrauber

- Doppelter Schlagmechanismus
- Sehr kompakt und leistungsstark
- Einhändig bedienbarer Umschaltknopf
- 3 justierbare An- und Abschraubpositionen
- Abgas durch Handgriff

3/4"

CE



Drehzahl im Leerlauf	4.800 U/min
Maximales Drehmoment	1.600 Nm
Bolzen-Ø	CI 8.8 M27●41 mm
Bolzen-Ø	CI 12.9 M24●36 mm
Luftanschluss	3/8" GAS
Betriebsdruck	6,2 bar
Innen-Ø Luftschauch	10 mm
Durchschnittlicher Luftverbrauch	175 l/min
Gewicht	2,9 kg

3/4"	kg	€	1	019280030
	2,9	668,00		

1928CD

Schlagschrauber mit Rechts- und Linkslauf aus Verbundwerkstoff

- Doppelter Schlagmechanismus



Drehzahl im Leerlauf	4.500 U/min
Max. Drehmoment	1.800 Nm
Bolzen-Ø	CI 8.8 M27 ● 41 mm
Bolzen-Ø	CI 12.9 M24 ● 36 mm
Luftanschluss	3/8" GAS
Betriebsdruck	6,2 bar
Innen-Ø Luftschlauch	10 mm
Durchschnittlicher Luftverbrauch	215 l/min
Gewicht	3,5 kg

■	kg	€	🔧	📦
3/4	3,5	1.100,00	1	019280007

1928P

Schlagschrauber mit Rechts- und Linkslauf aus Verbundwerkstoff

- Doppelter Schlagmechanismus



Drehzahl im Leerlauf	5.000 U/min
Max. Drehmoment	2.100 Nm
Bolzen-Ø	CI 8.8 M30 ● 46 mm
Bolzen-Ø	CI 12.9 M27 ● 41 mm
Luftanschluss	3/8" GAS
Betriebsdruck	6,2 bar
Innen-Ø Luftschlauch	10 mm
Durchschnittlicher Luftverbrauch	221 l/min
Gewicht	3,7 kg

■	kg	€	🔧	📦
3/4	3,7	1.330,00	1	019280006

1930LH

Schlagschrauber mit Rechts-/Linkslauf

- Doppelschlagmechanismus

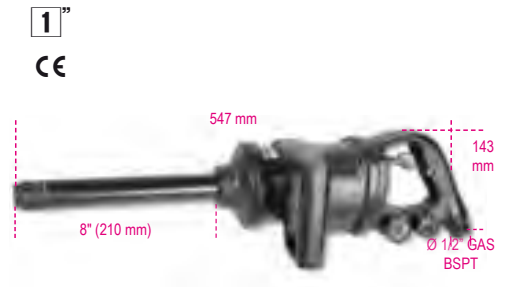

Drehzahl im Leerlauf	6.000 U/min
Max. Drehmoment	2.441 Nm
Bolzen-Ø	CI 8.8 M36 ● 55 mm
Bolzen-Ø	CI 12.9 M30 ● 46 mm
Luftanschluss	1/2" GAS
Betriebsdruck	6,2 bar
Innen-Ø Luftschlauch	13 mm
Durchschnittlicher Luftverbrauch	280 l/min
Gewicht	7,1 kg

■	kg	€	🔧	📦
1	7,1	1.490,00	1	019300030

1930CD

Schlagschrauber mit Rechts- und Linkslauf aus Verbundwerkstoff

- Doppelter Schlagmechanismus



Drehzahl im Leerlauf	4.000 U/min
Max. Drehmoment	2.445 Nm
Bolzen-Ø	CI 8.8 M36 ● 55 mm
Bolzen-Ø	CI 12.9 M30 ● 46 mm
Luftanschluss	1/2" GAS
Betriebsdruck	6,2 bar
Innen-Ø Luftschlauch	13 mm
Durchschnittlicher Luftverbrauch	320 l/min
Gewicht	7,1 kg

■	kg	€	🔧	📦
1	7,1	1.600,00	1	019300022

1930PA

Schlagschrauber mit Rechts- und Linkslauf

- Doppelter Schlagmechanismus

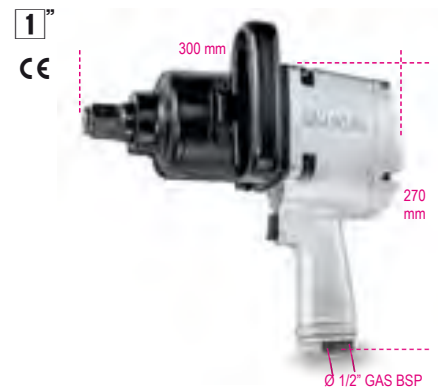

Drehzahl im Leerlauf	3.500 U/min
Max. Drehmoment	2.445 Nm
Bolzen-Ø	CI 8.8 M36 ● 55 mm
Bolzen-Ø	CI 12.9 M30 ● 46 mm
Luftanschluss	1/2" GAS
Betriebsdruck	6,2 bar
Innen-Ø Luftschlauch	13 mm
Durchschnittlicher Luftverbrauch	350 l/min
Gewicht	9,6 kg

■	kg	€	🔧	📦
1	9,6	1.440,00	1	019300032



1930LA

Schlagschrauber mit Rechts- und Linkslauf

• Doppelter Schlagmechanismus

1"
CE



Drehzahl im Leerlauf	4.000 U/min
Max. Drehmoment	2.445 Nm
Bolzen-Ø	CI 8.8 M36●55 mm
Bolzen-Ø	CI 12.9 M30●46 mm
Luftanschluss	1/2" GAS
Betriebsdruck	6,2 bar
Innen-Ø Luftschnlauch	13 mm
Durchschnittlicher Luftverbrauch	460 l/min
Gewicht	10,6 kg

1"	kg	€	1	019300037
1	10,6	1.520,00	1	019300037

1930HLA

Schlagschrauber mit Rechts- und Linkslauf

• Doppelter Schlagmechanismus

1"
CE



Drehzahl im Leerlauf	3.000 U/min
Max. Drehmoment	3.661 Nm
Bolzen-Ø	CI 8.8 M42●65 mm
Bolzen-Ø	CI 12.9 M33●50 mm
Luftanschluss	1/2" GAS
Betriebsdruck	6,2 bar
Innen-Ø Luftschnlauch	13 mm
Durchschnittlicher Luftverbrauch	460 l/min
Gewicht	16,4 kg

1"	kg	€	1	019300040
1	16,4	2.100,00	1	019300040

1931CD6

Bohrmaschine mit Rechts- und Linkslauf aus Verbundwerkstoff

CE



Drehzahl im Leerlauf	2.600 U/min
Bohrfutter	1÷6 mm
Motorleistung	0,23 kW
Bohrfutteraufnahme	3/8" - 24UNF
Luftanschluss	1/4" GAS
Betriebsdruck	6,2 bar
Innen-Ø Luftschnlauch	8 mm
Durchschnittlicher Luftverbrauch	130 l/min
Gewicht	0,6 kg

kg	€	1	019310006
0,6	309,00	1	019310006

1930A

Schlagschrauber mit Rechts- und Linkslauf

• Doppelter Schlagmechanismus

1"
CE



Drehzahl im Leerlauf	4.000 U/min
Max. Drehmoment	2.445 Nm
Bolzen-Ø	CI 8.8 M36●55 mm
Bolzen-Ø	CI 12.9 M30●46 mm
Luftanschluss	1/2" GAS
Betriebsdruck	6,2 bar
Innen-Ø Luftschnlauch	13 mm
Durchschnittlicher Luftverbrauch	460 l/min
Gewicht	9,5 kg

1"	kg	€	1	019300036
1	9,5	1.460,00	1	019300036

1930ZL

Schlagschrauber mit Rechts- und Linkslauf

• Doppelter Schlagmechanismus

1 1/2"
CE



Drehzahl im Leerlauf	3.000 U/min
Max. Drehmoment	4.068 Nm
Bolzen-Ø	CI 8.8 M42●65 mm
Bolzen-Ø	CI 12.9 M36●55 mm
Luftanschluss	1/2" GAS
Betriebsdruck	6,2 bar
Innen-Ø Luftschnlauch	13 mm
Durchschnittlicher Luftverbrauch	480 l/min
Gewicht	15 kg

1 1/2"	kg	€	1	019300070
1 1/2	15	2.640,00	1	019300070

1931CD10

Bohrmaschine mit Rechts- und Linkslauf aus Verbundwerkstoff

CE



Drehzahl im Leerlauf	1.800 U/min
Bohrfutter	1÷10 mm
Motorleistung	0,38 kW
Bohrfutteraufnahme	3/8" - 24UNF
Luftanschluss	1/4" GAS
Betriebsdruck	6,2 bar
Innen-Ø Luftschnlauch	10 mm
Durchschnittlicher Luftverbrauch	170 l/min
Gewicht	1 kg

kg	€	1	019310010
1,0	278,00	1	019310010

1931CD13

Bohrmaschine mit Rechts- und Linkslauf aus Verbundwerkstoff



Drehzahl im Leerlauf	800 U/min
Bohrfutter	1,0÷13 mm
Motorleistung	0,38 kW
Bohrfutteraufnahme	1/2" - 20UNC
Luftanschluss	1/4" GAS
Betriebsdruck	6,2 bar
Innen-Ø Luftschlauch	10 mm
Durchschnittlicher Luftverbrauch	170 l/min
Gewicht	1,3 kg

kg 1,3 € 412,00 1 019310013

1932B10

Bohrmaschine mit Rechts- und Linkslauf



Drehzahl im Leerlauf	1.800 U/min
Bohrfutter	1÷10 mm
Motorleistung	0,44 kW
Bohrfutteraufnahme	3/8" - 24UNF
Luftanschluss	1/4" GAS
Betriebsdruck	6,2 bar
Innen-Ø Luftschlauch	10 mm
Durchschnittlicher Luftverbrauch	160 l/min
Gewicht	1,2 kg

kg 1,2 € 221,00 1 019320040

1932B13

Bohrmaschine mit Rechts- und Linkslauf



Drehzahl im Leerlauf	400 U/min
Bohrfutter	1,5÷13 mm
Motorleistung	0,34 kW
Bohrfutteraufnahme	1/2" - 20UNC
Luftanschluss	1/4" GAS
Betriebsdruck	6,2 bar
Innen-Ø Luftschlauch	10 mm
Durchschnittlicher Luftverbrauch	180 l/min
Gewicht	1,6 kg

kg 1,6 € 330,00 1 019320004

1931AN10

Winkelbohrmaschine mit Rechts- und Linkslauf



Drehzahl im Leerlauf	1.400 U/min
Bohrfutter	1÷10 mm
Motorleistung	0,38 kW
Bohrfutteraufnahme	3/8" - 24UNF
Luftanschluss	1/4" GAS
Betriebsdruck	6,2 bar
Innen-Ø Luftschlauch	10 mm
Durchschnittlicher Luftverbrauch	150 l/min
Gewicht	1,1 kg

kg 1,1 € 309,00 1 019310030

1932RS13

Bohrmaschine mit Rechts- und Linkslauf



Drehzahl im Leerlauf	750 U/min
Bohrfutter	1,5÷13 mm
Motorleistung	0,55 kW
Bohrfutteraufnahme	3/8" - 24UNF
Luftanschluss	1/4" GAS
Betriebsdruck	6,2 bar
Innen-Ø Luftschlauch	10 mm
Durchschnittlicher Luftverbrauch	160 l/min
Gewicht	1,4 kg

kg 1,4 € 280,00 1 019320043

1933IH

Hochleistungsfähiger Einhandstabschleifer

• Lieferung mit Ø 3 und 6 mm Spannzange



Drehzahl im Leerlauf	20.000 U/min
Spannzange	3 - 6 mm
Motorleistung	0,75 kW
Bohrfutteraufnahme	1/4" GAS
Betriebsdruck	6,2 bar
Innen-Ø Luftschlauch	10 mm
Durchschnittlicher Luftverbrauch	370 l/min
Gewicht	800 g

g 800 € 251,00 1 019330006



19331LH

Hochleistungsfähiger Einhandstabschleifer mit langer Antriebsspindel

• Lieferung mit Ø 3 und 6 mm Spannzanze

CE



Drehzahl im Leerlauf	20.000 U/min
Spannzanze	3 - 6 mm
Motorleistung	0,75 kW
Bohrfutteraufnahme	1/4" GAS
Betriebsdruck	6,2 bar
Innen-Ø Luftschauch	10 mm
Durchschnittlicher Luftverbrauch	370 l/min
Gewicht	1,2 kg

kg 1,2 € 470,00 1 019330011

1933AN90-H

Hochleistungsfähiger Einhandwinkelschleifer

• Lieferung mit Ø 3 und 6 mm Spannzanze

CE



Drehzahl im Leerlauf	15.000 U/min
Spannzanze	3 - 6 mm
Motorleistung	0,75 kW
Bohrfutteraufnahme	1/4" GAS
Betriebsdruck	6,2 bar
Innen-Ø Luftschauch	10 mm
Durchschnittlicher Luftverbrauch	370 l/min
Gewicht	1,1 kg

kg 1,1 € 470,00 1 019330021

1933

Einhandstabschleifer

• Lieferung mit Ø 3 und 6 mm Spannzanze

CE



Drehzahl im Leerlauf	25.000 U/min
Spannzanze	3 - 6 mm
Motorleistung	0,20 kW
Bohrfutteraufnahme	1/4" GAS
Betriebsdruck	6,2 bar
Innen-Ø Luftschauch	10 mm
Durchschnittlicher Luftverbrauch	230 l/min
Gewicht	380 g

kg 380 € 165,00 1 019330001

19331

Einhandstabschleifer

• Lieferung mit Ø 3 und 6 mm Spannzanze

CE



Drehzahl im Leerlauf	20.000 U/min
Spannzanze	3 - 6 mm
Motorleistung	0,38 kW
Bohrfutteraufnahme	1/4" GAS
Betriebsdruck	6,2 bar
Innen-Ø Luftschauch	10 mm
Durchschnittlicher Luftverbrauch	260 l/min
Gewicht	670 g

g 670 € 187,00 1 019330005

1933L

Einhandstabschleifer mit langer Antriebsspindel

• Lieferung mit Ø 3 und 6 mm Spannzanze

CE



Drehzahl im Leerlauf	25.000 U/min
Spannzanze	3 - 6 mm
Motorleistung	0,20 kW
Bohrfutteraufnahme	1/4" GAS
Betriebsdruck	6,2 bar
Innen-Ø Luftschauch	10 mm
Durchschnittlicher Luftverbrauch	270 l/min
Gewicht	670 g

g 670 € 210,00 1 019330015

19331L

Einhandstabschleifer mit langer Antriebsspindel

• Lieferung mit Ø 3 und 6 mm Spannzanze

CE



Drehzahl im Leerlauf	20.000 U/min
Spannzanze	3 - 6 mm
Motorleistung	0,38 kW
Bohrfutteraufnahme	1/4" GAS
Betriebsdruck	6,2 bar
Innen-Ø Luftschauch	10 mm
Durchschnittlicher Luftverbrauch	113 l/min
Gewicht	1,4 kg

kg 1,4 € 255,00 1 019330010

1933AN90

Einhandwinkelschleifer

• Lieferung mit Ø 3 und 6 mm Spannzanze

CE



Drehzahl im Leerlauf	20.000 U/min
Spannzanze	3 - 6 mm
Motorleistung	0,20 kW
Bohrfutteraufnahme	1/4" GAS
Betriebsdruck	6,2 bar
Innen-Ø Luftschauch	10 mm
Durchschnittlicher Luftverbrauch	230 l/min
Gewicht	510 g

g 510 € 210,00 1 019330020

1934BV

Langsamlaufende Poliermaschine

• Lieferung mit Ø 3 und 6 mm Spannzanze

CE



Drehzahl im Leerlauf	3.700 U/min
Spannzanze	3 - 6 mm
Motorleistung	0,37 kW
Luftanschluss	1/4" GAS
Betriebsdruck	6,2 bar
Innen-Ø Luftschauch	10 mm
Durchschnittlicher Luftverbrauch	113 l/min
Gewicht	0,84 kg

g 840 € 227,00 1 019340000



1934MAV

Mikro-Einhandstabschleifer

CE



Drehzahl im Leerlauf	56.000 U/min
Spannzange	3 mm
Motorleistung	0,04 kW
Luftanschluss	1/4" GAS BSPT
Betriebsdruck	6,2 bar
Innen-Ø Luftschlauch	4,5 mm
Durchschnittlicher Luftverbrauch	115 l/min
Gewicht	0,2 kg

g 205 € 195,00 1 019340010

1934MAV70

Hochgeschwindigkeits-Mikro-Einhandstabschleifer

CE



Drehzahl im Leerlauf	70.000 U/min
Spannzange	3 mm
Motorleistung	0,08 kW
Luftanschluss	1/4" GAS BSPT
Betriebsdruck	6,2 bar
Innen-Ø Luftschlauch	4,5 mm
Durchschnittlicher Luftverbrauch	115 l/min
Gewicht	0,21 kg

g 210 € 323,00 1 019340030

1935F

Druckluft-Dreherschrauber mit Rechts- und Linkslauf

1/4

CE



Drehzahl im Leerlauf	800 U/min
Drehmoment	4-16 Nm
Bolzen-Ø	6-9 M
Einsatzhalter	● 1/4"
Bohrfutteraufnahme	1/4" GAS
Betriebsdruck	6,2 bar
Innen-Ø Luftschlauch	10 mm
Durchschnittlicher Luftverbrauch	150 l/min
Gewicht	1,3 kg

kg 1,3 € 309,00 1 019350045

1936/4A

Winkelschleifer

CE



Drehzahl im Leerlauf	11.000 U/min
Tellergröße	115 mm
Motorleistung	0,66 kW
Bohrfutteraufnahme	M14
Luftanschluss	1/4" GAS
Betriebsdruck	6,2 bar
Innen-Ø Luftschlauch	10 mm
Durchschnittlicher Luftverbrauch	390 l/min
Gewicht	1,77 kg

kg 1,8 € 508,00 1 019360024

1936/5A

Winkelschleifer

CE



Drehzahl im Leerlauf	10.000 U/min
Tellergröße	125 mm
Motorleistung	0,66 kW
Bohrfutteraufnahme	M14
Bohrfutteraufnahme	1/4" GAS
Betriebsdruck	6,2 bar
Innen-Ø Luftschlauch	10 mm
Durchschnittlicher Luftverbrauch	390 l/min
Gewicht	1,9 kg

kg 1,9 € 508,00 1 019360025

1936/7A

Winkelschleifer

CE



Drehzahl im Leerlauf	7600 giri/min
Tellergröße	180 mm
Motorleistung	1,3 kW
Bohrfutteraufnahme	M14
Bohrfutteraufnahme	3/8" GAS
Betriebsdruck	6,2 bar
Innen-Ø Luftschlauch	13 mm
Durchschnittlicher Luftverbrauch	906 l/min
Gewicht	2,7 kg

kg 2,7 € 745,00 1 019360027



1937

Exzentrerschleifer mit Handballgriff, schmierfrei, aus Verbundwerkstoff

- Durchmesser Schwingkreis 5 mm



Drehzahl im Leerlauf	12.000 U/min
Motorleistung	0,18 kW
Abmessung Schleifteller	150 mm
Durchmesser Schwingkreis	5 mm
Bohrfutteraufnahme	5/16"-24
Luftanschluss	1/4" GAS
Betriebsdruck	6,2 bar
Innen-Ø Luftschlauch	10 mm
Durchschnittlicher Luftverbrauch	170 l/min
Gewicht	0,86 kg

kg	€		
0,86	536,00	1	019370001

1937R/P

Schleifteller Ø 150 mm, 6-löchrig für Art. 1937



1937R/P	€		
	56,00	1	019370002

1937KC

Exzentrischer Mini-Schleifer

- Durchmesser Schwingkreis: 4 mm
- 2 Schleifteller Ø 50 mm und Ø 75 mm
- 10 Schleifpapierscheiben Ø 50 mm, mit Korngröße 400, 600, 800
- 10 Schleifpapierscheiben Ø 75 mm, mit Korngröße 400, 600, 800



Drehzahl im Leerlauf	15000
Leistung	0,25
Schleifscheibengröße	50 - 75
Spindelgewinde	M6 x 1,0
Luftanschluss	1/4" BSPT
Betriebsdruck	6,2
Innen-Ø Luftschlauch	10
Durchschnittlicher Luftverbrauch	79
Gewicht Schleifer	0,64
Gewicht Kit	1,4

kg	€		
1,4	308,00	1	019370171

1937C...

Schleifpapierscheiben für Art. 1937KC



Ø mm	P	€		
50	400	18,40	1	019370175
50	600	18,40	1	019370176
50	800	18,40	1	019370177
75	400	23,30	1	019370178
75	600	23,30	1	019370179
75	800	23,30	1	019370180

* Die angegebenen Preise beziehen sich auf 10 Stück

1937KL

Mini-Polierer

- Schleifteller Ø 75 mm
- 2 Polierschwämme Ø 90 mm - 1937/KL-DSB, 1937/KL-DSG
- Lammwollpad Ø 90 mm - 1937/KL-DLA



Drehzahl im Leerlauf	3.200 U/min
Leistung	0,25 kW
Schleifscheibengröße	75 mm
Spindelgewinde	M6
Luftanschluss	1/4" GAS BSPT
Betriebsdruck	6,2 Bar
Innen-Ø Luftschlauch	10 mm
Durchschnittlicher Luftverbrauch	91 l/min
Gewicht Polierer	0,75 kg
Gewicht Kit	1,8 kg

kg	€		
1,8	334,00	1	019370161

1937KL-D

Zubehör für Art. 1937KL



	Ø mm	€		
1937KL-DLA	90	30,00	1	019370164
1937KL-DSB	90	30,00	1	019370165
1937KL-DSG	90	30,00	1	019370166

1937K...

Schleifteller für Art. 1937KC und Art. 1937KL



	Ø mm	1937KC	1937KL	€		
1937KC-RP	50	•		33,00	1	019370173
1937KL-RP	75	•	•	39,50	1	019370163

1937M

Multifunktions-Schleifer mit 16 Zubehörteilen



Drehzahl im Leerlauf	3.500 U/min
Motorleistung	0,34 kW
Bohrfutteraufnahme	1/4" GAS
Betriebsdruck	6,2 bar
Innen-Ø Luftschlauch	10 mm
Durchschnittlicher Luftverbrauch	113 l/min
Gewicht Schleifer	1,5 kg
Gewicht Satz	4,5 kg

kg	€		
4,5	926,00	1	019370011

458x495x116 mm

1937M-01÷11

Zubehör für Art. 1937M



L mm	1937M-	€		
1937M-01	30	34,50	1	019370101
1937M-02	30	34,50	1	019370102
1937M-03	11	30,00	1	019370103
1937M-04	23	30,00	1	019370104
1937M-05	11	30,00	1	019370105
1937M-06	23	30,00	1	019370106
* 1937M-07	16	82,50	1	019370107
1937M-08	13 07	30,00	1	019370108
1937M-09	26 07	30,00	1	019370109
1937M-10	11 03,05	30,00	1	019370110
1937M-11	23 01,02,04,06	30,00	1	019370111

* Die angegebenen Preise beziehen sich auf 6 Stück

1937N10

Bandschleifmaschine



Drehzahl im Leerlauf	20.000 U/min
Motorleistung	0,37 kW
Bandmaße	10x330 mm
Bohrfutteraufnahme	1/4" GAS
Betriebsdruck	6,2 bar
Innen-Ø Luftschlauch	10 mm
Durchschnittlicher Luftverbrauch	374 l/min
Gewicht	0,9 kg

kg	€		
0,9	361,00	1	019370041

1937N10-GR

Schleifbänder für Art. 1937N10



1937N10-GR60	P 60	€ 38,00	1	019370146
1937N10-GR80	P 80	€ 38,00	1	019370148
1937N10-GR100	P 100	€ 38,00	1	019370150
1937N10-GR120	P 120	€ 38,00	1	019370152

Die angegebenen Preise beziehen sich auf 10 Stück

1937N20

Bandschleifmaschine



Drehzahl im Leerlauf	16.000 U/min
Motorleistung	0,45 kW
Bandmaße	20x520 mm
Bohrfutteraufnahme	1/4" GAS
Betriebsdruck	6,2 bar
Innen-Ø Luftschlauch	10 mm
Durchschnittlicher Luftverbrauch	400 l/min
Gewicht	1,6 kg

kg	€		
1,6	420,00	1	019370051

1937N20-GR

Schleifbänder für Art. 1937N20



1937N20-GR60	P 60	€ 49,50	1	019370156
1937N20-GR80	P 80	€ 49,50	1	019370158
1937N20-GR100	P 100	€ 49,50	1	019370160
1937N20-GR120	P 120	€ 49,50	1	019370162

Die angegebenen Preise beziehen sich auf 10 Stück

1938

Windschutzscheibenfenster

• Mit 1 gerader 57 mm Klinge



Schwingungen pro Minute	20.000
Luftanschluss	1/4" GAS
Betriebsdruck	6,2 bar
Innen-Ø Luftschlauch	6,5 mm
Durchschnittlicher Luftverbrauch	200 l/min
Gewicht	1,0 kg

kg	€		
1,0	283,00	1	019380021

1938R/L

Klingen für Scheibenablöser

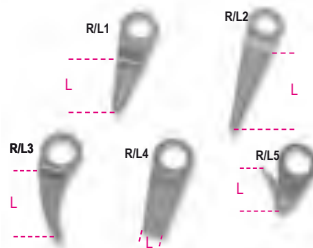

1938R/L1	L mm 57	€ 24,00	1	019380041
1938R/L2	L mm 90	€ 44,50	1	019380042
1938R/L3	L mm 30	€ 27,00	1	019380043
1938R/L4	L mm 8	€ 38,00	1	019380044
1938R/L5	L mm 36	€ 44,00	1	019380045

1938R/S5

Klingensatz für Windschutzscheibenentferner Art. 1938, 5teilig

1938R/S5	€ 177,00	1	019380055
----------	----------	---	-----------

1940

Meißelhammer

• Mit Hammerfeder und Schnellwechselfutter mit Sechskant-Spitzen



Schlagzahl/Min.	3.500
Werkzeugaufnahme	Ø 11 mm
Kolbenabmessung	19 mm
Kolbenhub	67 mm
Bohrfutteraufnahme	1/4" GAS
Betriebsdruck	6,2 bar
Innen-Ø Luftschlauch	8 mm
Durchschnittlicher Luftverbrauch	240 l/min
Gewicht	1,9 kg

kg	€		
1,9	227,00	1	019400001

1940/C6

Meißelhammer mit 5 Meißeln und Zubehör

• Ermöglicht das Schneiden von Blechen, Bolzen und Karosserien sowie das Entfernen von Schweißpunkten, Nieten, Putz und Fliesen
• Sortiment in einem praktischen Werkzeugkoffer aus ABS, bestehend aus:

- 1 Meißelhammer Art. 1940
- 1 Flachmeißel Art. 1940SN
- 1 Abbruchmeißel Art. 1940ST
- 1 Spitzmeißel Art. 1940SD
- 1 Kreuzmeißel Art. 1940SPS
- 1 Blechtrennmeißel Art. 1940SDT
- 1 Hammerfeder Art. 1940MT
- 1 Schnellwechselfutter mit Sechskant-Spitzen



Schlagzahl/Min.	3.500
Werkzeugaufnahme	Ø 11 mm
Kolbenabmessung	19 mm
Kolbenhub	67 mm
Bohrfutteraufnahme	1/4" GAS
Betriebsdruck	6,2 bar
Innen-Ø Luftschlauch	8 mm
Durchschnittlicher Luftverbrauch	240 l/min
Gewicht	3,3 kg

kg	€		
3,3	334,00	1	019400000
≡ 320x240x90 mm			

1940MT

Hammerfeder für Art. 1940



1940MT	€ 14,90	5	019400110
--------	---------	---	-----------

1940S...

Meißel für Meißelhämmer Art. 1940



1940SN	€ 18,30	5	019400020
1940ST	€ 18,30	5	019400021
1940SD	€ 18,30	5	019400022
1940SPS	€ 18,30	5	019400023
1940SDT	€ 18,30	5	019400024

1940/S5

Meißelsatz, 5-teilig, für Meißelhämmer Art. 1940



1940/S5	€ 83,00	1	019400030
---------	---------	---	-----------

1940E10

Meißelhammer

- Kompatibel mit Meißeln mit Sechskantanschluss 10 mm
- Mit Hammerfeder und Schnellwechselfutter



Schlagzahl/Min.	2.900
Werkzeugaufnahme	○ 10 mm
Kolbenabmessung	19 mm
Kolbenhub	67 mm
Luftzufuhr	1/4" GAS
Betriebsdruck	6,2 bar
Innen-Ø Luftschlauch	10 mm
Durchschnittlicher Luftverbrauch	76 l/min
Gewicht	1,7 kg

kg 1,7	€ 251,00	1	019400010
--------	----------	---	-----------

1940E10/MT

Hammerfeder für Art. 1940E10



1940E10/MT	€ 2,10	5	019400112
------------	--------	---	-----------

1940E10/S...

Meißel für Meißelhämmer Art. 1940E10



1940E10/SN	€ 12,80	5	019400040
1940E10/ST	€ 12,80	5	019400041
1940E10/SD	€ 12,80	5	019400042
1940E10/SPS	€ 12,80	5	019400043
1940E10/SDT	€ 12,80	5	019400044

1940E10/S5

Meißelsatz, 5-teilig, für Meißelhämmer Art. 1940E10



1940E10/S5	€ 63,00	1	019400050
------------	---------	---	-----------

1942A

Blechsäge

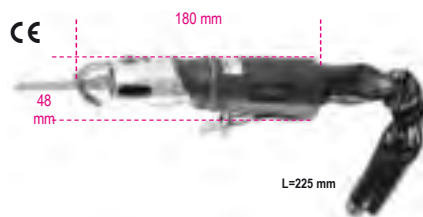

Hubzahl/Min.	10.000
Hublänge	10 mm
Luftanschluss	1/4" GAS BSP
Betriebsdruck	6,2 bar
Innen-Ø Luftschlauch	8 mm
Durchschnittlicher Luftverbrauch	75 l/min
Gewicht	550 g

kg 550	€ 378,00	1	019420000
--------	----------	---	-----------

1942LR

Bimetall-Blätter für Blechsäge Art. 1942A



1942LR	€ 8,90	5	019420032
--------	--------	---	-----------

1944A

Axial-Nadelntroster

CE



Schlagzahl/Min.	3.800
Kolbenhub	33 mm
Anzahl der Nadeln	19
Nadel-Ø	3 mm
Luftanschluss	1/4" GAS
Betriebsdruck	6,2 bar
Innen-Ø Luftschlauch	10 mm
Durchschnittlicher Luftverbrauch	85 l/min
Gewicht	2,8 kg

kg 2,8	€ 426,00	1	019440011
--------	----------	---	-----------

1944N

Nadelntroster



Schlagzahl/Min.	3800
Kolbenhub	33 mm
Anzahl der Nadeln	19
Nadel-Ø	3 mm
Luftanschluss	1/4" GAS
Betriebsdruck	6,2 bar
Innen-Ø Luftschlauch	8 mm
Durchschnittlicher Luftverbrauch	85 l/min
Gewicht	2,7 kg

kg 2,7	€ 544,00	1	019440002
--------	----------	---	-----------

1944AR

Ersatznadelsatz, für Nadelntroster Art. 1944A und 1944N



1944AR 2	Ø mm 2	n. 29	€ 56,00	1	019440015
1944AR 3	Ø mm 3	n. 19	€ 44,00	1	019440005

1944PA

Nadelhalterplatten für Art. 1944N und Art. 1944A



	Ø mm	N.	€	🔧	📦
1944PA 2	2	29	61,50	1	019440016
1944PA 3	3	19	47,00	1	019440006

1945S

Klammergerät

• Verwendet Klammern Typ 80, Querschnitt 0,95 x 0,65 mm (21 Gauge), Länge 4 - 16 mm, Breite 12,8 mm



Fassungsvermögen Lademagazin	157 Stk.
Luftanschluss	1/4" GAS
Betriebsdruck	4,2 - 7 bar
Innen-Ø Luftschlauch	8 mm
Luftverbrauch (7 bar)	0,34 l/Zyklus
Gewicht	0,87 kg

kg	€	🔧	📦
0,9	232,00	1	019450000

1945S/G...

Klammern Typ 80, Querschnitt 0,95x0,65 mm (21 Gauge), Breite 12,8 mm, für Art. 1945S



	L mm	€	🔧	📦
• 1945S/G 4	4	21,60	1	019450004
1945S/G 6	6	8,60	1	019450006
1945S/G 8	8	9,30	1	019450008
1945S/G 10	10	10,30	1	019450010
1945S/G 12	12	11,50	1	019450012
1945S/G 14	14	12,70	1	019450014
1945S/G 16	16	13,70	1	019450016

Die angegebenen Preise beziehen sich auf 5.000 Stk.
• Die angegebenen Preise beziehen sich auf 10.000 Stk.

1945C

Nagel- und Klammergerät

• Verwendet Klammern Typ 90, Querschnitt 1,25 x 1,0 mm (18 Gauge), Länge 16 - 40 mm, Breite 5,8 mm
• Verwendet Nägel Typ B12, Querschnitt 1,25 x 1,0 mm (18 Gauge), Kopf 1,9 mm



Fassungsvermögen Lademagazin	100 Stk.
Luftanschluss	1/4" GAS
Betriebsdruck	5 - 8 bar
Innen-Ø Luftschlauch	8 mm
Luftverbrauch (7 bar)	1,12 l/Zyklus
Gewicht	1,16 kg

kg	€	🔧	📦
1,16	305,00	1	019450200

1945C/G...

Klammern Typ 90, Querschnitt 1,25x1,0 mm (18 Gauge), Breite 5,8 mm, für Art. 1945C



	L mm	€	🔧	📦
1945C/G 16	16	16,40	1	019450216
1945C/G 19	19	19,30	1	019450219
1945C/G 22	22	21,20	1	019450222
1945C/G 25	25	25,00	1	019450225
1945C/G 28	28	26,50	1	019450228
1945C/G 32	32	30,50	1	019450232
1945C/G 35	35	33,00	1	019450235
1945C/G 38	38	37,00	1	019450238
1945C/G 40	40	39,00	1	019450240

Die angegebenen Preise beziehen sich auf 5.000 Stk.

1945C/GP...

Nägel Typ B12, Querschnitt 1,25x1,0 mm (18 Gauge), Kopf 1,9 mm, für Art. 1945C



	L mm	€	🔧	📦
1945C/GP 15	15	8,70	1	019450255
1945C/GP 16	16	9,10	1	019450256
1945C/GP 20	20	10,30	1	019450260
1945C/GP 25	25	12,10	1	019450265
1945C/GP 30	30	14,10	1	019450270
1945C/GP 32	32	15,60	1	019450272
1945C/GP 35	35	16,70	1	019450275
1945C/GP 38	38	18,00	1	019450278
1945C/GP 40	40	18,60	1	019450280
1945C/GP 45	45	20,60	1	019450285
1945C/GP 50	50	22,60	1	019450290

Die angegebenen Preise beziehen sich auf 5.000 Stk.



1945P

Heftergerät

• Verwendet Stecknadeln Typ B6, Ø 0,64 mm (23 Gauge), Länge 12 - 35 mm



Fassungsvermögen Lademagazin	145 Stk.
Luftanschluss	1/4" GAS
Betriebsdruck	4 - 7 bar
Innen-Ø Luftschlauch	8 mm
Luftverbrauch (7 bar)	0,27 l/Zyklus
Gewicht	0,87 kg

kg	€	🔧	📦
0,87	370,00	1	019450100

1945P/S...

Stecknadeln Typ B6, Ø 0,64 mm (23 Gauge), für Art. 1945P



	L mm	€	🔧	📦
1945P/S 12	12	10,10	1	019450112
1945P/S 15	15	11,20	1	019450115
1945P/S 18	18	12,00	1	019450118
1945P/S 20	20	13,90	1	019450120
1945P/S 21	21	14,10	1	019450121
1945P/S 22	22	14,50	1	019450122
1945P/S 25	25	15,60	1	019450125
1945P/S 30	30	17,80	1	019450130
1945P/S 35	35	20,20	1	019450135

Die angegebenen Preise beziehen sich auf 10.000 Stk.



1946 Blindnietpistole

• Mit auswechselbaren Mundstücken für Nieten Ø 2,4 - 3,2 - 4,0 - 4,8 mm.

CE



Zugkraft	8000 N
Hublänge	14 mm
Max. Ø Nieten	Ø Aluminium 4,8 mm
Bohrfutteraufnahme	1/4" GAS
Betriebsdruck	6,2 bar
Innen-Ø Luftschnlauch	6 mm
Luftverbrauch	1,2 Hub
Gewicht	1,5 kg

kg	€		
1,5	230,00	1	019460001

1946C4,8 Blindnietpistole

• Automatische Absaugung
• Geliefert für den Einsatz für Stahl-, Edelstahl-, Aluminium- und Kupfernieten 2,4 - 3,2 - 4,0 - 4,8 mm

CE



Zugkraft	8.900 N
Hublänge	15 mm
Max. Ø Nieten	Ø Edelstahl 4,8 mm
Luftzufuhr	1/4" GAS
Betriebsdruck	6,2 bar
Luftschnlauch- Innendurchmesser (Ø)	10 mm
Luftverbrauch	2,6 l/Zyklus
Gewicht	1,5 kg

kg	€		
1,5	718,00	1	019460006

1946C7,8 Blindnietpistole

• Automatische Absaugung
• Geliefert für den Einsatz für Stahl-, Edelstahl-, Aluminium- und Kupfernieten 4,8 - 5,6 - 6,4 - 7,8 mm

CE



Zugkraft	16.900 N
Hublänge	22,5 mm
Max. Ø Nieten	Ø Edelstahl 7,8 mm
Luftzufuhr	1/4" GAS
Betriebsdruck	6,2 bar
Luftschnlauch- Innendurchmesser (Ø)	10 mm
Luftverbrauch	4,9 l/Zyklus
Gewicht	1,8 kg

kg	€		
1,8	1.130,00	1	019460008

1946C/T... Köpfe für strukturelle Blindnieten



	Ø mm	€		
1946C/T4,8	4,8	44,00	1	019460016
1946C/T6,4	6,4	44,00	1	019460018

1946KF Blindnietpistole für Gewindeeinsätze

• Zusammengebaut geliefert für Gewindenieten aus Stahl, Edelstahl, Aluminium und Kupfer, M4, M5, M6, M8

CE



Zugkraft	14.235 N
Hublänge	7 mm
Max. Ø Nieten	Ø Edelstahl M8
Luftanschluss	1/4" GAS
Betriebsdruck	6,2 bar
Innen-Ø Luftschnlauch	10 mm
Luftverbrauch	2,1 l/Hub
Gewicht Blindnietpistole	2,1 kg
Gewicht Satz	3,4 kg

kg	€		
3,4	2.380,00	1	019460012

1946KF/M... Ersatzstifte für Art. 1946KF



	€		
1946KF/M4	79,50	1	019460124
1946KF/M5	79,50	1	019460125
1946KF/M6	79,50	1	019460126
1946KF/M8	76,50	1	019460128

1947 Pistole für Dichtungsmasse

• Luftdruckpistole für Silikon, Kleber und Dichtmassen mittlerer Stärke
• Unterstützt Standardkartuschen (210 x 50 mm), starre und weiche

CE



Abmessung des Schlauchs	210x50 mm
Kartuschen Fassungsvermögen	350 ml
Bohrfutteraufnahme	1/4" GAS
Betriebsdruck	4,8 bar
Innen-Ø Luftschnlauch	10 mm
Durchschnittlicher Luftverbrauch	120 l/min
Gewicht	1,1 kg

kg	€		
1,1	80,50	1	019470001

1947H Bonding-Pistole

• Luftdruckpistole für Extrusion von Silikon und Kleber aus Standardkunststoff- oder Metallkartusche
• Unterstützt Standardkartuschen (215/218 x 50/51 mm), starre und weiche
• Eingebautes Druckreduktionsventil

CE



Abmessung des Schlauchs	210x50 mm
Kartuschen Fassungsvermögen	300/310 ml
Luftzufuhr	1/4" GAS
Betriebsdruck	4 + 8 bar
Innen-Ø Luftschnlauch	2,5 mm
Durchschnittlicher Luftverbrauch	120 l/min
Gewicht	750 g

g	€		
750	280,00	1	019470011

1947G

Schmierpistole

Fließgepresster Kopf aus Aluminium
Ergonomischer Griff mit Kantenform für den Zugang auf enge Stellen
Messingventil für eine hohe Lebensdauer
Funktioniert mit 400 g Kartuschen oder losem Fett bis zu 500 cc
Schlauchabmessungen: 54 (intern) x 260 mm
Luftanschluss: 1/4" GAS
Betriebsdruck: 4÷10 bar
Gewicht: 1,9 kg

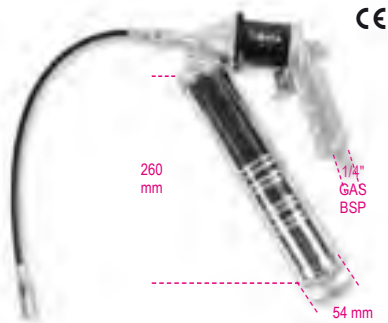

1947G € 198,00 1 019470051

1947G2

Schmierpistole 2 in 1

Zur stufenweise oder kontinuierlichen Fettabgabe
Fließgepresster Kopf aus Aluminium
Ergonomischer Griff
Funktioniert mit 400 g Kartuschen oder losem Fett bis zu 500 cc



Schlauchabmessungen 54 (intern) x 276 mm
Luftanschluss 1/4" GAS BSP
Betriebsdruck 3÷10 bar
Gewicht 2,2 kg

1947G2 € 204,00 1 019470060

1948

Gravurstift

• Ermöglicht das Gravieren von Werkstoffen wie Stahl, Edelstahl, Aluminium, Glas, Stein und Keramik



CE
Schlagzahl/Min. 3.500 ÷ 3.800
Maximale Härte 60 HRC
Luftanschluss 1/4" GAS
Betriebsdruck 6,2 bar
Durchschnittlicher Luftverbrauch 50 l/min
Gewicht 150 g

150 g € 371,00 1 019480001

1948PR

Ersatz-Wolframkarbidspitze für Art. 1948

• Maximale Härte: 60 HRC



1948PR € 141,00 1 019480005

1949XS

Progressive Stiftblaspistole

• Aus Leichtmetall
• Durch Drehen des Kopfes modulierbarer Strahl



Gewinde 1/4" GAS
Betriebsdruck 3-8 bar
Max. Betriebsdruck 10 bar
Betriebstemperatur -20°C ÷ 70°C
Gewicht 20 g

20 g € 9,00 25 019490025

1949U5

Ausblaspistole mit progressiv dosierbarer Blaswirkung, mit 5 Düsen

• Körper aus widerstandsfähigem und stoßfestem Verbundmaterial
• 3 Stahldüsen 100/160/320 mm mit Schutzspitze aus kratzfestem Gummi
• 1 Düse "Turbo" aus verstärktem Nylon mit Glasfaser mit Sicherheitskappe
• 1 schwenkbare Düse 100 mm aus verstärktem Nylon mit Glasfaser
• Ausgestattet mit Schnellbefestigungssystem



Gewindemessinginsatz 1/4" GAS
Betriebsdruck 10 bar
Maximale Betriebsdruck 15 bar
Durchschnittlicher Luftverbrauch 280 l/min
Betriebstemperatur -10°C ÷ 85°C
Gewicht 93 g

93 g € 44,50 1 019490030

1949U5/A

Stahldüse 100 mm mit Schutzkappe aus kratzfestem Gummi für Art. 1949U5 - 1949P



1949U5/A € 9,10 1 019490131

1949U5/B

Stahldüse 160 mm mit Schutzkappe aus kratzfestem Gummi für Art. 1949U5 - 1949P



1949U5/B € 9,20 1 019490132

1949U5/C

Stahldüse 320 mm mit Schutzkappe aus kratzfestem Gummi für Art. 1949U5 - 1949P



1949U5/C € 11,70 1 019490133

1949U5/D

Schwenkdüse 100 mm aus verstärktem Nylon mit Glasfaser für Art. 1949U5 - 1949P



1949U5/D € 8,60 1 019490134

Beta

1949U5/E

"Turbo" Düse aus verstärktem Nylon mit Glasfaser mit Sicherheitskappe



1949U5/E € 4,40 1 019490135

1949U5/F

Flachstrahldüse, aus glasfaserverstärktem Glasfaser, für Art. 1949U5 und Art. 1949P



1949U5/F € 5,50 1 019490136

1949U5/G

OSHA-Düse, aus glasfaserverstärktem Glasfaser, für Art. 1949U5 und Art. 1949P



1949U5/G € 4,20 1 019490137

1949BC

Progressive Ausblaspistole mit Gummidüse

- Körper aus widerstandsfähigem und stoßfestem Verbundmaterial
- Kratzfeste Gummidüse, austauschbar



Aluminiumeinsatz, Innengewinde 1/4" GAS
 Betriebsdruck 6-8 bar
 Max. Betriebsdruck 15 bar
 Durchschnittlicher Luftverbrauch 87 l/min
 Betriebstemperatur -20°C + 70°C
 Gewicht 120 g

g 120 € 21,70 1 019490022

1949BC/RUL

5 lange Düsen mit Gummikappen für Art. 1949BC



1949BC/RUL € 27,00 1 019490123

1949P

Mini-Ausblaspistole mit progressiv dosierbarer Blaswirkung

- Körper aus widerstandsfähigem und stoßfestem Verbundmaterial
- Schnellbefestigungssystem der Düsen
- Luftstromregelung über Drehregler

Ø 1/4" GAS BSPT



Messinginsatz 1/4" GAS
 Betriebsdruck 6÷8 bar
 Max. Betriebsdruck 15 bar
 Durchschnittlicher Luftverbrauch 280 l/min
 Betriebstemperatur -10 °C + 85 °C
 Gewicht 70 g

g 70 € 29,00 1 019490031

1949T

Teleskop-Ausblaspistole mit progressiv dosierbarer Blaswirkung

- Körper aus widerstandsfähigem und stoßfestem Verbundmaterial
- Schwenkbare Teleskoprohr aus Stahl: 165 mm ÷ 300 mm

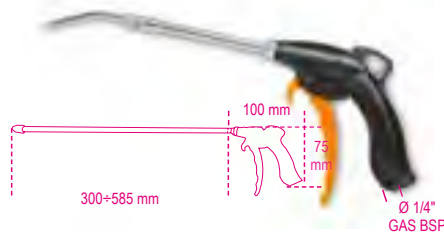

Aluminiumeinsatz, Innengewinde 1/4" GAS
 Betriebsdruck 6÷8 bar
 Max. Betriebsdruck 15 bar
 Durchschnittlicher Luftverbrauch 144 l/min
 Betriebstemperatur -20°C + 70°C
 Gewicht 190 g

g 190 € 34,50 1 019490040



1949F2

Ausblaspistole mit progressiv dosierbarer Blaswirkung

- Aus hoch widerstandsfähigem, stoß- und kratzfestem sowie wärmeisoliertem Kunststoffverbundmaterial
- Das Sonderventil und der Hebel ermöglichen die allmähliche Öffnung des Kreises, wodurch der Luftdurchfluss optimiert wird
- Spitze mit Sicherheitskegel aus Kunststoff für ein sicheres Handling bei Nichtgebrauch



Messinginsatz, Innengewinde 1/4" GAS
 Betriebsdruck 4-8 bar
 Max. Betriebsdruck 12 bar
 Betriebstemperatur -20 °C + 70 °C
 Gewicht 125 g

g 125 € 20,10 1 019490028

1949GPA

Aufpump pistole für Reifen

- Körper mit stoßfester Gummischutzhülle
- Betätigungshebel aus Metall
- Betriebsdruck: 0,5÷12 bar, 7÷174 psi
- Druckablassfunktion
- Separate Druckmessfunktion
- Schlauchlänge: 58 cm
- 360° Schlauchdrehung
- Luftanschluss: 1/4"



1949GPA bar psi € 130,00 1 019490018
 0,5÷12 7÷174

1949DGT/2

Digital-Aufpump pistole für Reifen

- Körper mit stoßfester Gummischutzhülle
- Betätigungshebel aus Metall
- Betriebsdruck: 0,5÷12 bar, 7÷174 psi
- 4 Maßeinheiten, bar/psi/kpa/kgf
- Hintergrundbeleuchtetes LCD-Display
- Auflösung: 0,05 bar
- Selbstausschaltung nach 1,5 Minuten
- Schlauchlänge: 58 cm
- 360° Schlauchdrehung
- Stromversorgung: 2 AAA Batterien
- Luftanschluss: 1/4"



CE

L = 560 mm
 bar psi € g 1
 1949DGT/2 0,5÷12 7÷174 154,00 1 019490021

1949GPN

Aufpump pistole für Reifen Körper aus ABS

- EWG-Manometer mit Skala 0,7÷12 bar (Unterteilung in 1/10 bar)
- Die beiden servounterstützten Drucktasten ermöglichen genaues und schnelles Aufpumpen (+) und Ablassen (-) der Reifen
- Wird mit Eichungszertifikat geliefert
- Mit Stoßschutzhülle und Einhaköse geliefert
- Wird mit Gewindeanschluss 1/4" GAS geliefert
- Drehbare Luftdruckkupplung für Gummischlauch mit 7 mm Durchmesser

CE



L = 1500 mm
 bar g € g 1
 1949GPN 0,7÷12 810 270,00 1 019490011

1949M

Druckmesser für Reifen



L = 350 mm
 bar psi g € g 1
 1949M 0÷4 5÷60 280 90,00 1 019490400

1949R

Ausblas pistole zur Kühlerreinigung

Die 5 Löcher, die senkrecht auf den Schaft zulaufen, ermöglichen das Entfernen von Schmutz aus Kühlern



L mm € g 1
 600 6 81,00 1 019490050

1950BZK

Reifenwulst sitzer

- Dank dem Nebengriff mit Druckknopf wird das Werkzeug beim Gebrauch immer in der Hand gehalten
- Tankinhalt: 18 l
- Betriebsdruck: 3-8 bar
- Höchstdruck Tank: 16 bar
- Sicherheitsüberdruckventil
- Manometer mit Messkala
- Stutzen aus Kunststoff, um Reifenbeschädigungen zu vermeiden

CE



€ g 1
 1950BZK 372,00 1 019500078

Beta

1951

Wasch pistole

- Geeignet für die Reinigung von Autopolsterung, Teppichboden, Sitzen und Kofferräumen



Drehzahl im Leerlauf 1 L
 Fassungsvermögen Tank 1/4" GAS
 Luftanschluss 6,2 bar
 Betriebsdruck 8 mm
 Innen-Ø Luftschlauch 110 l/min
 Durchschnittlicher Luftverbrauch 650 g

g € g 1
 650 175,00 1 019510051

1951A

Wasch pistole mit Absaugung

- Geeignet für die Reinigung von Autopolsterung, Teppichboden, Sitzen und Kofferräumen
- Zu verwenden mit angemessenen Reinigungsmitteln
- 1000 ml Tank
- Ausgestattet mit Hahn zur Regulierung des Auslaufs der im Tank enthaltenen Flüssigkeit
- Komplett mit Wellrohr 1,8 m

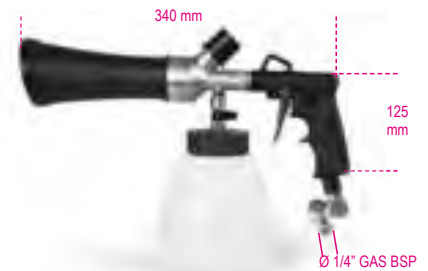

Fassungsvermögen Tank 1 l
 Luftanschluss 1/4" GAS
 Betriebsdruck 6,2 bar
 Innen-Ø Luftschlauch 8 mm
 Durchschnittlicher Luftverbrauch 120 l/min
 Gewicht 800 g

g € g 1
 800 283,00 1 019510101

Beta

1952

Airbrush (Lackerpistole) für professionelle Lackierung

- Körper aus stranggepresstem Aluminium mit Schutzbehandlung aus chemischem schwarzem Nickel
- Fließbecher aus Nylon mit Tropfenfänger, Gewinde 3/8M BSP
- Gewinde am Körper 1/4" BSP Gas zylindrisch
- Druck- und Luftstromregler
- Atomisierungsregler - von ganz auf gefächert
- Lackmengeregler
- Wird mit Serviceschlüssel für Wartungsarbeiten geliefert

CE



	Ø mm	€		
1952 1,2	1,2	187,00	1	019520012
1952 1,5	1,5	187,00	1	019520015
1952 1,8	1,8	187,00	1	019520018
1952 2,0	2,0	187,00	1	019520020

1900S

Automatischer Schlauchaufroller mit Feder, Gehäuse aus schlagfestem Kunststoff, für Luft und Wasser

- Max. Betriebsdruck: 15 bar
- PUR-Druckluftgewebeslauch
- Polypropylen-Gehäuse
- Automatische Vorrichtung zum Stopp des Schlauchaufzugs auf der gewünschten Länge
- Abnehmbarer Klick-Mechanismus (Schlauch immer in Zugrichtung)
- Betriebstemperatur: -5 °C ÷ +50 °C
- Inkl. Bügel, 180° schwenkbar, und Schnellkupplungshalterung

CE



D1xD	L	Ø GAS	€		
mm	m	BSP			
1900S 8X10	8x12	10 1/4"	198,50	1	019000080

1900M

Automatischer Schlauchaufroller mit Feder, Gehäuse aus schlagfestem Kunststoff, für Luft und Wasser

- Max. Betriebsdruck: 15 bar
- PUR-Druckluftgewebeslauch
- Polypropylen-Gehäuse
- Automatische Vorrichtung zum Stopp des Schlauchaufzugs auf der gewünschten Länge
- Abnehmbarer Klick-Mechanismus (Schlauch immer in Zugrichtung)
- Betriebstemperatur: -5 °C ÷ +50 °C
- Inkl. Bügel, 180° schwenkbar, und Schnellkupplungshalterung

CE



D1xD	L	Ø GAS	€		
mm	m	BSP			
1900M 8X15	8x12	15 1/4"	271,00	1	019000085
1900M 10X15	10x14	15 3/8"	283,00	1	019000115

1914

PUR-Spiralschläuche, 98 Shore, ausziehbar

- Max. Betriebsdruck: 12 bar



L	D1xD	Ø GAS	€		
m	mm	BSP			
4	5x8	1/4"	29,50	1	019140054
6	5x8	1/4"	34,50	1	019140056
10	5x8	1/4"	44,50	1	019140060

1915B

PUR-Spiralschläuche, 95 Shore, ausziehbar auf 9 m

- Max. Betriebsdruck: 10 bar

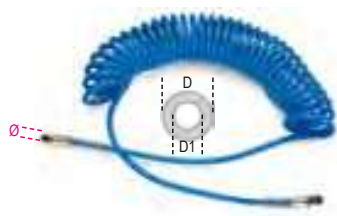

D1xD	Ø GAS	€		
mm	BSP			
6,5x10	1/4"	51,00	1	019150011
8x12	1/4"	61,00	1	019150012

1915C

PUR-Spiralschläuche, 95 Shore, ausziehbar auf 12 m

- Max. Betriebsdruck: 10 bar

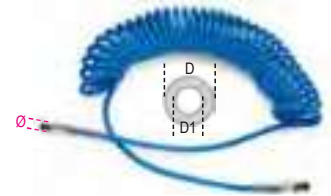

D1xD	Ø GAS	€		
mm	BSP			
6,5x10	1/4"	61,00	1	019150014
8x12	1/4"	75,00	1	019150015

1915C/L

PUR-Spiralschläuche, 95 Shore, ausziehbar auf 15 m

- Max. Betriebsdruck: 10 bar

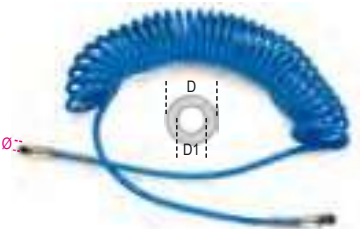

D1xD	Ø GAS	€		
mm	BSP			
8x12	1/4"	96,00	1	019150115
11x16	3/8"	163,00	1	019150116

1915D

PUR-Druckluftgewebeslauch, 95 Shore, 9 m lang

- Max. Betriebsdruck: 15 bar



D1xD	Ø GAS	€		
mm	BSP			
8x12	1/4"	61,00	1	019150017

1915E

PUR-Druckluftgewebeslauch, 95 Shore, 12 m lang

- Max. Betriebsdruck: 15 bar



D1xD	Ø GAS	€		
mm	BSP			
8x12	1/4"	80,50	1	019150019
11x16	3/8"	121,00	1	019150020

1915E/XL

PUR-Druckluftgewebespuhlen, 95 Shore, 50 m lang

• Max. Betriebsdruck: 15 bar



D1xD mm	Ø GAS BSP	€	🔧	📦
8x12	1/4"	276,00	1	019150519
11x16	3/8"	463,00	1	019150520

1916I

Stecknippel, italienische Ausführung, Außengewinde, GAS zylindrisch, BSP



Ø GAS BSP	€	🔧	📦
1/4"	3,60	5	019160001
3/8"	4,20	5	019160002

1916G

Stecknippel, europäische Ausführung, Außengewinde, GAS konisch, BSPT



Ø GAS BSPT	€	🔧	📦
1/4"	3,60	5	019160005
3/8"	4,70	5	019160010
1/2"	5,30	5	019160012

1916GF

Stecknippel, italienische Ausführung, Innengewinde, GAS zylindrisch, BSP



Ø GAS BSP	€	🔧	📦
1/4"	3,60	5	019160055
3/8"	4,20	5	019160060

1916GFE

Stecknippel, europäische Ausführung, Innengewinde, GAS konisch, BSPT



Ø GAS BSPT	€	🔧	📦
1/4"	3,60	5	019160075
3/8"	4,70	5	019160082
1/2"	5,30	5	019160084

1916JM

Stecknippel, asiatische Ausführung, Außengewinde, GAS konisch, BSPT



Ø GAS BSPT	€	🔧	📦
1/4"	5,00	1	019160406
3/8"	5,30	1	019160410

1916JF

Stecknippel, asiatische Ausführung, Innengewinde, GAS zylindrisch, BSP



Ø GAS BSP	€	🔧	📦
1/4"	5,00	1	019160456
3/8"	5,30	1	019160460

1916P

Stecknippel, italienische Ausführung, mit Gummischlauchhalteverkleidung



D1xD mm	€	🔧	📦
6x14	4,70	5	019160256
8x17	5,10	5	019160258
10x19	6,70	5	019160260

1916S

Stecknippel, italienische Ausführung, mit Spiralfeder



D1xD mm	€	🔧	📦
6x8	4,70	5	019160306
8x10	5,00	5	019160308
10x12	6,40	5	019160310

1917M

Universal-Schnellkupplungen mit Schutzgummi, Außengewinde, GAS zylindrisch, BSP

• Passend für Stecknippel Art. 1916I und Art. 1916G



Ø GAS BSP	€	🔧	📦
1/4"	12,80	5	019170001
3/8"	12,80	5	019170003
1/2"	13,50	5	019170004

1917F

Universal-Schnellkupplungen mit Schutzgummi, Innengewinde, GAS zylindrisch, BSP

• Passend für Stecknippel Art. 1916I und Art. 1916G



Ø GAS BSP	€	🔧	📦
1/4"	13,10	5	019170005
3/8"	12,80	5	019170010
1/2"	14,00	5	019170014

1917JM

Universal-Schnellkupplungen, asiatische Ausführung, Außengewinde, GAS zylindrisch, BSP



Ø GAS BSP	€	🔧	📦
1/4"	21,00	1	019170406
3/8"	21,00	1	019170410
1/2"	22,60	1	019170412

1917JF

Schnellkupplungen, asiatische Ausführung, Innengewinde, GAS zylindrisch, BSP



Ø GAS BSP	€	🔧	📦
1/4"	21,00	1	019170456
3/8"	21,00	1	019170460

1917RG

Universal-Drehkupplung

- Aus Aluminium, Innengewinde, GAS zylindrisch, BSP
- Außengewinde, zylindrisch, BSP
- Passend für alle Stecknippel italienischer und europäischer Ausführung
- Freie Drehung, auch ohne Luftanschluss



Ø GAS BSP	€	🔧	📦
1/4"	27,50	1	019170252

1917SP

Universal-Schnellkupplungen
mit Gummischlauchhalteverkleidung



D1xD mm	€	Hand	PC
6x14	13,50	5	019170206
8x17	14,10	5	019170208
10x19	16,10	5	019170210

1917ST

Universal-Schnellkupplungen
mit Spiralfeder



D1xD mm	€	Hand	PC
6x8	12,60	5	019170306
8x10	12,80	5	019170308
10x12	14,40	5	019170310

1918

Tüllanschluss, Außengewinde



D1 mm	Ø GAS BSP	€	Hand	PC
6	1/8"	2,80	3	019180106
8	1/8"	2,80	3	019180108
6	1/4"	3,20	3	019180116
8	1/4"	3,30	3	019180118
10	1/4"	3,30	3	019180120
10	3/8"	3,80	3	019180130
12	3/8"	3,90	3	019180132
10	1/2"	5,20	3	019180140
12	1/2"	5,30	3	019180142

1918N

Verbindungsrippel
mit Konusgewinde BSPT



Ø GAS	Ø1 GAS	€	Hand	PC
1/4"	1/4"	3,30	5	019180300
3/8"	3/8"	3,90	5	019180310
1/2"	1/2"	5,30	5	019180320



1918R

Reduktionsnippel mit Konusgewinde BSPT



Ø GAS	Ø1 GAS	€	Hand	PC
1/4"	3/8"	3,80	5	019180200
3/8"	1/2"	5,20	5	019180210

1919FE1/4

Wartungseinheit



Luftanschluss/Auslass	1/4" GAS BSPT
Manometergewinde	1/8" GAS BSPT
Max. Durchfluss	750 l/min
Max. Betriebsdruck	9,5 bar
Betriebsdruck	0,5 - 8,5 bar
Betriebstemperatur	5 - 60 °C
Filterschwelle	5 micron
Behälterinhalt	15 cl Luft / 25 cl Öl
Gewicht	700 g

Hand	€	PC
700	127,00	1 019190200

1919RB-FE1/4

Ersatzbehälter, 1 Paar, für Art. 1919FE1/4



Hand	€	PC
1919RB-FE1/4	27,50	1 019190210

1919RF-FE1/4

Ersatzfiltereinsatz für Art. 1919FE1/4



Hand	€	PC
1919RF-FE1/4	7,60	1 019190230

1919RM-FE1/4

Ersatzmanometer für Art. 1919FE1/4



Hand	€	PC
1919RM-FE	16,20	1 019190220

1919F1/4

Wartungseinheit



Luftanschluss/Auslass	1/4" GAS BSPT
Max. Durchfluss	1000 l/min
Max. Betriebsdruck	9,5 bar
Betriebsdruck	0,5 - 8,5 bar
Betriebstemperatur	5 - 60 °C
Filterschwelle	5 µm
Behälterinhalt	60 cl Luft / 90 cl Öl
Gewicht	1,3 kg

Hand	€	PC
1,3	199,50	1 019190250



1919F3/8

Wartungseinheit



Luftanschluss/Auslass 3/8" GAS BSPT
 Max. Durchfluss 1350 l/min
Max. Betriebsdruck 9,5 bar
 Betriebsdruck 0,5 - 8,5 bar
Betriebstemperatur 5 - 60 °C
 Filterschwelle 5 µm
Behälterinhalt 60 cl Luft / 90 cl Öl
 Gewicht 1,3 kg

kg 1,3 € 199,50 1 019190350

1919F1/2

Wartungseinheit



Luftanschluss/Auslass 1/2" GAS BSPT
 Max. Durchfluss 2500 l/min
Max. Betriebsdruck 9,5 bar
 Betriebsdruck 0,5 - 8,5 bar
Betriebstemperatur 5 - 60 °C
 Filterschwelle 5 µm
Behälterinhalt 60 cl Luft / 90 cl Öl
 Gewicht 1,3 kg

kg 1,3 € 199,50 1 019190450

1919RB-F

Ersatzbehälter, 1 Paar,
für Wartungseinheiten
Art. 1919F - 1/4", 3/8", 1/2"



1919RB-F € 35,00 1 019190510

1919RF-F

Ersatzfiltereinsatz für Wartungseinheiten
Art. 1919F - 1/4", 3/8", 1/2"



1919RF-F € 14,00 1 019190530

1919RM-F

Ersatzmanometer für Wartungseinheiten
Art. 1919F - 1/4", 3/8", 1/2"



1919RM-F € 20,90 1 019190520

1919ML

Minischmiervorrichtungen

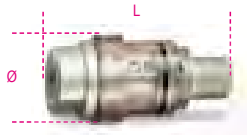

Ø	L mm	Ø mm	€	1	019190030
1/4"	63	36	26,00	1	019190030
3/8"	63	36	28,50	1	019190032

1919SC

Miniwasserabscheider

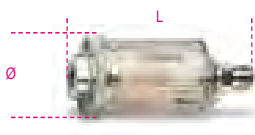

Ø	L mm	Ø mm	€	1	019190035
1/4"	80	40	33,00	1	019190035

1919L

Schmieröl ISO 32

Dichte bei 20 °C 875 Kg/m³
 Viskosität bei 40 °C 32 cSt
 Entflammbarkeit COC 210°C



cc 500 € 22,60 5 019190050



Beta



WERKSTATTEINRICHTUNGEN UND SORTIMENTE

			WERKZEUGKOFFER & WERKZEUGTROLLEYS							WERKZEUGTASCHEN												WERKZEUGTROLLEYS																	
			2009N/BV	2028/WV	2029/WV	2032/TV	2033L/WV	2036/TV	C-99	C-99V1	C-99V3/2C	C4	C5	C5S	C6T	C9MT	C7	C8	C10	C9	C10S	C11	CP15L	C16	CP17	CP17L	C12	C14	CP15	C18	C19	C19L	C20	C20L	C41S	C41H	C42H		
Stück																																							
5914VU/M	Universalsortimente	109																																					
5915VU/0	Universalsortimente	35									498																												
5915VU/1	Universalsortimente	45																																					
5915VU/2	Universalsortimente	49																																					
5915VU/3	Universalsortimente	74																																					
5915VU/4	Universalsortimente	80																																					
5915VU/5	Universalsortimente	111																																					
5915VU/AS	Universalsortimente	68																																					
5940SBK	Motorrad und Fahrradreparaturen	125																																					
5941VU/M	Universal maintenance	64																																					
5980EL/A	Elektronik	57		514		514	514																																
5980EL/B	Elektronik	98			515		515	515																															
5980ET/A	Elektrotechnik	70		512		512																																	
5980ET/B	Elektrotechnik	64			513		513	513																															
5980ID/1	Hydraulik	24	516									516																											
5980MQ	Elektrotechnik	46			513																																		
5980U/BIKE	Motorrad und Fahrradreparaturen	90																																					
5990V1	Universalsortimente	44							505	505																													
5990V3	KFZ-Mechanik	116							505		505																												

TASCHEN UND RUCKSÄCKE AUS HIGHTECH-GEWEBE

- **PRAKTISCHE NUTZUNG**
- **ROBUSTHEIT**
- **LANGE LEBENSDAUER**

Das sind die 3 Angelpunkte, um die herum sich die Produktpalette von Beta Stoffbehältnissen entwickelt.

Die Taschen und Rucksäcke von Beta sind aus widerstandsfähigem Hightech-Gewebe realisiert, sind verschleiß- und abriebfest, mit verstärktem Boden und verstärkten Nähten, um einen zuverlässigen Gebrauch auf lange Zeit zu garantieren.

Jede Tasche oder jeder Rucksack hat besondere Eigenschaften, je nach Verwendungszweck und zur Optimierung des Platzes: Taschen mit Reißverschluss, einschiebbare Griffe, Räderschutz, verstärkte Schulterriemen und durchsichtige Hüllen für Dokumente, sind nur einige der Besonderheiten jeder Tasche oder jedes Rucksacks.

Das konstante Augenmerk auf die Details, die Vielseitigkeit der Angebote und die besondere Beachtung des sicheren Transports der Werkzeuge machen diese Produkte die idealen Behältnisse unter jeder Arbeitsbedingung.

KOFFER AUS POLYPROPYLEN

Beta bietet Ihnen ein breitgefächertes Angebot an technischen Koffern für alle Ansprüche! Die Koffer und Trolleys von Beta sind aus robustem Polypropylen gefertigt und sind stoßfest, korrosionsbeständig und in der Lage, selbst beschwerlichen Nutzungsbedingungen, auch sehr niedrigen Temperaturen, stand zu halten. Wählen Sie das Produkt, das sich für Ihre Arbeit am besten eignet unter

dem klassischen Werkzeugkoffer, der Trolley-Version mit Rädern für einen leichten Transport, den Versionen mit TSA Schlössern, um frei und sicher zu reisen, und der Version aus Aluminium oder aus wasserabweisendem Material aus.

Die meisten der Koffer und Trolleys von Beta sind auch in Kombination mit Werkzeugsortimenten verfügbar, die unterschiedliche Arbeitsanforderungen erfüllen, je nach den Anwendungsgebieten: Elektronik, Hydraulik, Nautik und Wartung.



2001/B26

Werkzeugsortiment, 26teilig, mit Gewebetüte



2001/B26 € 272,00 1 020010215

55 6x7 - 8x9 - 10x11 - 12x13 - 14x15 - 16x17 mm
 96N/SC9 1,5 - 2 - 2,5 - 3 - 4 - 5 - 6 - 8 - 10 mm
 1128BMX 145 mm
 1150 180 mm
 1201E 3x75 - 4x100 - 5,5x150 mm
 1202E PH1x80 - PH2x100 mm
 1370 300 g
 1692 2 m
 1770A 9 mm

2001/BV € 63,00 1 020010051

2001/BZV

Werkzeugkoffer aus hochwiderstandsfähigem Hightech-Gewebe

- Doppelgriff oben für ein optimales Umgreifen
- Große Dokumententasche vorne mit Reißverschluss
- Klettband hinten zur Befestigung des Koffers am Griff des Trolleys
- 20 praktische Werkzeugfächer (6 Taschen und 14 Gummibänder)
- Hammerhalbtebänder
- Anbringen des Trageriemens Art. C9/RT (separat zu bestellen) möglich



2001/BZV € 58,00 1 020010151

380x290x60 mm - 675 g



2001/BZ24 MQ

Elektriker-Werkzeugsortiment, 24-teilig, im Klappkoffer



2001/BZ24 MQ € 396,00 1 020010154

	n.
1128BMX	1
1150MQ 180 mm	1
42 8-10-13-17-19 mm	5
1274MQ 3x100 - 4x100 - 5,5x125 mm	3
1272MQ PH0x60 - PH1x80 - PH2x100 mm	3
96BP/SC9 1,5-2-2,5-3-4-5-6-8-10 mm	9
1253	1
1082MQ 160 mm	1

2001/BZ27 VU

Universal-Werkzeugsortiment, 27-teilig, im Klappkoffer



2001/BZ27 VU € 321,00 1 020010157

	n.
1128BMX	1
1150 180 mm	1
42 7-8-10-13-17-19 mm	6
1201E 3x75 - 4x100 - 5,5x150 mm	3
1202E PH0x60 - PH1x80 - PH2x100 mm	3
96/SC9 1,5-2-2,5-3-4-5-6-8-10 mm	9
1370 300 g	1
1048N 250 mm	1
1692/5 5 m	1
1771 18 mm	1

2002/BV6

Werkzeugrolle aus strapazierfähigem Polyester, leer

- Mit 6 praktischen Werkzeutaschen in verschiedenen Größen
- Mittlerer Tragegriff aus verstärktem Gewebe für einen bequemen Transport
- Mit Innenklappe, die das Verlieren von Werkzeug verhindert
- Verstärkte Nähte rund um die Rolltasche
- Doppelter Klettverschluss
- Abmessungen in geöffnetem Zustand: 175 x 240 mm



2002/BV6 € 10,50 1 020020000

2002/BVL6

Werkzeugrolle aus strapazierfähigem Polyester, leer

- Mit 6 praktischen Werkzeutaschen in verschiedenen Größen
- Mittlerer Tragegriff aus verstärktem Gewebe für einen bequemen Transport
- Mit Innenklappe, die das Verlieren von Werkzeug verhindert
- Verstärkte Nähte rund um die Rolltasche
- Doppelter Klettverschluss
- Abmessungen in geöffnetem Zustand: 220 x 290 mm



2002/BVL6 € 13,40 1 020020010

2002/BV7-ZIP

Werkzeugrolle aus strapazierfähigem Polyester, leer

- Mit 7 praktischen Werkzeutaschen in verschiedenen Größen und Tasche für Kleinteile mit Reißverschluss
- Mittlerer Tragegriff aus verstärktem Gewebe für einen bequemen Transport
- Mit Innenklappe, die das Verlieren von Werkzeug verhindert
- Verstärkte Nähte rund um die Rolltasche
- Doppelter Klettverschluss
- Abmessungen in geöffnetem Zustand: 355 x 220 mm



2002/BV7-ZIP € 24,50 1 020020060

2002/BV8

Werkzeugrolle aus strapazierfähigem Polyester, leer

- Mit 8 praktischen Werkzeutaschen in verschiedenen Größen
- Mittlerer Tragegriff aus verstärktem Gewebe für einen bequemen Transport
- Mit Innenklappe, die das Verlieren von Werkzeug verhindert
- Verstärkte Nähte rund um die Rolltasche
- Doppelter Klettverschluss
- Abmessungen in geöffnetem Zustand: 395 x 360 mm



2002/BV8 € 13,40 1 020020020

2002/BV9

Werkzeugrolle aus strapazierfähigem Polyester, leer

- Mit 9 praktischen Werkzeutaschen in verschiedenen Größen
- Mittlerer Tragegriff aus verstärktem Gewebe für einen bequemen Transport
- Mit Innenklappe, die das Verlieren von Werkzeug verhindert
- Verstärkte Nähte rund um die Rolltasche
- Doppelter Klettverschluss
- Abmessungen in geöffnetem Zustand: 325 x 290 mm



2002/BV9 € 13,40 1 020020030

2002/BV12

Werkzeugrolle aus strapazierfähigem Polyester, leer

- Mit 12 praktischen Werkzeutaschen in verschiedenen Größen
- Mittlerer Tragegriff aus verstärktem Gewebe für einen bequemen Transport
- Mit Innenklappe, die das Verlieren von Werkzeug verhindert
- Verstärkte Nähte rund um die Rolltasche
- Doppelter Klettverschluss
- Abmessungen in geöffnetem Zustand: 650 x 355 mm



2002/BV12 € 21,60 1 020020040

2002/BV13

Werkzeugrolle aus strapazierfähigem Polyester, leer

- Mit 13 praktischen Werkzeugtaschen in verschiedenen Größen
- Mittlerer Tragegriff aus verstärktem Gewebe für einen bequemen Transport
- Mit Innenklappe, die das Verlieren von Werkzeug verhindert
- Verstärkte Nähte rund um die Rolltasche
- Doppelter Klettverschluss
- Abmessungen in geöffnetem Zustand: 330 x 190 mm

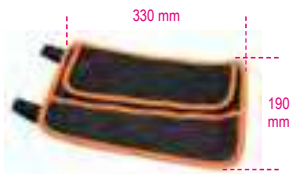

2002/BV13

€ 13,40



020020050

2002/BV42

Werkzeugrolle aus strapazierfähigem Polyester, leer

- Mit 42 praktischen Werkzeugfächern in verschiedenen Größen:
- 18 Gummibänder und 24 Taschen, davon eine mit Klappe mit Klettverschluss
- Mittlerer Tragegriff aus verstärktem Gewebe für einen bequemen Transport
- Mittels Metallringe an die Wand hängbar
- Verstärkte Nähte rund um die Rolltasche
- Robuster Verschluss mit doppelter Klippschnalle
- Abmessungen in geöffnetem Zustand: 595 x 535 mm



2002/BV42

€ 32,00



020020070

2005MPU

Werkzeugtasche leer aus Nylon, mit Gürtel

- Fünf breite Werkzeugtaschen
- Eine Fronttasche für Schere
- Schnalle mit Karabinerhaken für Klebeband
- Regulierbarer Gürtel (70 ÷ 120 cm)

Abmessungen: 155x285x80 mm



2005MPU

€ 33,50



020050060

2005MPU/E

Werkzeugtasche mit Werkzeugsortiment, 5-teilig



2005MPU/E

€ 109,00



020050065

1128BMX

1150BM 180 mm

1201E 3,5x100 - 4x100 mm

1202E PH1x80 mm

155x285x80 mm

2005PA/D

Gürteltasche, leer, aus Nylon, mit Gürtel



2005PA/D

€ 79,00



020050000

2005PA/E

Werkzeugtasche leer aus Nylon, mit Gürtel

- Zwei breite Taschen mit Gummizügen zur Aufnahme von Werkzeug
- Zwei Fronttaschen für Schere
- Zwei praktische Seitenfächer mit:
 - linke Tasche mit robustem Metallhaken für Rollbandmaß
 - rechte doppelte Tasche mit mittels Schlinge und zusätzlichem Reißverschluss schließbarem Sack
- Schnalle mit Karabinerhaken für Klebeband
- Regulierbarer Gürtel (70 ÷ 120 cm)

Abmessungen: 260x250x190 mm



2005PA/E

€ 52,50



020050030

2005PA/ET

Werkzeugtasche mit Werkzeugsortiment, 8-teilig, für Elektrotechnik



2005PA/ET

€ 214,00



020050035

1082MQ 160 160 mm

1128BMX

1253

1272MQF PH1x80 - PH2x100

1274MQF 3,5x100 - 4,5x100

1639ESB BMESB1925NE

260x250x190 mm

2005PA/S

Gürteltasche, leer, aus Nylon, mit Gürtel



2005PA/S

€ 39,50



020050020

2009N/BV

Wartungstasche aus Leder



2009N/BV

€ 333,00



020090200

530x220x190 mm

2005PA/U

Werkzeugtasche mit Werkzeugsortiment,
17-teilig, für Universalegebrauch



2005PA/U € 206,00 1 020050040

96/SC9

111E 200 mm

1048N 250 mm

1128BMX

1201E 4x100 - 5,5x125 mm

1202E PH1x80 - PH2x100 mm

1692/3 3 m

≡ 260x250x190 mm

2028/VV

Werkzeugkoffer aus Polypropylen

2 Werkzeugtafeln
Interner Boden mit herausnehmbaren Innenteilern
Doppelverschluss mit Kombination



2028/VV € 275,00 1 020280010

≡ 480x190x400 mm

2028E

Werkzeugsortiment für Elektroniker und
Elektrotechniker, im Werkzeugkoffer



2028EL/A € 1.355,00 1 020281014
(2028/VV+5980EL/A)

2028ET/A € 1.365,00 1 020281018
(2028/VV+5980ET/A)

2029/VV

Werkzeugkoffer aus hochfestem Polypropylen,
mit Aluprofilen

2 Werkzeugpaneele
Boden mit herausnehmbaren und verstellbaren Innenteilern
Geliefert mit Tragegurt
2 Schlüsselschlösser



2029/VV € 394,00 1 020290000

≡ 480x227x408 mm

2029E

Werkzeugsortimente für Elektroniker
und Elektrotechniker, im Werkzeugkoffer



2029 BG MQ € 2.425,00 1 020291257
(2029/VV+5980MQ)

2029ET/B € 1.900,00 1 020291021
(2029/VV+5980ET/B)

2029EL/B € 1.920,00 1 020291017
(2029/VV+5980EL/B)

2029EM

Werkzeugsortimente für die Wartung und
Reparatur von Hybrid- und Elektrofahrzeugen,
im Koffer



2029EM € 2.445,00 1 020290300

52MQ 7-8-9-10-11-12-13-14-15-16-17-19-22 mm

910MQ/B 6-7-10-12-13-17-19 mm

910MQ/TX TX25 - TX30 - TX40

910MQ/55

1048MQ 250 mm

1082MQ 160 mm

1128MQ 145 mm

1150MQ 180 mm

1162MQ 160 mm

1272MQ PH1 - PH2

1274MQ 2,5x75 - 3x100 - 4x100 - 5,5x125 - 6,5x150 mm

1760PT

1777MQ/U 190 mm

1996MQ/GM GM 10

7109A A1 - A2

7109D D2 - D3

2032/TV

Werkzeugrolley aus Kunststoff

2 Werkzeugpaneele
Werkzeugtasche
Interner Boden mit herausnehmbaren Trennwänden



2032/TV € 533,00 1 020320110

≡ 450x200x400 mm



2032/TE

Werkzeugsortimente für Elektroniker und Elektrotechniker, im Werkzeugrolley



2032TET/A
(2032/TV+5980ET/A) € 1.625,00 1 020321328

2033L/VV

Werkzeugkoffer aus Aluminium, leer

- Äußerst stoßfest
- Kratzfeste Oberfläche
- Ergonomischer Gummigriff
- Doppelschloss mit Kombination
- 2 Werkzeugtafeln mit Gummibändern
- Interner Boden mit herausnehmbaren Trennwänden



2033L/VV € 431,00 1 020330250
470x203x373 mm

2033L

Werkzeugsortimente für Elektroniker und Elektrotechniker, im Alu-Werkzeugkoffer



2033LEL/A € 1.515,00 1 020331224
(2033L/VV+5980EL/A)

2033LEL/B € 1.955,00 1 020331225
(2033L/VV+5980EL/B)

2033LET/B € 1.935,00 1 020331237
(2033L/VV+5980ET/B)

2036/TV

Werkzeugtrolley aus dick strukturiertem Polypropylen, Aluminiumprofil

- 2 Werkzeugpaneele
- Teleskopgriff
- Räder mit Kugellagern



2036/TV € 625,00 1 020360000
480x267x408 mm

2036E

Werkzeugsortimente für Elektroniker und Elektrotechniker, im Werkzeugwagen



2036TET/B € 2.125,00 1 020361223
(2036/TV+5980ET/B)

2036EL/B € 2.145,00 1 020361218
(2036/TV+5980EL/B)

2037/TV

Werkzeugtrolley aus dickem Polypropylen mit 4 Laufrollen

- Extrem stoßfest. Geeignet für den Transport von Werkzeug im Flugzeug.
- 2 Werkzeugaufnahmeplatten, entfernbar.
- Integrierte Dokumententasche.
- 4 entfernbar Laufrollen, welche das horizontale Bewegen des Trolleys erlauben.
- 2 Aufnahmeschalen für Kleinteile
- 2 TSA-Schlösser mit Schlüssel
- Ergonomischer Handgriff mit Gummiverkleidung



2037/TV € 771,00 1 020370000
482x295x478 mm

2038/TV

Werkzeugtrolley aus dick strukturiertem Polypropylen

- Extrem stoßfest.
- Alu-Dichtprofil
- 2 homologierte TSA-Schlösser mit Schlüssel
- 2 entnehmbare Werkzeugaufnahmeplatten.
- Teleskopgriff und große Räder mit Kugellager
- 2 ergonomische Griffe (1 seitlich), gummiverkleidet
- Großräumiger Boden
- Dokumententasche
- 3 Kleinteile-Schubladen



2038/TV € 1.018,00 1 020380000
430x375x525 mm



2041UC

Werkzeugsortiment, 33teilig, im Werkzeugkoffer "Utility Case"



2041UC € 407,00 1 020410215

- 55 6x7 - 8x9 - 10x11 - 12x13 - 14x15 - 16x17 mm
- 96/SC9 1,5 - 2 - 2,5 - 3 - 4 - 5 - 6 - 8 - 10 mm
- 111E 200 mm
- 1048VN 250 mm
- 1128BMX 145 mm
- 1150 180 mm
- 1201E 2,5x50 - 3x75 - 4x100 - 5,5x100 - 6,5x150 mm
- 1202E PH0x60 - PH1x80 - PH2x100 mm
- 1370 300 g
- 1692 3m
- 1771 170 mm
- 1833S 70 Lumen / 140 mm
- 1639NS-N 25m
- 1696 200 mm

≡ 535x282x87 mm - 📦 4,5 Kg

2051N

Werkzeugsortiment, 55teilig, für die Schiffswartung, im stoßfesten PP-Koffer



2051N € 961,00 1 020510225

- 42 7 - 8 - 10 - 12 - 13 - 14 - 17 - 19 mm
- 55AS 3/8x7/16 - 1/2x9/16 - 5/8x11/16"
- 96/SC9 \varnothing 1,5+10 mm
- 111E 200 mm
- 920A \varnothing 10 - 12 - 13 - 14 - 17 - 19 mm
- 920AS \varnothing 7/16 - 1/2 - 9/16 - 11/16 - 7/8"
- 920/22 255 mm - \square 1/2 - \blacksquare 1/2
- 920/25 \square 1/2 - \blacksquare 1/2
- 920/42 \blacksquare 1/2
- 920/55 \blacksquare 1/2
- 956C \square 1/2 - 16 - 20,8 mm
- 1048BM 250 mm
- 1084BM 160 mm
- 1128BMX 145 mm
- 1150BM 180 mm
- 1166BM 160 mm
- 1201E \bullet 3x75 - 4x100 - 5,5x150 - 6,5x150 mm
- 1202E \oplus PH1x80 - PH2x100 mm
- 1390 \varnothing 35 mm
- 1490/2 \varnothing max 240 mm
- 1737 145 mm
- 1778X
- BMN1436 3,6 x 140 mm
- BMESB1925NE 25 m

≡ 585x393x92 mm - 📦 9 kg

2055HB

Werkzeugsortiment, 24teilig, im Werkzeugkoffer "Home Bag"



2055HB € 245,00 1 020550215

- 55 6x7 - 8x9 - 10x11 - 12x13 mm
- 96N/SC9 1,5 - 2 - 2,5 - 3 - 4 - 5 - 6 - 8 - 10 mm
- 1128BMX 145 mm
- 1150 180 mm
- 1048VN 250 mm
- 1201E 3x75 - 4x100 - 5,5x100 mm
- 1202E PH0x60 - PH1x80 - PH2x100 mm
- 1370 300 g
- 1692 3m

≡ 373x275x70 mm - 📦 3 Kg

2080/V6

Werkzeugkoffer mit 6 ausziehbaren Behältern und verstellbaren Trennwänden



2080/V6 mm € 46,00 1 020800060

2080/V6-U

Ausziehbarer Behälter für Werkzeugkoffer Art. 2080/V6



2080/V6-U € 3,60 1 020800066

≡ 90x60x50 mm

2080/D10

Satz mit 10 verstellbaren Trennwänden, für Werkzeugkoffer Art. 2080/V6



2080/D10 € 9,20 1 020800070

2080/V12

Werkzeugkoffer mit 12 ausziehbaren Behältern



2080/V12 mm € 71,00 1 020800000

2080/V12-...

Ausziehbarer Behälter für Werkzeugkoffer Art. 2080/V12



2080/V12-S € 4,50 3 020800013

2080/V12-M € 6,60 2 020800015

2080/V12-L € 11,50 1 020800020

≡ 295x75x65 mm

C3

Mini-Werkzeugtasche aus Hightech-Gewebe

Haupteigenschaften:

- 1 Außentasche vorne mit Reißverschluss
- 2 Seitentaschen komplett mit Aufnahmeschalen für Kleinteile
- 1 praktische Tasche hinten mit Klettverschluss
- 1 herausnehmbares internes Werkzeugpaneel, mit Gummibändern auf beiden Seiten
- USB-Schnittstelle zum Aufladen der eigenen mobilen Geräte
- Inklusive Trageriemen



C3 € 76,00 1 021030000

≡ 230x110x320 mm - 890 g

C4 - 2104

Werkzeugbeutel aus High-Tech Gewebe

- Herausnehmbares internes Werkzeugpaneel
- Taschen und Gummibänder zum Unterbringen des Werkzeugs, innen und außen
- Steifer Boden, wasserundurchlässig, mit Gummifüßchen
- Lieferung mit Schulterriemen



C4 € 129,00 1 021040000
2104VU/0 € 595,00 1 021041122

≡ 330x260x360 mm - 2,5 kg

C5S

Werkzeurgucksack aus widerstandsfähigem Polyester

- Doppelgriff oben in der Mitte des Rucksacks für einen sicheren und ausgewogenen Griff
- Zwei große Fronttaschen
- Zwei geräumige Innentaschen und 2 zusätzliche Klettbänder
- Praktische auf-/einrollbare Innentasche, bestehend aus 4 Werkzeugtafeln
- Verstellbare verstärkte Schulterriemen
- Maximale Tragfähigkeit: 15 kg



C5S € 65,50 1 021050100

≡ 310x120x390 mm - 0,9 Kg

C5 - 2105

Werkzeurgucksack aus Hightech-Gewebe



C5 € 183,00 1 021050000
2105VU/0 € 650,00 1 021051122

≡ 400x200x500 mm - 2,5 Kg

C6T - 2106

Werkzeurgucksack aus Hightech-Gewebe, mit Rollen



C6T € 260,00 1 021060010
2106T/VU0 € 727,00 1 021061123

≡ 360x200x480 mm - 4,5 kg

C7 - 2107

Werkzeugtasche aus High-Tech-Gewebe

- 2 herausnehmbare interne Werkzeugpaneele
- Interne Notebook-Tasche
- 2 Außentaschen vorne
- Interner Boden aus Kunststoff mit herausnehmbaren Trennwänden



C7 € 271,00 1 021070000
2107VU/2 € 764,00 1 021071112

2107VU/3 € 1.320,00 1 021071114

≡ 480x165x380 mm - 3,5 kg

C7AT

Service Tasche aus technischem Gewebe

Hauptmerkmale:

- Aus hochfestem technischem Gewebe
- Verstärkter Boden mit Gummifüßchen
- Doppelter Griff für einen ausgewogenen und sicheren Halt
- Großes Dokumentenfach vorne mit Reißverschluss und zusätzliches Fach mit doppeltem Klettverschluss + Clip
- Doppelte Seitentasche mit Klettverschluss
- Geräumiges Innenfach mit zusätzlichem Dokumentenfach
- PC- und Tablet-Fach mit innenliegender Schutzpolsterung (PC-Größe bis L = 370 mm, H = 250 mm)
- Frontöffnung mit Reißverschluss auf beiden Seiten der Tasche für schnellen Zugriff auf die Werkzeuge:
- 29 Fächer und 13 elastische Werkzeugschlaufen auf der Vorderseite;
- 33 Werkzeugfächer auf der Rückseite.
- Komplett mit gepolstertem, verstellbarem Schultergurt



C7AT

€ 146,00 1 021070010

≡ 470x200x340 mm

C8 - 2108

Werkzeugtrolley aus Hightech-Gewebe



C8 306,00 1 021080000
 2108VU/1 873,00 1 021081022

≡ 470x280x380 mm - 4 kg

C8B

Werkzeugtrolley aus Hightech-Gewebe, für Elektriker

Steife Struktur

Teleskopgriff für den Transport

4 Laufrollen

1 herausnehmbares internes Werkzeugpaneel

Fronttasche mit Badge-Einsatz

Doppelter Boden mit Aufnahmeschale für Kleinteile (im Lieferumfang inbegriffen)

2 seitliche Außentaschen

2 Einziehbandhaken

Kippgriff für einen leichten Zugang zu den Werkzeugen

Ausgelegt für das Verschließen mit Schloss (im Lieferumfang nicht inbegriffen)



C8B

€ 247,00 1 021080300

≡ 380x250x430 mm - 4,7 kg

C9 - 2109

Werkzeugtasche aus High-Tech Gewebe

- Steifer Boden
- Innen- und Außentaschen zur Unterbringung von Werkzeug
- Außentasche mit Reißverschluss für mehr Sicherheit
- Mit Klettverschluss verschließbare Tasche für persönliche Gegenstände
- Doppelter Boden
- Doppelriemen für Wasserwaagen
- Schulterriemen für einen einfacheren Transport



C9

€ 148,00 1 021090000

2109VU/1 715,00 1 021091022

2109VU/3 1.196,00 1 021091024

≡ 550x280x320 mm - 2,6 kg

C9/RT

Schulterriemen für Art. C9 und Art. C10



C9/RT

€ 19,30 1 021090900

C9DA

Werkzeugtasche, weit zu öffnend

Hauptmerkmale:

- Aus hochfestem technischem Gewebe
- Stabiler, wasserfester Kunststoffboden
- Verstärkter oberer Griff für sicheren Halt
- Doppelte Seitentasche mit Klettverschluss
- Zwei weit öffnende seitliche Werkzeugfächer für schnellen Zugriff und perfekte Sicht auf den Inhalt
- 22 Werkzeugtaschen und zusätzliches Reißverschlussfach auf der Vorderseite
- 14 Werkzeugtaschen und zusätzliches Reißverschlussfach auf der Rückseite
- Komplett mit gepolstertem, verstellbarem Schultergurt



C9DA

€ 118,00 1 021090005

≡ 420x220x310 mm



C9MT

Werkzeugtasche für Wartungspersonal

- Strapazierfähiger PVC-Außenmantel, wasserdicht
- Umlaufend verstärkte Nähte
- Doppelter Schnallenverschluss
- Doppelter Innengriff für einen ausgewogenen und sicheren Halt
- Reißverschlusstasche für Dokumente



C9MT € 104,00 1 021090200

450x180x200 mm

2109MT ID/1

Werkzeugtasche für Wartungspersonal, mit Hydraulikwerkzeugsortiment, 24-teilig



2109MT ID/1 € 735,00 1 021091026
(C9MT+5980ID/1)

- 111E 250 mm
- 332 Ø 3+28 mm
- 334 Ø 3+30 mm
- 342 Ø 0+42 mm
- 345SB2 140 mm
- 376 320-410 mm
- 1048N 175-250 mm
- 1128BMX
- 1150GBM 180 mm
- 1201E 3x75-4x100-5,5x150-8x150 mm
- 1202E PH1x80-PH2x100
- 1370 500 g
- 1690F 2 m
- 1692/5 5 m
- 1696 200 mm
- 1719BMA...M 200 mm
- 1719BM/RL 200 mm
- 1725

Beta

C9PT



C9PT 321

C10 - 2110

Werkzeugtasche aus High-Tech Gewebe

- Steife Struktur
- Doppelter Boden. Der Boden kann entfernt werden, um das Fassungsvermögen der Tasche zu erhöhen
- Klippbarer bzw. schräg verstellbarer Griff für einen leichten Zugang zu den Werkzeugen
- Gummibänder zur Aufnahme von Werkzeug sowie Innen- und Außentaschen
- Futter
- Schale zur Aufnahme von Kleinteilen im Doppelboden



C10 € 186,00 1 021100000
2110VU/1 € 752,00 1 021101031
(C10+5915VU/1)
2110VU/3 € 1.235,00 1 021101034
(C10+5915VU/3)
2110VU/AS € 1.335,00 1 021101036
(C10+5915VU/AS)

520x220x250 mm - 3,3 kg

C10S - 2110S

Werkzeugtasche aus High-Tech Gewebe

- Steifer Boden
- Doppelter Boden. Der Boden kann entfernt werden, um das Fassungsvermögen der Tasche zu erhöhen
- Klippbarer bzw. schräg verstellbarer Griff für einen leichten Zugang zu den Werkzeugen
- Gummibänder zur Aufnahme von Werkzeug sowie Innen- und Außentaschen
- Futter
- Schale zur Aufnahme von Kleinteilen im Doppelboden



C10S € 147,00 1 021100001
2110SVU/1 € 713,00 1 021101041
(C10S+5915VU/1)
2110SVU/3 € 1.195,00 1 021101044
(C10S+5915VU/3)

420x220x250 mm - 2,3 kg

C11 - 2111

Werkzeugkasten aus Stoff



C11 € 109,00 1 021110000
2111VU/1 € 675,00 1 021111031
(C11+5915VU/1)
2111VU/3 € 1.157,00 1 021111034
(C11+5915VU/3)

410x230x250 mm - 2 kg

Beta



C12 - 2112

Werkzeugtasche aus High-Tech-Gewebe

Herausnehmbares internes Werkzeugpaneel
Gummibänder zur Aufnahme von Werkzeug sowie große Innen- und Außentaschen
Die Tasche öffnet sich vorne, um am Arbeitsplatz leicht an die Werkzeug heranzukommen
Wasserundurchlässige Basis mit Gummifüßchen
Kann auch mit Trolley C8 benutzt werden



	€		
C12	235,00	1	021120000
2112ET/A (C12+5980ET/A)	1.330,00	1	021121028
2112ET/B (C12+5980ET/B)	1.735,00	1	021121029
2112VU/5 (C12+5915VU/5)	1.565,00	1	021121056

≡ 500x270x350 mm - 5 kg

C13

Werkzeugtrolley, aus hochwiderstandsfähigem Polypropylen

- Geeignet für Gebrauch im Freien
- Stoßfest und chemikalienbeständig
- Vorbereitung mit Schlossverschluss (nicht inklusive)
- Mit zwei Verschlüssen
- Zwei Räder zum horizontalen Handling des Werkzeugtrolleys
- Mit herausnehmbarer Schale zur Aufnahme von Kleinteilen, auf 2 Lagen verstellbar
- Namensschild



	€		
C13	389,00	1	021130000

≡ 806x350x467 mm - 7,2 kg

C14

Werkzeugtrolley aus Polypropylen mit 4 Schubladen

- Aufbau aus eingespritztem Polypropylen, der eine hohe Stoßfestigkeit garantiert.
- Das Vorderteil, geschützt durch Frontabdeckung, enthält 4 ausziehbare Schubladen 470x255 mm:
1 Schublade Höhe 30 mm
2 Schubladen Höhe 60 mm
1 Schublade Höhe 90 mm
- Die frontale Zentralverriegelung ermöglicht, die obere und die vordere Abdeckung gleichzeitig zu schließen
- Zwei seitliche Griffe
- 4 robuste Hinterräder
- Abnehmbare obere Schale
- Werkzeughaltepaneel in der Abdeckung integriert
- 3 mitgelieferte Kleinteile-Ablegesohlen
- Namensschild
- Ausgelegt für das Verschließen mit TSA Schloss



	€		
C14	992,00	1	021140000
2114VU/M (C14+5914VU/M)	2.250,00	1	021141011

≡ 585x390x457 mm - 10 kg

CP15 - 2115

Werkzeugkasten aus Kunststoff mit herausnehmbaren Behälter und Schale für Kleinteile

- 1 Schale für Kleinteile, im Deckel integriert
- 2 herausnehmbare Schalen für Kleinteile mit verstellbaren Trennwänden
- 1 interner Behälter mit verstellbaren Trennwänden



	€		
CP15	57,50	1	021150201
2115PVU/1 (CP15+5915VU/1)	624,00	1	021151232
2115PVU/2 (CP15+5915VU/2)	551,00	1	021151234

≡ 445x240x250 mm - 2 kg

CP15L - 2115

Werkzeugkasten, lange Ausführung, aus Kunststoff mit herausnehmbaren Behälter und Schale für Kleinteile

- 3 Schalen für Kleinteile im Deckel integriert mit verstellbaren Trennwänden
- 1 interner Behälter mit Trennwänden



	€		
CP15L	78,00	1	021150202
2115PL-VU/1 (CP15L+5915VU/1)	645,00	1	021151242
2115PL-VU/3 (CP15L+5915VU/3)	1.127,00	1	021151245

558x277x270 mm - 2,5 kg

2115PI/BIKE-HOME

Werkzeugsortiment, 28-teilig

Fahrradreparaturen



	€		
2115PI/BIKE-HOME	314,00	1	021150098

96BP/SC9

3935

3969K3

42 8-9-10-13-14 mm

42SLIM 15 mm

1082G 160 mm

1150G 180 mm

1201E 3x75 - 5,5x150 mm

1202E PH0x60 - PH2x100 mm

3991

BMESB1925NE 25 mm

BMN1436 3,6 x 140 mm

558x277x270 mm - 4,3 kg





2115P L-MQ32

Werkzeugsortiment, 32 isolierte Werkzeuge für Hybridautos, in Kunststoffwerkzeugkoffer mit Schaumeinsatz



2115PL-MQ32 € 1.395,00 1 021150332

- 920MQ/55A
- 89MQ 10-12 mm
- 850MQ 1/4"
- 860TX/A10 T7-T8-T9-T10-T15-T20-T25-T27-T30-T40
- 920MQ/A 8-10-12-13-14-17-19 mm
- 920MQ/21 125mm
- 920MQ/22 250mm
- 1048MQ250 250mm
- 1150MQ 180mm
- 1164MQ160 160mm
- 1272MQ 4.5X80-6X100mm
- 1274MQ 3X100-4X100-5.5X125
- 1995MQ/G2
- CP15L

C16 - 2116

Werkzeugkasten aus Stoff mit internem Aufbewahrungsfach, leer



C16 € 128,00 1 021160000
2116VU/1 € 694,00 1 021161102 (C16+5915VU/1)
2116VU/3 € 1.176,00 1 021161105 (C16+5915VU/3)
 ≡ 500x260x260 mm - 2,5 kg

CP17 - CP17L - 2117

Werkzeugkasten aus Edelstahl und Kunststoff, mit Einsatz



CP17 € 108,00 1 021170500
2117P-VU/1 € 674,00 1 021171042 (CP17+5915VU/1)
2117P-VU/3 € 1.156,00 1 021171045 (CP17+5915VU/3)
CP17L € 154,00 1 021170502
2117L-VU/1 € 721,00 1 021171142 (CP17L+5915VU/1)
2117PL-VU/3 € 1.205,00 1 021171145 (CP17L+5915VU/3)

C18 - 2118

Werkzeugkasten, einfach aus Stahlblech



C18 € 51,00 1 021180001
2118VU/1 € 617,00 1 021181032 (C18+5915VU/1)
 ≡ 450x200x100 mm - 3 kg

C19 - 2119 - C19L - 2119L

Werkzeugkasten, ausklappbar, mit drei Fächern, aus Stahlblech



C19 € 67,00 1 021190001
2119VU/3 € 1.115,00 1 021191025 (C19+5915VU/3)
C19L € 86,00 1 021190002
2119L-VU/3 € 1.134,00 1 021191125 (C19L+5915VU/3)

C20 - C20L - 2120

Werkzeugkasten, ausklappbar, mit fünf Fächern, aus Stahlblech



C20 € 94,50 1 021200001
2120VU/2 € 588,00 1 021201061 (C20+5915VU/2)
2120VU/3 € 1.143,00 1 021201063 (C20+5915VU/3)
2120VU/4 € 1.450,00 1 021201064 (C20+5915VU/4)
2120VU/AS € 1.245,00 1 021201068 (C20+5915VU/AS)
C20L € 103,50 1 021200002
2120L-VU/2 € 597,00 1 021201161 (C20L+5915VU/2)
2120L-VU/3 € 1.152,00 1 021201163 (C20L+5915VU/3)
2120L-VU/4 € 1.460,00 1 021201164 (C20L+5915VU/4)
2120L-VU/AS € 1.255,00 1 021201168 (C20L+5915VU/AS)



C20TSS

Werkzeugkasten, ausklappbar, mit fünf Fächern, aus Edelstahl AISI 304



C20TSS € 346,00 1 021203001

≡: 450x200x210 mm - 4kg

C22B

Werkzeugkasten aus Stahlblech



C22B O
≡: 720x320x310 mm

C22BM O
≡: 850x360x350 mm

C22BL O
≡: 1010x410x400 mm

C22B-O	€ 268,00	1	022000150
C22BM-O	€ 308,00	1	022000160
C22BL-O	€ 411,00	1	022000170

C22B O: 13 kg
C22BM O: 20 kg
C22BL O: 26 kg

C22W

Werkzeugkoffer aus Blech, zum Schutz der Werkzeuge mit Innenverkleidung



C22W-O
≡: 690x300x360 mm

C22WL-O
≡: 990x300x360 mm

C22W-O	€ 298,00	1	022000269
C22WL-O	€ 388,00	1	022000299

C22W O: 15 kg
C22WL O: 28 kg

C22P

Werkzeugkasten für Baustellen, aus Blech

Versenkbare Griffe
Erhöhte Gleitbacken für das Anheben mit Gabelstapler
Diebstahlsichere Doppelverriegelung für Schloss (nicht inklusive)



C22PM O
≡: 915x540x430 mm

C22PL O
≡: 1220x720x615 mm

C22PM-O	€ 798,00	1	022000240
C22PL-O	€ 1.230,00	1	022000245

C22PM O: 39 kg
C22PL O: 67 kg





C99

Combo ist das modulare System von Beta, bestehend aus 3 verschiedenen robusten Werkzeugkoffern, um Ihre Arbeitsausrüstung ordentlich und sicher zu verwahren. Die Koffer können dank des praktischen Seitenschließsystems mit einem einfachen Klick, miteinander verbunden werden.

Das System Beta Combo C99 ist kompatibel mit dem Standard L-BOXX di Sortimo®

C99

Komplettes Modulsystem BETA COMBO

Die Werkzeugkoffer können dank des praktischen Seitenschließsystems mit einem einfachen Klick miteinander verbunden werden.

Bestehend aus:

- Ultrakompakter zusammenklappbarer Wagen mit Teleskopstiel Art. C99P (485x520x1095 mm)
- Werkzeugkoffer aus ABS C99V1 (445x358x152 mm)
- Werkzeugkoffer aus ABS C99V2 (445x358x254 mm)
- Werkzeugkoffer aus ABS mit 2 transportierbaren Kleinteilkästen Art. C99V3/2C (445x358x322 mm)



C99 € 785,00 1 099000010

C99V0

Werkzeugkoffer COMBO aus ABS, mit transparentem Deckel

Die Werkzeugkoffer können dank des praktischen Seitenschließsystems mit einem einfachen Klick miteinander verbunden werden.

Haupteigenschaften:

- Transparenter Deckel aus robustem Polycarbonat zur schnellen Identifizierung des Inhalts
- Außenabmessungen: 445x358x118 mm
- Max. Traglast intern: 25 Kg
- Vorbereitung für Schlossverschluss
- Gewicht: 2.5 kg

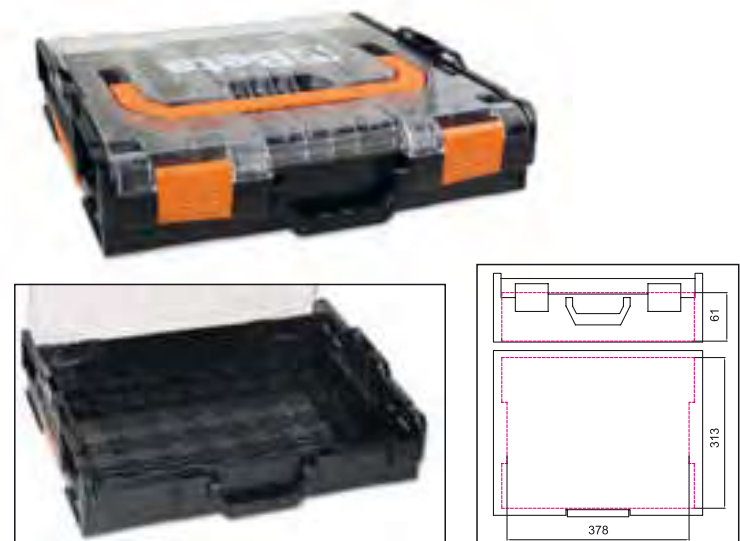

C99V0 € 125,00 1 099000202

C99V0-P12

Werkzeugkoffer COMBO aus ABS, mit transparentem Deckel

Die Werkzeugkoffer können dank des praktischen Seitenschließsystems mit einem einfachen Klick miteinander verbunden werden.

Haupteigenschaften:

- Transparenter Deckel aus robustem Polycarbonat zur schnellen Identifizierung des Inhalts
- Besonders geeignet für den Transport von Kleinteilen, wie z. B. Schrauben, Muttern, Unterlegscheiben, Nieten und Dübeln
- Geliefert mit Kit mit 18 Aufnahmeschalen für Kleinteile:
 - 2 rote Aufnahmeschalen 52x52 mm
 - 3 gelbe Aufnahmeschalen 104x52 mm
 - 2 blaue Aufnahmeschalen 104x104 mm
 - 1 grüne Aufnahmeschale 104x156 mm
 - 2 orangefarbene Aufnahmeschalen 208x52 mm
 - 2 graue Aufnahmeschalen 312x71 mm und 6 verstellbare Trennwänden
- Außenabmessungen: 445x358x118 mm
- Max. Traglast intern: 25 kg
- Vorbereitung für Schlossverschluss
- Gewicht: 3,2 kg

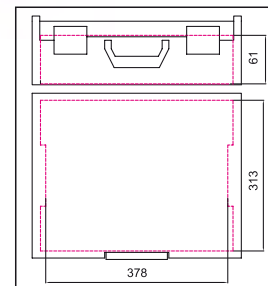

C99V0-P12

€ 178,00 1 099000200

C99P12-V0

Kit mit 18 Aufnahmeschalen für Kleinteile für Werkzeugkoffer Art. C99V0

Inhalt:

- 2 rote Schalen 52x52 mm
- 3 gelbe Schalen 104x52 mm
- 2 blaue Schalen 104x104 mm
- 1 grüne Schale 104x156 mm
- 2 orangefarbene Schalen 208x52 mm
- 2 graue Schalen 312x71 mm und 6 verstellbare Trennelemente



C99P12-V0

€ 55,50 1 099000499

C99V1

Werkzeugkoffer COMBO aus ABS

Die Werkzeugkoffer können dank des praktischen Seitenschließsystems mit einem einfachen Klick miteinander verbunden werden.

Haupteigenschaften:

- Außenabmessungen: 445x358x152 mm
- Max. Traglast intern: 25 kg
- Vorbereitung für Schlossverschluss
- Gewicht: 2,2 kg

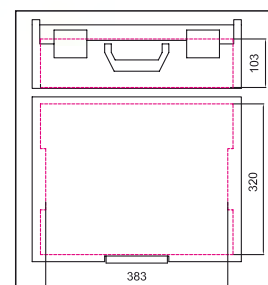

C99V1

€ 126,50 1 099000250

C99V2

Werkzeugkoffer COMBO aus ABS

Die Werkzeugkoffer können dank des praktischen Seitenschließsystems mit einem einfachen Klick miteinander verbunden werden.

Haupteigenschaften:

- Außenabmessungen: 445x358x254 mm
- Max. Traglast intern: 25 kg
- Gewicht: 2,8 kg

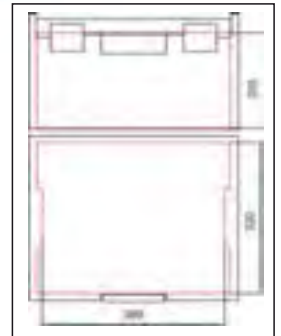

C99V2

€ 141,50 1 099000350

C99V3/2C

Werkzeugkoffer COMBO aus ABS mit 2 transportierbaren Kleinteilkästen

Die Werkzeugkoffer können dank des praktischen Seitenschließsystems mit einem einfachen Klick miteinander verbunden werden.

Haupteigenschaften:

- Außenabmessungen: 445x358x322 mm
- Max. Traglast intern: 25 kg
- Geliefert mit 2 Kleinteilkästen Art. C99C-V3, leer
- Gewicht: 5,6 kg

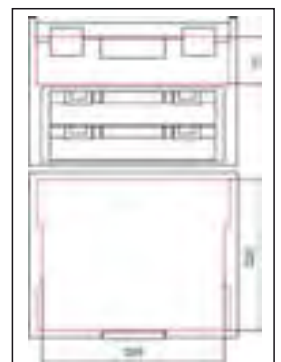
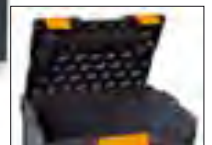

C99V3/2C

€ 271,00 1 099000450

C99C-V3

Werkzeugkasten COMBO, transportierbar

Transparenter Deckel für eine schnelle Erkennung des Inhalts
Integrierter Griff
Außenabmessungen: 367x316x72 mm
Gewicht: 0,9 kg

Mögliche Ausrüstung mit:

- Thermoformateinsatz für Kleinteile mit 7 Fächern Art. C99T-V3
- Kit mit 17 Aufnahmeschalen für K

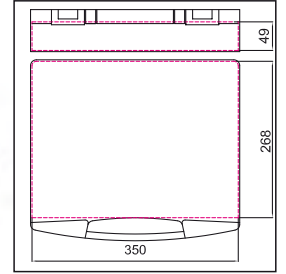

C99C-V3

€ 45,50 1 099000496

C99P

Klappwagen COMBO

Haupteigenschaften:

- Ultrakompakter zusammenklappbarer Wagen
- Griff mit Teleskopstiel
- Abmessungen offen: 485x520x1095 mm
- Abmessungen geschlossen: 485x80x810 mm
- Abmessungen klappbare Basis 485x350 mm
- Zwei unplattbare L



C99P

€ 245,00 1 099000101

C99PC

Innenverkleidung für Deckel der Werkzeugkoffer Art. C99V1 und Art. C99V3/2C

Unverzichtbar in Kombination mit den Thermoformateinsätzen, um zu vermeiden, dass der Inhalt aus den Fächern herausfällt oder sich während dem Transport durcheinandergeworfen wird.



C99PC

400x320x20 mm

€ 21,60 1 099000491

C99PP

Werkzeugpaneel für Werkzeugkoffer COMBO

- Mit 6 Taschen und 11 Gummibändern zur Aufnahme von Werkzeug
- Komplett mit Haken zur Befestigung des Panels in den Kofferdeckel



306 mm

376 mm

C99PP

€ 58,50 1 099000489



RSC22

Werkzeugkasten
mit 3 Schubladen

Haupteigenschaften:

- 3 Schubladen mit Teleskopführungen, kugelgelagert, 588x277 mm:
- 1 Schublade Höhe 50 mm
- 2 Schubladen Höhe 70 mm.
- Zentralverriegelung mit vorderem Schloss.
- Versenkbare Seitengriffe zum bequemen Tragen.

19 kg



RSC22-O



RSC22-A



RSC22-R



h	max
50 mm	25 kg
70 mm	25 kg

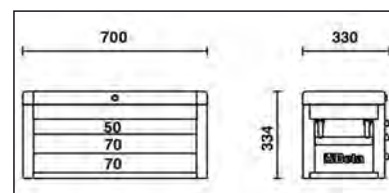
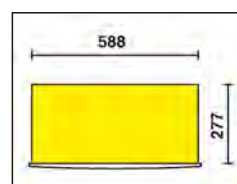

		€	1	1
RSC22-O	RAL 2011	552,00	1	022003001
RSC22-R	RAL 3000	552,00	1	022003003
RSC22-A	RAL 7016	522,00	1	022003007

RSC23

Werkzeugkasten
mit 5 Schubladen

Haupteigenschaften:

- 5 Schubladen mit Teleskopführungen, kugelgelagert, 588x277 mm:
- 2 Schubladen Höhe 50 mm
- 3 Schubladen Höhe 70 mm.
- Zentralverriegelung mit vorderem Schloss.
- Versenkbare Seitengriffe zum bequemen Tragen.

📦 26 kg



h	max
50 mm	25 kg
70 mm	25 kg

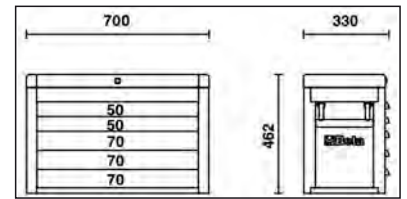
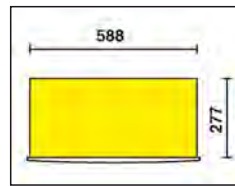

		€	📦	🚚
RSC23-O	RAL 2011	700,00	1	023003001
RSC23-R	RAL 3000	700,00	1	023003003
RSC23-A	RAL 7016	700,00	1	023003007

CD23S

Transportwagen Caddy

Haupteigenschaften:

- Mit ABS bezogene Arbeitsplatte, auf die die Werkzeugkästen C22S, C23S, C23SC und C23ST aufgesetzt werden können
- Die Deichsel kann abmontiert und unter dem Wagen gelagert werden.
- Vier Räder Ø 100 mm: 2 starre und 2 lenkbare (davon 1 gebremst).
- Maximale Tragfähigkeit: 250 kg.

📦 14 kg



	€	📦	🚚
CD23S	322,00	1	023000610

RSC23C

Werkzeugkasten
mit 8 Schubladen

Haupteigenschaften:

- 8 Schubladen mit Teleskopführungen, kugelgelagert, 588x277 mm:
- 4 Schubladen Höhe 50 mm
- 3 Schubladen Höhe 70 mm
- 1 Schublade Höhe 100 mm.
- Zentralverriegelung mit vorderem Schloss.
- Versenkbare Seitengriffe zum bequemen Tragen.

📦 28 kg



h	max
50 mm	25 kg
70 mm	25 kg

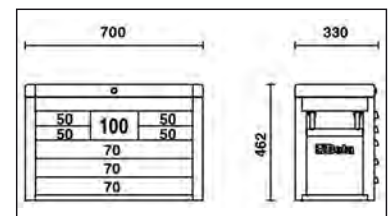
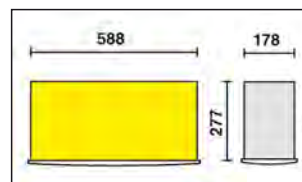

		€	📦	🚚
RSC23C-O	RAL 2011	790,00	1	023003011
RSC23C-R	RAL 3000	790,00	1	023003013
RSC23C-A	RAL 7016	790,00	1	023003017

RSC23T

Werkzeugkasten
mit 5 Schubladen

Hauptigenschaften:

- 5 Schubladen mit Teleskopführungen, kugelgelagert, 588x367 mm:
- 5 Schubladen Höhe 70 mm
- Zentralverriegelung mit vorderem Schloss.
- Möglichkeit zur Anbringung eines vierteiligen Radsatzes und eines Griffs (2300ST/KIT)

📦 36 kg



RSC23T-A



RSC23T-B



RSC23T-G



RSC23T-N



RSC23T-R



RSC23T-O



RSC23T-FO

 h	 max
70 mm	25 kg

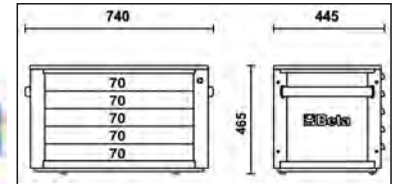
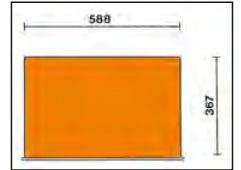

		€	📦	🖨️
RSC23T-FO	RAL 2011	882,00	1	023003020
RSC23T-O	RAL 2011	882,00	1	023003021
RSC23T-G	RAL 9006	882,00	1	023003022
RSC23T-R	RAL 3000	882,00	1	023003023
RSC23T-B	RAL 5015	882,00	1	023003026
RSC23T-A	RAL 7016	882,00	1	023003027
RSC23T-N	RAL 9005	882,00	1	023003029

2300ST/KIT

4-Rad-Satz und Griff für Art. C23ST

- Vier Räder Ø 125 mm:
- 2 starre und 2 lenkbare (davon 1 gebremst).
- Teleskopgriff

📦 6,5 kg

	€	📦	🖨️
2300ST/KIT	238,00	1	023000950



WERKZEUGWAGEN RSC24

Beta RSC24



NEUE ARBEITSPLATTE

**STABILER UND ROBUSTER
PRAKTISCHER
UND FUNKTIONELLER
MODERNER**



- Schubladen mit Teleskopführungen, kugelgelagert
- Schubladenböden mit Schaumgummibelag
- Jede Schublade kann bis zu 4 Schaumstoffeinsätze aus EVA oder feste Thermoformateinsätze aus ABS aufnehmen
- Neue ABS-verstärkte Arbeitsfläche, auf die der Werkzeugkasten RSC22, RSC23, RSC23C oder RSC23T aufgesetzt werden kann
- Multifunktionale Auflagefläche mit Seitenwänden zum Sturzschutz und acht Löchern zur Aufnahme der Schraubendreher
- Zentralverriegelung mit vorderem Sicherheitsschloss
- Vier Räder Ø 125 mm: 2 starre und 2 lenkbare (davon 1 gebremst)
- Statische Belastung: 800 kg

Verfügbare Modelle:

- RSC24/5 (5 Schubladen)
- RSC24/6 (6 Schubladen)
- RSC24/7 (7 Schubladen)
- RSC24/8 (8 Schubladen)

Verfügbare Farben:

RSC24-		
FO	RAL 2011	RAL 2011
O	RAL 7016	RAL 2011
G	RAL 7016	RAL 9006
R	RAL 7016	RAL 3000
B	RAL 7016	RAL 5015
A	RAL 7016	RAL 7016
N	RAL 9005	RAL 9005

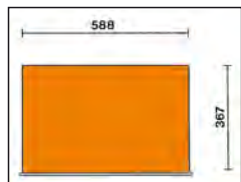
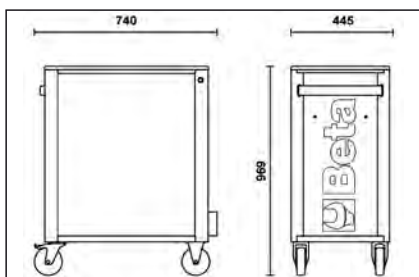

Verfügbares Zubehör:

2400 RSC24/PF

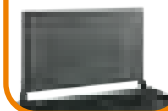

2400 RSC24/SPC



RSC24/7

Werkzeugwagen mit 7 Schubladen

Haupteigenschaften:

- 7 völlig herausnehmbare Schubladen mit Teleskopführungen, kugelgelagert, 588x367 mm:
- 5 Schubladen Höhe 70 mm
- 1 Schublade Höhe 140 mm
- 1 Schublade Höhe 210 mm

63 kg



RSC24/7-O

Beta RSC24



h			max
70 mm			25 kg
140 mm			30 kg
210 mm			30 kg

RSC24/7-	€	h		
RSC24/7-FO	1.230,00	1		024004070
RSC24/7-O	1.230,00	1		024004071
RSC24/7-G	1.230,00	1		024004072
RSC24/7-R	1.230,00	1		024004073
RSC24/7-B	1.230,00	1		024004076
RSC24/7-A	1.230,00	1		024004077
RSC24/7-N	1.230,00	1		024004079

RSC24/5

Werkzeugwagen mit 5 Schubladen

Haupteigenschaften:

- 5 völlig herausnehmbare Schubladen mit Teleskopführungen, kugelgelagert, 588x367 mm:
- 2 Schubladen Höhe 70 mm
- 2 Schubladen Höhe 140 mm
- 1 Schublade Höhe 280 mm

60 kg

	€	📦	🏠
RSC24/5-FO	1.062,00	1	024004050
RSC24/5-O	1.062,00	1	024004051
RSC24/5-G	1.062,00	1	024004052
RSC24/5-R	1.062,00	1	024004053
RSC24/5-B	1.062,00	1	024004056
RSC24/5-A	1.062,00	1	024004057
RSC24/5-N	1.062,00	1	024004059



RSC24/5-O

Beta RSC24



RSC24/5-FO



RSC24/5-A



RSC24/5-B



RSC24/5-G



RSC24/5-N



RSC24/5-R



h	max
70 mm	25 kg
140 mm	30 kg
280 mm	35 kg

RSC24/6

Werkzeugwagen mit 6 Schubladen

Haupteigenschaften:

- 6 völlig herausnehmbare Schubladen mit Teleskopführungen, kugelgelagert, 588x367 mm:
- 4 Schubladen Höhe 70 mm
- 1 Schublade Höhe 140 mm
- 1 Schublade Höhe 280 mm

62 kg

	€	📦	🏠
RSC24/6-FO	1.143,00	1	024004060
RSC24/6-O	1.143,00	1	024004061
RSC24/6-G	1.143,00	1	024004062
RSC24/6-R	1.143,00	1	024004063
RSC24/6-B	1.143,00	1	024004066
RSC24/6-A	1.143,00	1	024004067
RSC24/6-N	1.143,00	1	024004069



RSC24/6-O

Beta RSC24



RSC24/6-FO



RSC24/6-A



RSC24/6-B



RSC24/6-G



RSC24/6-N



RSC24/6-R



h	max
70 mm	25 kg
140 mm	30 kg
280 mm	35 kg

RSC24/8

Werkzeugwagen mit 8 Schubladen

Haupteigenschaften:

- 8 völlig herausnehmbare Schubladen mit Teleskopführungen, kugelgelagert, 588x367 mm:
- 6 Schubladen Höhe 70 mm
- 2 Schubladen Höhe 140 mm

66 kg

	€	📦	🏠
RSC24/8-FO	1.325,00	1	024004080
RSC24/8-O	1.325,00	1	024004081
RSC24/8-G	1.325,00	1	024004082
RSC24/8-R	1.325,00	1	024004083
RSC24/8-B	1.325,00	1	024004086
RSC24/8-A	1.325,00	1	024004087
RSC24/8-N	1.325,00	1	024004089



RSC24/8-O

Beta RSC24



RSC24/8-FO



RSC24/8-A



RSC24/8-B



RSC24/8-G



RSC24/8-N



RSC24/8-R



h	max
70 mm	25 kg
140 mm	30 kg

RSC24A/6

Werkzeugwagen mit 6 Schubladen und Anti-Kipp-System

Haupteigenschaften:

- 6 völlig herausnehmbare Schubladen mit Teleskopführungen, kugelgelagert, 588x367 mm:
- 4 Schubladen Höhe 70 mm
- 1 Schublade Höhe 140 mm
- 1 Schublade Höhe 280 mm

62 kg

	€	1	024004161
RSC24A/6-O	1.270,00	1	024004161
RSC24A/6-R	1.270,00	1	024004163
RSC24A/6-A	1.270,00	1	024004167



RSC24A/6-O

Beta RSC24



RSC24A/6-A



RSC24A/6-R



h	max
70 mm	25 kg
140 mm	30 kg
280 mm	35 kg



RSC24A/7

Werkzeugwagen mit 7 Schubladen und Anti-Kipp-System

Haupteigenschaften:

- 7 völlig herausnehmbare Schubladen mit Teleskopführungen, kugelgelagert, 588x367 mm:
- 5 Schubladen Höhe 70 mm
- 1 Schublade Höhe 140 mm
- 1 Schublade Höhe 210 mm

63 kg

	€	1	024004171
RSC24A/7-O	1.360,00	1	024004171
RSC24A/7-R	1.360,00	1	024004173
RSC24A/7-A	1.360,00	1	024004177



RSC24A/7-O

Beta RSC24



RSC24A/7-A



RSC24A/7-R



h	max
70 mm	25 kg
140 mm	30 kg
210 mm	30 kg



RSC24A/8

Werkzeugwagen mit 8 Schubladen und Anti-Kipp-System

Haupteigenschaften:

- 8 völlig herausnehmbare Schubladen mit Teleskopführungen, kugelgelagert, 588x367 mm:
- 6 Schubladen Höhe 70 mm
- 2 Schubladen Höhe 140 mm

66 kg

	€	1	024004181
RSC24A/8-O	1.470,00	1	024004181
RSC24A/8-R	1.470,00	1	024004183
RSC24A/8-A	1.470,00	1	024004187



RSC24A/8-O

Beta RSC24



RSC24A/8-A



RSC24A/8-R



h	max
70 mm	25 kg
140 mm	30 kg





LANGE AUSFÜHRUNG: kann bis zu 6 Schaumstoffeinsätze aus EVA oder feste Thermoformateinsätze aus ABS in jeder Schublade aufnehmen



**ANTI-KIPP-SYSTEM:
VERMEIDET DAS GLEICHZEITIGE
ÖFFNEN MEHRERER SCHUBLADEN**



- Schubladen mit Teleskopführungen, kugelgelagert
- ABS-verstärkte Arbeitsplatte mit Seitenwänden zum Sturzschutz, acht Löchern zur Aufnahme der Schraubendreher und 6 Aufnahmeschalen für Kleinteile.
- Frontblende aus hochbeständigem Nylon, mit integriertem Etikettenrahmen
- Vier Räder Ø 125 mm: 2 starre und 2 lenkbare (davon 1 gebremst)
- Statische Belastung: 1000 kg
- Schubladenböden mit Schaumgummibelag
- Integrierter seitlicher Flaschenhalter
- Zentralverriegelung mit vorderem Sicherheitschloss

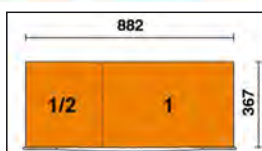
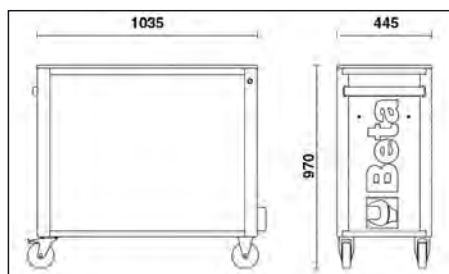

Verfügbare Farben:

Verfügbares Zubehör:

O	RAL 7016
R	RAL 7016
A	RAL 7016
	RAL 2011
	RAL 3000
	RAL 7016



2400 RSC24/PD-A



2400 RSC24/PL

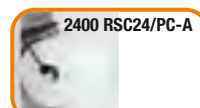

2400 RSC24/PC-A

RSC24AXL/7

Werkzeugwagen mit 7 Schubladen und Anti-Kipp-System, lange Ausführung

Haupteigenschaften:

- 7 völlig herausnehmbare Schubladen mit Teleskopführungen, kugelgelagert, 882x367 mm:
- 5 Schubladen Höhe 70 mm
- 1 Schublade Höhe 140 mm
- 1 Schublade Höhe 210 mm



Beta RSC24



RSC24AXL/7-A



RSC24AXL/7-R

		max
70 mm		30 kg
140 mm		35 kg
210 mm		35 kg



84 kg

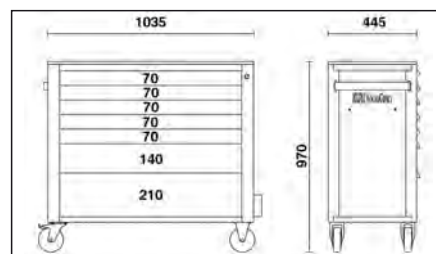
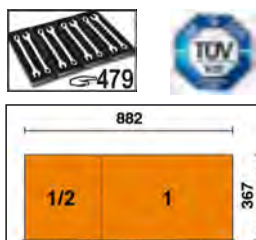

RSC24AXL/7-O	1.725,00 €	1	024004271
RSC24AXL/7-R	1.725,00 €	1	024004273
RSC24AXL/7-A	1.725,00 €	1	024004277

RSC24AXL/8

Werkzeugwagen mit 8 Schubladen und Anti-Kipp-System, lange Ausführung

Haupteigenschaften:

- 8 völlig herausnehmbare Schubladen mit Teleskopführungen, kugelgelagert, 882x367 mm:
- 6 Schubladen Höhe 70 mm
- 2 Schubladen Höhe 140 mm

88 kg

	€	1	024004281
RSC24AXL/8-O	1.850,00	1	024004281
RSC24AXL/8-R	1.850,00	1	024004283
RSC24AXL/8-A	1.850,00	1	024004287



h	max
70 mm	30 kg
140 mm	35 kg

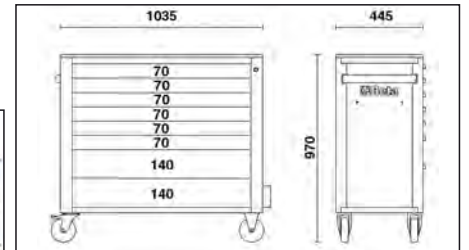
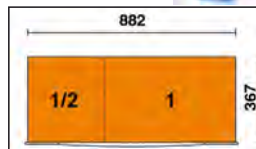

RSC24AXL/9

Werkzeugwagen mit 9 Schubladen und Anti-Kipp-System, lange Ausführung

Haupteigenschaften:

- 9 völlig herausnehmbare Schubladen mit Teleskopführungen, kugelgelagert, 882x367 mm:
- 8 Schubladen Höhe 70 mm
- 1 Schublade Höhe 140 mm

90 kg

	€	1	024004291
RSC24AXL/9-O	1.965,00	1	024004291
RSC24AXL/9-R	1.965,00	1	024004293
RSC24AXL/9-A	1.965,00	1	024004297



h	max
70 mm	30 kg
140 mm	35 kg

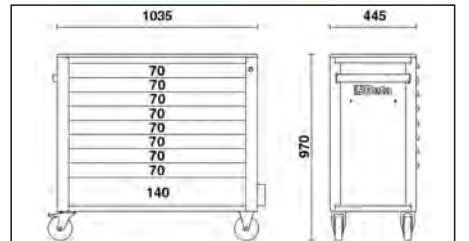

RSC24AXLP/7

Werkzeugwagen mit 7 Schubladen, Arbeitsplatte aus Holz und Anti-Kipp-System, lange Ausführung

Hauptmerkmale:

- 7 völlig herausnehmbare Schubladen mit Teleskopführungen, kugelgelagert, 882x367:

- 5 Schubladen Höhe 70 mm

- 1 Schublade Höhe 140 mm

- 1 Schublade Höhe 210 mm

- Multiplex-Arbeitsplatte mit Löchern zur Aufnahme eines Schraubstocks Art. 1599F/100 oder Art. 1599GI/100 (separat zu bestellen)
- Frontblende aus hochbeständigem Nylon, mit integriertem Etikettenrahmen
- Schubladenböden mit Schaumgummibelag
- Vier Räder Ø 125 mm: 2 fest und 2 drehbar (davon 1 gebremst)
- Zentralverriegelung mit Sicherheitsschloss
- Statische Belastung: 1.100 kg
- Integrierter seitlicher Flaschenhalter (beidseitig montierbar) • Integrierter Papierrollenhalter
- Jede Schublade kann bis zu 6 Schaumstoffeinsätze aus EVA oder feste Thermoformateinsätze aus ABS aufnehmen

1105 kg



h	max
70 mm	30 kg
140 mm	35 kg
210 mm	35 kg

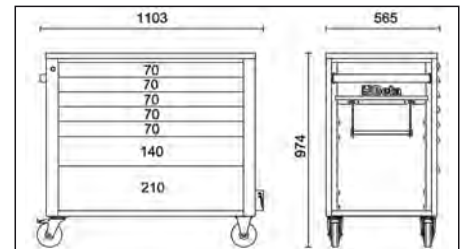
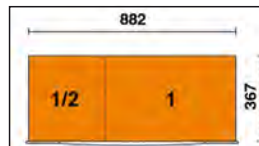

	€	1	024004571
RSC24AXLP/7-O	1.985,00	1	024004571
RSC24AXLP/7-R	1.985,00	1	024004573
RSC24AXLP/7-A	1.985,00	1	024004577

2400 RSC24AXLP/CPR

Abfallbehälter für Werkzeugwagen Art. RSC24AXLP/7

5 kg



	€	1	024004993
2400 RSC24AXLP/CPR	76,50	1	024004993

2400 RSC24AXLP/PF

Werkzeuglochtafel mit Halterungen für Werkzeugwagen Art. RSC24AXLP/7

4,5 kg



	€	1	024004992
2400 RSC24AXLP/PF	140,00	1	024004992

2400 RSC24AXLP/VL

Seitliche Werkzeugwanne für Werkzeugwagen Art. RSC24AXLP/7

4 kg

2400 RSC24AXLP/VL

€ 58,50 1 024004995



2400 RSC24/PC

Papierrollenhalter für vorgestanzte Rollen, für Werkzeugwagen RSC24, RSC24A, RSC24AXL, RSC51

0,3 kg

2400 RSC24/PC-A
2400 RSC24/PC-N

€ 29,00 1 024004903
€ 29,00 1 024004904



RAL7016 2400 RSC24/PC-A
RAL9005 2400 RSC24/PC-N



2400 RSC24/PD

Dokumentenhalter für Werkzeugwagen RSC24, RSC24A, RSC24AXL

1,2 kg

2400 RSC24/PD-A
2400 RSC24/PD-N

€ 50,50 1 024004907
€ 50,50 1 024004908

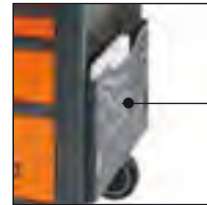
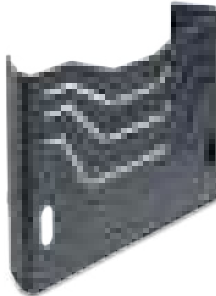

RAL7016 2400 RSC24/PD-A
RAL9005 2400 RSC24/PD-N



2400 RSC24/PF

Werkzeuglochtafel mit Halterungen für Werkzeugwagen Art. RSC24, RSC24A, RSC51

2,3 kg

2400 RSC24/PF

€ 91,50 1 024004902

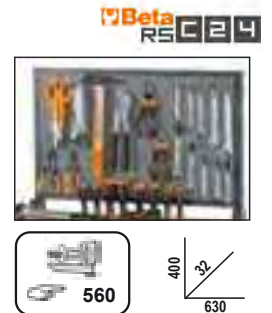

2400 RSC24/PF-

Flaschenhalter für Werkzeugwagen Art. RSC24, RSC24A

0,5 kg

2400 RSC24/PF-A
2400 RSC24/PF-N

€ 30,50 1 024004905
€ 30,50 1 024004906



RAL7016 2400S RSC24/PF-A
RAL9005 2400S RSC24/PF-N



2400 RSC24/PL

Arbeitsfläche aus Holz für Werkzeugwagen Art. RSC24, RSC24A, RSC24AXL, RSC51

4,3 kg

2400 RSC24/PL

€ 114,50 1 024004901



2400 RSC24/SPC

Computerhalter für Werkzeugwagen Art. RSC24, RSC24A, RSC24AXLP/7, RSC51

- Mit herausnehmbarer Schublade
- Nicht kombinierbar mit Art. RSC24AXL

3,1 kg

2400 RSC24/SPC € 166,00 1 024004909



2400 RSC24/MP

Klappbares Regal für Art. RSC24, RSC24A, RSC24AXLP/7, RSC51

- Verwendbar als zusätzliche Arbeitsablage
- Arbeitsfläche, 390x440 mm, geschützt mit öl- und benzinfestem Gummibelag
- Tragfähigkeit: 20 kg

3,4 kg

2400 RSC24/MP € 87,50 1 024004900

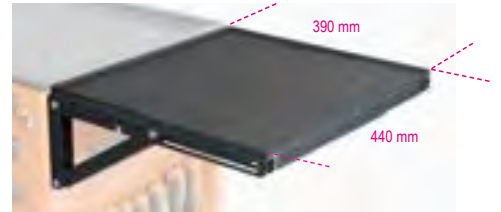

2499PF

Fläschchenhalter

- Als Ergänzung für Werkzeugwagen C38, C38A

2,5 kg

2499PF-O € 85,00 1 024990210
2499PF-G € 85,00 1 024990219
2499PF-R € 85,00 1 024990230

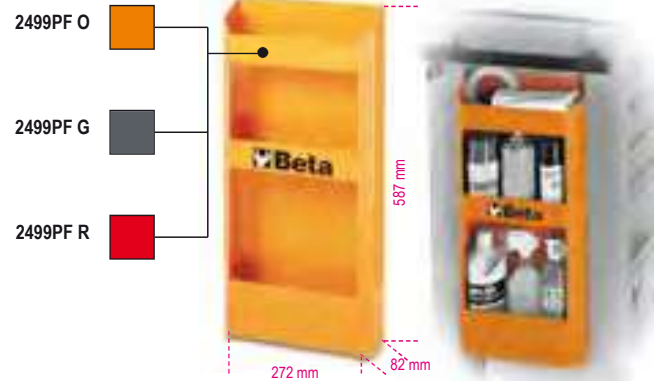

2499PF/M

Universeller Magnet-Fläschchenhalter

2,2 kg

2499PF/M € 77,00 1 024990050



2499PC

Papierrollenhalter für vorgestanzte Rollen

- Als Ergänzung für Werkzeugwagen Tank C25 und C38.

2,2 kg

2499PC € 90,50 1 024990090



RSC24L/7

Werkzeugwagen
mit 7 Schubladen
und Seitenablagen

Haupteigenschaften:

- 7 Schubladen mit Teleskopführungen, kugelgelagert, 588x367 mm:
- 5 Schubladen Höhe 70 mm
- 1 Schublade Höhe 140 mm
- 1 Schublade Höhe 210 mm.
- Schubladenböden mit Schaumgummibelag.
- Vier Räder Ø 125 mm:
- 2 fest und 2 drehbar (gebremst).
- Zentralverriegelung mit vorderem Schloss.
- Statische Belastung: 1.100 kg.
- Multiplex-Arbeitsplatte mit Bohrungen zum Einbringen eines Schraubstocks (1599F/100 - 1599GI/100 , separat zu bestellen).
- Seitenfach mit höhenverstellbarem Einlegeboden.
- Integrierter Papierrollenhalter.
- Zwei Flaschenhalter (hinten).
- Integrierter seitlicher Flaschenhalter

80 kg

		€		
RSC24L/7-O	RAL 2011	1.865,00	1	024004371
RSC24L/7-R	RAL 3000	1.865,00	1	024004373
RSC24L/7-A	RAL 7016	1.865,00	1	024004377

Beta RS C24

1100 kg



h	max
70 mm	25 kg
140 mm	30 kg
210 mm	30 kg

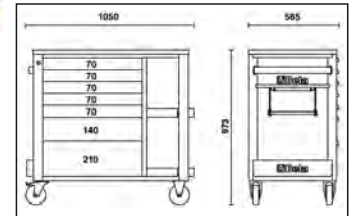
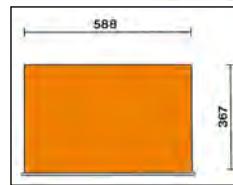

RSC24L-CAB

Werkzeugwagen
mit sieben Schubladen
und Ablageschrank

Haupteigenschaften:

- 7 Schubladen mit Teleskopführungen, kugelgelagert, 588x367 mm:
- 5 Schubladen Höhe 70 mm
- 1 Schublade Höhe 140 mm
- 1 Schublade Höhe 210 mm.
- Schubladenböden mit Schaumgummibelag.
- Vier Räder Ø 125 mm:
- 2 fest und 2 drehbar (gebremst).
- Zentralverriegelung mit vorderem Schloss.
- Seitlicher Ablageschrank mit verschließbarem Schrankflügel und höhenverstellbarem interner Ablage.
- Statische Belastung: 1.100 kg.
- Multiplex-Arbeitsplatte mit Bohrungen zum Einbringen eines Schraubstocks (1599F/100, separat zu bestellen).
- Integrierter Papierrollenhalter.
- Zwei Flaschenhalter (hinten).
- Integrierter seitlicher Flaschenhalter

82 kg

		€		
RSC24L-CAB/O	RAL 2011	1.925,00	1	024004471
RSC24L-CAB/R	RAL 3000	1.925,00	1	024004473
RSC24L-CAB/A	RAL 7016	1.925,00	1	024004477

Beta RS C24

1100 kg

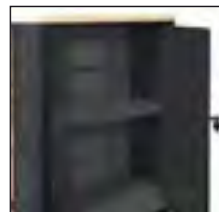

h	max
70 mm	25 kg
140 mm	30 kg
210 mm	30 kg

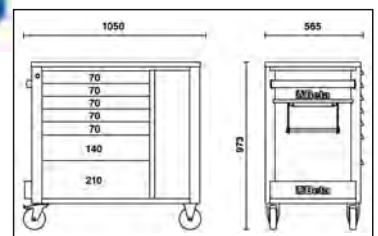
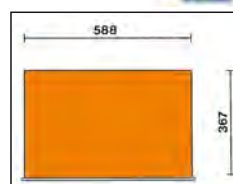

C04TSS-7

Werkzeugwagen mit sieben Schubladen,
komplett aus Edelstahl, **Abriebfeste Räder**

Haupteigenschaften:

- Sieben Schubladen mit Teleskopführungen, kugelgelagert, 570 x 410 mm:
- 6 Schubladen Höhe 83 mm;
- 1 Schublade Höhe 170 mm;
- 4 Räder Ø 125 mm
- 2 starre und 2 lenkbare (davon 2 gebremst);
- Zentralverriegelung mit vorderem Schloss;
- Struktur vollständig aus Edelstahl;
- Räder, Halterungen, Kugeln, Schubladen innen und Führungen aus Edelstahl;
- Schubladengriff aus Aluminium.



63 kg

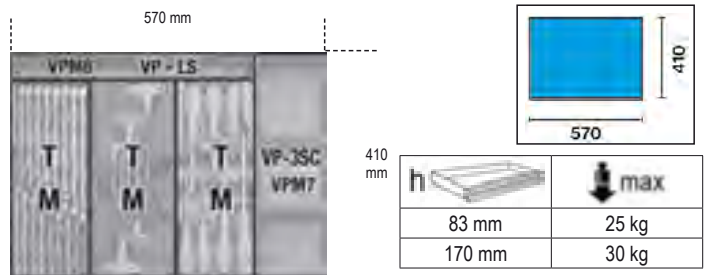

C04TSS/7

€ 3.100,00

1

024003077

303

C25

Werkzeugwagen Tank mit Bord

Haupteigenschaften:

- Klappdeckel.
- 1 Schublade.
- Werkzeugablage mit Schaumgummibelag.
- Öl- und benzinfeste Gummibeläge.
- 4 Räder ø 100 mm:
- 2 starre und 2 lenkbare Räder (eins mit Bremse).
- Sicherheitsschloss.
- Thermoformateinsatz für Steckschlüssel und Zubehör 1/2" leer.(024990104).
- Montage des Papierrollenhalters 2499PC möglich.



31,5 kg

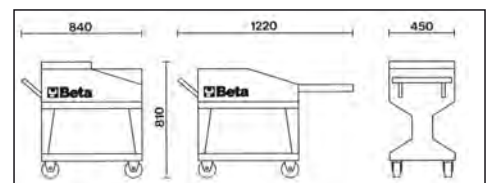

C25

€ 800,00

1

025000001

C27S

Werkzeugwagen zusammenklappbar für externe Eingriffe

Verschließbarer Wagen mit zusammenklappbaren Säulen für einen mühelosen Transport.

2 Schubladen 588x277 mm, mit Teleskopführungen, sodass sie jeweils in 2 Richtungen geöffnet werden können.

Großes unteres Werkzeugfach 588x277x220 mm.

Struktur aus Blech.

2 starre Räder Ø 160 mm und 2 lenkbare Räder Ø 100 mm mit Bremse.

Thermoplastische Arbeitsplatte mit 6 integrierten Schalen für Kleinteile.

Zentralverriegelung.

Ausgelegt zum Einfügen von Trennwänden für die Schublade und MC Thermoformateinsätzen zur Aufnahme von Werkzeug.

20 kg



C27S-O



C27S-G



C27S-R



h	max
70 mm	20 kg

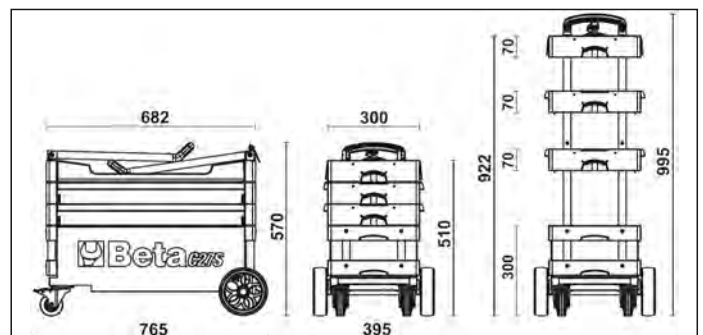
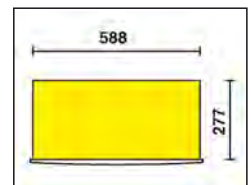

		€	↓	↑
C27S-O	RAL 2011	897,00	1	027000201
C27S-G	RAL 7016	897,00	1	027000202
C27S-R	RAL 3000	897,00	1	027000203

RSC28

Werkzeugwagen SuperTank mit Arbeitsplatte aus Holz und 10 Schubladen

Haupteigenschaften:

- 10 Schubladen mit Teleskopführungen, kugelgelagert, 588x367 mm.
- System zur schnellen und sicheren Öffnung und Schließung der Schubladen mit Frontblende aus Nylon und Glasfaser.
- Fünf seitliche Schubladen:
- 4 Schubladen Höhe 70 mm
- 1 Schublade Höhe 210 mm.
- Fünf vordere Schubladen:
- 4 Schubladen Höhe 70 mm
- 1 Schublade Höhe 210 mm.
- Schubladenböden mit Schaumgummibelag.
- Vier Räder mit hoher Tragkraft Ø 150 mm:
- 2 fest und 2 drehbar (gebremst).
- Doppelte Zentralverriegelung mit Sicherheitsschloss.
- 3 frontale Schubladen zur Ablage.
- Multiplex-Arbeitsplatte mit Bohrungen zum Einbringen eines Schraubstocks (1599F/150 - 1599GI/150, separat zu bestellen).
- Integriertes Kleinteilefach.
- Seitliches Fach mit versenkbarer Tür und Schloss.
- Integrierte Flaschenhalter.
- Durchgehendes 135 mm hohes Fach mit Kunststoffabdeckung.
- Statische Belastung: 1.200 kg.

1200
kg



RSC28-O

130 kg



RSC28-A



RSC28-R



h	max
70 mm	25 kg
210 mm	30 kg

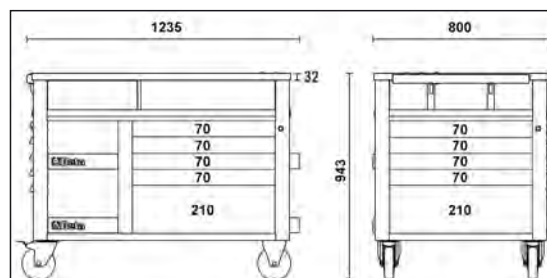
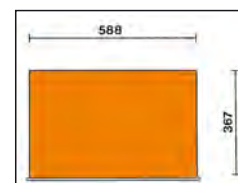

	€	📦	🏠
RSC28-O	3.390,00	1	028003001
RSC28-R	3.390,00	1	028003003
RSC28-A	3.390,00	1	028003007

C30M

Mobiler Arbeitsplatz MaxiTank

Haupteigenschaften:

- 5 Frontschubladen mit Teleskopführungen, kugelgelagert:
- 3 Schubladen 367x610 mm, Höhe 90 mm
- 1 Schublade 588x610 mm, Höhe 90 mm
- 1 Schublade 588x610 mm, Höhe 180 mm
- Schnellöffnungssystem mit Frontblende aus Aluminium.
- Schubladenböden mit Schaumgummibelag.
- Ausgelegt zum Einfügen von Thermoformateinsätzen.
- Ein Hydraulikheber ermöglicht das mühelose Anheben des Frontteils und somit einen praktischen Transport.
- Vier Räder mit hoher Tragkraft:
- 2 drehbar, vorne, Ø 150 mm
- 2 fest, hinten, Ø 170 mm.
- Arbeitsplatte mit ölfestem Gummibelag, 1300x800 mm, mit Ablaufloch, zum Auffangen von Flüssigkeiten.
- Durchgehendes Fach, 720x250x1300 mm, mit PVC-Überzug, frontal mit versenkbaren Türen zu verschließen.
- Zentralverriegelung für Schubladen und Türen.
- 3 integrierte seitliche Flaschenhalter.
- Integrierter Papierrollenhalter
- Statische Belastung: 1.800 kg.
- Ausgelegt für das Anbringen einer Multiplex-Arbeitsplatte (3000M/PLM), die separat zu bestellen ist
- Bohrungen zum Einbringen eines Schraubstocks (1599F/150, separat zu bestellen)

1800
kg



200 kg

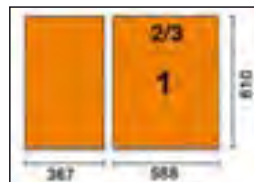

h	max
90 mm	30 kg
180 mm	35 kg

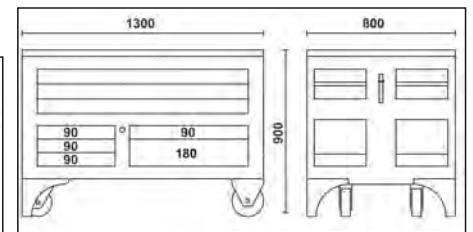

C30M

€ 5.410,00 1 030000300

3000M/PLM

Arbeitsplatte aus Holz für Art. C30M,
mit Bohrungen zum Einbringen eines Schraubstocks (1599F/150)

10 kg



1240x740x26 mm

3000M/PLM

€ 525,00 1 030000350

PRAKTISCH UND ROBUST



- Herausnehmbare Schubladen
- Zentralverriegelung mit vorderem Sicherheitsschloss
- Ausgelegt für Montage von Arbeitsfläche und Schubladentrennwänden, separat zu bestellen
- Statische Belastung: 1200 kg

Verfügbare Modelle:

- **C35/6GM** (6 Schubladen)
- **C35/7GM** (7 Schubladen)
- **C35/8GM** (8 Schubladen)
- **C35/9GM** (9 Schubladen)

Verfügbares Zubehör:

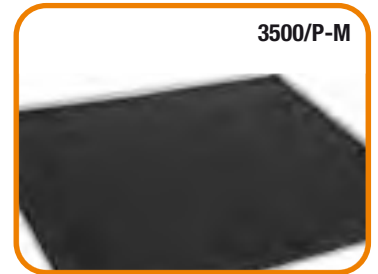

C35/6GM

Industrieller fester Werkzeugkasten mit 6 Schubladen

Hauptmerkmale:

- 6 Schubladen, 600x447 mm, ganz herausziehbar.
- 2 Schubladen Höhe 75 mm
- 1 Schublade Höhe 100 mm
- 1 Schublade Höhe 150 mm
- 1 Schublade Höhe 200 mm
- 1 Schublade Höhe 300 mm
- Zentralverriegelung mit vorderem Sicherheitsschloss.
- Ausgelegt für Montage von Arbeitsfläche und Schubladentrennwänden, separat zu bestellen

75 kg



Höhe	max. Gewicht
75 mm	70 kg
100 mm	70 kg
150 mm	70 kg
200 mm	70 kg
300 mm	70 kg

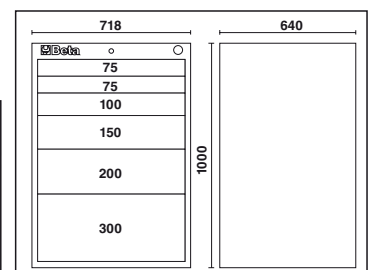

C35/6GM € 2.175,00 1 035000162

C35/7GM

Industrieller fester Werkzeugkasten mit 7 Schubladen

Hauptmerkmale:

- 7 Schubladen, 600x447 mm, ganz herausziehbar:
- 2 Schubladen Höhe 75 mm
- 1 Schublade Höhe 100 mm
- 3 Schubladen Höhe 150 mm
- 1 Schublade Höhe 200 mm
- Zentralverriegelung mit vorderem Sicherheitsschloss.
- Ausgelegt für Montage von Arbeitsfläche und Schubladentrennwänden, separat zu bestellen

82 kg

C35/7GM € 2.270,00 1 035000172

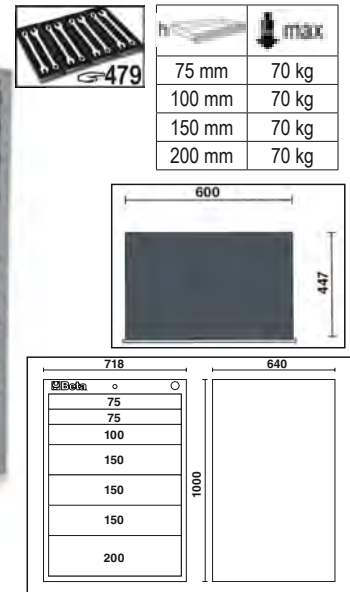

C35/8GM

Industrieller fester Werkzeugkasten mit 8 Schubladen

Hauptmerkmale:

- 8 Schubladen, 600x447 mm, ganz herausziehbar:
- 4 Schubladen Höhe 75 mm
- 1 Schublade Höhe 100 mm
- 2 Schubladen Höhe 150 mm
- 1 Schublade Höhe 200 mm
- Zentralverriegelung mit vorderem Sicherheitsschloss.
- Ausgelegt für Montage von Arbeitsfläche und Schubladentrennwänden, separat zu bestellen

86 kg

C35/8GM € 2.425,00 1 035000182

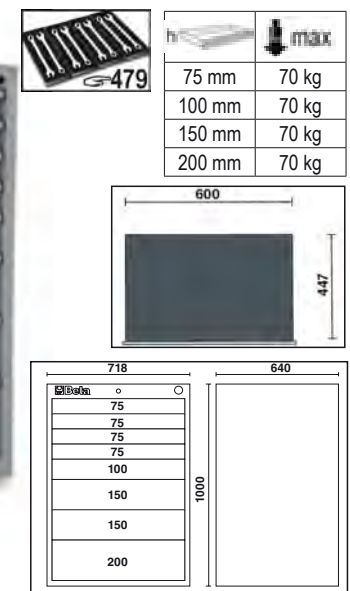

C35/9GM

Industrieller fester Werkzeugkasten mit 9 Schubladen

Hauptmerkmale:

- 9 Schubladen, 600x447 mm, ganz herausziehbar:
- 6 Schubladen Höhe 75 mm
- 3 Schubladen Höhe 150 mm
- Zentralverriegelung mit vorderem Sicherheitsschloss.
- Ausgelegt für Montage von Arbeitsfläche und Schubladentrennwänden, separat zu bestellen

91 kg

C35/9GM € 2.540,00 1 035000192

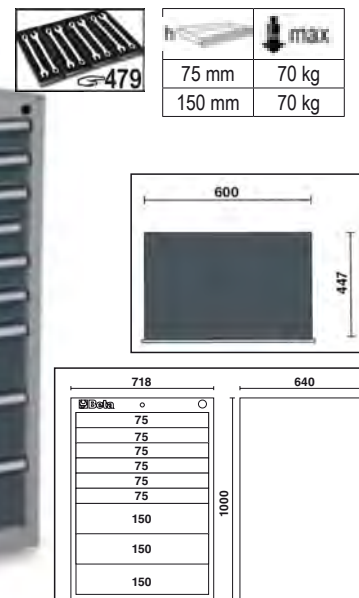

3500/P-M

Arbeitsplatte mit Außenkante für Werkzeugkasten Art. C35

3500/P-M 700x600 mm € 424,00 1 035000505



ECKKANTENSCHUTZ

- Schubladen mit Teleskopführungen, kugelgelagert
- Hoch widerstandsfähige Multifunktions-Arbeitsplatte
- Schnellriegelungssystem aus Aluminium mit der Möglichkeit zur Öffnung auf der ganzen Schubladenlänge
- Kleinteile-Ablageschalen und Löcher zur Aufnahme der Schraubendreher
- Vier Räder Ø 125 mm: 2 starre und 2 lenkbare (davon 1 gebremst)
- Statische Belastung: 1000 kg
- Eckkantenschutz auf der ganzen Höhe des Werkzeugwagens, um bei Anstoßen die Beschädigung der Fahrzeuge in der Werkstatt zu vermeiden
- Schubladenböden mit Schaumgummibelag
- Zentralverriegelung mit vorderem Sicherheitsschloss
- Integrierte seitliche Flaschenhalter und Papierrollenhalter, verstellbar auf mehrere Positionen

Verfügbare Modelle:

- C37/6 (6 Schubladen)
- C37/7 (7 Schubladen)
- C37/8 (8 Schubladen)
- C37A/7 (7 Schubladen mit Anti-Kipp-System)



Verfügbare Farben:

O	RAL 2011
G	RAL 7016
R	RAL 3000

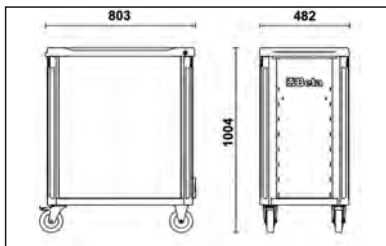

Verfügbares Zubehör:



3700/PLA



3700/PLL



3700/PF



3700/PFL



3700/PC



C37/7

Werkzeugwagen mit 7 Schubladen

Haupteigenschaften:

- 7 Schubladen, 588x367 mm, mit Teleskopführungen, kugelgelagert:
- 5 Schubladen Höhe 75 mm
- 1 Schublade Höhe 150 mm
- 1 Schublade Höhe 225 mm

71 kg

1000 kg



C37/7-O



C37/7-G



C37/7-R



	€	📦	🚚
C37/7-O	1.480,00	1	037000071
C37/7-G	1.480,00	1	037000072
C37/7-R	1.480,00	1	037000073

h	max
75 mm	30 kg
150 mm	35 kg
225 mm	35 kg

C37/6

Werkzeugwagen
mit 6 Schubladen

Haupteigenschaften:

- 6 Schubladen, 588x367 mm, mit Teleskopführungen, kugelgelagert:
- 4 Schubladen Höhe 75 mm
- 1 Schublade Höhe 150 mm
- 1 Schublade Höhe 305 mm

1000
kg



C37/6-O

69 kg

	€	📦	🖨️
C37/6-O	1.430,00	1	037000061
C37/6-G	1.430,00	1	037000062
C37/6-R	1.430,00	1	037000063



C37/6-G



C37/6-R



h	max
75 mm	30 kg
150 mm	35 kg
305 mm	40 kg



C37/8

Werkzeugwagen
mit 8 Schubladen

Haupteigenschaften:

- 8 Schubladen, 588x367 mm, mit Teleskopführungen, kugelgelagert:
- 6 Schubladen Höhe 75 mm
- 2 Schubladen Höhe 150 mm

1000
kg



C37/8-O

73 kg

	€	📦	🖨️
C37/8-O	1.535,00	1	037000081
C37/8-G	1.535,00	1	037000082
C37/8-R	1.535,00	1	037000083



C37/8-G



C37/8-R



h	max
75 mm	30 kg
150 mm	35 kg



C37A/7

Werkzeugwagen
mit 7 Schubladen und Anti-Kipp-System

Haupteigenschaften:

- 7 Schubladen mit Teleskopführungen, kugelgelagert, 588x367 mm:
- 5 Schubladen Höhe 75 mm
- 1 Schublade Höhe 150 mm
- 1 Schublade Höhe 225 mm

1000
kg



C37A/7-O

71 kg

	€	📦	🖨️
C37A/7-O	1.520,00	1	037000271
C37A/7-G	1.520,00	1	037000272
C37A/7-R	1.520,00	1	037000273



C37A/7-G



C37A/7-R



h	max
75 mm	30 kg
150 mm	35 kg
225 mm	35 kg



3700/PLA

Arbeitsplatte aus rostfreiem Stahl für Werkzeugwagen C37

2,8 kg

3700/PLA € 86,00 1 037000100



3700/PLL

Arbeitsplatte aus Holz für Werkzeugwagen Art. C27

Ausgelegt zur Aufnahme eines Schraubstocks Art. 1599P/100 (separat zu bestellen)

3,9 kg

3700/PLL € 108,00 1 037000101



672x396x28 mm

3700/PF

Lochplatte mit Halterungen für Werkzeugwagen Art. C37

3,2 kg

3700/PF € 85,50 1 037000102



3700/PFL

Seitliche Lochplatte für Werkzeugwagen Art. C37

1,9 kg

3700/PFL € 45,50 1 037000104



3700/PC

Computerhalter für Werkzeugwagen Art. C37

3,1 kg

3700/PC € 117,00 1 037000103



C38

Werkzeugwagen mit elf Schubladen

Haupteigenschaften:

- 11 Schubladen mit Teleskopführungen, kugelgelagert:
- 1 Schublade 937x410x122 mm
- 3 Schubladen 570x410x74 mm
- 2 Schubladen 570x410x153 mm
- 3 Schubladen 313x410x74 mm
- 2 Schubladen 313x410x153 mm.
- Schubladenböden mit Schaumgummibelag.
- Statische Belastung: 1200 kg.
- 4 Räder mit hoher Tragkraft: Ø 125 mm,
- 2 starre und 2 lenkbare Räder (beide mit Hebelbremse).
- Vorderes Schloss mit Zentralverriegelung.
- Arbeitsplatte aus Blech mit Gummibelag.
- Montage des Papierrollenhalters Art. 2499PC und des Fläschchenhalters Art. 2499PF möglich.

114 kg



h	max
74 mm	25 kg
153 mm	30 kg

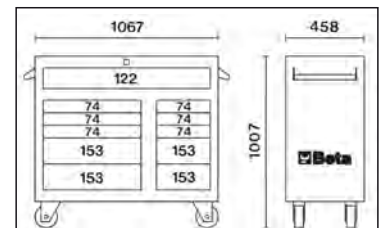
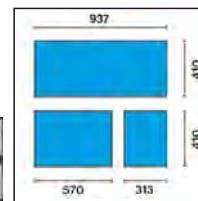

	€		
C38-O	2.335,00	1	038000001
C38-G	2.335,00	1	038000003
C38-R	2.335,00	1	038000002

C38L

Seitlicher Werkzeugkasten mit 7 Schubladen

Haupteigenschaften:

- 7 Schubladen mit Teleskopführungen, kugelgelagert, 410x313 mm:
- 5 Schubladen Höhe 74 mm 2 Schubladen Höhe 153 mm.
- Schubladenböden mit Schaumgummibelag.
- Zentralverriegelung mit vorderem Sicherheitsschloss.
- Arbeitsplatte aus rutschfestem Aluminium.
- An beiden Seiten vom Werkzeugwagen Art. C38 einsetzbar.

45 kg



h	max
74 mm	25 kg
153 mm	30 kg

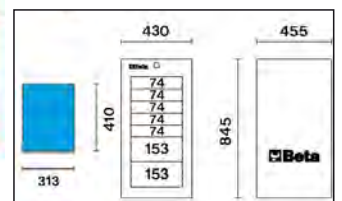

	€		
C38L-O	1.134,00	1	038000081
C38L-G	1.134,00	1	038000083
C38L-R	1.134,00	1	038000082

C38LA

Seitenmodul mit Tür und Innenregal

Haupteigenschaften:

- Zentralverriegelung mit vorderem Schloss.
- Höhenverstellbares Innenregal.
- Im Türflügel positionierte Dokumentenaufbewahrungstasche.
- Arbeitsplatte aus rutschfestem Aluminium.
- An beiden Seiten vom Werkzeugwagen C38 einsetzbar.

18 kg

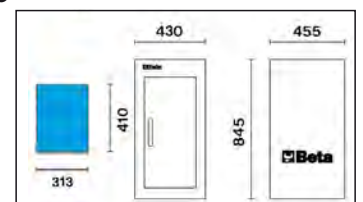

	€		
C38LA O	433,00	1	038000071
C38LA G	433,00	1	038000073
C38LA R	433,00	1	038000072

C38C

Werkzeugwagen mit 25 Schubladen, mit:

- 1 Werkzeugwagen C38
- 2 seitlichen Werkzeugkästen C38L
- 1 Werkzeugkasten Top C38T.

268 kg



C38C-O



C38C-G



C38C-R



h	max
74 mm	25 kg
153 mm	30 kg

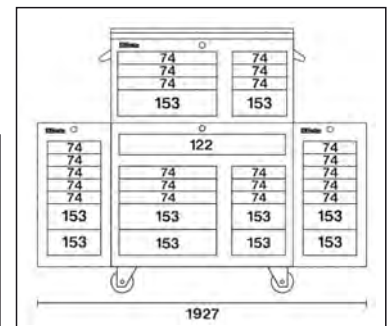
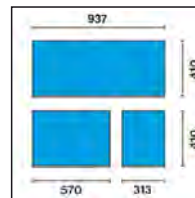

C38C-O	€ 6.080,00	1	038000201
C38C-G	€ 6.080,00	1	038000203
C38C-R	€ 6.080,00	1	038000202

C38T

Werkzeugkasten Top mit 8 Schubladen und Werkzeugfach

Haupteigenschaften:

- 8 Schubladen mit Teleskopführungen, kugelgelagert:
- 3 Schubladen 570x410x74 mm
- 1 Schublade 570x410x153 mm
- 3 Schubladen 313x410x74 mm
- 1 Schublade 313x410x153 mm.
- Werkzeugfach.
- Schubladenböden mit Schaumgummibelag.
- Zentralverriegelung mit vorderem Sicherheitsschloss.
- Auf Werkzeugwagen C38 positionierbar.

64 kg



C38T-O



C38T-G



C38T-R

h	max
74 mm	25 kg
153 mm	30 kg

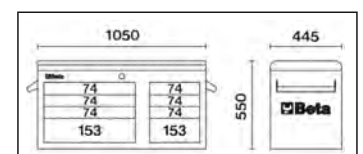
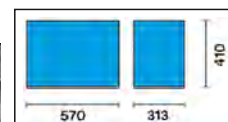

C38T-O	€ 1.475,00	1	038000091
C38T-G	€ 1.475,00	1	038000093
C38T-R	€ 1.475,00	1	038000092

WERKZEUGWAGEN C39

STRUKTUR UND SCHUBLADENFRONT IN ALUMINIUM-LEGIERUNG RESISTENTER UND LEICHTER

- Schubladen mit Teleskopführungen, kugelgelagert
- Thermoplastische Arbeitsplatte, auf die der Werkzeugkasten C39T aufgesetzt werden kann
- Schnellentriegelungssystem aus Aluminium mit der Möglichkeit zur Öffnung auf der ganzen Schubladenlänge
- Vier Räder Ø 125 mm: 2 starre und 2 lenkbare (davon 1 gebremst)
- Statische Belastung: 1200 kg
- Schubladenböden mit Schaumgummibelag
- Zentralverriegelung mit vorderem Sicherheitsschloss
- Kleinteile-Ablageschalen und Löcher zur Aufnahme der Schraubendreher
- Integrierte Flaschenhalter, seitlich und rückseitig
- Integrierter Papierrollenhalter

Verfügbare Modelle:

- C39/6 (6 Schubladen)
- C39/7 (7 Schubladen)
- C39/8 (8 Schubladen)

Verfügbare Farben:

	
O	RAL 2011
G	RAL 7016
R	RAL 3000

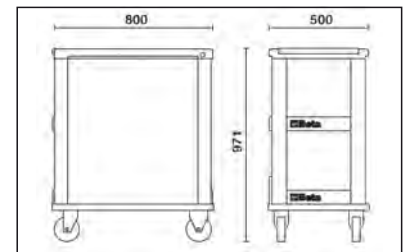

C39/7

Werkzeugwagen mit sieben Schubladen

Haupteigenschaften:

- Sieben Schubladen mit Teleskopführungen, kugelgelagert, 588x367 mm:
 - 5 Schubladen Höhe 70 mm
 - 1 Schublade Höhe 140 mm.
 - 1 Schublade Höhe 210 mm

61 kg

1200 kg



C39-7/G



C39-7/R

C39-7/O

h	max
70 mm	30 kg
140 mm	35 kg
210 mm	35 kg



G479

	€	📦	🚚
C39-7/O	2.225,00	1	039000001
C39-7/G	2.225,00	1	039000002
C39-7/R	2.225,00	1	039000003

C39/6

Werkzeugwagen mit sechs Schubladen

Haupteigenschaften:

- Sechs Schubladen mit Teleskopführungen, kugelgelagert, 588x367 mm:
- 4 Schubladen Höhe 70 mm
- 1 Schublade Höhe 140 mm
- 1 Schublade Höhe 280 mm

1200 kg

59 kg

	€	📦	📄
C39-6/O	2.110,00	1	039000031
C39-6/G	2.110,00	1	039000032
C39-6/R	2.110,00	1	039000033



C39-6/O



C39-6/G



C39-6/R



h	max
70 mm	30 kg
140 mm	35 kg
280 mm	40 kg



C39/8

Werkzeugwagen mit acht Schubladen

Haupteigenschaften:

- Acht Schubladen mit Teleskopführungen, kugelgelagert, 588x367 mm:
- 6 Schubladen Höhe 70 mm
- 2 Schubladen Höhe 140 mm

1200 kg

64 kg

	€	📦	📄
C39-8/O	2.380,00	1	039000041
C39-8/G	2.380,00	1	039000042
C39-8/R	2.380,00	1	039000043



C39-8/O



C39-8/G



C39-8/R



h	max
70 mm	30 kg
140 mm	35 kg



C39T

Werkzeugkasten mit vier Schubladen

Haupteigenschaften:

- Vier Schubladen mit Teleskopführungen, kugelgelagert, 588x367 mm:
- 4 Schubladen Höhe 70 mm
- Zentralverriegelung mit vorderem Sicherheitsschloss.
- Streben und Schubladenfront aus Aluminium.

29 kg

	€	📦	📄
C39T-O	1.430,00	1	039000101
C39T-G	1.430,00	1	039000102
C39T-R	1.430,00	1	039000103



C39T-O



C39T-G

C39T-R



29 kg

h	max
70 mm	30 kg

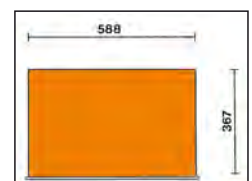
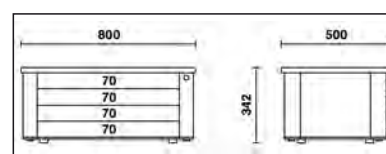

2400-COVER RSC24

Nylonschutzabdeckung für Werkzeugwagen RSC24/SA - C39

2400-COVER RSC24 € 29,00 1 024000910



2400-COVER RSC24AXL

Nylonschutzabdeckung für Werkzeugwagen RSC24A-XL, RSC24L, RSC24L-CAB

2400-COVER RSC24AXL € 39,50 1 024000930



3700-COVER C37

Nylonschutzabdeckung für Werkzeugwagen Art. C37

3700-COVER C37 € 38,00 1 037000930



The Beta logo is prominently displayed in the center, with a background image of various tools including wrenches, sockets, and a screwdriver.

C39SM

Spezieller Werkzeugwagen vom Typ Racing SM

Technische Merkmale

- Arbeitsfläche aus Multiplexplatte
- 4 Räder Ø 125 mm
- 2 starre und 2 lenkbare (eins mit Bremse) mit Schutzabdeckung
- Statische Belastung: 1200 kg

Modul mit 7 Schubladen

mit Teleskopführungen, kugelgelagert, 588x367 mm:

- 6 Schubladen Höhe 70 mm
- 1 Schublade Höhe 240 mm
- Schubladenböden mit Schaumgummibelag
- Zentralverriegelung mit vorderem Sicherheitsschloss
- Über die gesamte Schubladenlänge positioniertes Öffnungssystem
- Schubladenfront aus Aluminium

Servicemodul

- Eingebauter Mülleimer
- Papierrollenfach
- 1 großes Ablagefach 420x305x270 mm

125 kg

		€	1	
C39SM-O	RAL 2011	3.620,00	1	039390001
C39SM-G	RAL 7016	3.620,00	1	039390002
C39SM-R	RAL 3000	3.620,00	1	039390003

1200 kg



C39SM-G

C39SM-R

C39SM-O

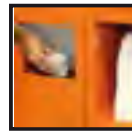

h	max
70 mm	30 kg
240 mm	40 kg

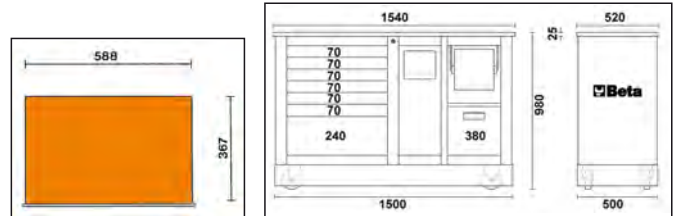

C39MD

Spezieller Werkzeugwagen vom Typ Racing MD

Technische Merkmale

- Arbeitsfläche aus Multiplexplatte
- 4 Räder Ø 125 mm
- 2 starre und 2 lenkbare (eins mit Bremse) mit Schutzabdeckung
- Statische Belastung: 1200 kg

Modul mit 7 Schubladen

mit Teleskopführungen, kugelgelagert, 588x367 mm:

- 6 Schubladen Höhe 70 mm
- 1 Schublade Höhe 240 mm
- Schubladenböden mit Schaumgummibelag
- Zentralverriegelung mit vorderem Sicherheitsschloss
- Über die gesamte Schubladenlänge positioniertes Öffnungssystem
- Schubladenfront aus Aluminium

Modul mit 2 Schubladen

mit Teleskopführungen, kugelgelagert, 588x367x270 mm und 588x367x380 mm,

- Schubladenböden mit Schaumgummibelag
- Zentralverriegelung mit vorderem Sicherheitsschloss
- Über die gesamte Schubladenlänge positioniertes Öffnungssystem
- Schubladenfront aus Aluminium

123 kg

		€	1	
C39MD-O	RAL 2011	3.730,00	1	039390101
C39MD-G	RAL 7016	3.730,00	1	039390102
C39MD-R	RAL 3000	3.730,00	1	039390103

1200 kg



C39MD-G

C39MD-R

C39MD-O



h	max
70 mm	30 kg
240 mm	40 kg

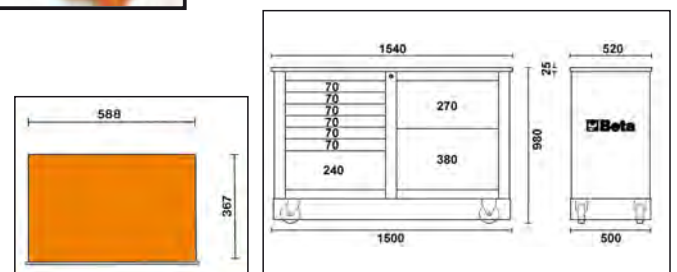

C41S

Trolley mit zwei stapelbaren Modulen

Haupteigenschaften:

- Rahmen aus Blech und Kunststoffablagen: äußerst robust und gewichtsreduziert.
- 2 getrennte Module: 1 oberer Korb, 1 Modul mit 1 95 mm und 1 295 mm hohen Schublade.
- Große Räder (160 mm), für einen einfacheren Transport auch auf Treppen in die Struktur integriert.
- Zentralverschluss, seitlich, zum Schließen der 2 Schubladen des unteren Moduls.
- Schubladen mit Teleskopführungen, kugelgelagert, mit doppeltem Verschlusshaken.
- Teleskopgriff aus Aluminium.
- Integrierte Kunststoffschale für Kleinteile im oberen Korb.
- Untere Schublade mit doppelter Teleskopführung

Empfohlene Sortimente: 5940/SBK und 5915VU/5

16 kg

C41S € 667,00 1 041000001

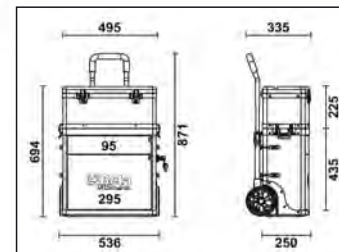
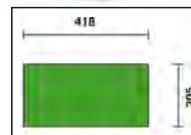

C41H

Trolley mit zwei stapelbaren Modulen

Haupteigenschaften:

- Rahmen aus Blech und Kunststoffablagen: äußerst robust und gewichtsreduziert.
- 2 getrennte Module: 1 oberer Korb, 1 Modul mit 2 95 mm hohen Schubladen, 1 66 mm hohen herausziehbaren Kunststoffkasten und 1 295 mm hohen Schublade.
- Große Räder (160 mm), für einen einfacheren Transport auch auf Treppen in die Struktur integriert.
- Zentralverschluss, seitlich, zum Schließen der 2 Schubladen des unteren Moduls.
- Schubladen mit Teleskopführungen, kugelgelagert, mit doppeltem Verschlusshaken.
- Teleskopgriff aus Aluminium.
- Integrierte Kunststoffschale für Kleinteile im oberen Korb.
- Untere Schublade mit doppelter Teleskopführung

• Empfohlene Sortimente: 5941VU/M, 5940/SBK und 5915VU/5

* Farben auf Anfrage verfügbar

21 kg

		€		
C41H-O	RAL 2011	695,00	1	041000002
C41H-N	RAL 9005	695,00	1	041000005
C41H-B	RAL 5002	695,00	1	041000006
C41H-R	RAL 3000	695,00	1	041000008
C41H-G	RAL 7016	695,00	1	041000010
C41H-Y	RAL 1023	695,00	1	041000012
C41H-W	RAL 9016	695,00	1	041000021
C41H-V	RAL 6016	695,00	1	041000024



C41H-O



C41H-W

C41H-Y

C41H-R

C41H-V

C41H-B

C41H-G

C41H-N

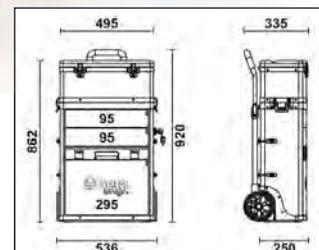
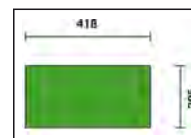

C41H/CE

Werkzeugkasten mit herausnehmbaren Trennvorrichtungen für Kleinteile aus Kunststoff

1,3 kg

C41H/CE € 43,50 1 041000916



C42H

Trolley mit 3 stapelbaren Modulen

Haupteigenschaften:

- Rahmen aus Blech und Kunststoffablagen: äußerst robust und gewichtsreduziert.
- 3 getrennte Module:
 - 1 oberer Korb, Höhe 220 mm
 - 1 zentrales Werkzeugmodul, Höhe 180 mm
 - 1 unteres Werkzeugmodul mit Rädern, Höhe 330 mm.
- Räder mit großem Durchmesser (ø 160 mm).
- In 3 Positionen arretrierbarer Teleskopgriff
- Schnellauslösende Module: praktischer und schneller Zugriff auf die verschiedenen Werkzeugfächer.
- Oberer Korb mit internem Aufbewahrungsfach und 3 im Deckel integrierte Schalen zur Aufnahme von Kleinteilen.
- Kann auch nur mit 2 Modulen benutzt werden.

Empfohlene Sortimente: 5940/SBK und 5915VU/5

14 kg

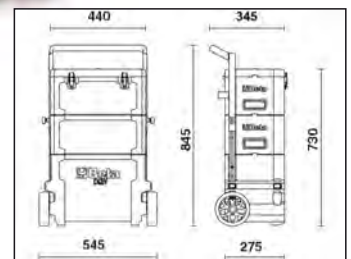

C42H

€ 494,00 1 042000002

Beta

CX49-G

Multifunktionswagen

**Nutzbar als mobile Arbeitsstation
für Diagnosegeräte, Laptop, Tester und Batterieladegeräte.**

EIGENSCHAFTEN

- Struktur aus lackiertem Blech: maximale Stabilität und Festigkeit
- Ergonomischer Griff
- Obere Ablage auf 2 Ebenen
- Ausziehbare Schublade für Mini-Tastatur
- 2 zentrale Ablagen mit verstellbarer Position und 1 niedrige feste Ablage
- 4 nützliche Kabelaufroller seitlich aus Kunststoff
- 2 praktische Behälter seitlich
- 2 feste Hinterräder Ø 160 mm
- 2 drehbare Vorderräder Ø 100 mm (eins mit Bremse)
- Gewicht: 36 kg

CX49-G

€ 916,00 1 049000102

1099 mm
460 mm
435 mm



CA49-G

Multifunktionswagen mit Tür

**Nutzbar als mobile Arbeitsstation
für Diagnosegeräte, Laptop, Tester und Batterieladegeräte.**

EIGENSCHAFTEN

- Struktur aus lackiertem Blech: maximale Stabilität und Festigkeit
- Ergonomischer Griff
- Obere Ablage auf 2 Ebenen
- Ausziehbare Schublade Mini-Tastatur
- 1 Ablage mit verstellbarer Position, 1 feste Ablage und Tür
- 4 nützliche Kabelaufroller seitlich aus Kunststoff
- 2 praktische Behälter seitlich
- 2 feste Hinterräder Ø 160 mm
- 2 drehbare Vorderräder Ø 100 mm (eins mit Bremse)
- Gewicht: 36,5 kg

CA49-G

€ 1.029,00 1 049000112

1099 mm
460 mm
435 mm



4900-COVER C49

Nylonschutzabdeckung für Multifunktionswagen Art. C49

4900-COVER C49

€ 43,50 1 049000930



C48M

Elektro-Plattformwagen, mit Seitenwänden

Die reduzierten Abmessungen und die Vielseitigkeit des Einsatzes machen den Plattformwagen C48M ideal zur Beförderung in elektrisch unterstützter Betriebsart auch von schweren Teilen (Schachteln, Container, sperrige Gegenstände, Ausrüstungskomponenten) bei absoluter Sicherheit, selbst in schwer zugänglichen Zonen und in Werksbereichen, in denen keine Gabelstapler eingesetzt werden können. Das Ergebnis ist eine deutliche Reduzierung der Verletzungsgefahr für die Arbeitskräfte, wie z.B. einer durch die manuelle Lastenbewegung entstehenden Gefahr einer Verletzung der Skelettmuskulatur.

Motorisierte Ladefläche mit Motor 24 V- 400 W, Stromversorgung über Batterie 2x12V 33Ah und Steuerkarte Curtis.

Ladefläche aus solidem Stahl, verkleidet mit rutschfestem Gummi, mit Seitenwänden aus Rohr mit rundem Querschnitt für sicheren Lastentransport.

Die Rohre der Seitenwände können zwecks Anpassung an die jeweiligen Transportbedingungen abgenommen werden.

Ausstattung der Steuerkonsole:

- Einschaltsschlüssel
- Geschwindigkeitsregler
- Seitenklappen zur Zugkontrolle
- Intermittierender Akustikmelder zur Warnanzeige "Rückwärtsgang"
- Anzeige des Ladezustands der Batterie
- Taste zum Ausschluss der Elektrobremse
- Notaus-Pilzschalter

Ausgestattet mit 2 pneumatischen Zugrädern (Ø 260 mm) und mit 2 mit Gummi-Lenkrollen (Ø 150 mm), elektromagnetischer Bremse und Differential.

Externes Batterieladegerät 220V/50Hz-V/A24/12, zum Lieferumfang gehörig

KENNDATEN

Max. Belastung: 400 kg

Fahrgeschwindigkeit: 4-6 km/h (einstellbar)

Autonomie: 4 Stunden

Max. Steigung bei voller Last: 6%

Max. Steigung bei Last 100 kg: 18%

Sicherheitseinrichtungen:

- Elektronische Bremse
- Akustikmelder
- Quetschschutz
- Anzeige des Ladezustands der Batterie
- Steuerkarte Curtis

TECHNISCHE DATEN

Außenabmessungen: 1280x630x1100 (H) mm

Nutzabmessungen Ladefläche mit Seitenwänden: 1180x580 mm

Nutzabmessungen Ladefläche ohne Seitenwände: 1260x620 mm

Höhe Ladefläche, ab Fußboden: 320 mm

Höhe Batteriefach, ab Fußboden: 65 mm

Gewicht, mit Batterien: 140 kg

Beta
BRUTUS

400
kg

CE



1100
630
1280

140 kg

C48M

€ 3.340,00



1



048000230

C48P

Klappwagen

Haupteigenschaften:

- Ladebühne aus verstärktem Polypropylen (PP), mit rutschfester Beschichtung und TPV-Einsätzen zum Kantenschutz
- Zusammenklappbarer Griff für eine schnelle und platz sparende Lagerung
- 4 abriebfeste Räder Ø 125 mm: 2 starre und 2 lenkbare mit Bremse
- Maximale Tragfähigkeit: 300 kg.
- Nutzbreite der Ladebühne: 705 mm
- Tiefe der Ladebühne: 480 mm
- Höhe der Ladebühne: 200 mm



300
kg



11 kg

C48P

€ 314,00



1

048000030

C51

Werkzeugwagen

- 3 mit rutschfestem Riffelgummi bedeckte Einlegeböden
- Ergonomischer Griff
- Doppelte Befestigungsmöglichkeit des mittleren Einlegebodens
- Vier Räder Ø 100 mm:
- 2 starre und 2 lenkbare Räder (eins mit Bremse).

21 kg



		€		
C51 O	RAL 2011	350,00	1	051000001
C51 G	RAL 7016	350,00	1	051000002
C51 R	RAL 3000	350,00	1	051000003

RSC51

Werkstatt-Servicewagen mit 3 Schubladen

Hauptmerkmale:

- ABS-verstärkte Arbeitsplatte, fest und robust
- Multifunktionale Auflagefläche mit Seitenwänden zum Sturzschutz und 8 Löchern zur Aufnahme der Schraubendreher
- 3 Schubladen mit Teleskopführungen, kugelgelagert 588x367 mm, Höhe 70 mm
- Schubladenböden mit Schaumgummibelag
- Jede Schublade kann bis zu 4 Schaumstoffeinsätze aus EVA oder feste Thermoformateinsätze aus ABS aufnehmen
- Zentralverriegelung mit vorderem Sicherheitsschloss
- Mit praktischem seitlichem Schraubendreherhalter
- Zwei seitliche Dosenhalter, an der Struktur integriert
- Große untere Ablage, mit öl- und benzinfester Gummischutzmatte
- Vier Räder Ø 125 mm: 2 fest und 2 drehbar (davon 1 gebremst)

- Statische Belastung: 400 kg
- Tragkraft jeder Schublade: 15 kg, Gewicht muss gleichmäßig verteilt sein

38 kg



h	max
70 mm	15 kg

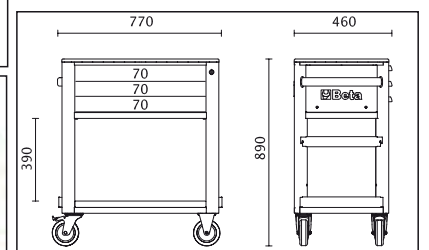
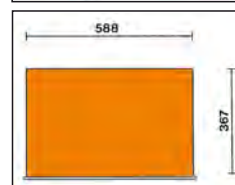

		€		
RSC51-FO	RAL 2011	698,00	1	051000300
RSC51-R	RAL 3000	698,00	1	051000303
RSC51-A	RAL 7016	698,00	1	051000307

2400 RSC24/MP

Klappbares Regal für Art. RSC24, RSC24A, RSC24AXLP/7, RSC51

- Verwendbar als zusätzliche Arbeitsablage
- Arbeitsfläche, 390x440 mm, geschützt mit öl- und benzinfestem Gummibelag
- Tragfähigkeit: 20 kg

3,4 kg



2400 RSC24/MP

€ 87,50 1 024004900

CP51

Hoch widerstandsfähiger Werkzeugwagen

- 2 Ablageplatten mit Einlegebögen aus Gummi
- Ergonomischer Griff
- Vier Räder Ø 125 mm, hoch widerstandsfähig: 2 starre und 2 lenkbare mit Bremse
- Statische Tragkraft: 750 kg (verteilt auf die 2 Ablageplatten)

37 kg

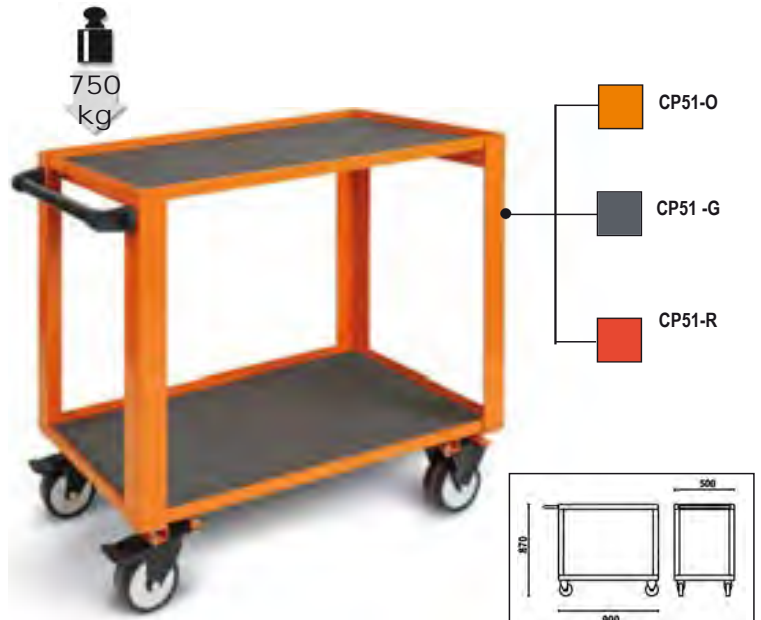

CP51 O	RAL 2011	€ 463,00	1	051000501
CP51 G	RAL 7016	€ 463,00	1	051000502
CP51 R	RAL 3000	€ 463,00	1	051000503

CB52

Wagen für Getriebe/Antriebe mit Auffangbehälter für Flüssigkeiten

Die schräge Ablageplatte und die Ablauföffnungen ermöglichen das Auffangen der Flüssigkeiten direkt in den Auffangbehälter

Ausgestattet mit:

- 4 drehbare Räder, 2 mit Bremse
- Werkzeugschublade
- Ausziehbarer Auffangbehälter mit 7 l
- 2 Einlegeböden

Abmessungen: 1200x640x870 mm
Gewicht: 60 kg

60 kg



CB52-O

€ 884,00 1 052000201

C56P 0

Klappbare Werkbank

Kompakt und mühelos transportierbar.
Arbeitsplatte 800x500mm (Dicke 30 mm) aus MDF und verzinktem Blech,
beidseitig verwendbar.
Griff mit Gummischutz für einen praktischen Transport.
Stellfüße mit rutschfester Beschichtung.
Statische Belastung: 250 kg

18,5 kg



250
kg

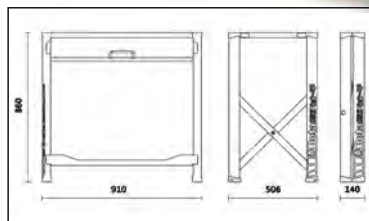

C56P 0

€ 487,00 1 056000011

C56PL 0

Klappbare Werkbank, Version Light

Leicht, kompakt und mühelos transportierbar.
Arbeitsplatte 800x500mm aus verzinktem Blech, nur einseitig verwendbar,
geschützt mit öl- und benzinfestem Gummibelag.
Griff mit Gummischutz für einen praktischen Transport.
Stellfüße mit rutschfester Beschichtung.
Statische Belastungskapazität: 200 kg

18,5 kg



200
kg

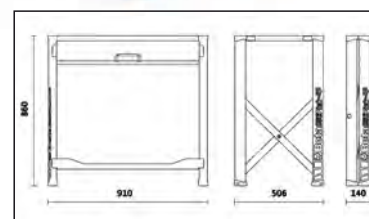

C56PL 0

€ 421,00 1 056000021

C54S

Werkzeugschränke Cargo

In Zusammenarbeit mit qualifizierten professionellen Anwendern entwickelt, stellen sie die ideale Lösung für komfortables und rationelles Arbeiten dar. Das Öffnen der Lochtafeln beider Türen ermöglicht die Nutzung auch der Innenfläche.

Haupteigenschaften:

- 1 Schublade mit teleskopischen Führungen.
- Leichte Änderung der Anordnung der Werkzeuge nach den jeweiligen Bedürfnissen möglich.
- Wandbefestigung mit Hilfe von zwei Langlöchern auf der Rückseite.
- Sicherheitsschloss zum gleichzeitigen Verschießen von Türen und Schublade.
- Thermoformateinsatz für Steckschlüssel und Zubehör 1/2" leer.



37 kg

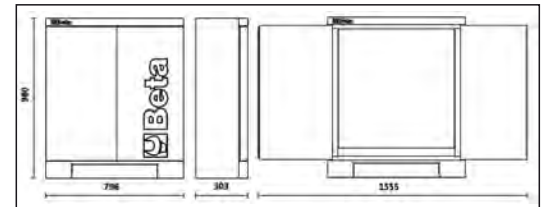

C54S-O

RAL 2011

€ 884,00

1

054000301

Beta

C57SA

Werkbank MasterCargo

- Modell mit Werkzeugwand (C57P) und einem Schubladenblock.

Schubladenblock bestehend aus 5 Schubladen mit den Maßen 588x367 mm, 3 Schubladen mit Höhe 90 mm, 1 Schublade mit Höhe 180 mm und 1 Schublade mit Höhe 280 mm, mit Teleskopführungen, kugelgelagert. Ausgelegt zum Einfügen von Thermoformateinsätzen. Zentralverriegelung.

Werkzeugwand mit Langlöchern auch zum Aufhängen. Aluminiumjalousie, vertikal manövrierbar, mit Sicherheitsschloss. Drei abnehmbare Lochtafeln zur Unterbringung der Werkzeuge.

Arbeitsplatte aus Multiplexplatte, laminatbeschichtet, mit drei Bohrungen, zur Befestigung eines Schraubstocks 1599F/150 - 1599GI/150 (separat zu bestellen).

📦 205 kg



C57SA-O



C57SA-G

C57SA-R

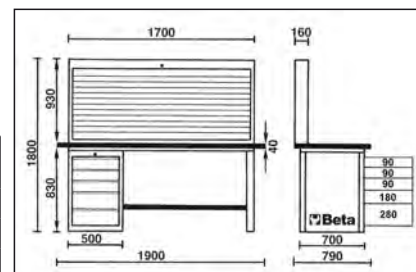

h	max
90 mm	30 kg
180 mm	40 kg
280 mm	40 kg

		€	📦	🏠
C57SA-O	RAL 2011	5.550,00	1	057001005
C57SA-G	RAL 7016	5.550,00	1	057001205
C57SA-R	RAL 3000	5.550,00	1	057001405

C57SD

Werkbank MasterCargo

- Modell mit einem Schubladenblock.

Schubladenblock bestehend aus 5 Schubladen mit den Maßen 588x367 mm, 3 Schubladen mit Höhe 90 mm, 1 Schublade mit Höhe 180 mm und 1 Schublade mit Höhe 280 mm, mit Teleskopführungen, kugelgelagert. Ausgelegt zum Einfügen von Thermoformateinsätzen. Zentralverriegelung.

Arbeitsplatte aus Multiplexplatte, laminatbeschichtet, mit drei Bohrungen, zur Befestigung eines Schraubstocks 1599F/150 - 1599GI/150 (separat zu bestellen).

📦 158 kg



C57SD-O



h	max
90 mm	30 kg
180 mm	40 kg
280 mm	40 kg

		€	📦	🏠
C57SD-O	RAL 2011	3.920,00	1	057001004
C57SD-G	RAL 7016	3.920,00	1	057001204
C57SD-R	RAL 3000	3.920,00	1	057001404

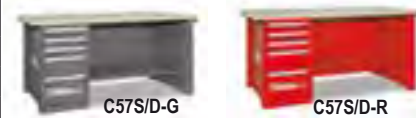

C57SD-G

C57SD-R

C57SB

Werkbank MasterCargo

- Modell mit Werkzeugwand (C57P) und zwei Schubladenblöcken.

Schubladenblock bestehend aus 5 Schubladen mit den Maßen 588x367 mm, 3 Schubladen mit Höhe 90 mm, 1 Schublade mit Höhe 180 mm und 1 Schublade mit Höhe 280 mm, mit Teleskopführungen, kugelgelagert.

Ausgelegt zum Einfügen von Thermoformateinsätzen. Zentralverriegelung.

Werkzeugwand mit Langlöchern auch zum Aufhängen. Aluminiumjalousie, vertikal manövrierbar, mit Sicherheitsschloss. Drei abnehmbare Lochtafeln zur Unterbringung der Werkzeuge.

Arbeitsplatte aus Multiplexplatte, laminatbeschichtet, mit drei Bohrungen, zur Befestigung eines Schraubstocks 1599F/150 - 1599GI/150 (separat zu bestellen).

📦 243 kg



1800 kg



C57S/B-G



C57S/B-R

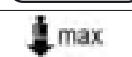

h	max
90 mm	30 kg
180 mm	40 kg
280 mm	40 kg

1700	160
930	1800
830	700
500	1900
500	790
	90
	90
	90
	180
	280

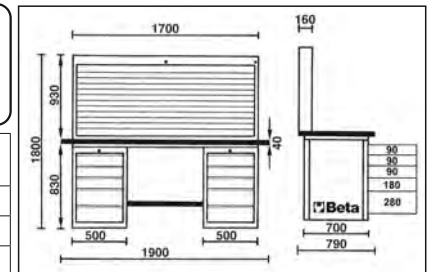

		€	📦	🖨️
C57S/B-O	RAL 2011	6.920,00	1	057001006
C57S/B-G	RAL 7016	6.920,00	1	057001206
C57S/B-R	RAL 3000	6.920,00	1	057001406

C57SC

Werkbank MasterCargo

- Modell mit zwei Schubladenblöcken.

Schubladenblock bestehend aus 5 Schubladen mit den Maßen 588x367 mm, 3 Schubladen mit Höhe 90 mm, 1 Schublade mit Höhe 180 mm und 1 Schublade mit Höhe 280 mm, mit Teleskopführungen, kugelgelagert.

Ausgelegt zum Einfügen von Thermoformateinsätzen. Zentralverriegelung.

Arbeitsplatte aus Multiplexplatte, laminatbeschichtet, mit drei Bohrungen, zur Befestigung eines Schraubstocks 1599F/150 - 1599GI/150 (separat zu bestellen).

📦 196 kg



1800 kg

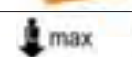

h	max
90 mm	30 kg
180 mm	40 kg
280 mm	40 kg

1700	160
930	1800
830	700
500	1900
500	790
	90
	90
	90
	180
	280



		€	📦	🖨️
C57S/C-O	RAL 2011	5.290,00	1	057001003
C57S/C-G	RAL 7016	5.290,00	1	057001203
C57S/C-R	RAL 3000	5.290,00	1	057001403

C57SP

Werkzeugwand MasterCargo

Werkzeugwand mit Langlöchern auch zum Aufhängen.
Aluminiumjalousie, vertikal manövrierbar, mit Sicherheitsschloss.
Drei abnehmbare Lochtafeln zur Unterbringung der Werkzeuge

46 kg

		€		
C57SP-O	RAL 2011	1.630,00	1	057001020
C57SP-G	RAL 7016	1.630,00	1	057001220
C57SP-R	RAL 3000	1.630,00	1	057001420



C57SP O



C57SP G



C57SP R

5700LAMP

Lampe für Werkbank MasterCargo

- Robuster Stahlblechaufbau mit vier Bestandteilen; komplett mit Schrauben zur Montage geliefert.
- Fassung mit LED-Band, 1120 Lumen, 4000K, 14W.
- Netzanschluss: 230 V.
- Ohne Kabel geliefert.

9 kg

	€		
5700LAMP	402,00	1	057000005



C58P

Werkzeugwand

- Modell mit Jalousieverschluss aus lackiertem Aluminium und Sicherheitsschloss.
- Zwei abnehmbare Lochtafeln zur Unterbringung der Werkzeuge.

46,8 kg

		€		
C58P-O	RAL 2011	1.235,00	1	058000221
C58P-G	RAL 7016	1.235,00	1	058000222
C58P-R	RAL 3000	1.235,00	1	058000223



C58P-G



C58P-R



C58P-O

PV

Werkzeugtafel für Wandbefestigung

	LxA mm	€		
PV1	1000x920 10,2	232,00	1	088880010
PV1,5	1500x920 14,2	306,00	1	088880015



C56W

Werkbank mit Arbeitsfläche aus Holz

- Arbeitsfläche aus Mehrschichtholz mit Bohrungen zur Aufnahme eines Schraubstocks 1599F/125 - 1599GI/125 (separat zu bestellen)
- Stahlstruktur mit 6 Stützbeinen
- Statische Belastung: 1.200 kg
- Mit der Werkzeugwand C57P kombinierbar, nicht am Arbeitstisch befestigbar.
- Zwei Schubladen mit Verschluss.
- Ausgelegt zur Befestigung am Boden.

86 kg



		€		
C56W-O	RAL 2011	1.365,00	1	056000251
C56W-G	RAL 7016	1.365,00	1	056000252
C56W-R	RAL 3000	1.365,00	1	056000253

C56B

Werkbank mit Arbeitsfläche aus Holz

Haupteigenschaften:

- Arbeitsfläche aus Mehrschichtholz mit Bohrungen zur Aufnahme eines Schraubstocks 1599F/125 - 1599GI/125 (separat zu bestellen)
- Stahlstruktur mit 4 Stützbeinen
- Statische Belastung: 800 kg
- Unteres Aufbewahrungsfach
- Ausgelegt zur Befestigung am Boden

54,5 kg



		€		
C56B-O	RAL 2011	810,00	1	056000401
C56B-G	RAL 7016	810,00	1	056000402
C56B-R	RAL 3000	810,00	1	056000403

C56

Werkbank

- Arbeitsplatte aus lackiertem Blech mit Außenrand
- Stahlstruktur mit 6 Stützbeinen
- Statische Belastung: 1.200 kg
- Mit der Werkzeugwand C57P kombinierbar, nicht am Arbeitstisch befestigbar.
- Zwei Schubladen mit Schloss.
- Vorrichtung zur Befestigung am Boden.

82 kg



		€		
C56-O	RAL 2011	1.148,00	1	056000201
C56-G	RAL 7016	1.148,00	1	056000202
C56-R	RAL 3000	1.148,00	1	056000203

C56M

Werkbank

- Arbeitsplatte aus Metall, zur Hälfte mit rutschfester Aluminiumplatte und zur Hälfte mit Gummibelag.
- Unterplatte aus Kernholz.
- Belastung kg.800.
- Mit der Werkzeugwand Art. C57P anwendbar.
- Drei Schubladen mit Schloss.



95 kg

		€		
C56M O	RAL 2011	1.660,00	1	056000050
C56M G	RAL 7016	1.660,00	1	056000053
C56M R	RAL 3000	1.660,00	1	056000054

C58B

Werkbank mit Arbeitsfläche aus Holz

Haupteigenschaften:

- Arbeitsfläche aus Mehrschichtholz mit Bohrungen zur Aufnahme eines Schraubstocks 1599F/125 - 1599GI/125 (separat zu bestellen).
- Stahlstruktur mit 4 Stützbeinen
- Statische Belastung: 800 kg
- Unteres Aufbewahrungsfach
- Ausgelegt zur Befestigung am Boden



44 kg

		€		
C58B-O	RAL 2011	726,00	1	058000401
C58B-G	RAL 7016	726,00	1	058000402
C58B-R	RAL 3000	726,00	1	058000403

C58M

Werkbank

- Arbeitsplatte aus Metall, komplett mit einem rutschfesten, abnehmbaren Gummibelag abgedeckt.
- Ablage aus Massivholz.
- Statische Belastung: 800 kg.
- Kann mit der Werkzeugwand Art. C58P kombiniert werden, nicht an der Arbeitsplatte montierbar.
- 2 Schubladen mit Schloss.
- Ausgelegt auf die Befestigung am Fußboden.
- Ausgelegt auf die Anbringung der Arbeitsplatte aus Aluminium Art. C58M/PA (optional).



65 kg

		€		
C58M-O	RAL 2011	1.068,00	1	058000300
C58M-G	RAL 7016	1.068,00	1	058000302
C58M-R	RAL 3000	1.068,00	1	058000303

C59A

Werkbank "Endurance" mit 1 Schubladenblock bestehend aus sechs Schubladen

Haupteigenschaften:

- Multiplex-Arbeitsplatte mit Bohrungen zur Aufnahme eines Schraubstocks 1599F/125 - 1599GI/125 (separat zu bestellen).
- 6 Schubladen mit Teleskopführungen, kugelgelagert, 588x367 mm:
- 4 Schubladen Höhe 70 mm
- 1 Schublade Höhe 140 mm
- 1 Schublade Höhe 280 mm.
- Schubladenböden mit Schaumgummibelag.
- Frontblende der Schubladen aus hochbeständigem Nylon.
- Schubladen ausgelegt für das Einfügen von Thermoformateinsätzen.
- Zentralverriegelung mit vorderem Sicherheitsschloss.
- Unteres Aufbewahrungsfach.
- Ausgelegt für Montage des Papierrollenhalters (2400 RSC24/PC) und Flaschenhalters (2400 RSC24/PF-), separat zu bestellen.

115 kg



h	max
70 mm	25 kg
140 mm	30 kg
280 mm	35 kg

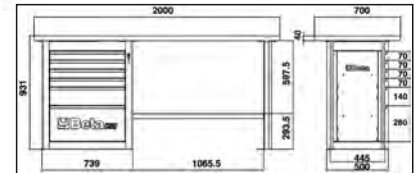

		€		
C59A-O	RAL 2011	2.185,00	1	059000011
C59A-A	RAL 7016	2.185,00	1	059000031
C59A-R	RAL 3000	2.185,00	1	059000051

C59B

Werkbank "Endurance" mit 2 Schubladenblöcken bestehend aus sechs Schubladen

Haupteigenschaften:

- Multiplex-Arbeitsplatte mit Bohrungen zur Aufnahme eines Schraubstocks 1599F/125 - 1599GI/125 (separat zu bestellen).
- 12 Schubladen, 588x367 mm, mit Teleskopführungen, kugelgelagert:
- 8 Schubladen Höhe 70 mm
- 2 Schubladen Höhe 140 mm
- 2 Schubladen Höhe 280 mm
- Schubladenböden mit Schaumgummibelag.
- Schubladen ausgelegt für das Einfügen von Thermoformateinsätzen.
- Zentralverriegelung mit vorderem Sicherheitsschloss.
- Unteres Aufbewahrungsfach.
- Ausgelegt für Montage des Papierrollenhalters (2400 RSC24/PC) und Flaschenhalters (2400 RSC24/PF-), separat zu bestellen.

155 kg



h	max
70 mm	25 kg
140 mm	30 kg
280 mm	35 kg

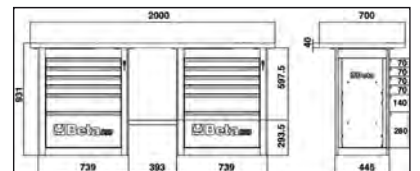

		€		
C59B-O	RAL 2011	2.900,00	1	059000012
C59B-R	RAL 3000	2.900,00	1	059000052
C59B-A	RAL 7016	2.900,00	1	059000032

C59C

Werkbank "Endurance" mit 1 Schubladenblock bestehend aus sechs Schubladen, kurze Ausführung

Haupteigenschaften:

- Multiplex-Arbeitsplatte mit Bohrungen zur Aufnahme eines Schraubstocks 1599F/125 - 1599GI/125 (separat zu bestellen).
- 6 Schubladen, 588x367 mm, mit Teleskopführungen, kugelgelagert:
4 Schubladen Höhe 70 mm
1 Schublade Höhe 140 mm
1 Schublade Höhe 280 mm
- Schubladenböden mit Schaumgummibelag.
- Schubladen ausgelegt für das Einfügen von Thermoformateinsätzen.
- Zentralverriegelung mit vorderem Sicherheitsschloss.
- Unteres Aufbewahrungsfach.
- Ausgelegt für Montage des Papierrollenhalters (2400 RSC24/PC) und Flaschenhalters (2400 RSC24/PF-), separat zu bestellen.

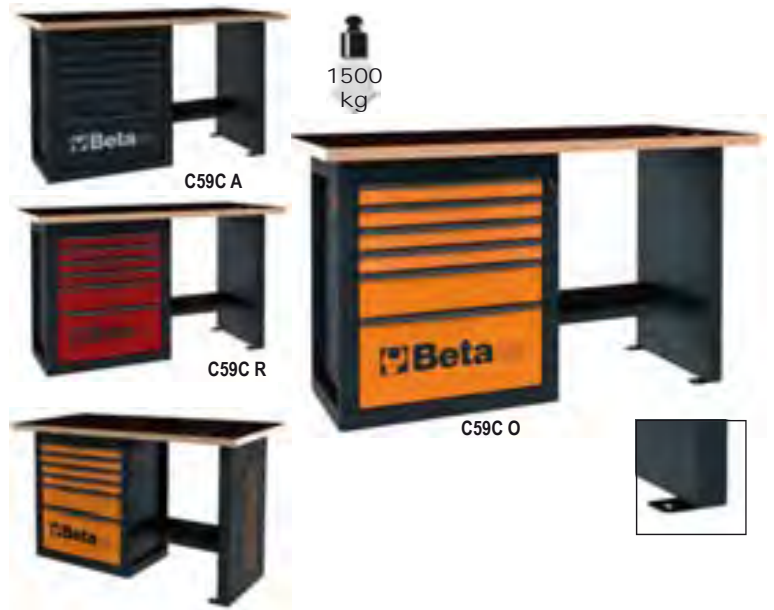

105 kg

		€	1	059000013
C59C-O	RAL 2011	1.975,00	1	059000013
C59C-R	RAL 3000	1.975,00	1	059000053
C59C-A	RAL 7016	1.975,00	1	059000033

h	max
70 mm	25 kg
140 mm	30 kg
280 mm	35 kg

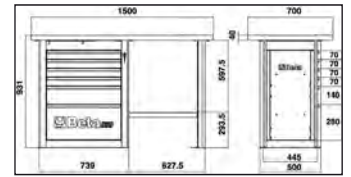

9562T2

Teppich für Werkbank 200x160 cm

- Schützt den Boden vor Öl- und Benzinleckagen und schützt die Umwelt
- Leicht zu säubern, Bodenseite aus Gummi und rutschfest



	L cm	€	1	095620200
9562T2	200	271,00	1	095620200

 **Beta**



WERKSTATTEINRICHTUNG



Beta Utensili hat "Racing System C55" geschaffen, um den Ansprüchen eines Marktes, der immer mehr Qualität, Design und Personalisierung erfordert, gerecht zu werden: eine modulare Werkstatteinrichtung, die Ihnen die Gestaltung einer modernen und auf Ihre Anforderungen ausgerichteten Arbeitsumgebung ermöglicht.

Qualität

Die beste Beta Qualität "Made in Italy", um Ihre Werkstatt einzurichten

Organisation

Ein rationell organisierter Arbeitsplatz zur Optimierung der Arbeit



Modularität

Werkstattgestaltung auf der Grundlage Ihrer Räume und Ansprüche

Design

Ausgeklügelte und raffinierte Endverarbeitung, um den Arbeitsplatz ordentlich und angenehm zu gestalten





MADE IN ITALY



konfigurieren Sie on-line Ihre Werkstatt
www.rsc55.com



Die Werkstatt mit Ihren Farben!

RSC55 bietet Ihnen die Möglichkeit, die Werkbänke und die Wand mit Rollladen in neutraler Ausführung (grau) zu bestellen und Ihre Personalisierung mit den vertikalen bunten Einsätzen, die unter 4 unterschiedlichen Klebebandern zu bestellen sind, zu bestellen.

**1. Bestellen Sie Ihre
Module mit neutraler Farbe**

2. Bestellen Sie den vertikalen Einsatz

Wählen Sie die Farbe je nach Ihrem Geschmack oder gemäß den Farben Ihres Betriebs aus.

C55 Komplette Kombi-Werkstatteinrichtung

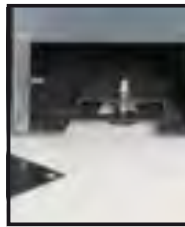

Komplette Kombi-Werkstatteinrichtung bestehend aus:

- 1-türiger Schrank (C55A1)
- 2-türiger Schrank (C55A2)
- Werkbank (C55BO/2)
- Werkbank mit Steckdosen (C55PRO BO/2)
- Werkzeugwagen mit 7 Schubladen (C55C7)
- Festes Modul mit 2 großen Schubladen (C55M2)
- Festes Modul mit 7 Schubladen (C55M7)
- Festes Servicemodul (C55MS)
- Wand mit Hängeschränken (C55/2PM)
- Werkzeugwand mit Rollladen (C55PS-O)

C55AB

Kombi-Werkstatteinrichtung

Kombi bestehend aus:

- 2-türiger Schrank (C55A2)
- Werkbank (C55BO/2)
- Festes Modul mit 7 Schubladen (C55M7)
- Festes Servicemodul (C55MS)
- Wand mit Hängeschränken (C55/2PM)

407 kg



C55AB

€ 10.800,00 1 055000020



C55PB/3

Kombi-Werkstatteinrichtung

Kombi bestehend aus:

- Werkbank (C55BO/2)
- Modul Werkzeugwagen mit 8 Schubladen (C55C8)
- Festes Modul mit 2 großen Schubladen (C55M2)
- Werkzeugwand mit Rollladen (C55PS-O)

334 kg



C55PB/3

€ 9.100,00 1 055000035



C55PB-PRO/7

Arbeitsplatz für Werkstatteinrichtung RSC55

Bestehend aus:

C55B

Werkbank mit Arbeitsplatte 2050x700 mm, verkleidet mit einer stoß- und kratzfesten ABS-Schicht, öl- und kohlenwasserbeständig.

Ausgestattet mit:

- Bohrungen zum Einbringen eines Schraubstocks (1599F/150, separat zu bestellen)
- höhenverstellbaren Füßen

C55M7

Festes Modul mit sieben Schubladen mit Teleskopführungen, kugelgelagert, 588x367 mm

- Über die gesamte Schubladenlänge positioniertes Öffnungssystem aus Aluminium

- Schubladenböden mit Schaumgummibelag

- Zentralverriegelung mit vorderem Schloss

- Ausgelegt zum Einfügen von Thermoformateinsätzen

C55MS

Festes Servicemodul

- Eingebauter Mülleimer

- Papierrollenfach, für vorgelochte Rollen

- Großes Ablagefach, 305x270 mm

C55/2PM + C55/PF

Wand mit 2 Hängeschränken

- 2 Hängeschränke, 1024x400x300 mm, mit Gasdruckfedern

- 2 Paneele unter Hängeschränk, 1024x620x25 mm

- 2 Lochplatten unter Hängeschränk, 1024x620x25 mm, zur Unterbringung der Werkzeuge

350 kg



C55PB-PRO/7

€ 10.210,00 1 055000065



C55PB-PRO/8

Arbeitsplatz für Werkstatteinrichtung RSC55

Bestehend aus:

C55B

Werkbank mit Arbeitsplatte 2050x700 mm, verkleidet mit einer stoß- und kratzfesten ABS-Schicht, öl- und kohlenwasserbeständig.

Ausgestattet mit:

- Bohrungen zum Einbringen eines Schraubstocks (1599F/150, separat zu bestellen)
- höhenverstellbaren Füßen

C55C7

Werkzeugwagen mit sieben Schubladen mit Teleskopführungen, kugelgelagert, 588x367 mm

- 4 Räder Ø 100 mm: 2 fest und 2 drehbar (davon 1 gebremst)

- Über die gesamte Schubladenlänge positioniertes Öffnungssystem aus Aluminium

- Schubladenböden mit Schaumgummibelag

- Zentralverriegelung mit vorderem Schloss

- Ausgelegt zum Einfügen von Thermoformateinsätzen

C55MA

Festes Modul mit 2 Türen

- Öffnen durch ein Push-Pull-System

- Mit Schloss

- Höhenverstellbare interne Ablage

C55PS

Werkzeugwand mit Rollladen und Trägerstruktur

- Aluminiumrollladen, vertikal manövrierbar, mit Schloss

- Abnehmbare Lochplatte zur Unterbringung der Werkzeuge

347 kg



C55PB-PRO/8

€ 8.790,00 1 055000066



C55B/2

Werkbank 2 Meter lang für Werkstatteinrichtung

Mit Arbeitsfläche 2050x700 mm, verkleidet mit einer stoß- und kratzfesten PVC-Schicht, kohlenwasserstoffbeständig

- Bohrungen zum Einbringen eines Schraubstocks 1599F/150 - 1599GI/150 (separat bestellbar)
- Höhenverstellbare Füßen

105 kg

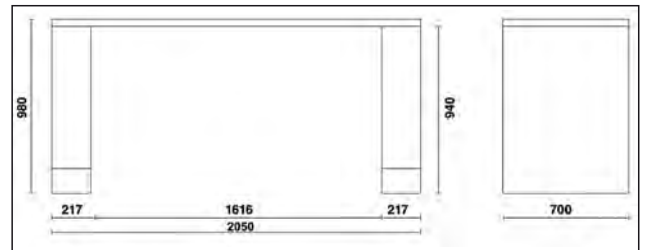
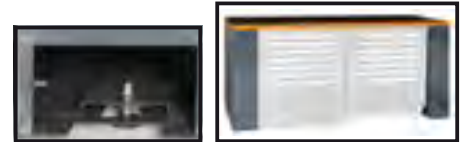
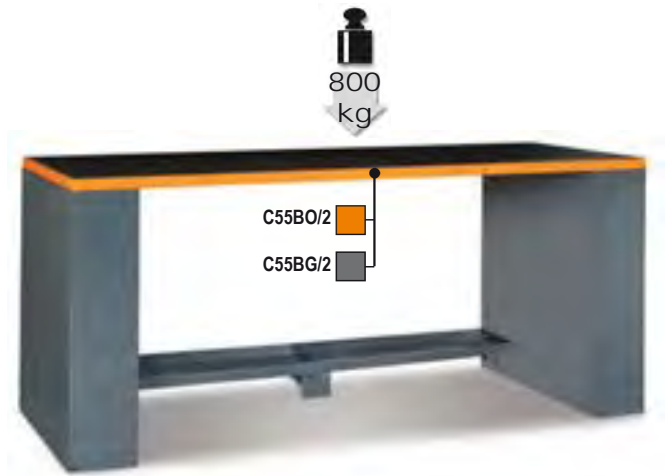

C55BO/2	€ 2.510,00	1	055000101
C55BG/2	€ 2.510,00	1	055000111

C55PRO B/2

Werkbank, 2 Meter lang, für Werkstatteinrichtung

Mit Arbeitsplatte 2050x700 mm, verkleidet mit einer stoß- und kratzfesten PVC-Schicht, kohlenwasserstoffbeständig

Integrierte Steckdosen und Aufroller:

- Schuko-Steckdose +16+10A
- EU-Steckdose Plug 10A
- Druckluftzufuhr mit Aufroller, Ø 8 mm, Schlauchlänge: 10 m.
- Bohrungen zum Einbringen eines Schraubstocks (Art. 1599F/150 - 1599GI/150, separat zu bestellen)
- Höhenverstellbare Füße

110 kg

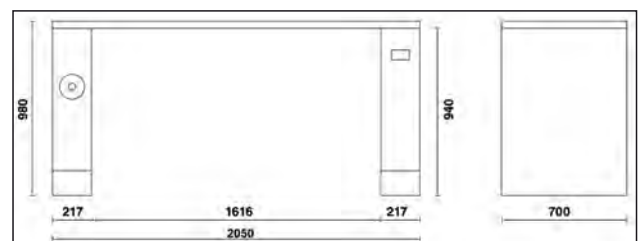
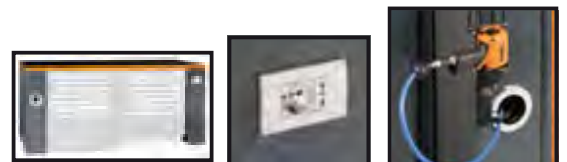
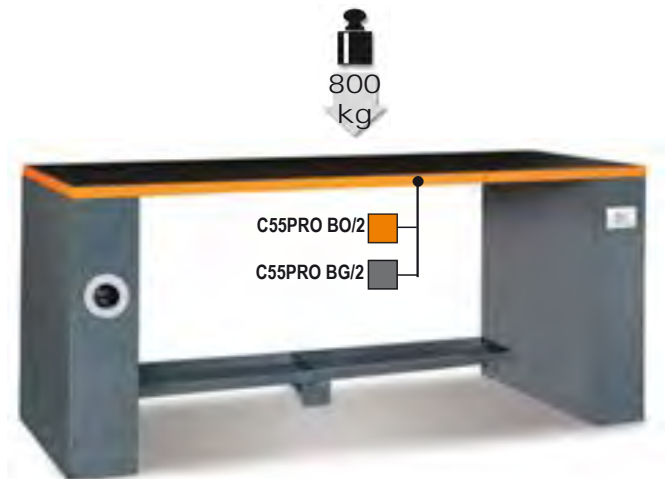

C55PRO BO/2	€ 3.080,00	1	055000151
C55PRO BG/2	€ 3.080,00	1	055000171

C55B/2,8

Werkbank 2,8 Meter lang für Werkstatteinrichtung

Mit Arbeitsfläche 2850x700 mm, verkleidet mit einer stoß- und kratzfesten PVC-Schicht, kohlenwasserstoffbeständig

- Bohrungen zum Einbringen eines Schraubstocks 1599F/150 - 1599GI/150 (separat bestellbar)
- Höhenverstellbare Füßen

129 kg

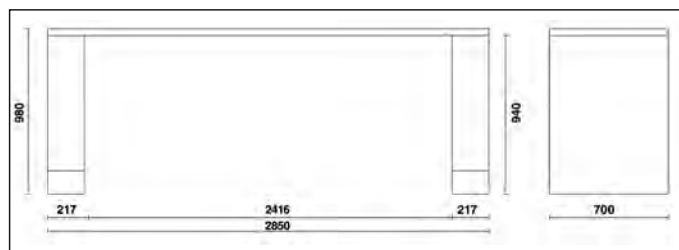
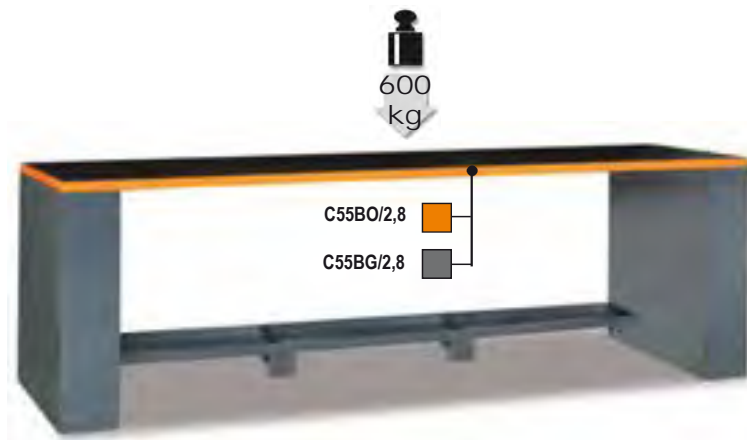

	€		
C55BO/2,8	3.150,00	1	055000261
C55BG/2,8	3.150,00	1	055000281

C55PRO B/2,8

Werkbank, 2,8 Meter lang, für Werkstatteinrichtung

Mit Arbeitsplatte 2850x700 mm, verkleidet mit einer stoß- und kratzfesten PVC-Schicht, kohlenwasserstoffbeständig

Integrierte Steckdosen und Aufroller:

- Schuko-Steckdose +16+10A
- EU-Steckdose Plug 10A
- Druckluftzufuhr mit Aufroller, Ø 8 mm, Schlauchlänge: 10 m.
- Bohrungen zum Einbringen eines Schraubstocks (Art. 1599F/150 - 1599GI/150, separat zu bestellen)
- Höhenverstellbare Füße

134 kg

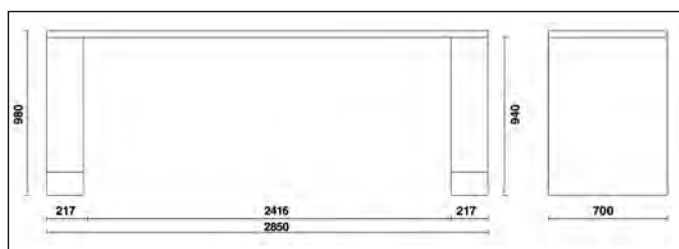
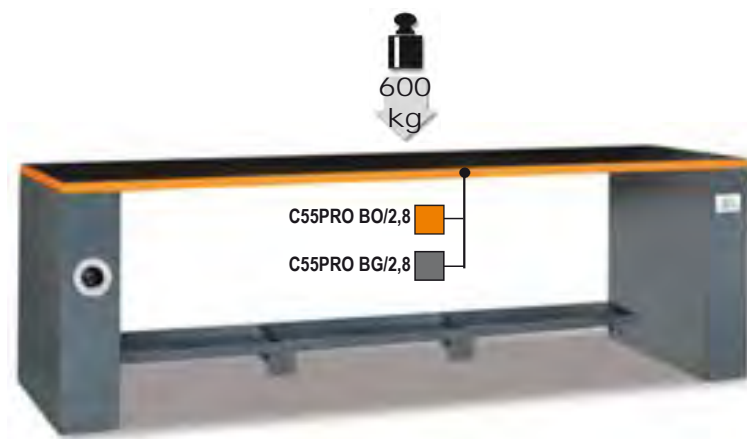

	€		
C55PRO BO/2,8	3.730,00	1	055000271
C55PRO BG/2,8	3.730,00	1	055000283

C55B-D4

Doppel-Werkbank, 4 Meter lang, mit mittlerem Stützbein

Mit Arbeitsfläche 4100x700 mm, verkleidet mit einer stoß- und kratzfesten PVC-Schicht, kohlenwasserstoffbeständig

- Bohrungen zum Einbringen eines Schraubstocks 1599F/150 - 1599GI/150 (separat bestellbar)
- Höhenverstellbare Füßen
- Mit mittlerem Doppel-Stützbein, Aufbewahrungsfach und Falltür 365x750 mm

185 kg

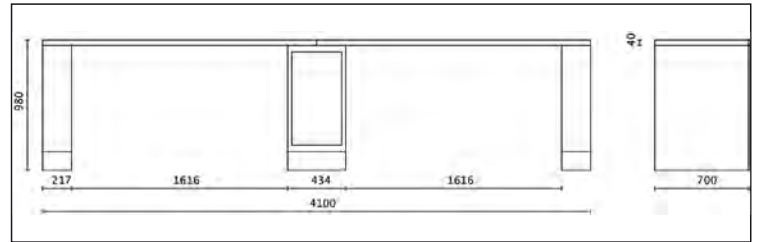
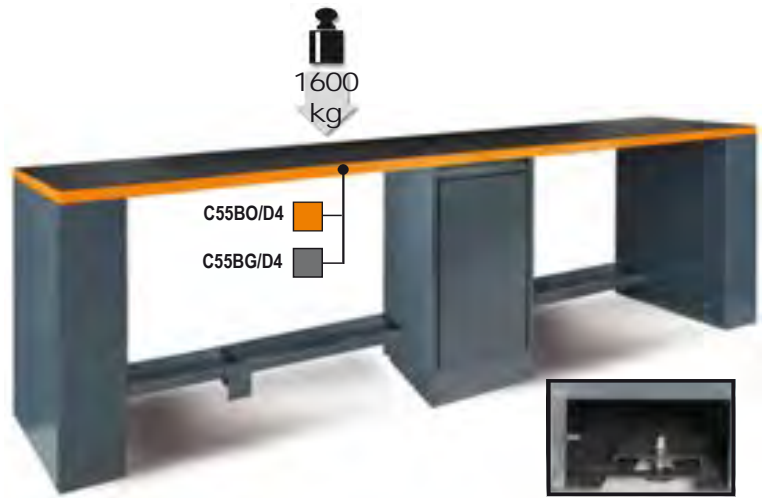

C55BO/D4	€ 5.100,00	1	055000109
C55BG/D4	€ 5.100,00	1	055000119

C55PRO B-D4

Doppel-Werkbank, 4 Meter lang, mit mittlerem Stützbein

Mit Arbeitsplatte 4100x700 mm, verkleidet mit einer stoß- und kratzfesten PVC-Schicht, kohlenwasserstoffbeständig

Integrierte Steckdosen und Aufroller:

- Schuko-Steckdose +16+10A
- EU-Steckdose Plug 10A
- Druckluftzufuhr mit Aufroller, Ø 8 mm, Kabellänge: 10 m.
- Bohrungen zum Einbringen eines Schraubstocks (Art. 1599F/150 - 1599GI/150, separat zu bestellen)
- Höhenverstellbare Füße
- Mittleres Doppel-Stützbein, Aufbewahrungsfach und Falltür, 365x750 mm

190 kg

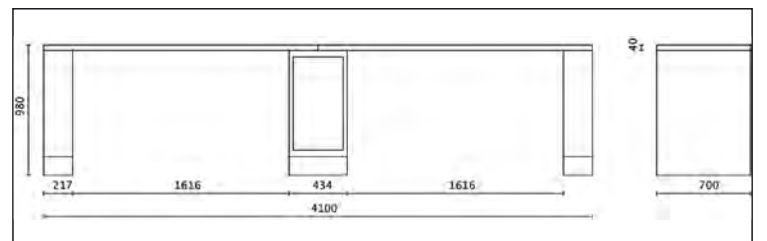
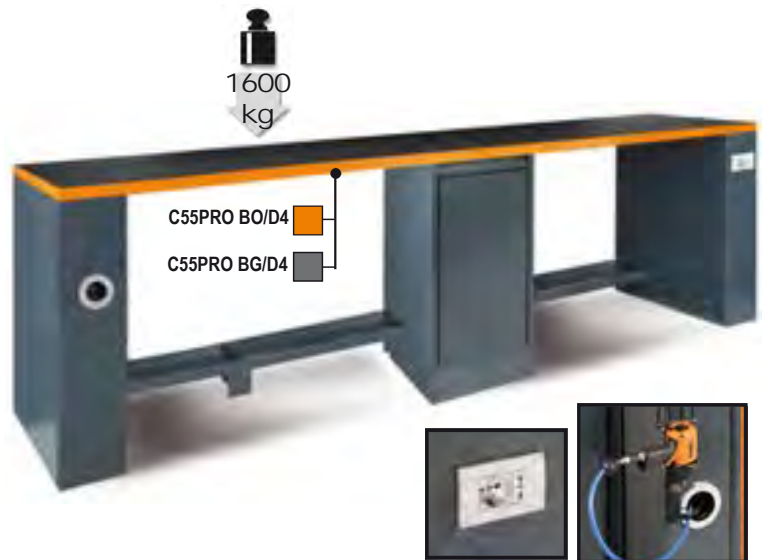

C55PRO-BO/D4	€ 5.670,00	1	055000159
C55PRO-BG/D4	€ 5.670,00	1	055000179

Beta

C55B/G

Universal-Stützbein für Werkbank Werkstatteinrichtung

- Mit höhenverstellbaren Füßen
- Verwendbar für beide Seiten der Werkbank
- Zugang frontal und seitlich

 30 kg

C55B/G € 675,00 1 055000096

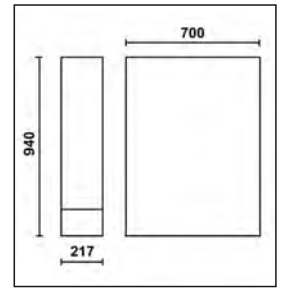

C55B/GAA

Universal-Stützbein mit integriertem Schlauchaufroller für Werkbank Werkstatteinrichtung

- Integrierter automatischer Schlauchaufroller für Druckluft oder Kaltwasser, Ø 8 mm
- Schlauchlänge: 10 m
- Mit höhenverstellbaren Füßen
- Zugang frontal und seitlich

 35 kg

C55B/GAA € 1.098,00 1 055000099

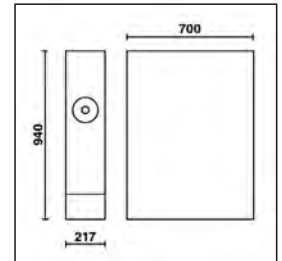

C55B/GDP

Doppel-Stützbein für aneinandergereihte Werkbänke für Werkstatteinrichtung

- Papieraufbewahrungsfach für vorgestanzte Rollen
- Aufbewahrungsfach mit Tür
- Mit höhenverstellbaren Füßen

 45 kg

C55B/GDP € 1.605,00 1 055000292

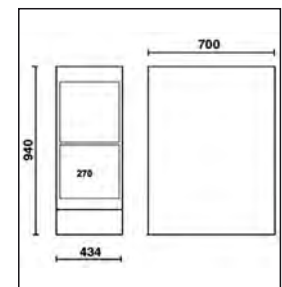

C55B/GDS

Doppel-Stützbein für aneinandergereihte Werkbänke für Werkstatteinrichtung

- Aufbewahrungsfach mit Falltür, 365x750 mm
- Mit höhenverstellbaren Füßen

 45 kg

C55B/GDS € 1.435,00 1 055000291

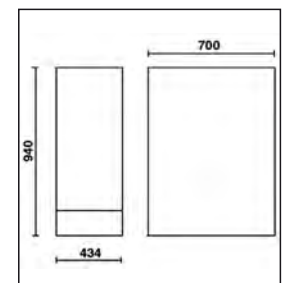

C55B/GE

Universal-Stützbein mit Steckdosen für Werkbank Werkstatteinrichtung

- Schukobuchse +16+10A
- EU-Buchse Plug +10A
- Mit höhenverstellbaren Füßen
- Zugang frontal und seitlich

30 kg

C55B/GE € 829,00 1 055000097

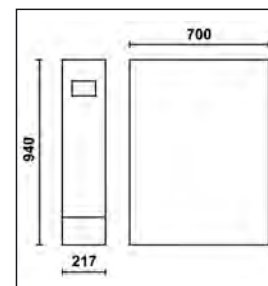

C55B/GAE

Universal-Stützbein mit integriertem Kabelaufroller für Werkbank Werkstatteinrichtung

- Integrierter Automat-Kabelaufroller mit Schuko-Steckdose.
- Kabellänge: 15 m
- Mit Thermoschutz
- Mit höhenverstellbaren Füßen
- Zugang frontal und seitlich

35 kg

C55B/GAE € 1.173,00 1 055000094

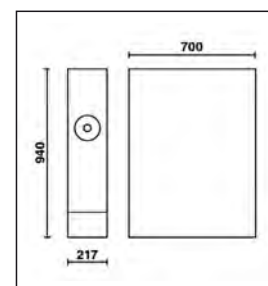
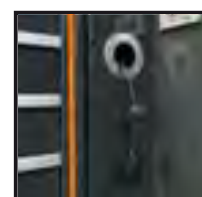

C55/PL-1,024

Arbeitsplatte, 1 Meter lang, zur Erweiterung von Werkbank
Werkstatteinrichtung

Blech-Arbeitsplatte, lackiert, 1024x700 mm, verkleidet mit einer stoß- und
kratzfesten PVC-Schicht, kohlenwasserstoffbeständig

21 kg

C55/PLO-1,024	€ 557,00	1	055000130
C55/PLG-1,024	€ 557,00	1	055000131



C55B PT/2

Arbeitsplatte, 2 Meter lang, für Werkbank Werkstatteinrichtung

Blech-Arbeitsplatte, lackiert, 2050x700 mm, verkleidet mit einer stoß- und
kratzfesten PVC-Schicht, kohlenwasserstoffbeständig

Bohrungen zum Einbringen eines Schraubstocks (Art. 1599F/150 -
1599GI/150, separat zu bestellen)

43 kg

C55BO PT/2	€ 1.157,00	1	055000106
C55BG PT/2	€ 1.157,00	1	055000116

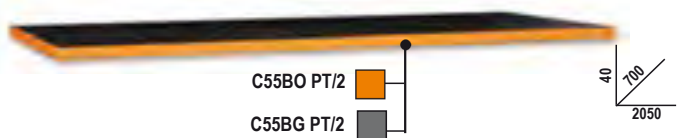

C55B PT/2,8

Arbeitsplatte, 2,8 Meter lang, für Werkstatteinrichtung

Blech-Arbeitsplatte, lackiert, 2850x700 mm, verkleidet mit einer stoß- und
kratzfesten PVC-Schicht, kohlenwasserstoffbeständig

Bohrungen zum Einbringen eines Schraubstocks (Art. 1599F/150 -
1599GI/150, separat zu bestellen)

61 kg

C55BO PT/2,8	€ 1.800,00	1	055000266
C55BG PT/2,8	€ 1.800,00	1	055000286



C55RB

Stoß- und kratzfeste PVC-Schicht, kohlenwasserstoffbeständig

zum Schutz der Arbeitsplatte.

C55RB/2: für Werkbank 2 Meter

C55RB/2,8: für Werkbank 2,8 Meter

C55RB/0,7: für Werkbank 700x700mm

C55RB/1: für Werkbank 1 Meter



C55RB/2	€ 196,00	1	055000195
C55RB/2,8	€ 266,00	1	055000196
C55RB/0,7	€ 109,00	1	055000199
C55RB/1	€ 148,00	1	055000198

C55B/VS

Unterer Stützbügel für Werkbänke

Maße 800x230x60 mm

4 kg

C55B/VS	€ 148,00	1	055000095
---------	----------	---	-----------



C55C7

Werkzeugwagen mit sieben Schubladen für Werkstatteinrichtung

- 7 Schubladen mit Teleskopführungen, kugelgelagert, 588x367 mm
- 4 Räder Ø 100 mm, 2 starre davon 1 gebremst und 2 lenkbare
- Über die gesamte Schubladenlänge positioniertes Öffnungssystem aus Aluminium
- Schubladenböden mit Schaumgummibelag
- Zentralverriegelung mit vorderem Sicherheitsschloss
- Ausgelegt zum Einfügen von Thermoformateinsätzen

79 kg

1000 kg



h	max
70 mm	30 kg
245 mm	40 kg

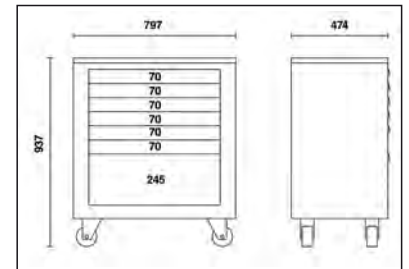
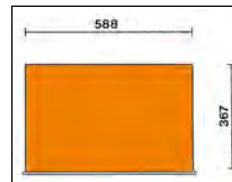

C55C7

€ 2.325,00



055000201

 **Beta**

C55C8

Modul Werkzeugwagen mit acht Schubladen für Werkstatteinrichtung

- 8 Schubladen mit Teleskopführungen, kugellagert, 588x367 mm
- 4 Räder Ø 100 mm, 2 starre davon 1 gebremst und 2 lenkbare
- Über die gesamte Schubladenlänge positioniertes Öffnungssystem aus Aluminium
- Schubladenböden mit Schaumgummibelag
- Zentralverriegelung mit vorderem Sicherheitsschloss
- Ausgelegt zum Einfügen von Thermoformateinsätzen

81 kg



h	max
70 mm	30 kg
175 mm	40 kg

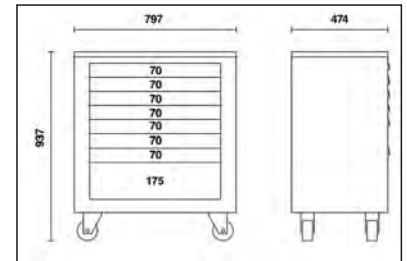
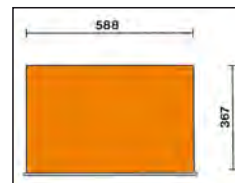
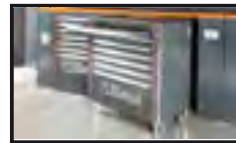

C55C8 € 2.355,00 1 055000206

C55M2

Festes Modul mit 2 Schubladen für Werkstatteinrichtung

- 2 Schubladen mit Teleskopführungen, kugellagert, 588x367mm
- Über die gesamte Schubladenlänge positioniertes Öffnungssystem aus Aluminium
- Schubladenböden mit Schaumgummibelag
- Zentralverriegelung mit vorderem Schloss

66 kg



h	max
280 mm	40 kg
385 mm	40 kg

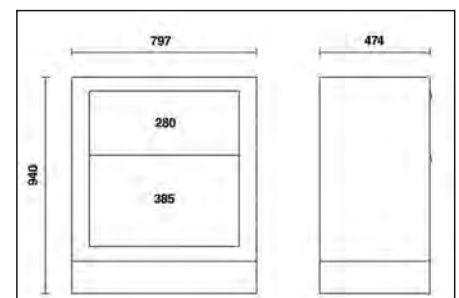
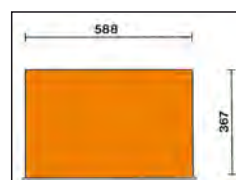

C55M2 € 1.970,00 1 055000202

C55M4

Festes Modul mit 4 Schubladen für Werkstatteinrichtung

- 4 Schubladen mit Teleskopführungen, kugelgelagert, 588x367 mm
- Über die gesamte Schubladenlänge positioniertes Öffnungssystem aus Aluminium
- Schubladenböden mit Schaumgummibelag
- Zentralverriegelung mit vorderem Schloss

75 kg

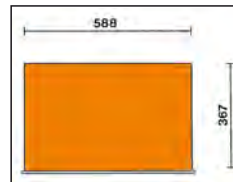
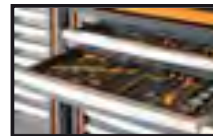

h	max
140 mm	30 kg
245 mm	40 kg

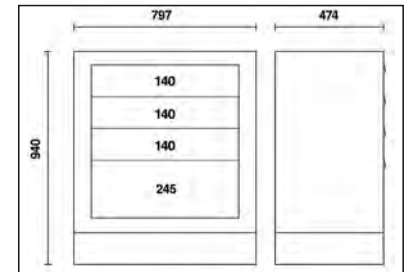

C55M4

€ 2.070,00 1 055000212

C55M7

Festes Modul mit sieben Schubladen für Werkstatteinrichtung

- 7 Schubladen mit Teleskopführungen, kugelgelagert, 588x367 mm
- Über die gesamte Schubladenlänge positioniertes Öffnungssystem aus Aluminium
- Schubladenböden mit Schaumgummibelag
- Zentralverriegelung mit vorderem Sicherheitsschloss
- Ausgelegt zum Einfügen von Thermoformateinsätzen

78 kg

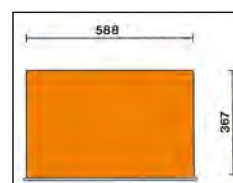

h	max
70 mm	30 kg
245 mm	40 kg

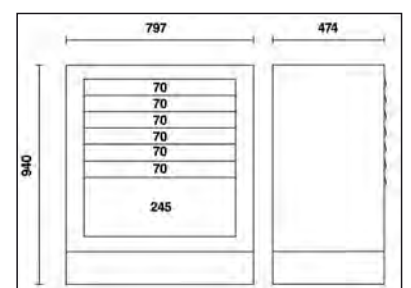

C55M7

€ 2.195,00 1 055000203

C55M8

Festes Modul mit 8 Schubladen für Werkstatteinrichtung

- 8 Schubladen mit Teleskopführungen, kugelgelagert, 588x367 mm
- Über die gesamte Schubladenlänge positioniertes Öffnungssystem aus Aluminium
- Schubladenböden mit Schaumgummibelag
- Zentralverriegelung mit vorderem Sicherheitsschloss
- Ausgelegt zum Einfügen von Thermoformateinsätzen

📦 78,9 kg

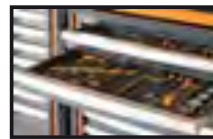

h	max
70 mm	30 kg
175 mm	40 kg

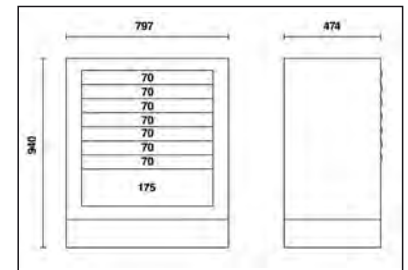
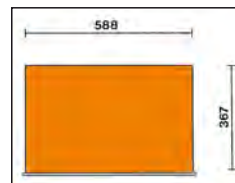

C55M8

€ 2.240,00 1 055000207

C55CS

Festes Modul für Trennmüll für Werkstatteinrichtung

- Ausziehbares Abfallfach 588x465, auf Teleskopführungen, kugelgelagert, montiert
- 2 geräumige ausziehbare Innenbehälter zur Mülltrennung

📦 62 kg

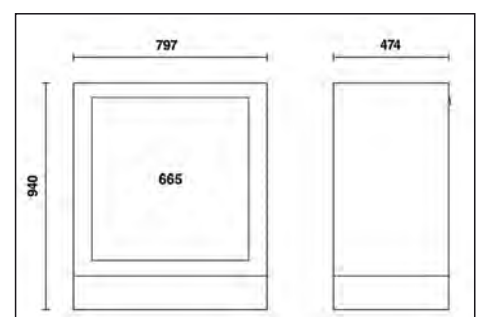

C55 CS

€ 2.000,00 1 055000208

C55MA

Festes Modul mit 2 Türen für Werkstatteinrichtung

- Öffnen durch ein Push-Pull-System
- Mit Sicherheitsschloss
- Höhenverstellbare interne Ablage

75 kg

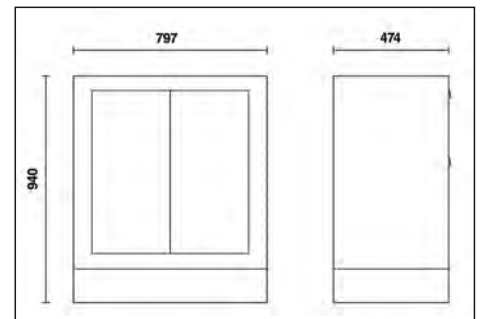

C55MA

€ 1.705,00 1 055000205

C55MDO

Festes Modul Ölausgabe für Werkstatteinrichtung

- 2 Aufrollvorrichtungen mit Schlauch, 7m - 1/2" inklusive
- Mit 2 Zapfpistolen mit digitalem Literzähler, ausgerüstet mit automatischer Tropfenauffangvorrichtung.
- Max. Durchlaufmenge: 30 l/min
- Viskosität: 8÷2000 mPas

94 kg

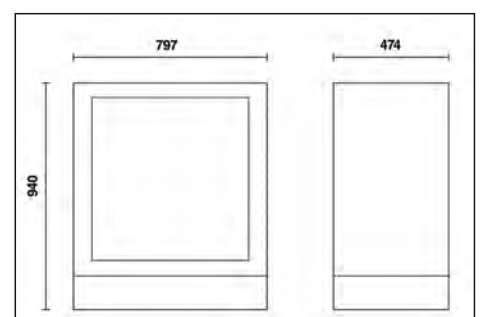

C55MDO

€ 3.580,00 1 055000210

C55MS

Festes Servicemodul für Werkstatteinrichtung

- Eingebauter Mülleimer
- Papierrollenfach, für vorgelochte Rollen
- Großes Ablagefach, 305x270 mm

75 kg

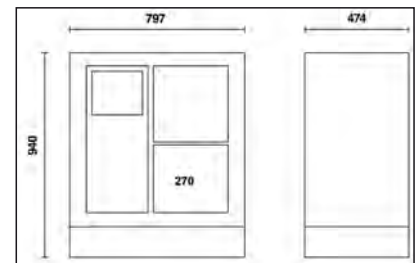

C55MS

€ 1.800,00 1 055000204

C55T3

Werkzeugwagen

- 3 mit rutschfestem Riffelgummi bedeckte Einlegeböden
- Ergonomischer Griff
- Doppelte Befestigungsmöglichkeit des mittleren Einlegebodens
- Vier Räder Ø 100 mm (zwei mit Bremse)
- Statische Belastung: 200 kg (über 3 Ebenen verteilt)

21 kg



200 kg

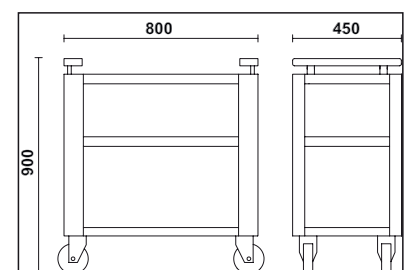

C55T3

€ 407,00 1 055000219

C55P/MCD

Doppelte zentrale Mittelträger

10 kg

C55P/MCD

€ 171,00 1 055000257



C55P/2MDX-SX

1 Paar Wandträger Rechts/Links

10 kg

C55P/2MDX-SX

€ 313,00 1 055000253



C55PM

Hängeschrank 1 Meter für Werkstatteinrichtung

• Maße: 1024x400x300 mm; mit Gasfedern zum einfachen Öffnen und Schließen der Flügeltür

24 kg

C55PM

€ 1.142,00 1 055000302

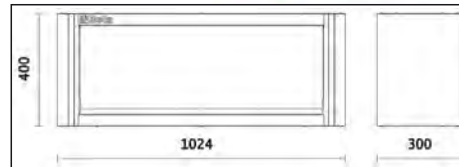

C55PFA-1,0

Selbsttragende Lochtafel 1 Meter für Werkstatteinrichtung

Stahl-Lochplatte, 1024x1020x25 mm, zur Unterbringung der Werkzeuge

11 kg

C55PFA-1,0

€ 384,00 1 055000316



C55/PF

Lochplatte unter Hängeschrank für Werkstatteinrichtung, 1 Meter lang

• Lochplatte, 1024x600 mm, zur Unterbringung der Werkzeuge, über über C55PT1,0x0,6 anzubringen

6 kg

C55/PF

€ 263,00 1 055000307



C55PT1,0X0,6

Tafel unter Hängeschränk 1 Meter

Maße 1024x620x25 mm

8 kg

C55PT1,0X0,6 € 210,00 1 055000314



C55PTE-1,0

Tafel unter Hängeschränk 1 Meter

Maße 1024x620x25 mm

Mit Vorbereitung für 2 Steckdosen (nicht inbegriffen)

8 kg

C55PTE-1,0 € 250,00 1 055000319



C55/2PM

Wand mit 2 Hängeschränken für Werkstatteinrichtung

- 2 Hängeschränke, 1024x400x300 mm, mit Gasdruckfedern zur einfacheren Öffnung und Schließung der Türen.
- Wandpaneel, 2050x620 mm, ausgelegt zur Unterbringung von Werkzeuglochplatten C55/PF (separat zu bestellen)
- Geliefert mit Trägerstruktur
- Kombinierbar mit 2 meter-langer Werkbank

80 kg

C55/2PM € 3.200,00 1 055000301

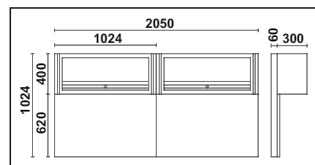

 **Beta**

C55PFA-0,8

Selbsttragende Lochtafel 0,8 Meter für Werkstatteinrichtung

Stahl-Lochplatte, 800x1020x25 mm, zur Unterbringung der Werkzeuge

10 kg

C55PFA-0,8 € 353,00 1 055000315



C55PM/M0,8

Hängeschrank 0,8 Meter für Werkstatteinrichtung

Maße: 800x400x300 mm; mit Gasfedern zum einfachen Öffnen und Schließen der Flügeltür

19 kg

C55PM/M0,8 € 1.097,00 1 055000312

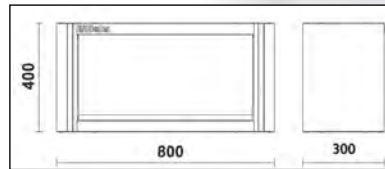

C55PTE-0,8

Tafel unter Hängeschrank 0,8 Meter

Maße 800x620x25 mm
Mit Vorbereitung für 1 Steckdose (nicht inbegriffen)

6 kg

C55PTE-0,8 € 226,00 1 055000318



C55PT0,8X0,6

Tafel unter Hängeschrank 0,8 Meter

Maße 800x620x25 mm

7,8 kg

C55PT0,8X0,6 € 196,00 1 055000313



C55/1PF

Werkzeuglochplatte für Werkstatteinrichtung

• Lochplatte 800x600 mm für Werkzeuge

5 kg

C55/1PF € 176,00 1 055000309



C55PS

Werkzeugwand mit Rollladen für Werkstatteinrichtung

- Aluminiumrollladen, vertikal manövrierbar, mit Sicherheitsschloss
- Abnehmbare Lochtafel zur Unterbringung der Werkzeuge
- Geliefert mit Trägerstruktur
- Satz 50 GPS-Haken inbegriffen
- Kombinierbar mit Werkbank 2 Meter lang

88 kg

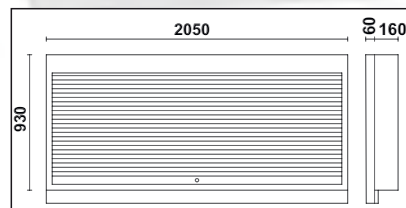

C55PS-O	€ 2.260,00	1	055000250
C55PS-G	€ 2.260,00	1	055000255

C55PSE

Werkzeugwagen mit Rollladen und Vorbereitung für 2 Steckdosen

- Aluminiumrollladen, vertikal manövrierbar, mit Sicherheitsschloss
- Abnehmbare Lochtafel zur Unterbringung der Werkzeuge
- Geliefert mit Trägerstruktur
- Satz 50 GPS-Haken inbegriffen
- Vorbereitet für Steckdosen (nicht inbegriffen)
- Kombinierbar mit Werkbank 2 Meter

88 kg

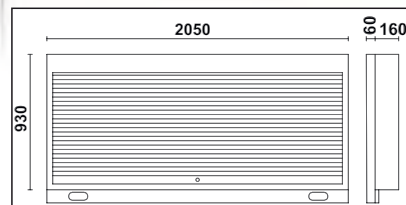
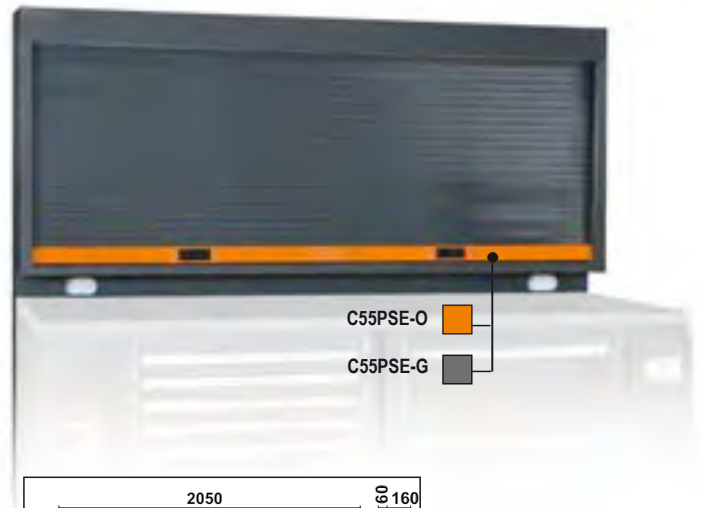

C55PSE-O	€ 2.290,00	1	055000258
C55PSE-G	€ 2.290,00	1	055000260

C55AE

Profil 2 Meter mit elektrischer Vorbereitung

Maße 2050x25x90mm
Mit Vorbereitung für 2 Steckdosen

1,5 kg



C55AE	€ 210,00	1	055000325
-------	----------	---	-----------

C55AC

Komplettecke, selbsttragend

Arbeitsfläche 700x700 mm mit Stützbeinen
2 obere Werkzeugwände mit 2 Regalen für Befestigung 670x160 mm

66 kg

C55AC-O	€ 2.610,00	1	055000360
C55AC-G	€ 2.610,00	1	055000380

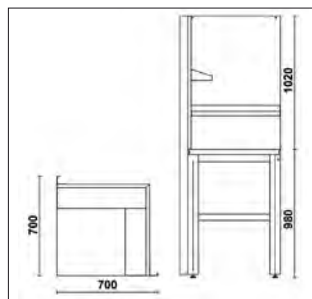

C55AC-O

C55AC-G



C55KAI

Eckelement 700x700 mm mit Stützbeinen

• Blech-Arbeitsfläche, lackiert, 700x700 mm, verkleidet mit einer stoß- und kratzfesten PVC-Schicht, kohlenwasserbeständig

32 kg

C55KAI-O	€ 1.505,00	1	055000365
C55KAI-G	€ 1.505,00	1	055000385

C55KAI-O

C55KAI-G

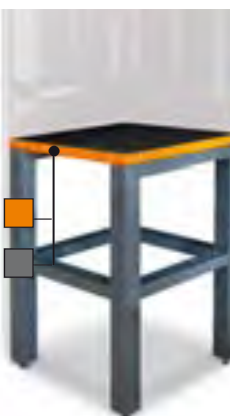

C55KAS

Oberer Ecke mit Werkzeugwänden

• 2 Lochwände 700x1020x25 mm
• 2 Regale für Befestigung 670x160 mm

24 kg

C55KAS	€ 1.110,00	1	055000370
--------	------------	---	-----------



C55MP

Stahlregale für Eckwände

Abmessungen 700x160x80 mm

C55MP	€ 156,00	1	055000374
-------	----------	---	-----------

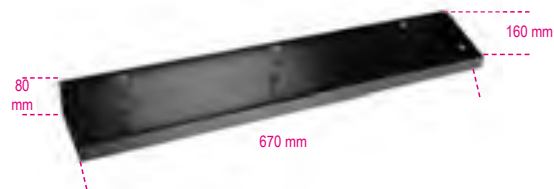

C55B/1

Erweiterung, 1 Meter

Arbeitsfläche 1024x700 mm, verkleidet mit einer stoß- und kratzfesten PVC-Schicht, kohlenwasserstoffbeständig

- Universal-Stützbein mit höhenverstellbaren Füßen

1 festes Modul:

- 7 Schubladen mit Teleskopführungen, kugelgelagert, 588x367 mm
- Über die gesamte Schubladenlänge positioniertes Öffnungssystem aus Aluminium
- Schubladenböden mit Schaumgummibelag
- Zentralverriegelung mit vorderem Sicherheitsschloss

127 kg



C55BO/1
C55BG/1



h	max
70 mm	30 kg
245 mm	40 kg

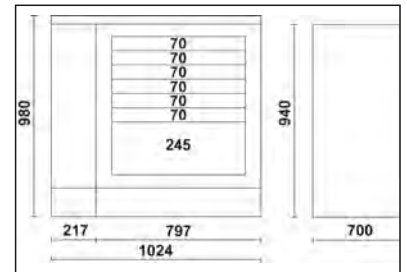
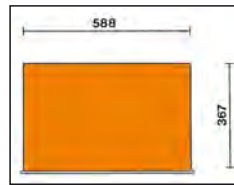

Code	Price (€)	Quantity	Part Number
C55BO/1	3.430,00	1	055000090
C55BG/1	3.430,00	1	055000091



C55A1

Blechschränk, 1-türig, für Werkstatteinrichtung

- 3 abnehmbare höhenverstellbare Ablagen
- Praktische klappbare Kleiderstange unter dem ersten Fachboden
- Mit Schloss
- Nutzbares Innenmaß: 1770x420x420 mm

📦 50 kg

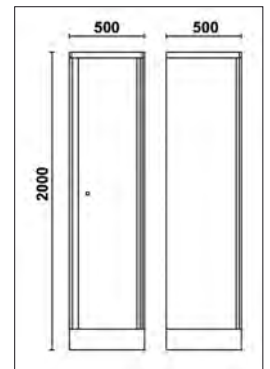

C55A1 € 829,00 1 055000411

C55A1/R42

Innenablage für Schrank Art. C55A1/C55AT1

📦 2,4 kg



C55A1/R42 497x403 mm € 36,00 1 055000461

C55 A1/RB42

Innerer Einlegeboden für Schrank C55A1/C55AT1 mit Kleiderstange

📦 2,5 kg



C55 A1/RB42 497x403 mm € 84,50 1 055000463

Beta

C55A2

2-türiger Blechschrank für Werkstatteinrichtung

- 3 abnehmbare höhenverstellbare Ablagen
- Mit Verschluss
- Nutzbares Innenmaß: 1798x797x403 mm

72 kg

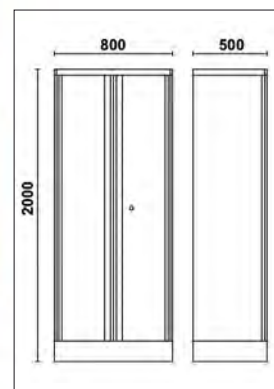

C55A2

€ 1.112,00



1



055000412

C55A2/R70

Innenablage für Schrank Art. C55A2/C55AT2

3,5 kg



C55A2/R70

700x420 mm

€ 58,00



1



055000462



 **Beta**

C55AT1

Blechschränk mit transparenter Tür aus Polycarbonat für Werkstatteinrichtung

- 3 abnehmbare höhenverstellbare Ablagen
- Mit Verschluss
- Nutzbares Innenmaß: 1798x497x403 mm

41 kg

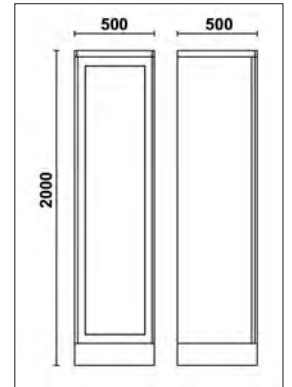

C55AT1

€ 999,00 1 055000421

C55AT2

Blechschränk mit 2 transparenten Türen aus Polycarbonat für Werkstatteinrichtung

- 3 abnehmbare höhenverstellbare Ablagen
- Mit Verschluss
- Nutzbares Innenmaß: 1798x797x403 mm

56 kg

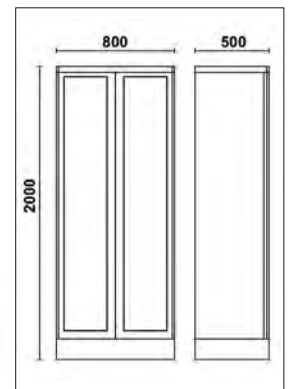

C55AT2

€ 1.340,00 1 055000422

C55STR

Farbiges Klebeband, 25 m

Ermöglicht, die senkrechten Einsätze der Werkstatteinrichtung Art. C55 mit Farbe individuell zu gestalten



RAL2011
RAL3000
RAL6029
RAL9016
RAL1023
RAL5015
RAL1035
RAL9006

	€	1	055000901
C55STR-O/2011	84,50	1	055000901
C55STR-R/3000	84,50	1	055000903
C55STR-V/6029	84,50	1	055000906
C55STR-W/9016	84,50	1	055000907
C55STR-Y/1023	84,50	1	055000905
C55STR-B/5015	84,50	1	055000904
C55STR-GO/1035	84,50	1	055000909
C55STR-S/9006	84,50	1	055000902





WERKSTATTEINRICHTUNG



Made in Italy
Beta präsentiert die neue

Werkstatteinrichtung und ist stolz Ihnen die neue Einrichtungsline präsentieren zu können.

Durch die Erfahrungen mit der RSC55 und der C45PRO, wissen wir, was unsere Kunden brauchen. Deshalb basiert das Design der Linie RSC50 auf folgenden Kernfaktoren:

Qualität

Die sorgfältige Auswahl der verwendeten Materialien, die akribische Aufmerksamkeit fürs Detail und nicht zuletzt das attraktive Design machen die Linie RSC50 einzigartig.

Flexibilität

Jede Einrichtungskombination kann jederzeit erweitert oder verändert werden, um sie den jeweiligen Bedürfnissen anzupassen.



Kompatibilität

Dank der Standardgröße Beta (588 x 367 mm) können die Schubladen die zahlreichen Werkzeugmodule in den Ausführungen EVA weich oder ABS hart aufnehmen.

Zweckmässigkeit

Schnell und einfach zu montieren, dank der optimierten Produktion der verschiedenen Bauteile der Linie.



Funktionalität und Strapazierfähigkeit

Die 63 cm tiefe Arbeitsplatte bietet eine große, praktische und funktionelle Arbeitsfläche. Die Vorrichtung für einen Schraubstock macht sie auch für schwere Aufgaben geeignet.



MADE IN ITALY



Konfigurieren Sie Ihre Werkstatt online in 3D auf www.beta-tools.com/rsc50

Die neue RSC50 bietet für Profis vormontierte Kombinationen. Alternativ kann aus einer Vielzahl von Untertischmodulen, Aufbauten und Accessoires ausgewählt und ein individueller Arbeitsplatz gestaltet werden.

Die individuell farblich wählbaren Schubladengriffen und die Möglichkeit zur Anbringung einer Beleuchtung unter Arbeitsplatten und Oberschränken macht die RSC50 zur perfekten Wahl für diejenigen, die in einer funktionalen und praktischen Umgebung arbeiten möchten.



RSC50 I

Werkstatteinrichtung Kombination RSC50

Kombination bestehend aus:

- 1 Arbeitsplatte mit einer Länge von 2.240 mm (RSC50 PG/3-2,2MT)
- 1 Arbeitsplatte mit einer Länge von 1.495 mm (RSC50 PG/2-1,5MT)
- 1 festes Modul mit 7 Schubladen (RSC50 M7)
- 1 mobile Rollenkabine mit 7 Schubladen (RSC50 C7)
- 1 festes Servicemodul mit 2 Schubladen (RSC50 MS-2C)
- 1 selbsttragende Komplettecke (RSC50 AC-G)
- 1 festes Modul mit 5 Schubladen (RSC50 M5)
- 1 festes zweitüriges Modul (RSC50 MA)
- 5 wandmontierte Schränke (RSC50 PM)
- 5 obere gelochte Werkzeugtafeln (RSC50 PFS)
- 5 untere gelochte Werkzeugtafeln (RSC50 PFI)
- 5 Paare von rechten/linken Ständern (RSC50 P/2MDX-SX)
- 2 eintürige Schränke (RSC50 A1)

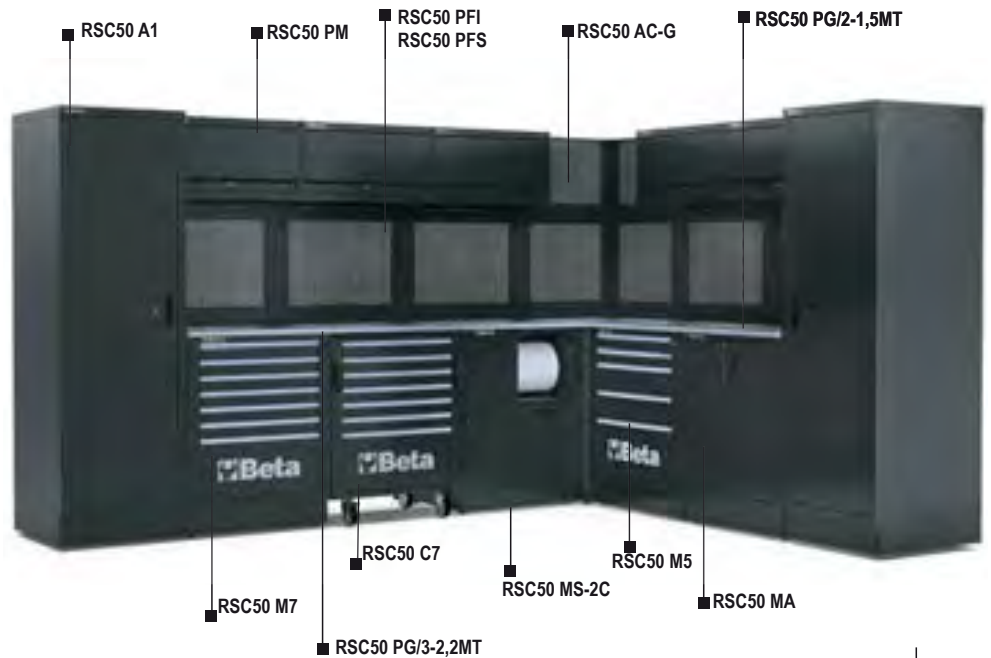

625 kg

RSC50 I € 21.010,00 1 050001045

RSC50 L

Werkstatteinrichtung Kombination RSC50

Kombination bestehend aus:

- 1 Arbeitsplatte mit einer Länge von 2.240 mm (RSC50 PG/3-2,2MT)
- 1 750 mm lange Arbeitsplatte (RSC50 PG/1-0,7MT)
- 1 feststehendes Servicemodul (RSC50 MS-2AVV) mit Druckluft-Schlauchtrommel Artikel 1900S 8x10 und Kabeltrommel Artikel 1844 15-H05/SCK (inklusive)
- 1 mobile Rollenkabine mit 7 Schubladen (RSC50 C7)
- 1 festes Modul mit 7 Schubladen (RSC50 M7)
- 1 selbsttragende Komplettecke (RSC50 AC-G)
- 1 feststehendes zweitüriges Modul (RSC50 MA)
- 1 Werkzeugwandssystem mit Aluminiumblende und Rahmen (RSC50 PS)
- 2 wandmontierte Schränke (RSC50 PM)
- 2 obere gelochte Werkzeugtafeln (RSC50 PFS)
- 2 untere gelochte Werkzeugtafeln (RSC50 PFI)
- 2 Paare von rechten/linken Ständern (RSC50 P/2MDX-SX)
- 2 eintürige Werkzeugschränke (RSC50 A1)

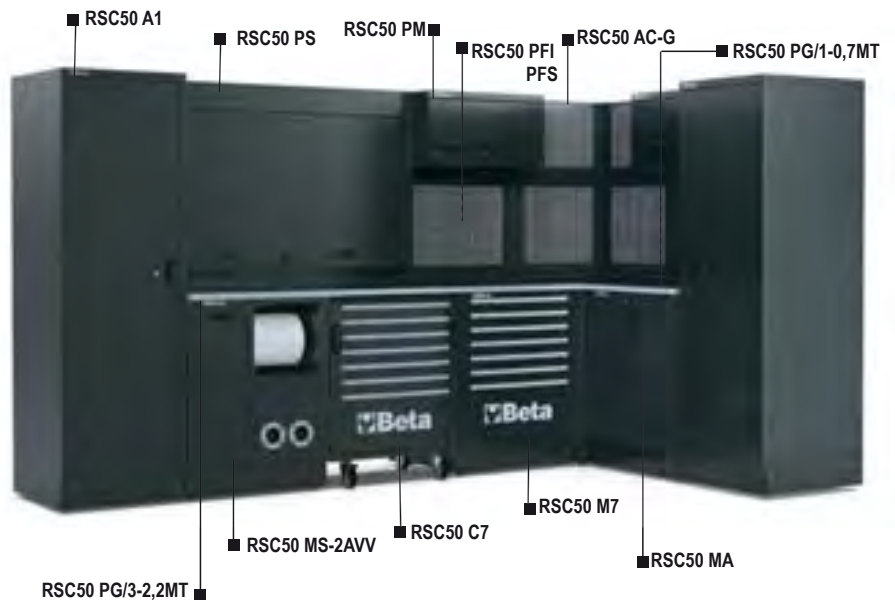

541 kg

RSC50 L € 18.360,00 1 050001050

RSC50

Umfangreiche Werkstattausrüstungskombination RSC50

Umfassende Kombination bestehend aus:

- 1 eintüriger Werkzeugschrank (RSC50 A1)
- 1 Arbeitsplatte mit einer Länge von 750 mm (RSC50 PG/1-0,7MT)
- 1 Arbeitsplatte mit einer Länge von 2.240 mm (RSC50 PG/3-2,2MT)
- 1 mobile Rollenkabine mit 7 Schubladen (RSC50 C7)
- 1 festes Modul mit 4 Schubladen (RSC50 M4)
- 1 festes Modul mit 7 Schubladen (RSC50 M7)
- 1 festes Servicemodul (RSC50 MS-AVV) mit Druckluftschlauchaufroller Artikel 1900S 8x10 (im Lieferumfang enthalten)
- 1 Werkzeugwandssystem mit Aluminiumblende und Rahmen (RSC50 PS)
- 2 wandmontierte Schränke (RSC50 PM)
- 2 obere gelochte Werkzeugtafeln (RSC50 PFS)
- 2 untere gelochte Werkzeugtafeln (RSC50 PFI)
- 2 Paar rechte/linke Ständer (RSC50 P/2MDX-SX)
- 1 zweitüriger Werkzeugschrank (RSC50 A2)



534 kg

RSC50

16.680,00



1



050001000

RSC50 H

Werkstatteinrichtung Kombination RSC50

Kombination bestehend aus:

- 1 Arbeitsplatte mit einer Länge von 2.240 mm (RSC50 PG/3-2,2MT)
- 1 feststehendes Servicemodul mit 2 Schubladen (RSC50 MS-2C)
- 1 mobile Rollenkabine mit 7 Schubladen (RSC50 C7)
- 1 festes Modul mit 7 Schubfächern (RSC50 M7)
- 1 festes Modul mit eingebautem Spülbecken (RSC50 ML)
- 4 wandmontierte Schränke (RSC50 PM)
- 4 obere gelochte Werkzeugtafeln (RSC50 PFS)
- 4 untere gelochte Werkzeugtafeln (RSC50 PFI)
- 4 Paare von rechten/linken Ständern (RSC50 P/2MDX-SX)
- 1 eintüriger Werkzeugschrank (RSC50 A1)

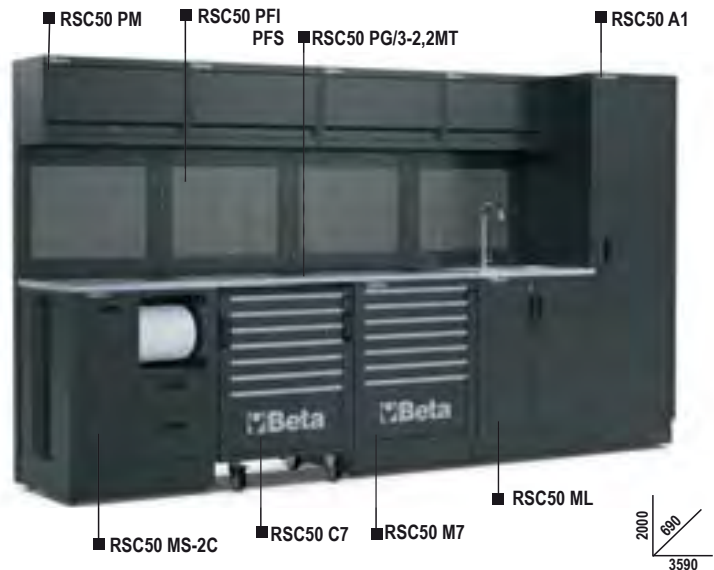

417 kg

RSC50 H

14.550,00



1



050001040

RSC50 G

Werkstatteinrichtung Kombination RSC50

Kombination bestehend aus:

- 1 Arbeitsplatte mit einer Länge von 2.240 mm (RSC50 PG/3-2,2MT)
- 1 feststehendes Servicemodul (RSC50 MS-2AVV) mit Druckluftschlauchaufroller Artikel 1900S 8x10 und Kabelaufroller Artikel 1844 15-H05/SCK (im Lieferumfang enthalten)
- 1 mobile Rollenkabine mit 7 Schubladen (RSC50 C7)
- 1 festes Modul mit 4 Schubladen (RSC50 M4)
- 3 wandmontierte Schränke (RSC50 PM)
- 3 obere gelochte Werkzeugtafeln (RSC50 PFS)
- 3 untere gelochte Werkzeugtafeln (RSC50 PFI)
- 3 Paare von rechten/linken Ständern (RSC50 P/2MDX-SX)
- 1 zweitüriger Werkzeugschrank (RSC50 A2)



356 kg

RSC50 G

12.260,00



1



050001035

RSC50 F

Werkstatteinrichtung Kombination RSC50

Kombination bestehend aus:

- 1 Arbeitsplatte mit einer Länge von 2.240 mm (RSC50 PG/3-2,2MT)
- 1 feststehendes Modul mit 7 Schubladen (RSC50 M7)
- 1 mobile Rollenkabine mit 7 Schubladen (RSC50 C7)
- 1 festes Servicemodul mit 2 Schubladen (RSC50 MS-2C)
- 3 wandmontierte Schränke (RSC50 PM)
- 3 obere gelochte Werkzeugtafeln (RSC50 PFS)
- 3 untere gelochte Werkzeugtafeln (RSC50 PFI)
- 3 Paare von rechten/linken Ständern (RSC50 P/2MDX-SX)
- 1 zweitüriger Werkzeugschrank (RSC50 A2)

361 kg

RSC50 F

12.020,00



1



050001030



RSC50 E

Werkstatteinrichtung Kombination RSC50

Kombination bestehend aus:

- 1 Arbeitsplatte mit einer Länge von 2.240 mm (RSC50 PG/3-2,2MT)
- 1 feststehendes Servicemodul mit 2 Schubladen (RSC50 MS-2C)
- 1 feststehendes Modul mit 7 Schubladen (RSC50 M7)
- 1 feststehendes zweitüriges Modul (RSC50 MA)
- 3 wandmontierte Schränke (RSC50 PM)
- 3 obere gelochte Werkzeugtafeln (RSC50 PFS)
- 3 untere gelochte Werkzeugtafeln (RSC50 PFI)
- 3 Paare von rechten/linken Ständern (RSC50 P/2MDX-SX)

266 kg

RSC50 E

9.830,00



1



050001025



RSC50 D

Werkstatteinrichtung Kombination RSC50

Kombination bestehend aus:

- 1 Arbeitsplatte mit einer Länge von 1.495 mm (RSC50 PG/2-1,5MT)
- 1 feststehendes Modul mit 5 Schubladen (RSC50 M5)
- 1 feststehendes zweitüriges Modul (RSC50 MA)
- 2 wandmontierte Schränke (RSC50 PM)
- 2 obere gelochte Werkzeugtafeln (RSC50 PFS)
- 2 untere gelochte Werkzeugtafeln (RSC50 PFI)
- 2 Paar rechte/linke Ständer (RSC50 P/2MDX-SX)
- 1 eintüriger Werkzeugschrank (RSC50 A1)

230 kg

RSC50 D

7.530,00



1



050001020



RSC50 C

Werkstattausrüstung RSC50

Kombination bestehend aus:

- 1 Arbeitsplatte mit einer Länge von 1.495 mm (RSC50 PG/2-1,5MT)
- 1 feststehendes Servicemodul mit 2 Schubladen (RSC50 MS-2C)
- 1 feststehendes Modul mit 7 Schubladen (RSC50 M7)
- 2 wandmontierte Schränke (RSC50 PM)
- 2 obere gelochte Werkzeugtafeln (RSC50 PFS)
- 2 untere gelochte Werkzeugtafeln (RSC50 PFI)
- 2 Paar rechte/linke Ständer (RSC50 P/2MDX-SX)
- 1 eintüriger Werkzeugschrank (RSC50 A1)

258 kg

RSC50 C

€ 7.930,00 1 050001015

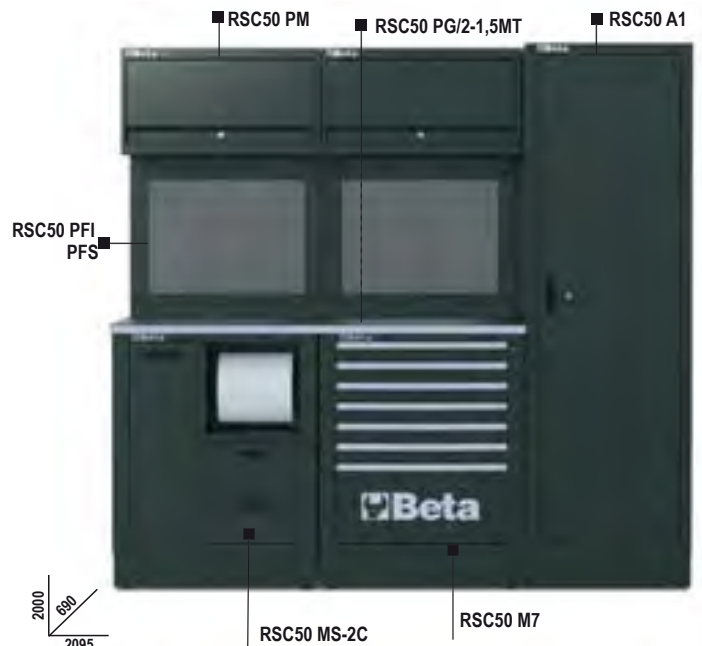

RSC50 B

Werkstatteinrichtung Kombination RSC50

Kombination bestehend aus:

- 1 Arbeitsplatte mit einer Länge von 1.495 mm (RSC50 PG/2-1,5MT)
- 1 feststehendes zweitüriges Modul (RSC50 MA)
- 1 feststehendes Modul mit 7 Schubladen (RSC50 M7)
- 1 Werkzeugwandsystem mit Aluminiumblende und Rahmen (RSC50 PS)

188 kg

RSC50 B

€ 6.860,00 1 050001010



RSC50 A

Werkstattausrüstungskombination RSC50

Kombination bestehend aus:

- 1 Arbeitsplatte mit einer Länge von 1.495 mm (RSC50 PG/2-1,5MT)
- 1 feststehendes Modul mit 7 Schubladen (RSC50 M7)
- 1 feststehendes Servicemodul mit 2 Schubladen (RSC50 MS-2C)
- 2 wandmontierte Schränke (RSC50 PM)
- 2 obere gelochte Werkzeugtafeln (RSC50 PFS)
- 2 untere gelochte Werkzeugtafeln (RSC50 PFI)
- 2 Paar rechte/linke Ständer (RSC50 P/2MDX-SX)

192 kg

RSC50 A

€ 6.950,00 1 050001005



RSC50 P/1-0,7MT

0,75 m lange Arbeitsplatte, für Werkstattgerätekombination RSC50

Arbeitsplatte aus lackiertem Blech, 750x630 mm, mit stoßfester, kratzfester und kohlenwasserstoffbeständiger PVC-Beschichtung.
Lieferung komplett mit zwei seitlichen Außenauflagen.

Bohrungen für einen Schraubstock (1599P/125, separat zu bestellen) auf beiden Seiten. Vorgesehen für die Anbringung von Aluminiumprofilen mit LED-Streifen Artikel 5000 RSC50/PLED oder 5000 RSC50/PLED-ST (separat zu bestellen), um Untertischmodule zu beleuchten.

12,4 kg

RSC50 PG/1-0,7MT	€ 568,00	1	050001107
RSC50 PA/1-0,7MT	€ 568,00	1	050001108



RSC50 PG/1-0,7MT



RSC50 PA/1-0,7MT

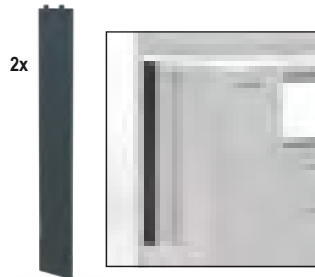

RSC50 P/2-1,5MT

1,5 m lange Arbeitsplatte, für Werkstattgerätekombination RSC50

Arbeitsplatte aus lackiertem Blech, 1.495x630 mm, beschichtet mit einer stoßfesten, kratzfesten und kohlenwasserstoffbeständigen PVC-Beschichtung.
Lieferung komplett mit zwei seitlichen Außenauflagen.

Bohrungen für einen Schraubstock (1599P/125, separat zu bestellen) auf beiden Seiten. Vorgesehen für die Anbringung von Aluminiumprofilen mit LED-Streifen Artikel 5000 RSC50/PLED oder 5000 RSC50/PLED-ST (separat zu bestellen), um Untertischmodule zu beleuchten.

24,5 kg

RSC50 PG/2-1,4MT	€ 796,00	1	050001114
RSC50 PA/2-1,4MT	€ 796,00	1	050001115



RSC50 PG/2-1,5MT



RSC50 PA/2-1,5MT

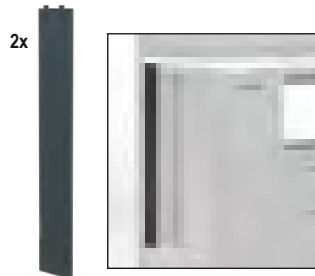

RSC50 P/3-2,2MT

2,2 m lange Arbeitsplatte, für Werkstattgerätekombination RSC50

Arbeitsplatte aus lackiertem Blech, 2.240x630 mm, mit stoßfester, kratzfester und kohlenwasserstoffbeständiger PVC-Beschichtung.
Lieferung komplett mit zwei seitlichen Außenauflagen.

Bohrungen für einen Schraubstock (1599P/125, separat zu bestellen) auf beiden Seiten. Vorgesehen für die Anbringung von Aluminiumprofilen mit LED-Streifen Artikel 5000 RSC50/PLED oder 5000 RSC50/PLED-ST (separat zu bestellen), um Untertischmodule zu beleuchten.

36,5 kg

RSC50 PG/3-2,2MT	€ 968,00	1	050001122
RSC50 PA/3-2,2MT	€ 968,00	1	050001123



RSC50 PG/3-2,2MT



RSC50 PA/3-2,2MT

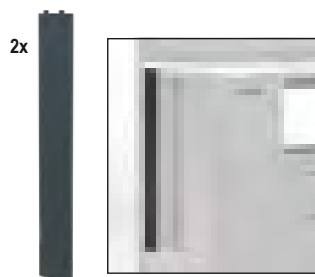

RSC50 RB

stoßfester, kratzfester PVC-Mantel, beständig gegen Kohlenwasserstoffe

Ein Muss für den Schutz von Arbeitsplatten.

RSC50 RB/0,63: für Eckarbeitsplatte, 630x630 mm

RSC50 RB/0,75: für 750 mm lange Arbeitsplatte

RSC50 RB/1,5: für 1.495 mm lange Arbeitsplatte

RSC50 RB/2,2: für 2.240 mm lange Arbeitsplatte



	€		
RSC50 RB/0,63	61,50	1	050001140
RSC50 RB/0,75	73,50	1	050001141
RSC50 RB/1,5	148,00	1	050001142
RSC50 RB/2,2	222,00	1	050001143

RSC50 C5

mobile Rollenkabine mit 5 Schubladen, für Werkstattausrüstungskombination RSC50

- 5 Schubladen (588x367 mm) mit kugelgelagerten Führungen
- 4 Lenkrollen, Ø 100 mm (2 mit Feststellern)
- Schubladenböden durch Moosgummimatten geschützt
- Zentraler Verschluss an der Vorderseite
- In den Rahmen integrierte Griffe für eine bessere Handhabung
- Jede Schublade kann bis zu 4 tiefgezogene Schalen aus EVA-Schaum oder ABS aufnehmen

51,4 kg

h	max
	25 kg
	30 kg
	35 kg

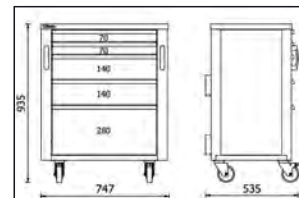
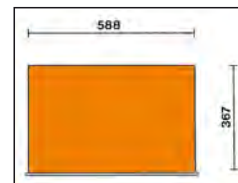

800 kg



	€		
RSC50 C5	2.020,00	1	050001205

RSC50 C7

mobile Rollenkabine mit 7 Schubladen, für Werkstattausrüstungskombination RSC50

- 7 Schubladen (588x367 mm) mit kugelgelagerten Führungen
- 4 Lenkrollen, Ø 100 mm (2 mit Feststellern)
- Schubladenböden durch Moosgummimatten geschützt
- Zentraler Verschluss an der Vorderseite
- In den Rahmen integrierte Griffe für eine bessere Handhabung
- Jede Schublade kann bis zu 4 tiefgezogene Schalen aus EVA-Schaum oder ABS aufnehmen

56,3 kg

h	max
	25 kg
	35 kg

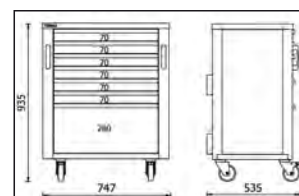
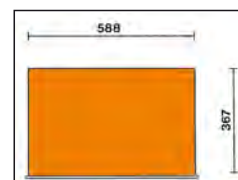

800 kg



	€		
RSC50 C7	2.110,00	1	050001207

RSC50 C8

mobile Rollenkabine mit 8 Schubladen, für Werkstattausrüstungskombination RSC50

- 8 Schubladen (588x367 mm) mit kugelgelagerten Führungen
- 4 Lenkrollen, Ø 100 mm (2 mit Feststellern)
- Schubladenböden durch Moosgummimatten geschützt
- Zentraler Verschluss an der Vorderseite
- In den Rahmen integrierte Griffe für eine bessere Handhabung
- Jede Schublade kann bis zu 4 tiefgezogene Schalen aus EVA-Schaum oder ABS aufnehmen

59 kg

h	max
70 mm	25 kg
140 mm	30 kg

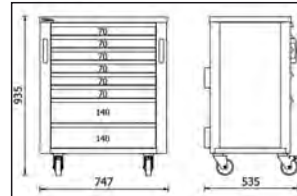
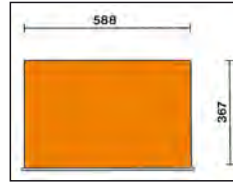

800 kg



RSC50 C8

€ 2.155,00 1 050001208

RSC50 M4

Festes Modul mit 4 Schubladen, für Werkstattausrüstungskombination RSC50

- 4 Schubladen (588x367 mm) mit kugelgelagerten Führungen
- Schubladenböden durch Moosgummimatten geschützt
- Zentralverriegelung vorne
- Mit höhenverstellbaren Füßen
- Jede Schublade kann bis zu 4 tiefgezogene Schalen aus EVA-Schaum oder ABS aufnehmen

44,5 kg

h	max
140 mm	30 kg
280 mm	35 kg

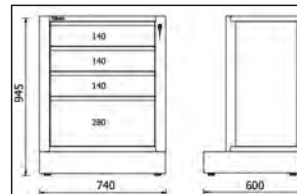
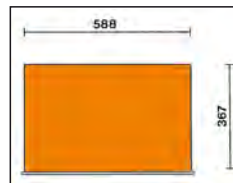

RSC50 M4

€ 1.715,00 1 050001224

RSC50 M5

Festes Modul mit 5 Schubladen, für Werkstattausrüstungskombination RSC50

- 5 Schubladen (588x367 mm) mit kugelgelagerten Führungen
- Schubladenböden durch Moosgummimatten geschützt
- Zentralverriegelung vorne
- Mit höhenverstellbaren Füßen
- Jede Schublade kann bis zu 4 tiefgezogene Schalen aus EVA-Schaum oder ABS aufnehmen

47 kg

h	max
70 mm	25 kg
140 mm	30 kg
280 mm	35 kg

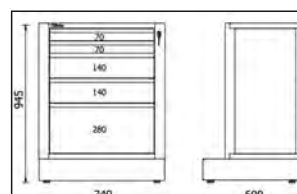
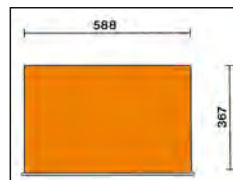



RSC50 M5

€ 1.760,00 1 050001225

RSC50 M7

Festes Modul mit 7 Schubladen, für Werkstattausrüstungskombination RSC50

- 7 Schubladen (588x367 mm) mit kugelgelagerten Führungen
- Schubladenböden durch Moosgummimatten geschützt
- Zentralverriegelung vorne
- Mit höhenverstellbaren Füßen
- Jede Schublade kann bis zu 4 tiefgezogene Schalen aus EVA-Schaum oder ABS aufnehmen

		max
70 mm	25 kg	
280 mm	35 kg	

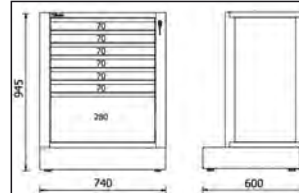
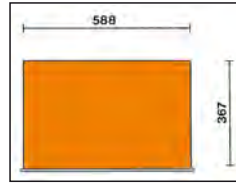

52 kg



RSC50 M7

€ 1.850,00 1 050001227

RSC50 M8

Festes Modul mit 8 Schubladen, für Werkstattausrüstungskombination RSC50

- 8 Schubladen (588x367 mm) mit kugelgelagerten Führungen
- Schubladenböden durch Moosgummimatten geschützt
- Zentralverriegelung vorne
- Mit höhenverstellbaren Füßen
- Jede Schublade kann bis zu 4 tiefgezogene Schalen aus EVA-Schaum oder ABS aufnehmen

		max
70 mm	25 kg	
140 mm	30 kg	

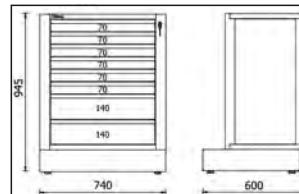
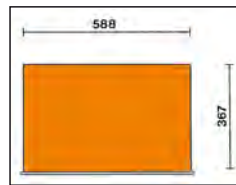

53,2 kg



RSC50 M8

€ 1.900,00 1 050001228

RSC50 M10

Festes Modul mit 10 Schubladen, für Werkstattausrüstungskombination RSC50

- 10 Schubladen (588x367 mm) mit kugelgelagerten Führungen
- Schubladenböden durch Moosgummimatten geschützt
- Zentralverriegelung vorne
- Mit höhenverstellbaren Füßen
- Jede Schublade kann bis zu 4 tiefgezogene Schalen aus EVA-Schaum oder ABS aufnehmen

		max
70 mm	25 kg	

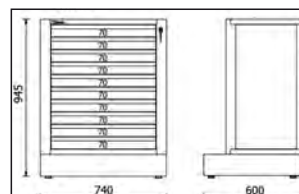
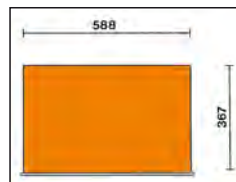

58,2 kg

RSC50 M10

€ 1.990,00 1 050001230

RSC50 MS-2C

festes Servicemodul, für Werkstattausrüstungskombination RSC50

- Eingebauter Abfallbehälter
- Papierrollenfach
- Zwei Schubladen, 310x370 mm, 180 mm hoch, mit kugelgelagerten Führungen (Innenmaße)
- Mit höhenverstellbaren Füßen

📦 57 kg

RSC50 MS-2C

€ 1.735,00 1 050001243

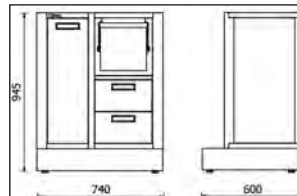

RSC50 MS-AVV

festes Servicemodul, für Werkstattausrüstungskombination RSC50, leer

Kann einen Aufroller aufnehmen, der aus den folgenden Modellen zu wählen ist:

- Druckluft-Schlauchaufroller Artikel 1900S 8x10
- Kabeltrommeln Artikel 1843 15-H05, 1844 10-H05, 1844 15-H05, 1844 15-H07, 1844 15-H05/SCK, 1844 15-H07/SCK, 1845 12-H05, 1846 10-H05, 1846 10-H07 und 1846 15-H05

- Eingebauter Papierkorb
- Papierrollenfach
- Mit höhenverstellbaren Füßen

📦 41,5 kg

RSC50 MS-AVV

€ 1.600,00 1 050001241

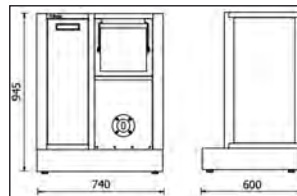

RSC50 MS-2AVV

festes Servicemodul, für Werkstattausrüstungskombination RSC50, leer

Kann zwei Aufroller aufnehmen, die aus den folgenden Modellen ausgewählt werden können:

- Druckluft-Schlauchaufroller Artikel 1900S 8x10
- Kabeltrommeln Artikel 1843 15-H05, 1844 10-H05, 1844 15-H05, 1844 15-H07, 1844 15-H05/SCK, 1844 15-H07/SCK, 1845 12-H05, 1846 10-H05, 1846 10-H07 und 1846 15-H05

- Eingebauter Papierkorb
- Papierrollenfach
- Mit höhenverstellbaren Füßen

📦 41,7 kg

RSC50 MS-2AVV

€ 1.660,00 1 050001242

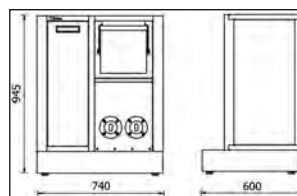

RSC50 MA

festes zweitüriges Modul, für Werkstattausrüstungskombination RSC50

- Mit Schloss
- Vertikal verstellbarer Innenboden
- Abmessungen innen: 615x435x740 mm
- Mit höhenverstellbaren Füßen

34 kg

RSC50 MA

€ 1.430,00 1 050001222

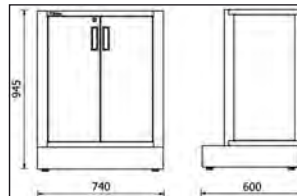

RSC50 CS

feststehendes, sortiertes Abfallsammelmodul, für Werkstattausrüstungskombination RSC50

- Ausziehbares Abfallfach (588x355x580 mm) mit kugelgelagerten Gleitschienen - 2 geräumige ausziehbare Innenbehälter zur Abfallsortierung
- Mit höhenverstellbaren Füßen

36 kg

RSC50 CS

€ 1.660,00 1 050001245

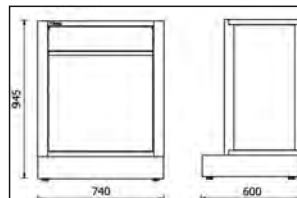

RSC50 ML

Festes Modul mit eingebauter Spüle, für Werkstattausrüstungskombination RSC50

Spezifikationen:

- Waschbecken aus rostfreiem Stahl
- Lieferung komplett mit:
 - 1 Mischbatterie
 - 1 Ablaufgarnitur
 - 1 Spülbeckenstöpsel
 - 1 Filterkappe
 - 1 Seifenspender

Festes zweitüriges Modul mit Schloss:

- Nutzbare Innenmaße: 615x435x575 mm
- Mit höhenverstellbaren Füßen

33,5 kg

RSC50 ML

€ 1.780,00 1 050001244

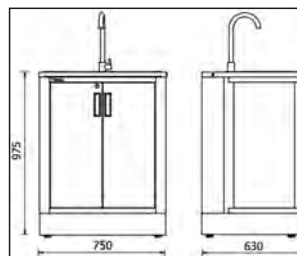

RSC50 MDO

Festes Ölverteilermodul, für Werkstattausrüstungskombination RSC50

- 2 Aufroller mit 7m - 1/2" Schlauch inklusive
- Komplett mit 2 Pistolen mit digitalem Literzähler und automatischer Tropfvorrichtung.
- max. Durchflussmenge: 30 l/min
- Viskosität: 8÷2000 mPas
- Mit vertikal verstellbaren Füßen

📦 74 kg

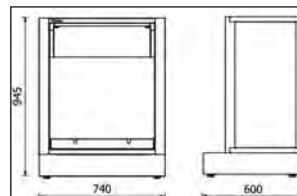

RSC50 MDO

€ 3.330,00 1 050001250

RSC50 T3

3-etagiger Werkzeugwagen, für Werkstattausrüstungskombination RSC50

- Vier Lenkrollen, Ø 100 mm (zwei mit Feststellern)
- Statische Belastbarkeit: 200 kg (verteilt auf 3 Böden)

📦 22,3 kg

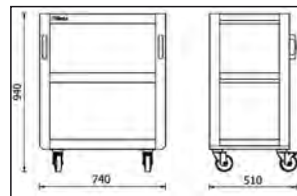

RSC50 T3

€ 391,00 1 050001253

Beta

RSC50 KPF

Satz gelochter Werkzeugtafeln, für Werkstattausrüstungskombination RSC50, bestehend aus:

- Eine obere gelochte Werkzeugplatte, 650x400x25 mm
- Eine untere gelochte Werkzeugplatte, 650x625x25 mm, kann eine 19"-Rack-Multifachsteckdose aufnehmen (nicht im Lieferumfang enthalten)
- Ein Paar rechte/linke Ständer



14,8 kg

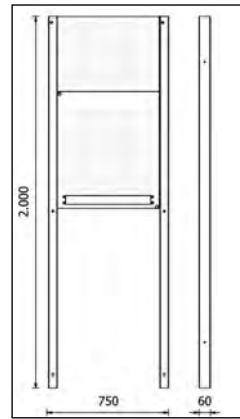

RSC50 KPF

€ 665,00 1 050001310

RSC50 PFS

obere gelochte Werkzeugtafel, für Werkstattausrüstungskombination RSC50

- Abmessungen: 650x400x25 mm

2,5 kg



RSC50 PFS

€ 190,00 1 050001312

RSC50 PFI

untere gelochte Werkzeugtafel, für Werkstattausrüstungskombination RSC50

- Abmessungen: 650x625x25 mm
- Kann eine 19"-Rack-Mehrfachsteckdose aufnehmen (nicht enthalten)

3,8 kg



RSC50 PFI

€ 217,00 1 050001313

RSC50 P/2MDX-SX

Ständerpaar rechts/links, für Werkstattausrüstungskombination RSC50

8,5 kg

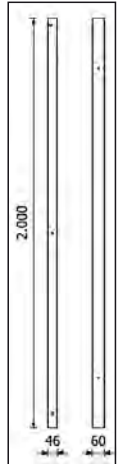

RSC50 P/2MDX-SX

€ 260,00



1



050001352

RSC50 PM

Wandschrank, für Werkstattausrüstung Kombination RSC50

- Abmessungen: 740x300x400 mm
- Ausgestattet mit Gasfedern, die das Öffnen und Schließen der Tür erleichtern
- Vorgesehen für den Einsatz von Aluminiumprofilen mit LED-Leisten Artikel 5000 RSC50/PLED oder 5000 RSC50/PLED-ST (separat zu bestellen), zur Beleuchtung des Arbeitsbereichs unter und/oder im Inneren des Hängeschanks.

14 kg



30 kg

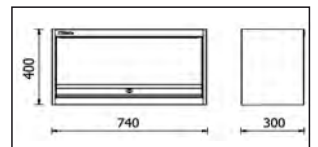

RSC50 PM

€ 617,00



1



050001302

RSC50 MTP

Dreieckige Ablage, für Werkstattausrüstung Kombination RSC50

- Abmessungen: 740x300x400 mm
- Konzipiert für die Anwendung von Aluminiumprofilen mit LED-Streifen Artikel 5000 RSC50/PLED oder 5000 RSC50/PLED-ST (separat zu bestellen), zur Beleuchtung des Arbeitsbereichs unter

6,5 kg



10 kg

RSC50 MTP

€ 315,00



1



050001305

Beta

RSC50 PS

Werkzeugwandsystem mit Rolltor, für
Werkstattausrüstungskombination RSC50

- Aluminium-Rolltor, höhenverstellbar, abschließbar
- Herausnehmbare Lochplatten für Werkzeuge
- Geliefert mit Rahmen

77 kg

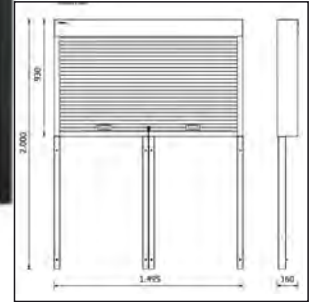

RSC50 PS	€ 2.790,00	1	050001360
----------	------------	---	-----------

RSC50 AC

selbsttragende Komplettecke, für Werkstattausrüstungskombination
RSC50

- Arbeitsplatte aus lackiertem Blech, 630x630x30 mm, mit stoßfester, kratzfester und kohlenwasserstoffbeständiger PVC-Beschichtung
- Zwei untere gelochte Werkzeugaufeln, 650x625x25 mm, zur Aufnahme eines 19"-Rack-Multisockels (nicht im Lieferumfang enthalten)
- Zwei obere gelochte Werkzeugaufeln, 650x400x25 mm
- Lieferung komplett mit Rahmen

41 kg



RAL 7016

RSC50 AC-A

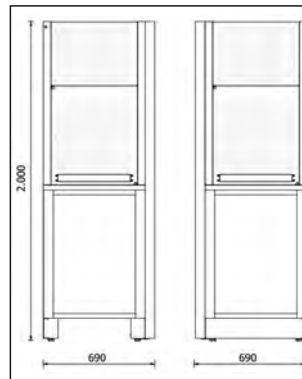

RAL 7046



RSC50 AC-G

RSC50 AC-G	€ 2.160,00	1	050001330
RSC50 AC-A	€ 2.160,00	1	050001329

RSC50 KAI

unteres Eckelement, 630x630 mm

- Arbeitsplatte aus lackiertem Blech (630x630 mm) mit stoßfester, kratzfester und kohlenwasserstoffbeständiger PVC-Beschichtung

16 kg



RAL 7046

RAL 7016

RSC50 KAI-A

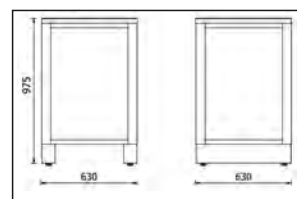

RSC50 KAI-G

RSC50 KAI-G	€ 1.245,00	1	050001335
RSC50 KAI-A	€ 1.245,00	1	050001336

RSC50 A1

Blechschränk, 1-türig, für Werkstatteinrichtung RSC50

- 4 herausnehmbare, höhenverstellbare Einlegeböden
- Praktische klappbare Kleiderstange unter dem ersten Fachboden
- Mit Schloss
- Innenmaße: 590x615 mm
- Mit höhenverstellbaren Füßen

📦 66 kg

RSC50 A1 € 983,00 1 050001411

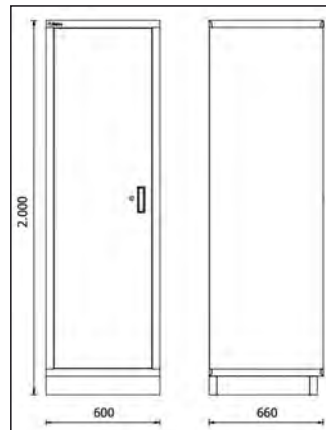

RSC50 A1/R59

Innerer Einlegeboden für Schrank RSC50 A1

RSC50 A1/R59 605x596 mm € 62,00 1 050001913



RSC50 A1/RB59

Innerer Einlegeboden für Schrank RSC50 A1 mit Kleiderstange

RSC50 A1/RB59 605x596 mm € 73,00 1 050001914

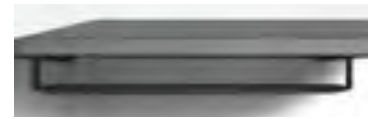
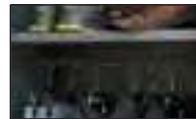

RSC50 A2

zweitüriger Werkzeugschränk aus Blech, für Werkstattausrüstung RSC50

- 4 herausnehmbare, höhenverstellbare Einlegeböden
- Mit Schloss:
- Innenmaße: 910x615 mm
- Mit höhenverstellbaren Füßen

📦 90 kg

RSC50 A2 € 1.510,00 1 050001412



RSC50 A2/R91

Innerer Einlegeboden für Schrank RSC50 A2

RSC50 A2/R91 911x596 mm € 89,00 1 050001915



5000 RSC50/MP

Regal, für Werkstattausrüstung Kombination RSC50

- Abmessungen: 740x140x80 mm
- Vorgesehen für die Anwendung von Aluminiumprofilen mit LED-Streifen Artikel 5000 RSC50/PLED oder 5000 RSC50/PLED-ST (separat zu bestellen), um den Arbeitsbereich darunter zu beleuchten



2,3 kg

5000 RSC50/MP	€ 143,00	1	050001705
---------------	----------	---	-----------

5000 RSC50/MPA140

Eckregal, 140 mm tief, für Werkstattgerätekombination RSC50

- Abmessungen: 630x630x35 mm, 140 mm tief
- Anzuwenden auf gelochten Platten des Eckmoduls RSC50 AC
- Vorgesehen für die Anwendung von Aluminiumprofilen mit LED-Streifen Artikel 5000 RSC50/PLED oder 5000 RSC50/PLED-ST (separat zu bestellen), um den Arbeitsbereich darunter zu beleuchten



3 kg

5000 RSC50/MPA140	€ 189,00	1	050001706
-------------------	----------	---	-----------

5000 RSC50/CLL

linearer Schutz, für Werkstattgerätekombination RSC50

- Abmessungen: 740x125x30 mm
- Zum Anbringen an gelochten Werkzeugaufeln
- Vorgesehen für die Anwendung von Aluminiumprofilen mit LED-Streifen Artikel 5000 RSC50/PLED oder 5000 RSC50/PLED-ST (separat zu bestellen), um den Arbeitsbereich darunter zu beleuchten



1 kg

5000 RSC50/CLL	€ 143,00	1	050001710
----------------	----------	---	-----------

5000 RSC50/CAL

Eckschutz, für Werkstattgerätekombination RSC50

- Abmessungen: 655x655x30 mm
- Zur Anbringung an gelochten Werkzeugaufeln des Eckmoduls
- Vorgesehen für die Anwendung von Aluminiumprofilen mit LED-Streifen Artikel 5000 RSC50/PLED oder 5000 RSC50/PLED-ST (separat zu bestellen), um den Arbeitsbereich darunter zu beleuchten



1,7 kg

5000 RSC50/CAL	€ 189,00	1	050001711
----------------	----------	---	-----------

5000 RSC50/KFC

Bausatz mit 10 farbigen Schubladenfronten, für Werkstattausrüstungskombination RSC50

- Zur individuellen Farbgestaltung von Schubladenfronten für die Werkstattausrüstungskombination RSC50.
- Empfohlen für die Verwendung in Kombination mit Arbeitsplatten in Anthrazitgrau RAL7016 (-A).



5000 RSC50/KFC2011	€ 99,50	1	050001731
5000 RSC50/KFC3000	€ 99,50	1	050001733
5000 RSC50/KFC5015	€ 99,50	1	050001734
5000 RSC50/KFC7016	€ 99,50	1	050001737

PROFESSIONELL - STABIL - AUFGERÄUMT

C45PRO ist das professionelle Werkstatteinrichtungssystem, um den eigenen Arbeitsplatz bestens zu organisieren. Das neue Design 2021 und die an der Struktur vorgenommenen technischen Verbesserungen garantieren ein optimales Qualität-/Preisverhältnis.

Die **modulare Werkstatteinrichtung C45PRO** ermöglicht die Gestaltung Ihrer Arbeitsumgebung entsprechend den zur Verfügung stehenden Räumen und der Nutzungsansprüche. Es handelt sich um eine einfache und flexible Reihe mit vorbestimmten Kombinationen, die erweitert und später auch geändert werden kann. Alternativ hierzu ist es möglich, den personalisierten Arbeitsplatz vollständig zu konstruieren, angefangen mit den Arbeitsplatten – verfügbar aus MDF mit rostfreier Stahlbeschichtung oder aus Multiplex-Holz – bis hin zu den zahlreichen Komponenten und verfügbaren Zubehörteilen.

Gestalten Sie Ihre Arbeitsumgebungen entsprechend Ihren Ansprüchen. Ändern Sie das „Gesicht“ Ihres Atelier oder Ihrer Werkstatt. Wählen Sie vormontierte Lösungen aus oder planen Sie vollständig neu Ihren Arbeitsplatz



DIE WERKSTATTEINRICHTUNG C45 WECHSELT IHR AUSSEHEN UND TRÄGT DIE BETA FARBEN!

konfigurieren Sie on-line Ihre Werkstatt



go to www.beta-tools.com

C45PRO DX

Kombi-Werkstatteinrichtung C45PRO

Kombi-Werkstatteinrichtung bestehend aus:

- 1 Arbeitsplatte aus MDF mit rostfreier Stahlbeschichtung (C45PX/3-2,0MT)
- 1 Arbeitsplatte aus MDF mit rostfreier Stahlbeschichtung (C45PX/2-1,3MT)
- 1 festes Modul mit 7 Schubladen (C45PRO M7)
- 1 Werkzeugwagen mit 7 Schubladen (C45PRO C7)
- 1 festes Servicemodul (C45PRO MS)
- 1 festes Modul mit 5 Schubladen (C45PRO M5)
- 1 festes Modul mit 2 Türen (C45PRO MA)
- 1 Komplettecke, selbsttragend, mit Arbeitsplatte aus MDF mit rostfreier Stahlbeschichtung (C45PRO CORNER/X)
- 5 Werkzeuglochplatten (C45PRO PF)
- 5 Wandhängeschränke (C45PRO PM)
- 7 Bügel für Wand, breiter Typ (C45PRO SL)
- 2 Bügel für Wand, schmaler Typ (C45PRO SS)
- 2 1-türige Schränke (C45PRO AS1)

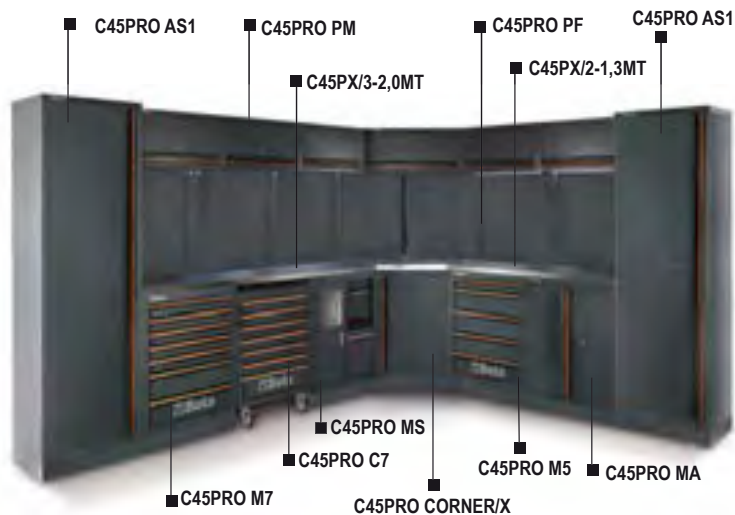

572,3 kg

C45PRO DX

€ 11.030,00 1 045000031

2000
1850
3530
2850

C45PRO DW

Kombi-Werkstatteinrichtung C45PRO

Kombi-Werkstatteinrichtung bestehend aus:

- 1 Multiplex-Arbeitsplatte (C45PW/3-2,0MT)
- 1 Multiplex-Arbeitsplatte (C45PW/2-1,3MT)
- 1 festes Modul mit 7 Schubladen (C45PRO M7)
- 1 Werkzeugwagen mit 7 Schubladen (C45PRO C7)
- 1 festes Servicemodul (C45PRO MS)
- 1 festes Modul mit 5 Schubladen (C45PRO M5)
- 1 festes Modul mit 2 Türen (C45PRO MA)
- 1 Komplettecke, selbsttragend, mit Arbeitsplatte aus Holz (C45PRO CORNER/W)
- 5 Werkzeuglochplatten (C45PRO PF)
- 5 Wandhängeschränke (C45PRO PM)
- 7 Bügel für Wand, breiter Typ (C45PRO SL)
- 2 Bügel für Wand, schmaler Typ (C45PRO SS)
- 2 1-türige Schränke (C45PRO AS1)

568,5 kg

C45PRO DW € 10.660,00 1 045000032

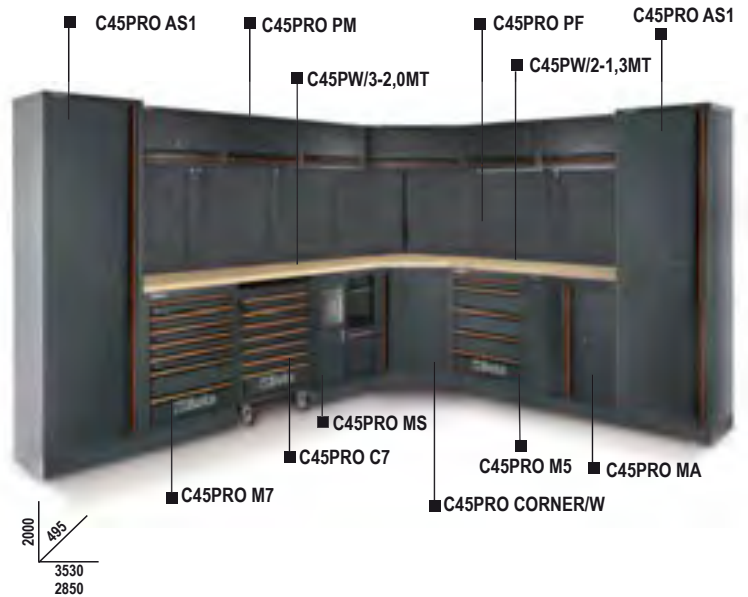

C45PRO FX

Kombi-Werkstatteinrichtung C45PRO

Kombi-Werkstatteinrichtung bestehend aus:

- 1 Arbeitsplatte aus MDF mit rostfreier Stahlbeschichtung (C45PX/3-2,0MT)
- 1 Arbeitsplatte aus MDF mit rostfreier Stahlbeschichtung (C45PX/2-1,3MT)
- 1 festes Modul, 2-türig (C45PRO MA)
- 1 Werkzeugwagen mit 7 Schubladen (C45PRO C7)
- 1 festes Modul mit 7 Schubladen (C45PRO M7)
- 1 festes Modul mit zwei integrierten Aufrollern (C45PRO ACT)
- 1 festes Servicemodul (C45PRO MS)
- 1 Komplettecke, selbsttragend, mit Arbeitsplatte aus MDF mit rostfreier Beschichtung (C45PRO CORNER/X)
- 2 Werkzeuglochplatten (C45PRO PF)
- 1 Werkzeuglochplatte ausgelegt für das Anbringen einer Stockdose, im Lieferumfang nicht enthalten (C45PRO PFE)
- 3 Wandhängeschränke (C45PRO PM)
- 1 Werkzeugwand mit Aluminiumrollladen (C45PRO PA)
- 6 Wandbügel, breiter Typ (C45PRO SL)
- 2 Wandbügel, schmaler Typ (C45PRO SS)
- 2 1-türige Schränke (C45PRO AS1)

576 kg

C45PRO FX € 11.720,00 1 045000035

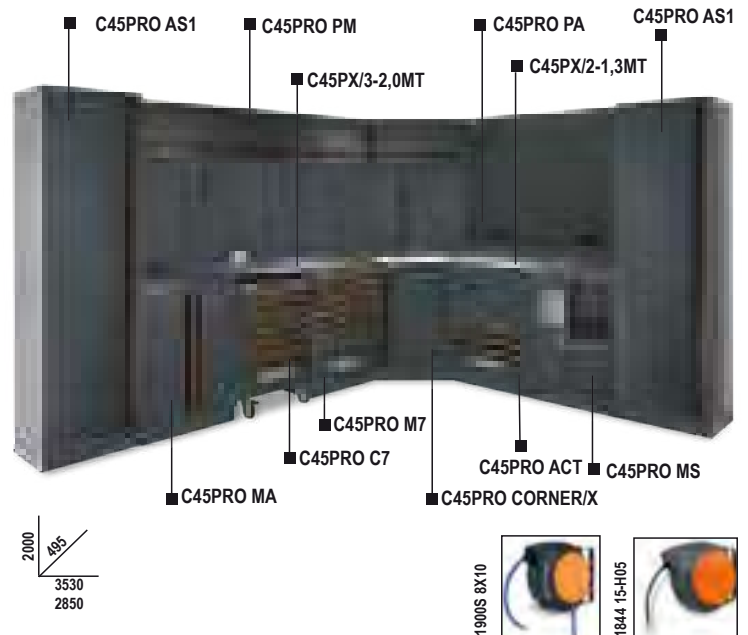

C45PRO FW

Kombi-Werkstatteinrichtung C45PRO

Kombi-Werkstatteinrichtung bestehend aus:

- 1 Multiplex-Arbeitsplatte (C45PW/3-2,0MT)
- 1 Multiplex-Arbeitsplatte (C45PW/2-1,3MT)
- 1 festes Modul, 2-türig (C45PRO MA)
- 1 Werkzeugwagen mit 7 Schubladen (C45PRO C7)
- 1 festes Modul mit 7 Schubladen (C45PRO M7)
- 1 festes Modul mit zwei integrierten Aufrollern (C45PRO ACT)
- 1 festes Servicemodul (C45PRO MS)
- 1 Komplettecke, selbsttragend, mit Multiplex-Arbeitsplatte (C45PRO CORNER/W)
- 2 Werkzeuglochplatten (C45PRO PF)
- 1 Werkzeuglochplatte ausgelegt für das Anbringen einer Stockdose, im Lieferumfang nicht enthalten (C45PRO PFE)
- 3 Wandhängeschränke (C45PRO PM)
- 1 Werkzeugwand mit Aluminiumrollladen (C45PRO PA)
- 6 Wandbügel, breiter Typ (C45PRO SL)
- 2 Wandbügel, schmaler Typ (C45PRO SS)
- 2 1-türige Schränke (C45PRO AS1)

572 kg

C45PRO FW € 11.340,00 1 045000045

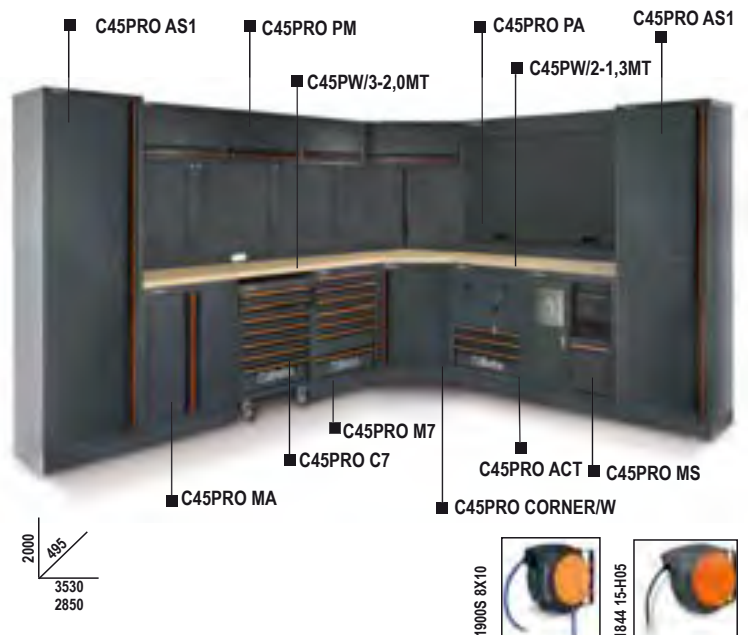

C45PRO GX

Kombi-Werkstatteinrichtung C45PRO

Kombi-Werkstatteinrichtung bestehend aus:

- 1 Arbeitsplatte aus MDF mit rostfreier Stahlbeschichtung (C45PX/3-2,0MT)
- 1 Arbeitsplatte aus MDF mit rostfreier Stahlbeschichtung (C45PX/1-0,7MT)
- 1 festes Modul mit zwei integrierten Aufrollern (C45PRO ACT)
- 1 Werkzeugwagen mit 7 Schubladen (C45PRO C7)
- 1 festes Modul mit 7 Schubladen (C45PRO M7)
- 1 festes Modul, 2-türig (C45PRO MA)
- 1 Komplettecke, selbsttragend, mit Arbeitsplatte aus MDF mit rostfreier Beschichtung (C45PRO CORNER/X)
- 1 Werkzeuglochplatte (C45PRO PF)
- 1 Werkzeuglochplatte ausgelegt für das Anbringen einer Stockdose, im Lieferumfang nicht enthalten (C45PRO PFE)
- 2 Wandhängeschränke (C45PRO PM)
- 1 Werkzeugwand mit Aluminiumrollladen (C45PRO PAS)
- 6 Wandbügel, breiter Typ (C45PRO SL)
- 2 Wandbügel, schmaler Typ (C45PRO SS)
- 2 1-türige Schränke (C45PRO AS1)

507 kg

C45PRO GX € 10.460,00 1 045000036

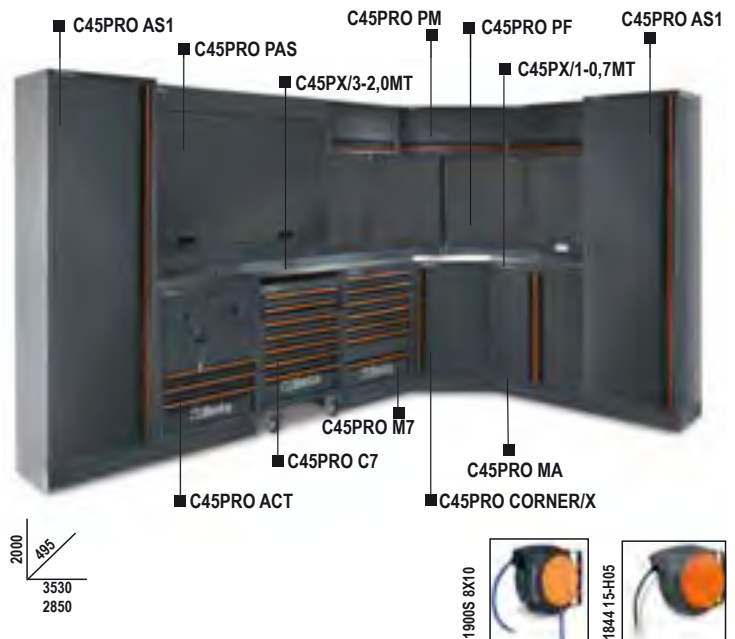

C45PRO GW

Kombi-Werkstatteinrichtung C45PRO

Kombi-Werkstatteinrichtung bestehend aus:

- 1 Multiplex-Arbeitsplatte (C45PW/3-2,0MT)
- 1 Multiplex-Arbeitsplatte (C45PW/1-0,7MT)
- 1 festes Modul mit zwei integrierten Aufrollern (C45PRO ACT)
- 1 Werkzeugwagen mit 7 Schubladen (C45PRO C7)
- 1 festes Modul mit 7 Schubladen (C45PRO M7)
- 1 festes Modul mit integriertem Waschbecken (C45PRO ML)
- 1 Komplettecke, selbsttragend, mit Multiplex-Arbeitsplatte (C45PRO CORNER/W)
- 1 Werkzeuglochplatte (C45PRO PF)
- 1 Werkzeuglochplatte ausgelegt für das Anbringen einer Stockdose, im Lieferumfang nicht enthalten (C45PRO PFE)
- 2 Wandhängeschränke (C45PRO PM)
- 1 Werkzeugwand mit Aluminiumrollladen (C45PRO PAS)
- 6 Wandbügel, breiter Typ (C45PRO SL)
- 2 Wandbügel, breiter Typ (C45PRO SS)
- 2 1-türige Schränke (C45PRO AS1)

504 kg

C45PRO GW € 10.130,00 1 045000037

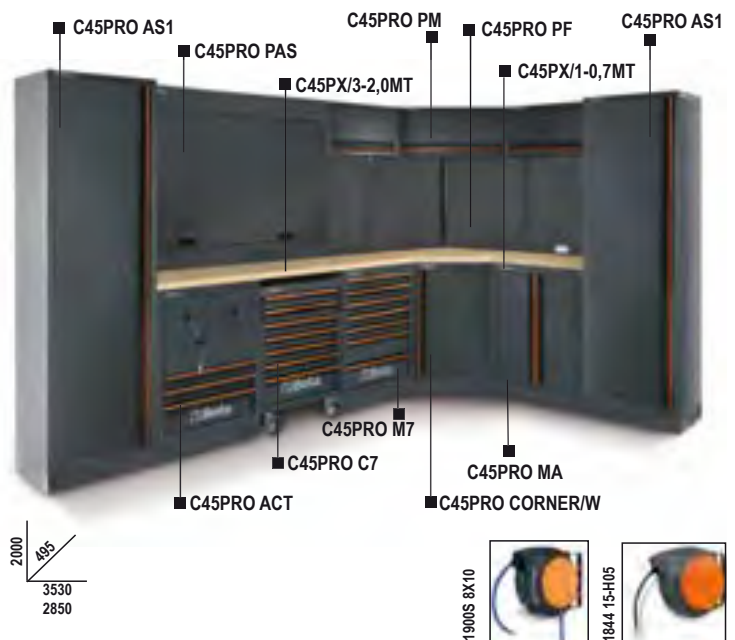

C45PRO X

Kombi-Werkstatteinrichtung C45PRO

Kombi-Werkstatteinrichtung bestehend aus:

- Arbeitsplatte aus MDF mit rostfreier Stahlbeschichtung (C45PX/3-2,0MT)
- Festes Modul mit 7 Schubladen (C45PRO M7)
- Festes Servicemodul (C45PRO MS)
- Werkzeugwagen mit 7 Schubladen (C45PRO C7)
- 2-türiger Schrank (C45PRO AS2)
- 3 Werkzeuglochplatten (C45PRO PF)
- 3 Wandhängeschränke (C45PRO PM)
- 3 Bügel für Wand, breiter Typ (C45PRO SL)
- 1 Bügel für Wand, schmaler Typ (C45PRO SS)

305 kg

C45PRO X € 5.580,00 1 045000001

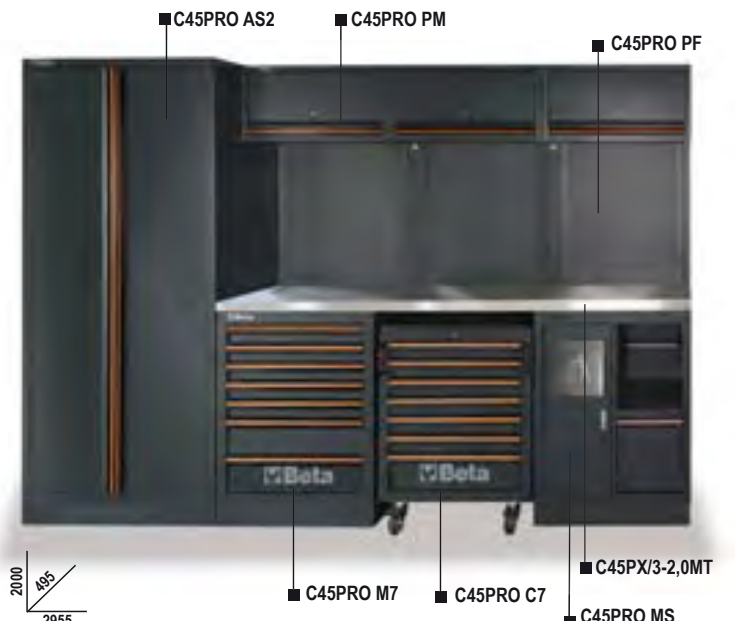

C45PRO W

Kombi-Werkstatteinrichtung C45PRO

Kombi-Werkstatteinrichtung bestehend aus:

- Multiplex-Arbeitsplatte (C45PW/3-2,0MT)
- Festes Modul mit 7 Schubladen (C45PRO M7)
- Festes Servicemodul (C45PRO MS)
- Werkzeugwagen mit 7 Schubladen (C45PRO C7)
- 2-türiger Schrank (C45PRO AS2)
- 3 Werkzeuglochplatten (C45PRO PF)
- 3 Wandhängeschränke (C45PRO PM)
- 3 Bügel für Wand, breiter Typ (C45PRO SL)
- 1 Bügel für Wand, schmaler Typ (C45PRO SS)

303 kg

C45PRO W

€ 5.430,00 1 045000002

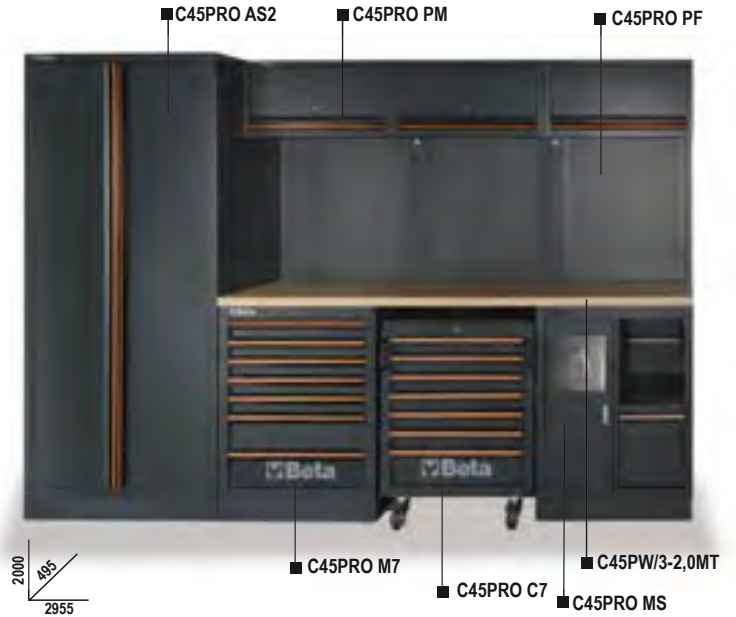

C45PRO HX

Kombi-Werkstatteinrichtung C45PRO

Kombi-Werkstatteinrichtung bestehend aus:

- 1 Arbeitsplatte aus MDF mit rostfreier Stahlbeschichtung (C45PX/3-2,0MT)
- 1 festes Modul mit zwei integrierten Aufrollern (C45PRO ACT)
- 1 Werkzeugwagen mit 7 Schubladen (C45PRO C7)
- 1 festes Modul mit 4 Schubladen (C45PRO M4)
- 3 Wandhängeschränke (C45PRO PM)
- 3 Werkzeuglochplatten (C45PRO PF)
- 3 Wandbügel, breiter Typ (C45PRO SL)
- 1 Wandbügel, schmaler Typ (C45PRO SS)
- 1 2-türiger Schrank (C45PRO AS2)

300 kg

C45PRO HX

€ 6.020,00 1 045000038

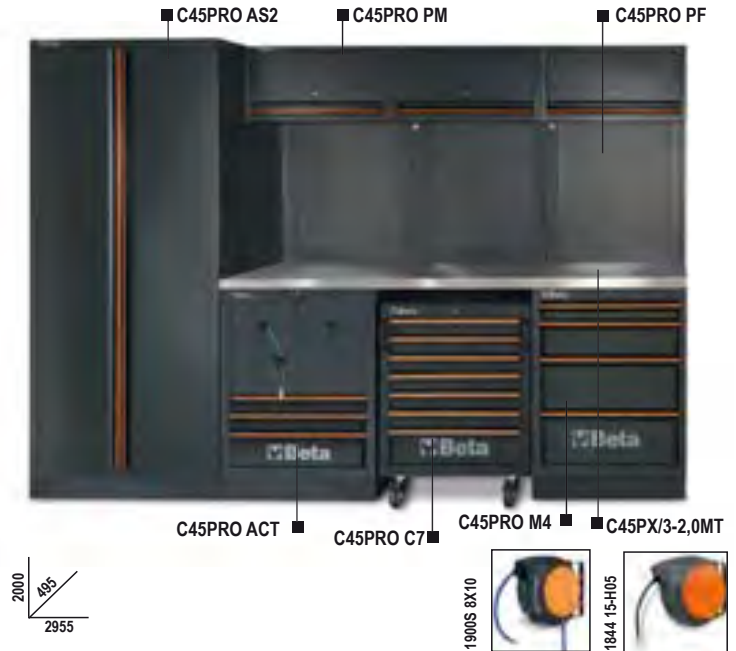

C45PRO HW

Kombi-Werkstatteinrichtung C45PRO

Kombi-Werkstatteinrichtung bestehend aus:

- 1 Multiplex-Arbeitsplatte (C45PW/3-2,0MT)
- 1 festes Modul mit zwei integrierten Aufrollern (C45PRO ACT)
- 1 Werkzeugwagen mit 7 Schubladen (C45PRO C7)
- 1 festes Modul mit 4 Schubladen (C45PRO M4)
- 3 Wandhängeschränke (C45PRO PM)
- 3 Werkzeuglochplatten (C45PRO PF)
- 3 Wandbügel, breiter Typ (C45PRO SL)
- 1 Wandbügel, schmaler Typ (C45PRO SS)
- 1 2-türiger Schrank (C45PRO AS2)

299 kg

C45PRO HW

€ 5.870,00 1 045000039

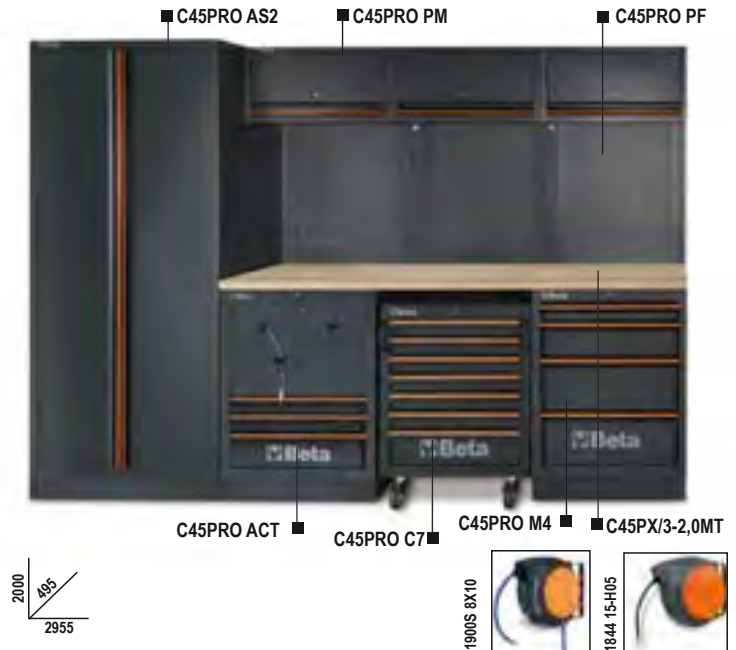

C45PRO AX

Kombi-Werkstatteinrichtung C45PRO

Kombi-Werkstatteinrichtung bestehend aus:

- Arbeitsplatte aus MDF mit rostfreier Stahlbeschichtung (C45PX/3-2,0MT)
- Festes Modul mit 7 Schubladen (C45PRO M7)
- Festes Servicemodul (C45PRO MS)
- Festes Modul mit 2 Türen (C45PRO MA)
- 3 Wandhängeschränke (C45PRO PM)
- 3 Werkzeuglochplatten (C45PRO PF)
- 2 Bügel für Wand, breiter Typ (C45PRO SL)
- 2 Bügel für Wand, schmaler Typ (C45PRO SS)

206 kg

C45PRO AX

3.880,00

1

045000003



C45PRO AW

Kombi-Werkstatteinrichtung C45PRO

Kombi-Werkstatteinrichtung bestehend aus:

- Multiplex-Arbeitsplatte (C45PW/3-2,0MT)
- Festes Modul mit 2 Türen (C45PRO MA)
- Festes Modul mit 7 Schubladen (C45PRO M7)
- Festes Servicemodul (C45PRO MS)
- 3 Wandhängeschränke (C45PRO PM)
- 3 Werkzeuglochplatten (C45PRO PF)
- 2 Bügel für Wand, schmaler Typ (C45PRO SS)
- 2 Bügel für Wand, breiter Typ (C45PRO SL)

204 kg

C45PRO AW

3.730,00

1

045000004



C45PRO BX

Kombi-Werkstatteinrichtung C45PRO

Kombi-Werkstatteinrichtung bestehend aus:

- Arbeitsplatte aus MDF mit rostfreier Stahlbeschichtung (C45PX/2-1,3MT)
- Festes Modul mit 5 Schubladen (C45PRO M5)
- Festes Modul mit 2 Türen (C45PRO MA)
- 1-türiger Schrank (C45PRO AS1)
- 2 Wandhängeschränke (C45PRO PM)
- 2 Werkzeuglochplatten (C45PRO PF)
- 2 Bügel für Wand, breiter Typ (C45PRO SL)
- 1 Bügel für Wand, schmaler Typ (C45PRO SS)

191 kg

C45PRO BX

3.490,00

1

045000021



C45PRO BW

Kombi-Werkstatteinrichtung C45PRO

Kombi-Werkstatteinrichtung bestehend aus:

- Multiplex-Arbeitsplatte (C45PW/2-1,3MT)
- Festes Modul mit 5 Schubladen (C45PRO M5)
- Festes Modul mit 2 Türen (C45PRO MA)
- 1-türiger Schrank (C45PRO AS1)
- 2 Wandhängeschränke (C45PRO PM)
- 2 Werkzeuglochplatten (C45PRO PF)
- 2 Bügel für Wand, breiter Typ (C45PRO SL)
- 1 Bügel für Wand, schmaler Typ (C45PRO SS)

190 kg

C45PRO BW

€ 3.350,00 1 045000022



C45PRO EX

Kombi-Werkstatteinrichtung C45PRO

Kombi-Werkstatteinrichtung bestehend aus:

- 2 Werkzeuglochplatten (C45PRO PF)
- 2 Wandhängeschränke (C45PRO PM)
- 2 Wandbügel, breiter Typ (C45PRO SL)
- 1 Wandbügel, schmaler Typ (C45PRO SS)
- 1-türiger Schrank (C45PRO AS1)
- Festes Modul mit 7 Schubladen und Arbeitsplatte aus MDF mit rostfreier Stahlbeschichtung (C45PRO M7A/X):
 - 1 Schublade 1248x406 mm
 - 6 Schubladen 782x406 mm
 - 5 Schubladen Höhe 65 mm
 - 1 Schublade Höhe 145 mm
- 1 Aufbewahrungsfach mit Zwischenboden und Verschlussür

174,6 kg

C45PRO EX

€ 3.710,00 1 045000033

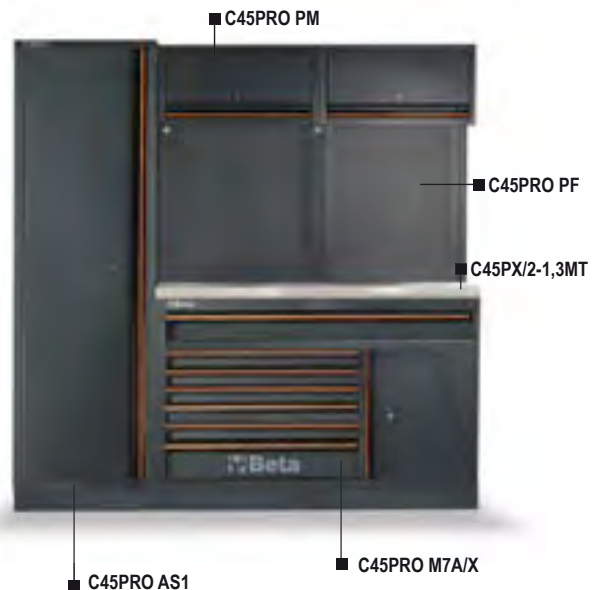

C45PRO EW

Kombi-Werkstatteinrichtung C45PRO

Kombi-Werkstatteinrichtung bestehend aus:

- 2 Werkzeuglochplatten (C45PRO PF)
- 2 Wandhängeschränke (C45PRO PM)
- 2 Wandbügel, breiter Typ (C45PRO SL)
- 1 Wandbügel, schmaler Typ (C45PRO SS)
- 1-türiger Schrank (C45PRO AS1)
- Festes Modul mit 7 Schubladen und Multiplex-Arbeitsplatte (C45PRO M7A/W):
 - 1 Schublade 1248x406 mm
 - 6 Schubladen 782x406 mm
 - 5 Schubladen Höhe 65 mm
 - 1 Schublade Höhe 145 mm
- 1 Aufbewahrungsfach mit Zwischenboden und Verschlussür

173,6 kg

C45PRO EW

€ 3.580,00 1 045000034

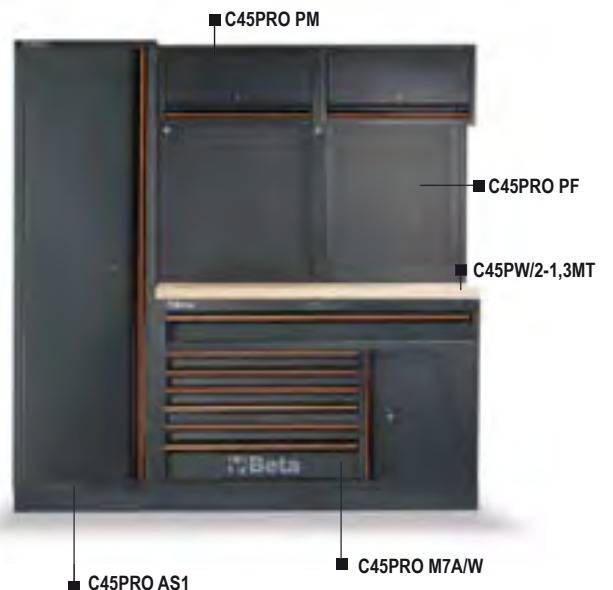

C45PRO CX

Kombi-Werkstatteinrichtung C45PRO

Kombi-Werkstatteinrichtung bestehend aus:

- Arbeitsplatte aus MDF mit rostfreier Stahlbeschichtung (C45PX/2-1,3MT)
- Feststehendes Modul mit 7 Schubladen (C45PRO M7)
- Feststehendes Servicemodul (C45PRO MS)
- 1-türiger Schrank (C45PRO AS1)
- 2 Wandhängeschränke (C45PRO PM)
- 2 Werkzeuglochplatten (C45PRO PF)
- 2 Wandbügel, breiter Typ (C45PRO SL)
- 1 Wandbügel, schmaler Typ (C45PRO SS)

199 kg

C45PRO CX

3.740,00

1

045000023



C45PRO CW

Kombi-Werkstatteinrichtung C45PRO

Kombi-Werkstatteinrichtung bestehend aus:

- Multiplex-Arbeitsplatte (C45PW/2-1,3MT)
- Festes Modul mit 7 Schubladen (C45PRO M7)
- Festes Servicemodul (C45PRO MS)
- 1-türiger Schrank (C45PRO AS1)
- 2 Wandhängeschränke (C45PRO PM)
- 2 Werkzeuglochplatten (C45PRO PF)
- 2 Wandbügel, breiter Typ (C45PRO SL)
- 1 Wandbügel, schmaler Typ (C45PRO SS)

198 kg

C45PRO CW

3.600,00

1

045000024



C45PRO BPX-2,0

Kombi-Werkbänke für Werkstatteinrichtung C45PRO

Kombi-Werkstatteinrichtung bestehend aus:

- Arbeitsplatte aus MDF mit rostfreier Stahlbeschichtung (C45PX/3-2,0MT)
- Festes Modul mit 7 Schubladen (C45PRO M7)
- Festes Modul mit 5 Schubladen (C45PRO M5)
- 3 Werkzeuglochplatten (C45PRO PF)
- 2 Wandbügel, breiter Typ (C45PRO SL)
- 2 Wandbügel, schmaler Typ (C45PRO SS)

158 kg

C45PRO BPX-2,0

2.830,00

1

045000042

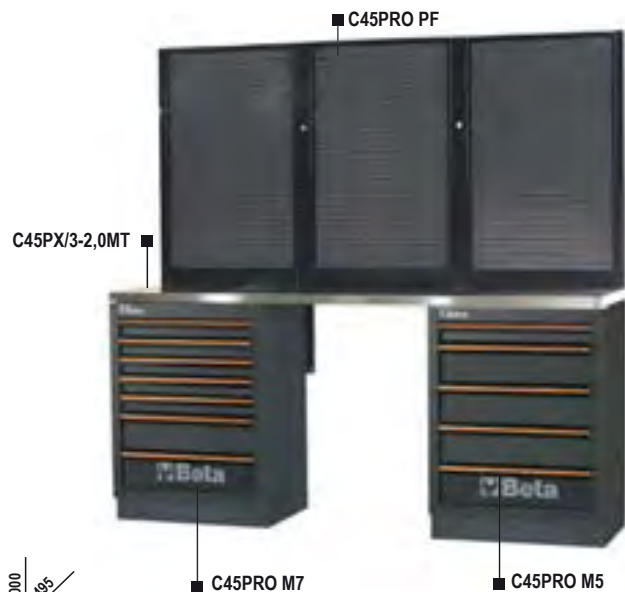

C45PRO BPW-2,0

Kombi-Werkbänke für Werkstatteinrichtung C45PRO

Kombi-Werkstatteinrichtung bestehend aus:

- Multiplex-Arbeitsplatte (C45PW/3-2,0MT)
- Festes Modul mit 7 Schubladen (C45PRO M7)
- Festes Modul mit 5 Schubladen (C45PRO M5)
- 3 Werkzeuglochplatten (C45PRO PF)
- 2 Wandbügel, breiter Typ (C45PRO SL)
- 2 Wandbügel, schmaler Typ (C45PRO SS)

156 kg

C45PRO BPW-2,0

€ 2.680,00 1 045000052



C45PRO BPX-1,3

Kombi-Werkbänke für Werkstatteinrichtung C45PRO

Kombi-Werkstatteinrichtung bestehend aus:

- Arbeitsplatte aus MDF mit rostfreier Stahlbeschichtung (C45PX/2-1,3MT)
- Festes Modul mit 7 Schubladen (C45PRO M7)
- Festes Modul mit 5 Schubladen (C45PRO M5)
- 2 Werkzeuglochplatten (C45PRO PF)
- 1 Wandbügel, breiter Typ (C45PRO SL)
- 2 Wandbügel, schmaler Typ (C45PRO SS)

140 kg

C45PRO BPX-1,3

€ 2.510,00 1 045000041



C45PRO BPW-1,3

Kombi-Werkbänke für Werkstatteinrichtung C45PRO

Kombi-Werkstatteinrichtung bestehend aus:

- Multiplex-Arbeitsplatte (C45PW/2-1,3MT)
- Festes Modul mit 7 Schubladen (C45PRO M7)
- Festes Modul mit 5 Schubladen (C45PRO M5)
- 2 Werkzeuglochplatten (C45PRO PF)
- 1 Wandbügel, breiter Typ (C45PRO SL)
- 2 Wandbügel, schmaler Typ (C45PRO SS)

139 kg

C45PRO BPW-1,3

€ 2.365,00 1 045000051



C45PRO M7A/X

Feststehendes Modul mit 7 Schubladen für Werkstatteinrichtung
C45PRO

- Arbeitsplatte aus MDF mit rostfreier Stahlbeschichtung, 1360 mm
- 1 Schublade mit Teleskopführungen, kugelgelagert, 1248x406 mm
- 6 Schubladen mit Teleskopführungen, kugelgelagert, 782x406 mm:
- 5 Schubladen Höhe 65 mm
- 1 Schublade Höhe 145 mm
- Schubladenböden mit Schaumgummibelag
- Zentralverriegelung mit vorderem Schloss
- Mit höhenverstellbaren Füßen
- Ausgelegt zum Einfügen von Thermoformateinsätzen
- 1 Aufbewahrungsfach mit Zwischenboden und Verschlussür, Innenabmessungen, 504x424x597 mm
- Bohrungen zum Einbringen eines Schraubstocks (Art. 1599P/150, separat zu bestellen)

81 kg

C45PRO M7A/X € 1.870,00 1 045000161



h	max
65 mm	25 kg
105 mm	40 kg
145 mm	30 kg

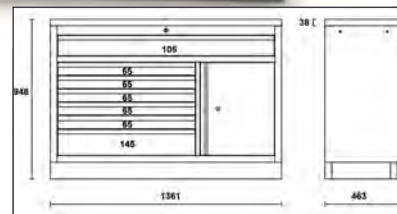

C45PRO M7A/W

Feststehendes Modul mit 7 Schubladen für Werkstatteinrichtung
C45PRO

- Multiplex-Arbeitsplatte, 1360 mm
- 1 Schublade mit Teleskopführungen, kugelgelagert, 1248x406 mm
- 6 Schubladen mit Teleskopführungen, kugelgelagert, 782x406 mm:
- 5 Schubladen Höhe 65 mm
- 1 Schublade Höhe 145 mm
- Schubladenböden mit Schaumgummibelag
- Zentralverriegelung mit vorderem Schloss
- Mit höhenverstellbaren Füßen
- Ausgelegt zum Einfügen von Thermoformateinsätzen
- 1 Aufbewahrungsfach mit Zwischenboden und Verschlussür, Innenabmessungen, 504x424x597 mm
- Bohrungen zum Einbringen eines Schraubstocks (Art. 1599P/150, separat zu bestellen)

80 kg

C45PRO M7A/W € 1.745,00 1 045000171



h	max
65 mm	25 kg
105 mm	40 kg
145 mm	30 kg

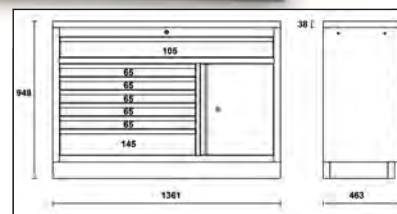

C45PRO MWS/X

Werkzeugwagen Work Station mit 7 Schubladen und eingebautem Mülleimer

- Arbeitsplatte aus MDF mit rostfreier Stahlbeschichtung, 1680 mm
- 1 Schublade mit Teleskopführungen, kugelgelagert, 1248x406 mm
- 6 Schubladen mit Teleskopführungen, kugelgelagert, 782x406 mm:
- 5 Schubladen Höhe 65 mm
- 1 Schublade Höhe 145 mm
- Schubladenböden mit Schaumgummibelag
- Ausgelegt zum Einfügen von Thermoformateinsätzen
- Aufbewahrungsfach mit Zwischenboden und Verschlussür, Innenabmessungen, 504x424x597 mm
- Eingebauter Mülleimer
- Integrierter Papierrollenhalter
- 4 Räder mit hoher Tragkraft, Ø 150 mm, 2 feste und 2 drehbare mit Bremse
- Zentralverriegelung mit vorderem Schloss
- Bohrungen zum Einbringen eines Schraubstocks (Art. 1599P/150, separat zu bestellen)

126 kg

C45PRO MWS/X € 1.980,00 1 045000181



h	max
65 mm	25 kg
105 mm	40 kg
145 mm	30 kg

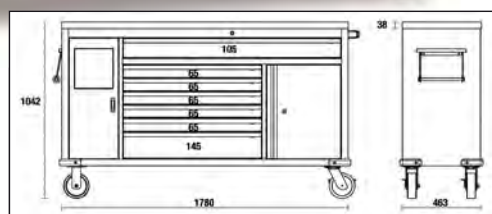

C45PRO MWS/W

Werkzeugwagen Work Station mit 7 Schubladen und eingebautem Mülleimer

- Multiplex-Arbeitsplatte, 1680 mm
- 1 Schublade mit Teleskopführungen, kugelgelagert, 1248x406 mm
- 6 Schubladen mit Teleskopführungen, kugelgelagert, 782x406 mm: 5 Schubladen Höhe 65 mm 1 Schublade Höhe 145 mm
- Schubladenböden mit Schaumgummibelag
- Ausgelegt zum Einfügen von Thermoformateinsätzen
- Aufbewahrungsfach mit Zwischenboden und Verschlussstür, Innenabmessungen, 504x424x597 mm
- Eingebauter Mülleimer
- Integrierter Papierrollenhalter
- 4 Räder mit hoher Tragkraft, Ø 150 mm, 2 feste und 2 drehbare mit Bremse
- Zentralverriegelung mit vorderem Schloss
- Bohrungen zum Einbringen eines Schraubstocks (Art. 1599P/150, separat zu bestellen)

📦 122 kg

C45PRO MWS/W € 1.930,00 1 045000191



h	max
65 mm	25 kg
105 mm	40 kg
145 mm	30 kg

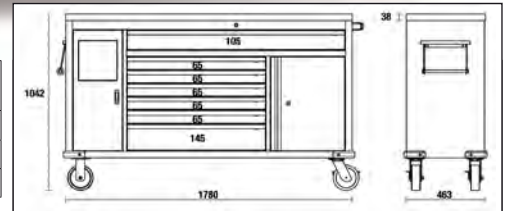

C45PRO CPF

Werkzeuglochplatten, Paar, für Werkzeugwagen C45PRO MWS

Geliefert komplett mit Trägerstruktur
Satz 50 GPS-Haken inbegriffen

📦 21 kg

C45PRO CPF € 257,00 1 045000195



C45PX/1-0,7MT

Arbeitsplatte aus MDF mit rostfreier Stahlbeschichtung, 680x463 mm, für Werkbank Werkstatteinrichtung C45PRO

- Stärke: 38 mm
- Bohrungen zum Einbringen eines Schraubstocks (Art. 1599P/150, separat zu bestellen)

📦 6 kg

C45PX/1-0,7MT € 241,00 1 045000101



C45PW/1-0,7MT

Multiplex-Arbeitsplatte, 680x463 mm, für Werkbank Werkstatteinrichtung C45PRO

- Stärke: 38 mm
- Bohrungen zum Einbringen eines Schraubstocks (Art. 1599P/150, separat zu bestellen)

📦 6 kg

C45PW/1-0,7MT € 142,00 1 045000111



C45PX/2-1,3MT

Arbeitsplatte aus MDF mit rostfreier Stahlbeschichtung, 1360x463 mm, für Werkbank Werkstatteinrichtung C45PRO

- Stärke: 38 mm
- Bohrungen zum Einbringen eines Schraubstocks (Art. 1599P/150, separat zu bestellen)

21 kg

C45PX/2-1,3MT € 384,00 1 045000103



C45PW/2-1,3MT

Multiplex-Arbeitsplatte, 1360x463 mm, für Werkbank Werkstatteinrichtung C45PRO

- Stärke: 38 mm
- Bohrungen zum Einbringen eines Schraubstocks (Art. 1599P/150, separat zu bestellen)

20 kg

C45PW/2-1,3MT € 245,00 1 045000113



C45PX/3-2,0MT

Arbeitsplatte aus MDF mit rostfreier Stahlbeschichtung, 2040x463 mm, für Werkbank Werkstatteinrichtung C45PRO

- Stärke: 38 mm
- Bohrungen zum Einbringen eines Schraubstocks (Art. 1599P/150, separat zu bestellen)

31,8 kg

C45PX/3-2,0MT € 515,00 1 045000110



C45PW/3-2,0MT

Multiplex-Arbeitsplatte, 2040x463 mm, für Werkbank Werkstatteinrichtung C45PRO

- Stärke: 38 mm
- Bohrungen zum Einbringen eines Schraubstocks (Art. 1599P/150, separat zu bestellen)

30 kg

C45PW/3-2,0MT € 367,00 1 045000120



C45PRO C5

Werkzeugwagen mit 5 Schubladen für Werkstatteinrichtung C45PRO

- 5 Schubladen mit Teleskopführungen, kugelgelagert, 532x406 mm
- 4 Lenkräder, Ø 100 mm (davon 1 gebremst)
- Schubladenböden mit Schaumgummibelag
- Zentralverriegelung mit vorderem Schloss
- Ausgelegt zum Einfügen von Thermoformateinsätzen
- In die Struktur integrierte Griffe für ein einfaches Handling

46 kg

C45PRO C5 € 898,00 1 045000225

h	max
65 mm	25 kg
145 mm	30 kg

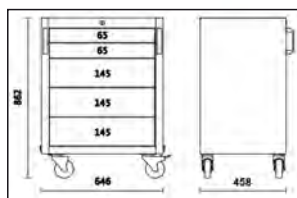
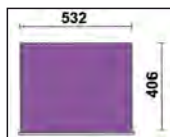

C45PRO C7



Werkzeugwagen mit 7 Schubladen für Werkstatteinrichtung C45PRO

- 7 Schubladen mit Teleskopführungen, kugelgelagert, 532x406 mm
- 4 Lenkräder Ø 100 mm (davon 2 gebremst)
- Schubladenböden mit Schaumgummibelag
- Zentralverriegelung mit vorderem Schloss
- Ausgelegt zum Einfügen von Thermoformateinsätzen
- In die Struktur integrierte Griffe für ein einfaches Handling

50 kg

C45PRO C7

€ 940,00 1 045000227

	
65 mm	25 kg
145 mm	30 kg

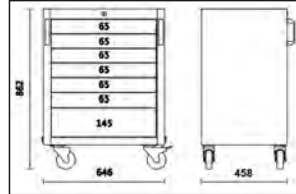
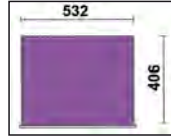

C45PRO M4



Festes Modul mit 4 Schubladen für Werkstatteinrichtung C45PRO

- 4 Schubladen mit Teleskopführungen, kugelgelagert, 566x406 mm
- Schubladenböden mit Schaumgummibelag
- Zentralverriegelung mit vorderem Schloss
- Mit höhenverstellbaren Füßen
- Ausgelegt zum Einfügen von Thermoformateinsätzen

45,7 kg

C45PRO M4

€ 771,00 1 045000234

	
65 mm	25 kg
145 mm	30 kg
225 mm	30 kg

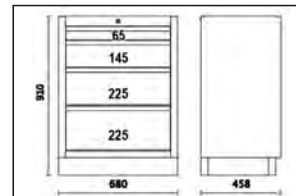
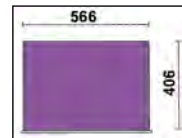

C45PRO M5



Festes Modul mit 5 Schubladen für Werkstatteinrichtung C45PRO

- 5 Schubladen mit Teleskopführungen, kugelgelagert, 566x406 mm
- Schubladenböden mit Schaumgummibelag
- Zentralverriegelung mit vorderem Schloss
- Mit höhenverstellbaren Füßen
- Ausgelegt zum Einfügen von Thermoformateinsätzen

49,3 kg

C45PRO M5

€ 870,00 1 045000235

	
65 mm	25 kg
145 mm	30 kg

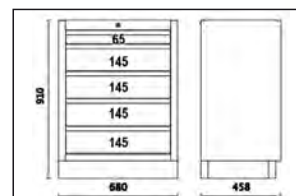



C45PRO M7

Festes Modul mit 7 Schubladen für Werkstatteinrichtung C45PRO

- 7 Schubladen mit Teleskopführungen, kugelgelagert, 566x406 mm
- Schubladenböden mit Schaumgummibelag
- Zentralverriegelung mit vorderem Schloss
- Mit höhenverstellbaren Füßen
- Ausgelegt zum Einfügen von Thermoformateinsätzen

📦 54,3 kg

	
65 mm	25 kg
145 mm	30 kg

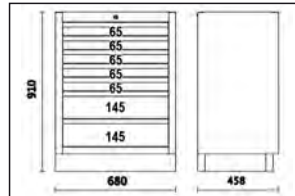
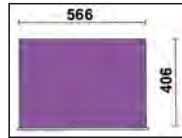



C45PRO M7 € 905,00 1 045000237

C45PRO M8

Feststehendes Modul mit 8 Schubladen für Werkstatteinrichtung C45PRO

- 8 Schubladen mit Teleskopführungen, kugelgelagert, 566x406 mm
- Schubladenböden mit Schaumgummibelag
- Zentralverriegelung mit vorderem Schloss
- Mit höhenverstellbaren Füßen
- Ausgelegt zum Einfügen von Thermoformateinsätzen

📦 56,5 kg

	
65 mm	25 kg
145 mm	30 kg

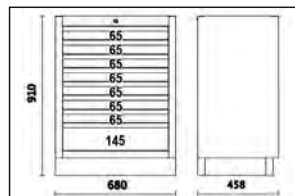

C45PRO M8 € 984,00 1 045000238

C45PRO MS

Festes Servicemodul für Werkstatteinrichtung C45PRO

- Eingebauter Mülleimer
- Papierrollenfach, für vorgelochte Rollen
- Mit höhenverstellbaren Füßen

📦 37 kg

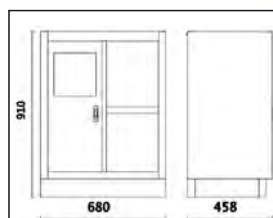

C45PRO MS € 615,00 1 045000239

C45PRO RD/X

Feststehendes Modul für Trennmüll für Werkstatteinrichtung C45PRO

Die ideale Lösung für Trennmüll (Glas, Papier, Kunststoff...)

- Arbeitsplatte aus MDF mit rostfreier Stahlbeschichtung, 1360 mm
- Robuster Blechrahmen komplett mit 4 Behältern mit Schwingtür für Mülltrennung
- Jeder Behälter ist ausgestattet mit:
 - 1 ausziehbarem Mülleimer aus Kunststoff, Kapazität 25 l
 - 4 Lenkrädern, Ø 60 mm
- Kit 4 farbige Aufkleber, im Lieferumfang inbegriffen
- Mit höhenverstellbaren Füßen

80 kg

C45PRO RD/X	€	1	045000241
C45PRO RD/W	1.900,00	1	045000240
	1.780,00	1	045000240



C45PRO RD/X



C45PRO RD/W

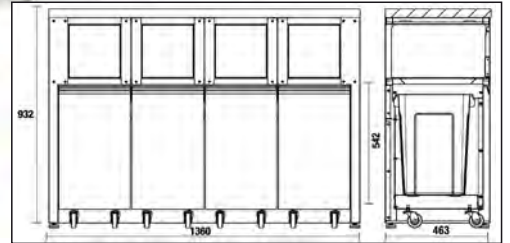

C45PRO MA

Festes Modul, 2-türig, für Werkstatteinrichtung C45PRO

- Mit Schloss
- Höhenverstellbare interne Ablage
- Innenabmessungen: 670x420 mm
- Mit höhenverstellbaren Füßen

29,4 kg

C45PRO MA	€	1	045000232
	457,00	1	045000232

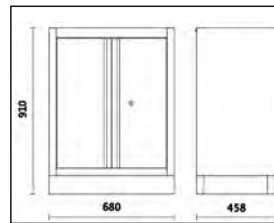

C45PRO MAL

Festes Modul, 1360 mm, 2-türig, für Werkstatteinrichtung C45PRO

- Mit Schloss
- Höhenverstellbare interne Ablage
- Innenabmessungen: 670x420 mm
- Mit höhenverstellbaren Füßen

44,8 kg

C45PRO MAL	€	1	045000229
	805,00	1	045000229

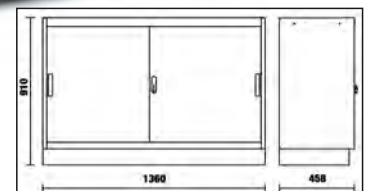

C45PRO MAT

Festes Modul, 1360 mm, mit 2 Türen aus durchsichtigem Polycarbonat, für Werkstatteinrichtung C45PRO

- Mit Schloss
- Höhenverstellbare interne Ablage
- Innenabmessungen: 670x420 mm
- Mit höhenverstellbaren Füßen

📦 44,1 kg

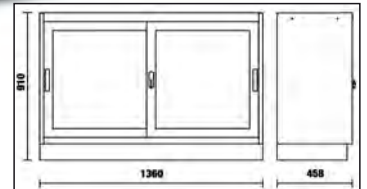

C45PRO MAT

€ 883,00 1 045000230

C45PRO M3A

Feststehendes Modul mit 3 Schubladen und 2 Türen für Werkstatteinrichtung C45PRO

- 3 Schubladen mit Teleskopführungen, kugelgelagert, 566x406 mm
- Schubladenböden mit Schaumgummibelag
- Ausgelegt zum Einfügen von Thermoformateinsätzen
- Zentralverriegelung mit vorderem Schloss
- Aufbewahrungsfach mit doppelter Tür und Schloss (Innenabmessungen 670x440 mm), mit Zwischenboden
- Mit höhenverstellbaren Füßen

📦 44 kg

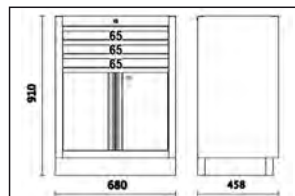
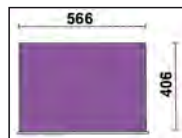

C45PRO M3A

€ 788,00 1 045000231

C45PRO ML

Festes Modul mit integriertem Waschbecken für Werkstatteinrichtung C45PRO

Technische Eigenschaften:

- Becken aus rostfreiem Stahl.
- Ausstattung:
 - 1 Mischhahn
 - 1 Ablaufgarnitur
 - 1 Verschlussdeckel
 - 1 Filterdeckel
 - 1 Seifenspender

Festes Modul, 2-türig, mit Schloss:

- Innere Nutzabmessungen: 600x603x416 mm
- Mit höhenverstellbaren Füßen

📦 44 kg

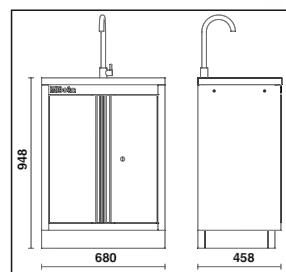

C45PRO ML

€ 1.240,00 1 045000233

C45PRO ACT

Festes Modul mit 3 Schubladen und 2 integrierten Aufrollern für Werkstatteinrichtung C45PRO

- 3 Schubladen mit Teleskopführungen, kugellagert, 566x406 mm
- Schubladenböden mit Schaumgummibelag
- Zentralverriegelung mit vorderem Schloss
- Mit höhenverstellbaren Füßen

Ausstattung:

- 1 integrierter Schlauchaufroller für Druckluft oder Kaltwasser, Ø 8 mm, Länge 10 m, Art. 1900S 8x10
- 1 integrierter Kabelaufroller, Länge 15 m, Art. 1844 15-H05

47 kg

C45PRO ACT

€ 1.220,00 1 045000247



65 mm	25 kg
145 mm	30 kg

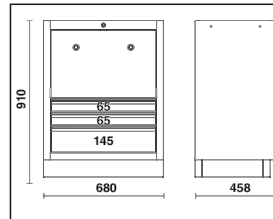

C45PRO TC

Feststehendes Modul für Aufroller mit 3 Schubladen für Werkstatteinrichtung C45PRO, leer

- 3 Schubladen mit Teleskopführungen, kugellagert, 566x406 mm
- Schubladenböden mit Schaumgummibelag
- Zentralverriegelung mit vorderem Schloss
- Mit höhenverstellbaren Füßen

- Ausgelegt für das Einfügen von 2 der folgenden Aufroller:
 - 2 Schlauchaufroller für Druckluft oder Kaltwasser, ø 8 mm, Länge 10 m Art. 1900S 8x10
 - 2 Kabelaufroller Ihrer Wahl aus folgenden Artikeln: 1843 15-H05, 1844 10-H05, 1844 15-H05, 1844 15-H07, 1845 12-H05, 1846 10-H05, 1846 10-H07 und 1846 15-H05
 - 1 Schlauchaufroller für Druckluft oder Kaltwasser, ø 8 mm, Länge 10 m Art. 1900S 8x10 und 1 Kabelaufroller Ihrer Wahl aus den oben aufgeführten Artikeln

38 kg

C45PRO TC

€ 717,00 1 045000249

65 mm	25 kg
145 mm	30 kg

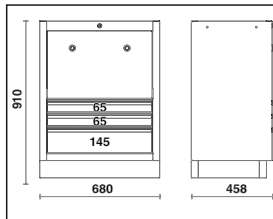
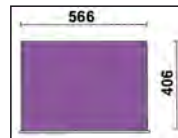

C45PRO T3

Werkzeugwagen mit 3 Einlegeböden für Werkstatteinrichtung C45PRO

- Doppelte Befestigungsmöglichkeit des mittleren Einlegebodens
- 4 Lenkräder, Ø 100 mm (davon 1 gebremst)
- Statische Belastung: 200 kg (gleichmäßig auf die 3 Einlegeböden verteilt)

19,2 kg

C45PRO T3

€ 358,00 1 045000250

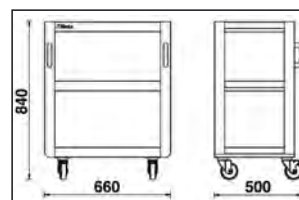

C45PRO SS

Seitenbügel für Wand, schmaler Typ, für Werkstatteinrichtung C45PRO

• Abmessungen: 1420x32,5x30 mm

1,5 kg

C45PRO SS € 35,50 1 045000333



C45PRO SL

Seitenbügel für Wand, breiter Typ, für Werkstatteinrichtung C45PRO

• Abmessungen: 1420x65x30 mm

2 kg

C45PRO SL € 46,50 1 045000366



C45PRO PAS

Werkzeugwand für Werkstatteinrichtung C45PRO

- Aluminiumrollladen, vertikal manövrierbar, mit Schloss
- 2 Werkzeuglochplatten, abnehmbar
- Kombinierbar mit der 1,3-m-langen Werkbank

48,8 kg

C45PRO PAS € 1.160,00 1 045000290

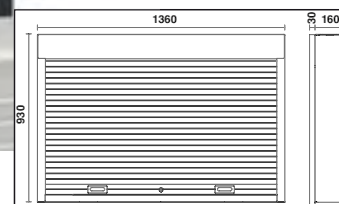

C45PRO PF

Werkzeuglochplatte für Werkstatteinrichtung C45PRO

• Abmessungen: 1052x614,5x24 mm

5,3 kg

C45PRO PF € 144,00 1 045000313



C45PRO PFE

Werkzeuglochplatte für Werkstatteinrichtung C45PRO

- Abmessungen: 1052x614,5x24 mm
- Ausgelegt für das Anbringen einer Steckdose (im Lieferumfang nicht enthalten)

5,3 kg



C45PRO PFE € 137,00 1 045000312



C45PRO MP

Stahlregal für Werkzeuglochplatten für Werkstatteinrichtung C45PRO

Abmessungen: 614x160x80 mm

1,8 kg

C45PRO MP € 62,00 1 045000315



C45PRO CORNER/X

Komplettecke, selbsttragend, für Werkstatteinrichtung C45PRO

- Eckhängeschrank mit Gasdruckfedern zur einfacheren Öffnung und Schließung der Tür, mit Schloss
- 2 Werkzeuglochplatten, 1052x860 mm
- Eckarbeitsplatte aus rostfreiem Stahl, 860 x 860 mm
- Unteres Eckmodul mit geräumigem Aufbewahrungs- und Ablageflach
- Mit höhenverstellbaren Füßen

94 kg

C45PRO CORNER/X € 2.340,00 1 045000401



 **Beta**

C45PRO CORNER/W

Komplettecke, selbsttragend, für Werkstatteinrichtung C45PRO

- Eckhängeschrank mit Gasdruckfedern zur einfacheren Öffnung und Schließung der Tür, mit Schloss
- 2 Werkzeuglochplatten, 1052x860 mm
- Multiplex-Eckarbeitsplatte, 860 x 860 mm
- Unteres Eckmodul mit geräumigem Aufbewahrungs- und Ablagefach
- Mit höhenverstellbaren Füßen

93 kg

C45PRO CORNER/W € 2.260,00 1 045000411

C45PRO CAI/X

Unteres Eckmodul für Werkstatteinrichtung C45PRO

- Eckarbeitsplatte aus MDF mit rostfreier Stahlbeschichtung, 860x860 mm
- Feststehendes Eckmodul mit geräumigem Aufbewahrungs- und Ablagefach
- Mit höhenverstellbaren Füßen

62 kg

C45PRO CAI/X € 1.285,00 1 045000412

C45PRO CAI/W

Unteres Eckmodul für Werkstatteinrichtung C45PRO

- Multiplex-Eckarbeitsplatte, 860x860 mm
- Feststehendes Eckmodul mit geräumigem Aufbewahrungs- und Ablagefach
- Mit höhenverstellbaren Füßen

56 kg

C45PRO CAI/W € 1.200,00 1 045000402

C45PRO PM

Wandhängeschrank für Werkstatteinrichtung C45PRO

- Länge Wandhängeschrank 680 mm
- Mit Gasdruckfedern zur einfacheren Öffnung und Schließung der Tür
- Mit Schloss

10 kg

C45PRO PM € 264,00 1 045000302

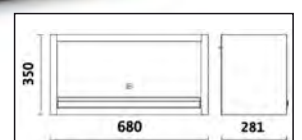
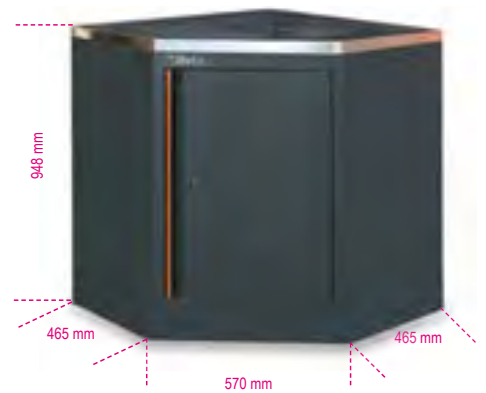

SSPE

Unterschrankhalterung für Elektrowerkzeuge

- Kann nur unter dem Hängeschrank C45PRO PM (Möbelserie C45PRO) montiert werden
- Mit 5 praktischen Fächern zur Unterbringung von Elektrowerkzeugen
- Abmessungen: 680 x 280 x 150 mm

📦 5,4 kg



SSPE

€ 111,00 1 088880482

C45PRO PML

Wandhängeschrank, lang, für Werkstatteinrichtung C45PRO

- Länge Wandhängeschrank, 1360 mm
- Mit Gasdruckfedern zur einfacheren Öffnung und Schließung der Tür
- Mit Schloss

📦 18 kg

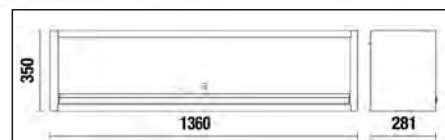

C45PRO PML

€ 472,00 1 045000303

C45PRO AS1

Blechschränk, 1-türig, mit Bügel, für Werkstatteinrichtung C45PRO

- 4 abnehmbare höhenverstellbare Ablagen
- Praktische klappbare Kleiderstange unter dem ersten Fachboden
- Mit Schloss
- Innenabmessungen: 590x430 mm
- Mit höhenverstellbaren Füßen

📦 57,5 kg

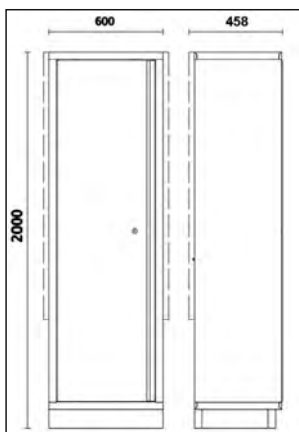

C45PRO AS1

€ 940,00 1 045000451

C45PRO A1/R600

Innerer Einlegeboden für Schrank C45PRO AS1

📦 2,5 kg



C45PRO A1/R600

€ 57,00 1 045000466

C45PRO A1/RB600

Innerer Einlegeboden für Schrank C45PRO AS1 mit Kleiderstange

2,6 kg

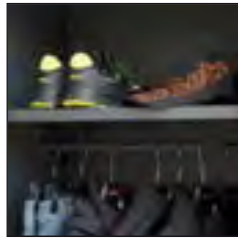

C45PRO A1/RB600 € 66,00 1 045000467

C45PRO AS2

Blechschränk, 2-türig, mit Bügel für Werkstatteinrichtung C45PRO

- 4 abnehmbare höhenverstellbare Ablagen
- Mit Schloss
- Innenabmessungen: 910x430 mm
- Mit höhenverstellbaren Füßen

80 kg

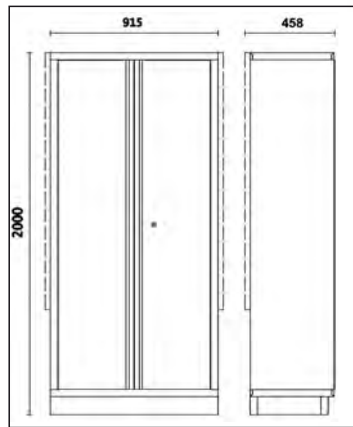

C45PRO AS2 € 1.250,00 1 045000481

C45PRO A2/R915

3,7 kg



C45PROA2/R915 € 71,00 1 045000496

C45STR







Farbiges Klebeband für Werkstatteinrichtung C45PRO

- Ermöglicht, die waagerechten und senkrechten Einsätze der Werkstatteinrichtung C45PRO mit Farbe individuell zu gestalten

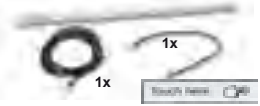
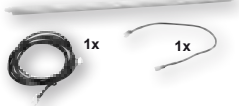

	L m	€		
C45STR-O/2011	30	74,00	1	045000911
C45STR-G/9006	25	67,00	1	045000912
C45STR-R/3000	25	67,00	1	045000913
C45STR-B/5015	25	67,00	1	045000914
C45STR-Y/1023	25	67,00	1	045000915
C45STR-V/6029	25	67,00	1	045000916

ZUBEHÖR RSC55 - RSC50 - C45PRO

		5000 RSC50/PLED-ST	5000 RSC50/PLED	5000 RSC50/ASL	5000 RSC50/CTR
					
	A	1x	-	1x	-
	B	-	1x	1x	1x
	A	1x	1x	1x	-
	B	-	2x	1x	1x
	A	1x	2x	1x	-
	B	-	3x	1x	1x

5000 RSC50/PLED

Aluminiumprofil mit LED-Leiste, für Werkstattausrüstung Kombination RSC50

Anzuwenden unter Arbeitsplatten, unter/in Hängeschränken, unter Regalen und linearen/eckigen Schutzvorrichtungen, in leichten Arbeitsbereichen.

Eigenschaften:

- 6.5 W IP20 LED-Leiste; Länge: 50 cm
- Lieferung komplett mit 2 Kabeln (40 cm bzw. 170 cm lang) - Bequeme Befestigung durch Magnete



80 g

5000 RSC50/PLED

€ 42,00 1 050001714

5000 RSC50/PLED-ST

Aluminiumprofil mit LED-Leiste und SOFT TOUCH-Schalter, für Werkstattausrüstungskombination RSC50

Anzuwenden unter Arbeitsplatten, unter/in Hängeschränken, unter Regalen und linearen/eckigen Schutzvorrichtungen, in leichten Arbeitsbereichen.

Eigenschaften:

- 6.5 W IP20 LED-Leiste; Länge: 50 cm
- SOFT TOUCH-Schalter zum Einschalten und Einstellen der Lichtleistung
- Lieferung komplett mit zwei Kabeln (40 cm bzw. 170 cm lang)
- Bequeme Befestigung durch Magnete

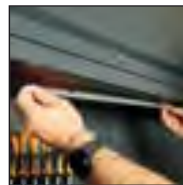

80 g

5000 RSC50/PLED-ST

€ 46,50 1 050001715

5000 RSC50/ASL

Netzteil, für LED-Leiste für Werkstattausrüstung Kombination RSC50

Merkmale:

- 24VDC 22W Stromversorgung
- Kann bis zu 3 6.5W LED-Streifen mit Strom versorgen



200 g

5000 RSC50/ASL

€ 36,50 1 050001716

5000 RSC50/CTR

LED-Streifensteuerung, mit RF-Fernbedienung
für Werkstattausrüstungskombination RSC50

Nur zur Verwendung mit LED-Streifen Artikel 5000
RSC50/PLED

Inhalt des Kits:
1 Mini-Empfänger
1 drahtlose RF-Fernbedienung

Spezifikationen des Mini-Empfängers:

Eingangsspannung: 5V -24VDC

Nennausgangsstrom: 5A

Spitzenausgangsstrom: 12A

Betriebstemperatur: -20 ÷ +35 °C

Technische Daten der RF-Fernbedienung:

ON/OFF-Taste

BRIGHT +/- Taste: ermöglicht die manuelle
Einstellung der Lichtleistung

Taste 25%/50%/100%: ermöglicht die automatische
Einstellung der Beleuchtungsstärke

Batterie: 3V CR2025 (mitgeliefert)

Abmessungen: 86x40x7 mm

Integrierte Funktionen:

- Speicher
- Modus (manuelle/automatische Helligkeit)
- Einstellung der Helligkeit



20 g

5000 RSC50/CTR

€ 18,10 1 050001721

CPMB/3C

Kleinteilbehälter mit 3 Schubladen für Werkbank

- Außenstruktur aus PP
- Schubladen aus PET
- Stapelbar

Technische Merkmale der Schubladen:

- Innenmaße der Schublade 160 x 107 x 105 h mm
- Unzerbrechlich
- Unvergängliche Transparenz mit Glaseffekt
- Kratzbeständig
- Beständig gegen Öle, Säuren und aggressive Chemikalien
- Auch für den Einsatz in Lebensmittelumgebungen geeignet

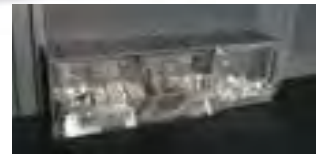

2 kg

CPMB/3C

€ 60,00 1 088880443

KIT 6VC/3C

Satz mit 6 ausziehbaren Wannen für Kleinteilbehälter Art. CPMB/3C

1,1 kg



6x

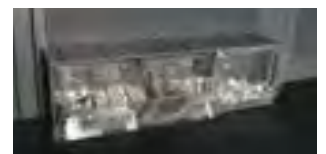

KIT 6VC/3C

€ 33,00 1 088880453

CPMB/5C

Kleinteilbehälter mit 5 Schubladen für Werkbank

- Außenstruktur aus PP
- Schubladen aus PET
- Stapelbar

Technische Merkmale der Schubladen:

- Innenmaße der Schublade 90 x 86 x 62 h mm
- Unzerbrechlich
- Unvergängliche Transparenz mit Glaseffekt
- Kratzbeständig
- Beständig gegen Öle, Säuren und aggressive Chemikalien
- Auch für den Einsatz in Lebensmittelumgebungen geeignet



1,5 kg

CPMB/5C

€ 71,50 1 088880445

KIT 10VC/5C

Satz mit 10 ausziehbaren Wannen für Kleinteilbehälter Art. CPMB/5C

800 g

KIT 10VC/5C

€ 30,50 1 088880455



10x



PM/5C

Kleinteileaufnahme mit 5 Schalen aus Kunststoffmaterial, mit Halterung, für Wandmontage

- Innenabmessungen der Schale: 95x120 mm
- Kombinierbar mit Werkzeugwänden C45PRO und RSC55

1,8 kg

PM/5C

€ 126,00 1 088880450

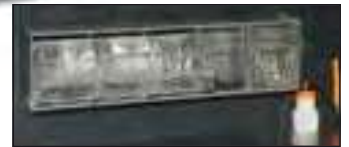

PM/6C

Kleinteileaufnahme mit 6 Schalen aus Kunststoffmaterial, mit Halterung, für Wandmontage

- Innenabmessungen der Schale: 80x60 mm
- Kombinierbar mit Werkzeugwänden C45PRO und RSC55

970 g

PM/6C

€ 96,50 1 088880440



CP

Flaschenträger aus Stahl für Wandbefestigung

- Kombinierbar mit Werkzeugtafeln für Wandbefestigung

530 g

CP

€ 122,00 1 088880470

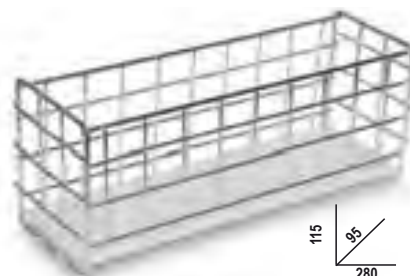

SPC

Computer-Wandhalter

- Kombinierbar mit Werkzeugwänden Art. RSC55 und Art. C45PRO
- Abmessungen 398x243x138 mm

1,5 kg



SPC

€ 98,50 1 088880480

SP5S

Wandhalterung mit 5 Fächern

- Aus Metallblech
- 5 Werkzeugfächer mit unterschiedlichen Höhen
- Abmessungen: 260x60x290 mm

1 kg



SP5S

€ 122,00 1 088880475



Beta

WERKSTATTEINRICHTUNGEN

LOSE WERKZEUGE

THERMOFORMEINSÄTZEN

			Stück	WERKSTATTEINRICHTUNGEN															
				RSC22	RSC23	RSC23C	RSC23T	RSC24/5	RSC24/6	RSC24/7	RSC24A/7	RSC24/8	RSC24A/8	RSC24AXL/9	C25	C27S	RSC28	C30M	
ohne Halterungen	5902MT	Erdbewegung	106	☐ 518	☐ 518	☐ 518													
	5902MT/AS	Erdbewegung	99	☐ 519	☐ 519	☐ 519													
	5902VI	Industriewartung	107	☐ 481	☐ 481		☐ 481							☐ 481	☐ 481				
	5904VG/3	KFZ-Mechanik	132					☐ 522	☐ 522	☐ 522	☐ 522								
	5905VG/1	KFZ-Mechanik	94											☐ 525					
	5905VG/2	KFZ-Mechanik	118											☐ 526					
	5910VI/3	Industriewartung	297																☐ 485
	5954VG	KFZ-Mechanik	138																
	5954VI	Industriewartung	133																
	5957U-P	Universalsortimente	133																
5957VG	KFZ-Mechanik	174																	
5957VI	Industriewartung	162																	
5958U	Universalsortimente	85																	
mit Halterungen	5904VG/2M	KFZ-Mechanik	170				☐ 520	☐ 520	☐ 520	☐ 520	☐ 520	☐ 520						☐ 520	
	5904VU/1M	Universalsortimente	90				☐ 490	☐ 490	☐ 490	☐ 490	☐ 490	☐ 490						☐ 490	
	5904VU/2M	Universalsortimente	144				☐ 491	☐ 491	☐ 491	☐ 491	☐ 491	☐ 491						☐ 491	
	5927VU/M	Universalsortimente	108	☐ 501	☐ 501	☐ 501										☐ 501			
	5935ET/1MB	Elektrotechnik	96																
	5935VG/1MB	KFZ-Mechanik	98																
	5935VI/2MB	Industriewartung	133																
	5945VUM	Universalsortimente	231																
	5988H/7M	KFZ-Mechanik	333									☐ 508	☐ 508					☐ 508	
	5988L/4M	KFZ-Mechanik	273				☐ 509	☐ 509	☐ 509	☐ 509	☐ 509	☐ 509	☐ 509						
	5980U/BIKE-M	Fahrradreparaturen	106									☐ 507	☐ 507					☐ 507	
	5988U6/M	Universalsortimente	214								☐ 510	☐ 510	☐ 510					☐ 510	
	5988U/7M	Universalsortimente	215				☐ 497	☐ 497	☐ 497	☐ 497	☐ 497	☐ 497	☐ 497					☐ 497	
	5988VHB-MQ	Elektrotechnik	66				☐ 514	☐ 514	☐ 514	☐ 514	☐ 514	☐ 514	☐ 514					☐ 514	
	5989 VEM	KFZ-Mechanik	66				☐ 517	☐ 517	☐ 517	☐ 517	☐ 517	☐ 517	☐ 517					☐ 517	
	5904VI/1T	Industriewartung	98				☐ 481	☐ 481	☐ 481	☐ 481	☐ 481	☐ 481	☐ 481					☐ 481	
	5904VI/2T	Industriewartung	153				☐ 482			☐ 482	☐ 482	☐ 482	☐ 482					☐ 482	
	5904VI/3T	Industriewartung	142									☐ 483	☐ 483					☐ 483	
	5904VG/2T	KFZ-Mechanik	99				☐ 521	☐ 521	☐ 521	☐ 521	☐ 521	☐ 521	☐ 521					☐ 521	
5904VG/3T	KFZ-Mechanik	102				☐ 523	☐ 523	☐ 523	☐ 523	☐ 523	☐ 523	☐ 523					☐ 523		
5904VG/5T	KFZ-Mechanik	153				☐ 524		☐ 524	☐ 524	☐ 524	☐ 524	☐ 524					☐ 524		
5904VU/2T	Universalsortimente	104				☐ 492	☐ 492	☐ 492	☐ 492	☐ 492	☐ 492	☐ 492					☐ 492		
5904VU/3T	Universalsortimente	146				☐ 493	☐ 493	☐ 493	☐ 493	☐ 493	☐ 493	☐ 493					☐ 493		
5904VU/4T	Universalsortimente	197				☐ 494	☐ 494	☐ 494	☐ 494	☐ 494	☐ 494	☐ 494							
5908VG/2T	KFZ-Mechanik	214																☐ 527	
5908VI/2T	Industriewartung	232									☐ 484	☐ 484					☐ 484		
5908VU/2T	Universalsortimente	161				☐ 495		☐ 495	☐ 495	☐ 495	☐ 495	☐ 495					☐ 495		
5910VI/3T	Industriewartung	261																☐ 486	
5938U/2T	Universalsortimente	210																	

WERKSTATTEINRICHTUNGEN

LOSE WERKZEUGE

THERMOFORMEINSÄTZEN

			Stück	C35	C38	C39MD C39SM	C39T	C45PRO	RSC51	C54S RSC55C	RSC55	RSC55PS RSC55PSE	RSC50	C57SA C57SD	C57SB C57SP	C57SC	C58P C45PRO PAS	C59A C59C	C59B	
ohne Halterungen	5902MT	Erdbewegung	106				▢ 518													
	5902MT/AS	Erdbewegung	99				▢ 519													
	5902VI	Industriewartung	107																	
	5904VG/3	KFZ-Mechanik	132								▢ 522		▢ 522					▢ 522	▢ 522	
	5905VG/1	KFZ-Mechanik	94																	
	5905VG/2	KFZ-Mechanik	118																	
	5910VI/3	Industriewartung	297																	
	5954VG	KFZ-Mechanik	138							▢ 531										
	5954VI	Industriewartung	133							▢ 489	▢ 489									
	5957U-P	Universalsortimente	133									▢ 503	▢ 503	▢ 503						
	5957VG	KFZ-Mechanik	174									▢ 532		▢ 532						
	5957VI	Industriewartung	162											▢ 488						
5958U	Universalsortimente	85					▢ 504			▢ 504	▢ 504				▢ 504					
mit Halterungen	5904VG/2M	KFZ-Mechanik	170			▢ 520	▢ 520				▢ 520							▢ 520	▢ 520	
	5904VU/1M	Universalsortimente	90			▢ 490	▢ 490		▢ 490	▢ 490								▢ 490	▢ 490	
	5904VU/2M	Universalsortimente	144			▢ 491	▢ 491			▢ 491								▢ 491	▢ 491	
	5927VU/M	Universalsortimente	108																	
	5935ET/1MB	Elektrotechnik	96	▢ 511																
	5935VG/1MB	KFZ-Mechanik	98	▢ 528																
	5935VI/2MB	Industriewartung	133	▢ 487																
	5945VUM	Universalsortimente	231		▢ 530			▢ 530												
	5988H/7M	KFZ-Mechanik	333								▢ 508								▢ 469	
	5988L/4M	KFZ-Mechanik	273			▢ 470	▢ 470				▢ 470							▢ 470	▢ 470	
	5980U/BIKE-M	Fahrradreparaturen	106																	
	5988U6/M	Universalsortimente	214			▢ 510					▢ 510								▢ 510	
	5988U/7M	Universalsortimente	215			▢ 497					▢ 497							▢ 497	▢ 497	
	5988VHB-MQ	Elektrotechnik	66			▢ 514	▢ 514		▢ 514	▢ 514								▢ 514	▢ 514	
	5989 VEM	KFZ-Mechanik	66																	
	Thermoformateinsätzen	5904VI/1T	Industriewartung	98			▢ 481	▢ 481		▢ 481	▢ 481								▢ 481	▢ 481
		5904VI/2T	Industriewartung	153			▢ 482				▢ 482								▢ 482	▢ 482
5904VI/3T		Industriewartung	142			▢ 483				▢ 483								▢ 483		
5904VG/2T		KFZ-Mechanik	99			▢ 521	▢ 521		▢ 521	▢ 521								▢ 521	▢ 521	
5904VG/3T		KFZ-Mechanik	102			▢ 523	▢ 523			▢ 523								▢ 523	▢ 523	
5904VG/5T		KFZ-Mechanik	153			▢ 524				▢ 524								▢ 524	▢ 524	
5904VU/2T		Universalsortimente	104			▢ 492	▢ 492			▢ 492								▢ 492	▢ 492	
5904VU/3T		Universalsortimente	146			▢ 493	▢ 493			▢ 493								▢ 493	▢ 493	
5904VU/4T		Universalsortimente	197			▢ 494	▢ 494			▢ 494								▢ 494	▢ 494	
5908VG/2T		KFZ-Mechanik	214																	
5908VI/2T		Industriewartung	232																▢ 484	
5908VU/2T		Universalsortimente	161			▢ 495				▢ 495								▢ 495	▢ 495	
5910VI/3T		Industriewartung	261																	
5938U/2T		Universalsortimente	210		▢ 502															

5902VI Werkzeugsortiment, 107-teilig

► Industriewartung

Stück / Beschreibung

- 6 Splinttreiber Ø 2 - 3 - 4 - 5 - 6 - 8 mm
- 1 Körner Ø 3 mm
- 1 Flachmeißel, mit Hohlprofil 200 mm
- 26 Ring-Maulschlüssel 6÷32 mm
- 12 Doppelmaulschlüssel 6x7 - 8x9 - 10x11 - 12x13 - 14x15 - 16x17
18x19 - 20x22 - 21x23 - 24x26 - 25x28 - 30x32 mm
- 9 Sechskant-Stiftschlüssel, gebogen Ø 1,5 - 2 - 2,5 - 3 - 4 - 5 - 6 - 8 - 10 mm
- 1 Einmaulschlüssel, verstellbar 300 mm
- 13 Sechskant - Steckschlüssel, 1/2", mit Halter Ø 10÷22 mm
- 1 Verlängerung, 1/2" 125 mm
- 1 Verlängerung, 1/2" 255 mm
- 1 Kardangelenke, 1/2"
- 1 Gleitgriff, 1/2"
- 1 Umschaltknarre, 1/2" ®
- 1 Verstellbare Zangen 250 mm
- 1 Gripzange, verstellbar 240 mm
- 1 Diagonalseitenschneider für geringen Kraftaufwand, Griffe aus Bimaterial, Industrie-Finish 160 mm
- 1 Hebelzangenschere geradeschneidend 250 mm
- 1 Elektrikerschere, gerade Schneiden
- 1 Universalzangen für geringen Kraftaufwand, Griffe aus Bimaterial, Industrie-Finish 180 mm
- 1 Zangen mit halbrunden Backen, extralang, gerade, innengeriffelt, Griffe aus Bimaterial, Industrie-Finish 160 mm
- 8 Schraubendreher für Schlitzschrauben ● 2,5x50 - 3x75 - 3,5x100 - 4x125 - 5,5x125 - 6,5x150 - 8x200 - 10x200 mm
- 4 Schraubendreher für Phillips®-Schrauben ⊕ PH0x60 - PH1x80 - PH2x100 - PH3x150 mm
- 1 Schlosserhammer, deutsches Modell 500 g
- 1 rückschlagfreier Hammer Ø 40 mm
- 1 Reißnadel
- 1 Rollbandmaß 5 m
- 1 Fühlerlehre
- 5 Feilensatz, 5-teilig, halbschlicht, mit Griff 200 mm
- 1 Sägebogen
- 1 Metalllkanne mit Pumpe 300 cc
- 1 Cutter
- 1 Magnet-Gelenk-LED-Lampe LED leuchtstark, aus robustem eloxiertem Aluminium, bis zu 500 Lumen

Beta Nr.

- 31
- 32
- 35
- 42/S26
- 55/S12
- 96N/SC9
- 111E
- 920A/SB13
- 920/21
- 920/22
- 920/25
- 920/42
- 920/55
- 1048N
- 1052
- 1084GBM
- 1122
- 1128BMX
- 1150GBM
- 1166GBM
- 1260
- 1262
- 1370
- 1392
- 1688A
- 1692
- 1708/20
- 1719BMA...S5
- 1726BM
- 1751N
- 1771BM
- 1837F



€

5902VI 1.940,00 059021060

Sortiment empfohlen in Kombination mit RSC22 - RSC23 - RSC23T - C25 - C27S

5904VI/1T

Werkzeugsortiment, 98-teilig, im festen Thermoformateinsatz aus ABS

► Industriewartung

Stück / Beschreibung

- 19 Sechskant-Steckschlüssel, 1/2" ○ 10÷24 - 26 - 27 - 30 - 32 mm
- 5 Sechskant-Steckschlüssel mit Innenvierkantantrieb, 1/2" ○ 5 - 6 - 8 - 10 - 12 mm
- 1 Verlängerung, 1/2" 125 mm
- 1 Verlängerung, 1/2" 255 mm
- 1 Kardangelenke, 1/2"
- 1 Gleitgriff, 1/2"
- 1 Umschaltknarre, 1/2" ®
- 16 Ring-Maulschlüssel 6÷21 mm
- 5 Ring-Maulschlüssel 22-24-27-30-32 mm
- 1 Verstellbare Zangen 250 mm
- 1 Gripzange, verstellbar 240 mm
- 1 Diagonalseitenschneider für geringen Kraftaufwand 160 mm
- 1 Zange mit halbrunden Backen, extralang, gerade 180 mm
- 1 Zangen mit halbrunden Backen, gerade 160 mm
- 1 Zangen mit geraden Backen für Sicherungsringe mit Innenspannung ○ 180 mm
- 1 Zangen mit um 90° gebogenen Backen für Sicherungsringe mit Innenspannung ○ 170 mm
- 1 Zangen mit geraden Backen für Sicherungsringe mit Außenspannung ● 175 mm
- 1 Zangen mit um 90° gebogenen Backen für Sicherungsringe mit Außenspannung ● 175 mm
- 2 Flachmeißel, mit Hohlprofil 100 - 200 mm
- 5 Feilen für normale Bearbeitung 200 mm
- 1 Schlosserhammer, deutsches Modell 300 g
- 1 Hammer mit auswechselbaren Kunststoffaufsätzen Ø 35 mm
- 8 Doppelmaulschlüssel 6x7 - 8x9 - 10x11 - 12x13 - 14x15 - 16x17 - 18x19 - 20x22 mm
- 9 Sechskant-Stiftschlüssel, gebogen Ø 1,5 - 2 - 2,5 - 3 - 4 - 5 - 6 - 8 - 10 mm
- 4 Schraubendreher für Schlitzschrauben ● 3x75 - 4x100 - 5,5x150 - 6,5x150 mm
- 3 Schraubendreher für Phillips®-Schrauben ⊕ PH0x60 - PH1x80 - PH2x100 mm
- 6 Stiftschlüssel mit T-Griff, Sechskantprofil an drei Enden 2,5 - 3 - 4 - 5 - 6 - 8 mm

Beta Nr. TR

- 920A T80
- 920ME T80
- 920/21 T80
- 920/22 T80
- 920/25 T80
- 920/42 T80
- 920/55 T80
- 42 T05
- 42 T06
- 1048N T153
- 1052 T153
- 1084 T138
- 1150 T138
- 1166 T138
- 1032 T145
- 1034 T145
- 1036 T145
- 1038 T145
- 35 T234
- 1719BMA8/S5 T236
- 1370 T234
- 1390 T234
- 55 T33
- 96/SC9 T33
- 1260 T208
- 1262 T208
- 951 T68



€

5904VI/1T 1.760,00 059041161

Sortiment empfohlen in Kombination mit RSC51 - RSC23T - RSC24 - RSC24L/7 - RSC24L-CAB
RSC24A - RSC24AXL - RSC28 - C37 - C39 6 - 7 - 8 Schubladen - C39MD - C39SM - C39T - RSC50 - RSC55 - C59

5904VI/2T

Werkzeugsortiment, 153-teilig, im festen Thermoformateinsatz aus ABS

► Industriewartung

Stück / Beschreibung

- 16 Ring-Maulschlüssel 6+21 mm
- 5 Ring-Maulschlüssel 22 - 24 - 27 - 30 - 32 mm
- 5 Splinttreiber Ø 2 - 3 - 4 - 5 - 6 mm
- 1 Körner Ø 4 mm
- 12 Doppelmaulschlüssel 6x7 - 8x9 - 10x11 - 12x13 - 14x15 - 16x17
18x19 - 20x22 - 21x23 - 24x26 - 27x29 - 30x32 mm
- 9 Sechskant-Stiftschlüssel, gebogen ○ 1,5 - 2 - 2,5 - 3 - 4 - 5 - 6 - 8 - 10 mm
- 7 Doppelringschlüssel, tief gekröpft 6+29 mm
- 19 Sechskant-Steckschlüssel, 1/2" ○ 10+24 - 26 - 27 - 30 - 32 mm
- 1 Verlängerung, 1/2" 125 mm
- 1 Verlängerung, 1/2" 255 mm
- 1 Kardangelenke, 1/2"
- 1 Gleitgriff, 1/2"
- 1 Umschaltknarre, 1/2" ⊕
- 13 Sechskant-Steckschlüssel, 1/4" ○ 4+14 mm
- 6 Sechskant-Steckschlüssel 1/4" ○ 2,5+8 mm
- 1 Verlängerung, - 1/4" 50 mm
- 1 Verlängerung, - 1/4" 150 mm
- 1 Kardangelenke, 1/4"
- 1 Steckgriff, 1/4"
- 1 Gleitgriff, 1/4"
- 1 Umschaltknarre, 1/4" ⊕
- 9 Schraubendreher für Schlitzschrauben ● 3x75 - 3x100 - 4x100 - 4x150 - 5,5x100 - 5,5x150
- 6,5x150 - 8x150 - 10x200 mm
- 2 Schraubendreher für Schlitzschrauben, extrakurze Klinge ● 4x30 - 6,5x30 mm
- 7 Schraubendreher für Phillips®-Schrauben ⊕ PH0x60 - PH0x100 - PH1x80 - PH1x120 -
PH2x100 - PH2x150 - PH3x150 mm
- 2 Schraubendreher für Phillips® - Schrauben, extrakurze Klinge ⊕ PH1x30 - PH2x30 mm
- 1 Verstellbare Zangen 250 mm
- 1 Gripzange, verstellbar 240 mm
- 1 Diagonalseitenschneider für geringen Kraftaufwand ≤ 160 mm
- 1 Zangen mit halbrunden Backen, gerade ● 160 mm
- 1 Zange mit halbrunden Backen, extralang, gerade = 180 mm
- 1 Zangen mit geraden Backen für Sicherungsringe mit Innenspannung ○ 180 mm
- 1 Zangen mit um 90° gebogenen Backen für Sicherungsringe mit Innenspannung ○ 170 mm
- 1 Zangen mit geraden Backen für Sicherungsringe mit Außenspannung ● 175 mm
- 1 Zangen mit um 90° gebogenen Backen für Sicherungsringe mit Außenspannung ● 175 mm
- 6 Stiftschlüssel mit T-Griff, Sechskantprofil an drei Enden 2,5 - 3 - 4 - 5 - 6 - 8 mm
- 5 Feilen für normale Bearbeitung 200 mm
- 2 Flachmeißel, mit Hohlprofil 100 - 200 mm
- 1 Schlosserhammer, deutsches Modell 300 g
- 1 Hammer mit auswechselbaren Kunststoffaufsätzen Ø 35 mm
- 1 Nietzange
- 100 Aluminiumnieten 2,9x6 mm
- 100 Aluminiumnieten 3,2x8 mm
- 100 Aluminiumnieten 3,8x10 mm
- 100 Aluminiumnieten 4x12 mm
- 100 Aluminiumnieten 4,8x12 mm
- 1 Rollbandmaß
- 1 Minisägebogen
- 1 Abbrechbare Klingen, 18 mm breit, 10 Stück, für Cutter Art. 1771, 1771BM, 1771HD
- 1 Cutter

Beta Nr.	TR
42	T05
42	T06
31	T31
32	T31
55	T31
96N/SC9	T31
90	T40
920A	T83
920/21	T83
920/22	T83
920/25	T83
920/42	T83
920/55	T83
900	T91
900ME	T91
900/20	T91
900/21	T91
900/25	T91
900BG/30	T91
900/42	T91
900/55	T91
1260	T167
1260N	T167
1262	T168
1262N	T168
1048N	T153
1052	T153
1084	T138
1166	T138
1150	T138
1032	T145
1034	T145
1036	T145
1038	T145
951	T68
1719BMA8/S5	T236
35	T234
1370	T234
1390	T234
1741B	T281
1741RV..K	T281
1741RV..K	T281
1741RV..K	T281
1741RV..K	T281
1741RV..K	T281
1692	T294
1725CR	T294
1771RL	T294
1771	T294



T05 T06 T31



T40 T83 T91



T167 T168



T153 T138 T145 T68



T236 T234 T281 T294



5904VI/2T 2.495,00 059041164

Sortiment empfohlen in Kombination mit RSC23T - RSC24 mit 7 - 8 Schubladen - RSC24A mit 7 - 8 Schubladen - RSC24AXL - RSC24L/7 - RSC24L-CAB - RSC28 C37 mit 7 - 8 Schubladen - C39 mit 7 - 8 Schubladen - C39MD - C39SM - C59 - RSC50 - RSC55

5904VI/3T

Werkzeugsortiment, 142-teilig, im festen Thermoformateinsatz aus ABS

► Industriewartung

Stück / Beschreibung

- 16 Ring-Maulschlüssel 6+21 mm
- 5 Ring-Maulschlüssel 22 - 24 - 27 - 30 - 32 mm
- 5 Splinttreiber Ø 2 - 3 - 4 - 5 - 6 mm
- 1 Körner Ø 4 mm
- 12 Doppelmaulschlüssel 6x7 - 8x9 - 10x11 - 12x13 - 14x15 - 16x17
18x19 - 20x22 - 21x23 - 24x26 - 27x29 - 30x32 mm
- 9 Sechskant-Stiftschlüssel, gebogen ○ 1,5 - 2 - 2,5 - 3 - 4 - 5 - 6 - 8 - 10 mm
- 9 Schraubendreher für Schlitzschrauben ● 3x75 - 3,5x100 - 4x100 - 4x150 - 5,5x100 - 5,5x150
- 6,5x150 - 8x150 - 10x200 mm
- 2 Schraubendreher für Schlitzschrauben, extrakurze Klinge ● 4x30 - 6,5x30 mm
- 6 Schraubendreher für Phillips®-Schrauben ● PH0x60 - PH0x100 - PH1x80 - PH1x120 -
PH2x100 - PH2x150 mm
- 7 Stiftschlüssel für Torx®-Schrauben ○ T6-T7-T8-T9-T10-T15-T20
- 5 Sechskant-Steckschlüssel mit Innenvierkantantrieb, 1/2" ○ 5 - 6 - 8 - 10 - 12 mm
- 1 Verlängerung, 1/2" 125 mm
- 1 Verlängerung, 1/2" 255 mm
- 1 Kardangelenke, 1/2"
- 1 Gleitgriff, 1/2"
- 1 Umschaltknarre, 1/2" ⊕
- 19 Sechskant-Steckschlüssel, 1/2" ○ 10+24 - 26 - 27 - 30 - 32 mm
- 8 Doppelsteckschlüssel, Zwölfkant-Köpfe 6x7 - 8x9 - 10x11 - 12x13 - 14x15 - 16x17
18x19 - 20x22 mm
- 1 Drehstifte für Doppelsteckschlüssel
- 1 Drehstifte für Doppelsteckschlüssel
- 6 Stiftschlüssel mit T-Griff, Sechskantprofil an drei Enden 2,5 - 3 - 4 - 5 - 6 - 8 mm
- 1 Zange mit halbrunden Backen, extralang, gerade = 180 mm
- 1 Zangen mit halbrunden Backen, gerade ● 160 mm
- 1 Diagonalseitenschneider für geringen Kraftaufwand ✂ 160 mm
- 1 Verstellbare Zangen 250 mm
- 1 Gripzange, verstellbar 240 mm
- 1 Zangen mit geraden Backen für Sicherungsringe mit Innenspannung ○ 180 mm
- 1 Zangen mit um 90° gebogenen Backen für Sicherungsringe mit Innenspannung ○ 170 mm
- 1 Zangen mit geraden Backen für Sicherungsringe mit Außenspannung ● 175 mm
- 1 Zangen mit um 90° gebogenen Backen für Sicherungsringe mit Außenspannung ● 175 mm
- 1 Zangen mit geraden Backen für Sicherungsringe mit Innenspannung ○ 140 mm
- 1 Zangen mit um 90° gebogenen Backen für Sicherungsringe mit Innenspannung ○ 225 mm
- 1 Zangen mit geraden Backen für Sicherungsringe mit Außenspannung ● 140 mm
- 1 Zangen mit um 90° gebogenen Backen für Sicherungsringe mit Außenspannung ● 225 mm
- 1 Schlosserhammer, deutsches Modell 400 g
- 1 Hammer mit auswechselbaren Kunststoffaufsätzen Ø 35 mm
- 1 Feilen für normale Bearbeitung 200 mm
- 1 Feilen für normale Bearbeitung 200 mm
- 1 Feilen für normale Bearbeitung 200 mm
- 1
- 1 flexibler Maßstab 300 mm
- 1 Rollbandmaße 5 m
- 1 Nietzange 250 mm
- 100 Aluminiumnieten 2,9x6 mm
- 100 Aluminiumnieten 3,2x8 mm
- 100 Aluminiumnieten 3,8x10 mm
- 100 Aluminiumnieten 4x12 mm
- 100 Aluminiumnieten 4,8x12 mm
- 1 Figurenschere, amerikanisches Modell 250 mm
- 1 Elektrikerschere, gerade Schneiden
- 1 Sägebogen
- (5) Sägeblätter
- 1 Metallölkanne mit Pumpe 200 cc
Thermoformateinsatz

Beta Nr.	TR
42	T05
42	T06
31	T31
32	T31
55	T31
96N/SC9	T31
1260	T167
1260N	T167
1262	T202
1267TX	T205
920ME	T80
920/21	T80
920/22	T80
920/25	T80
920/42	T80
920/55	T80
920A	T80
930	T73
940/1	T73
940/2	T73
951	T68
1150BM	T137
1166BM	T137
1084BM	T137
1048N	T153
1052	T153
1032	T145
1034	T145
1036	T145
1038	T145
1032	T146
1034	T146
1036	T146
1038	T146
1370	T231
1390	T231
1719BMA8T	T231
1719BMA8P	T231
1719BMA8M	T231
1651DGTB	T297
1682	T297
1691BM	T297
1741B	T281
1741RV...K	T281
1741RV...K	T281
1741RV...K	T281
1741RV...K	T281
1741RV...K	T281
1112	T279
1128BM	T279
1726	T279
1728BM	T279
1751N	T279
VP6	VP6



€ 2.860,00 059041168

Sortiment empfohlen in Kombination mit RSC24 mit 8 Schubladen - RSC24A mit 8 Schubladen - RSC24AXL mit 8-9 Schubladen
- RSC28 - C37 mit 8 Schubladen - C39 mit 8 Schubladen - C39MD - C39SM - RSC55 - C59B

5908VI/2T

Werkzeugsortiment, 232-teilig, im festen Thermoformateinsatz aus ABS

► Industriewartung

Stück / Beschreibung

- 5 Sechskant-Steckschlüssel mit Innenvierkantantrieb, 1/2" \odot 5 - 6 - 8 - 10 - 12 mm
- 1 Verlängerung, 1/2" 125 mm
- 1 Verlängerung, 1/2" 255 mm
- 1 Kardangelenk, 1/2"
- 1 Gleitgriff, 1/2"
- 1 Umschaltknarre, 1/2" \oplus
- 19 Sechskant-Steckschlüssel, 1/2" \odot 10+24 - 26 - 27 - 30 - 32 mm
- 16 Ring-Maulschlüssel 6÷21 mm
- 5 Ring-Maulschlüssel 22 - 24 - 27 - 30 - 32 mm
- 13 Sechskant-Steckschlüssel, 1/4" \odot 4+14 mm
- 6 Sechskant-Steckschlüssel 1/4" \odot 2,5 - 3 - 4 - 5 - 6 - 8 mm
- 1 Verlängerung, - 1/4" 50 mm
- 1 Verlängerung, - 1/4" 150 mm
- 1 Steckgriff, 1/4"
- 1 Kardangelenk, 1/4"
- 1 Gleitgriff, 1/4"
- 1 Umschaltknarre, 1/4" \oplus
- 6 Stiftschlüssel mit T-Griff, Sechskantprofil an drei Enden 2,5 - 3 - 4 - 5 - 6 - 8 mm
- 7 Doppelringschlüssel, tief gekröpft 6x7-8x9-10x11-12x13-14x15-16x17-18x19 mm
- 5 Doppelringschlüssel, tief gekröpft 20x22 - 21x23 - 24x26 - 25x28 - 27x29 mm
- 7 Schraubendreher für Schlitzschrauben \bullet 2,5x50 - 3x75 - 3,5x100 - 4x125 - 5,5x100 - 5,5x150 - 6,5x150 mm
- 6 Schraubendreher für Phillips®-Schrauben \oplus PH0x60 - PH0x100 - PH1x80 - PH1x120 - PH2x100 - PH2x150 mm
- 3 Schraubendreher für Schlitzschrauben \bullet 8x200 - 10x150 - 10x200 mm
- 2 Schraubendreher für Schlitzschrauben, extrakurze Klinge \bullet 4x30 - 6,5x30 mm
- 2 Schraubendreher für Phillips®-Schrauben \oplus PH3x150 - PH4x200 mm
- 2 Schraubendreher für Phillips® - Schrauben, extrakurze Klinge \oplus PH1x30 - PH2x30 mm
- 2 Flachmeißel, mit Hohlprofil 100 - 200 mm
- 1 Schlosserhammer, deutsches Modell 300 g
- 1 Hammer mit auswechselbaren Kunststoffaufsätzen \varnothing 35 mm
- 1 Nietzange 250 mm
- 100 Aluminiumnieten 2,9x6 mm
- 100 Aluminiumnieten 3,2x8 mm
- 100 Aluminiumnieten 3,8x10 mm
- 100 Aluminiumnieten 4x12 mm
- 100 Aluminiumnieten 4,8x12 mm
- 1 Verstellbare Zangen 250 mm
- 1 Gripzange, verstellbar 240 mm
- 5 Feilensatz, 5-teilig, halbschlicht, mit Griff 200 mm
- 1 Zangen mit geraden Backen für Sicherungsringe mit Innenspannung \odot 180 mm
- 1 Zangen mit um 90° gebogenen Backen für Sicherungsringe mit Innenspannung \odot 170 mm
- 1 Zangen mit geraden Backen für Sicherungsringe mit Außenspannung \bullet 175 mm
- 1 Zangen mit um 90° gebogenen Backen für Sicherungsringe mit Außenspannung \bullet 175 mm
- 1 Zange mit halbrunden Backen, extralang, gerade \equiv 180 mm
- 1 Zangen mit halbrunden Backen, gerade \bullet 160 mm
- 1 Diagonalseitenschneider für geringen Kraftaufwand \leq 160 mm
- 5 Splinttreiber \varnothing 2 - 3 - 4 - 5 - 6 mm
- 1 Körner \varnothing 4 mm
- 12 Doppelmaulschlüssel 6x7 - 8x9 - 10x11 - 12x13 - 14x15 - 16x17 - 18x19 - 20x22 - 21x23 - 24x26 - 27x29 - 30x32 mm
- 9 Sechskant-Stiftschlüssel, gebogen \odot 1,5 - 2 - 2,5 - 3 - 4 - 5 - 6 - 8 - 10 mm
- 1 Figureschere, amerikanisches Modell 250 mm
- 1 Elektrikerschere, gerade Schneiden
- 1 Sägebogen
- 5 Sägeblätter
- 1 Metallölkanne mit Pumpe 200 cc
- 1 Thermoformateinsatz
- 1 verstellbares Windeisen M3÷M12
- 1 verstellbares Windeisen M5÷M21
- 1 Werkzeughalter mit Umschaltknarre, kurz 2,0+5,0 mm (M3÷M8)
- 1 Werkzeughalter mit Umschaltknarre, kurz 4,6+8,0 mm (M5÷M12)
- 1 Schneideisenhalter 25,4 mm
- 1 Schneideisenhalter 38,1 mm
- 1 Gewindelehre 0,25÷6 W 62÷4x1"
- 26 Handgewindebohrer, hohe Steigung, metrisches Gewinde M3 - 4 - 5 - 6 - 7 - 8 - 9 - 10 - 12 - 14 - 16 - 18 - 20
- 14 Handgewindebohrer, niedrige Steigung, metrisches Gewinde M6x0,75 - M8x1 - M10x1,25 - M12x1,5 - M14x1,5 - M16x1,5 - M18x1,5
- 7 Gewindeschneideisen, rund, hohe Steigung, metrisches Gewinde M3 - 4 - 5 - 6 - 7 - 8 - 9
- 6 Gewindeschneideisen, rund, hohe Steigung, metrisches Gewinde M10 - 12 - 14 - 16 - 18 - 20
- 2 Gewindeschneideisen, rund, niedrige Steigung, metrisches Gewinde M6x0,75 - M8x0,75
- 5 Gewindeschneideisen, rund, niedrige Steigung, metrisches Gewinde M10x1,25 - M12x1,5 - M14x1,5 - M16x1,5 - M18x1,5

Beta Nr.	TR
920ME	T80
920/21	T80
920/22	T80
920/25	T80
920/42	T80
920/55	T80
920A	T80
42	T05
42	T06
900	T91
900ME	T91
900/20	T91
900/21	T91
900BG/30	T91
900/25	T91
900/42	T91
900/55	T91
951	T68
90	T40
90	T41
1260	T199
1262	T202
1260	T201
1260N	T201
1262	T204
1262N	T204
35	T234
1370	T234
1390	T234
1741B	T281
1741RV..K	T281
1741RV..K	T281
1741RV..K	T281
1741RV..K	T281
1741RV..K	T281
1048N	T153
1052	T153
1719BMA..S5	T236
1032	T145
1034	T145
1036	T145
1038	T145
1150BM	T137
1166BM	T137
1084BM	T137
31	T31
32	T31
55	T31
96N/SC9	T31
1112	T279
1128BM	T279
1726	T279
1728BM	T279
1751N	T279
VP5	VP5
435/1,5	T273
435/3	T273
436/1	T273
436/2	T273
444/1	T273
444/2	T273
1707	T273
430	T270
433	T270
440	T270
440A	T270
441	T270
441A	T270



5908VI/2T € 3.780,00 059081105

Sortiment empfohlen in Kombination mit RSC28 - RSC24/8 - RSC24A/8 - RSC24AXL mit 8-9 Schubladen - C37/8 - C39/8 - C59B



5910VI/3

Werkzeugsortiment, 297-teilig

► Industriewartung

Stück / Beschreibung	Beta Nr.
6 Ø 2 - 3 - 4 - 5 - 6 - 8 mm	31/B6N
1 Körner Ø 4 mm	32
2 Flachmeißel, mit Hohlprofil 125 - 250 mm	35
1 Kreuzmeißel, mit Hohlprofil 200 mm	37
30 Ring-Maulschlüssel 6-7-8-9-10-11-12-13-14-15-16-17-18-19-20-21-22-23-24-25-26-27-28-29-30-32-35-36-38-41 mm	42
14 Doppelmaulschlüssel 6x7 - 8x9 - 10x11 - 12x13 - 14x15 - 16x17 - 18x19 - 20x22 - 21x23 - 24x26 - 25x28 - 27x29 - 30x32 - 36x41 mm	55
13 Doppelringschlüssel, tief gekröpft 6x7÷30x32 mm	90
14 Sechskant-Stiftschlüssel, gebogen Ø 1,5 - 2 - 2,5 - 3 - 4 - 5 - 6 - 8 - 10 - 12 - 13 - 14 - 17 - 19 mm	96N
1 Einmaulschlüssel, verstellbar 250 mm	111E
1 Rohrzange, amerikanisches Modell 300 mm	362
25 Spiralbohrer, zylindrisch, kurze Ausführung 1÷13x0,5 mm	412/SP25
37 Sortiment mit Gewindebohrern und Schneideisen, aus HSS	447/C37
1 Drehmomentschlüssel mit Signalgebung ZERO-RESET Ⓢ 1/2", 40÷200 Nm	666/20
1 Verlängerung mit Kardangelenken, 1/2"	920/40
4 Sechskant-Steckschlüssel mit Innenvierkantantrieb, 1/2" Ø 10-12-14-17 mm	920ME
25 20 Steckschlüssel und 5 Betätigungswerkzeuge	920A/C20X
17 Sortiment mit 12 Steckschlüsseln und 5 Betätigungswerkzeugen 3/4"	928A/C12
12 Doppelsteckschlüssel, abgewinkelt, 12kant x 6kant 8 - 10 - 11 - 13 - 14 - 17 - 19 - 22 - 24 - 27 - 30 - 32 mm	932
14 Stiftschlüssel mit T-Griff, Sechskantprofil an drei Enden 2÷14 mm	951/S14
5 Gelenkkopf - Stiftschlüssel mit T - Griff, Sechskantprofil Ø 3 - 4 - 5 - 6 - 8 mm	953
3 Zangen mit geraden Backen für Sicherungsringe mit Innenspannung Ø 180 - 225 - 300 mm	1032
3 Zangen mit um 90° gebogenen Backen für Sicherungsringe mit Innenspannung Ø 170 - 210 - 290 mm	1034
3 Zangen mit geraden Backen für Sicherungsringe mit Außenspannung ● 140x1,3 - 175 - 225 mm	1036
3 Zangen mit um 90° gebogenen Backen für Sicherungsringe mit Außenspannung ● 135x1,3 - 175 - 220 mm	1038
2 Verstellbare Zangen 250 - 300 mm	1048N
1 Gripzange, zweifach verstellbar	1051
1 Diagonalseitenschneider für geringen Kraftaufwand, Griffe aus Bimaterial, Industrie-Finish ⚡ 160 mm	1084GBM
1 Hebelvornschneider, schwere Ausführung ⚡ 180 mm	1092V
1 Figureschere, amerikanisches Modell 300 mm	1112
1 Figureschere mit schmalen, geraden Schneiden 250 mm	1114
1 Elektrikerschere, gerade Schneiden	1128BMX
1 Universalzangen für geringen Kraftaufwand, Griffe aus Bimaterial, Industrie-Finish ≡ 180 mm	1150GBM
1 Zangen mit halbrunden Backen, extralang, gerade, innengeriffelt, Griffe aus Bimaterial, Industrie-Finish ● 160 mm	1166GBM
1 Zangen mit halbrunden Backen, extralang, gebogen, innengeriffelt, Griffe aus Bimaterial, Industrie-Finish ● 160 mm	1168GBM
9 Schraubendreher für Schlitzschrauben ● 2,5x50 - 3x75 - 3,5x150 - 4x125 - 5,5x125 - 6,5x150 - 8x200 - 10x200 - 12x250 mm	1260
2 Schraubendreher für Schlitzschrauben, extrakurze Klinge ● 4x30 - 6,5x30 mm	1260N
5 Schraubendreher für Phillips®-Schrauben ⚡ PH0x100 - PH1x120 - PH2x150 - PH3x150 - PH4x200 mm	1262
2 Schraubendreher für Phillips® - Schrauben, extrakurze Klinge ⚡ PH1x30 - PH2x30 mm	1262N
7 Stiftschlüssel für Torx®-Schrauben ⚡ T6 - T8 - T10 - T15 - T20 - T25 - T30	1267TX
2 Schlosserhammer, deutsches Modell 300 - 600 g	1370
2 Hammer mit auswechselbaren Kunststoffaufsätzen Ø 35 - 60 mm	1390
5 Schraubenausdreher M3÷M18	1430/S5
1 Universal - Abzieher mit zwei Armen 23÷70 mm	1500N/1
1 Universal - Abzieher mit zwei Armen 23÷100 mm	1500N/2
1 Schieblehre	1650
1 halbflexibler Maßstab 300 mm	1683
1 Reißnadel	1688A
1 Rollbandmaß 5 m	1692
1 Fühlerlehre	1708/13
1 Magnetheber, flexibel 1,8 kg	1712E/2
5 Feilen für normale Bearbeitung 200 mm	1719BMA8/S5
1 Sägebogen	1726BM
1 Nietzange	1741B
1 Metallölkanne mit Pumpe 200 cc	1751N

€

5910VI/3 7.880,00 059101044

Sortiment empfohlen in Kombination mit Art. C30M

5910VI/3T

Werkzeugsortiment, 261-teilig, im festen Thermoformateinsatz aus ABS

► Industriewartung

Stück / Beschreibung

Beta Nr. TR

16	Ring-Maulschlüssel 6+21 mm	42	T05
5	Ring-Maulschlüssel 22 - 24 - 27 - 30 - 32 mm	42	T06
5	Splinttreiber Ø 2 - 3 - 4 - 5 - 6 mm	31	T31
1	Körner Ø 4 mm	32	T31
13	Doppelmaulschlüssel 6x7 - 8x9 - 10x11 - 12x13 - 14x15 - 16x17 18x19 - 20x22 - 21x23 - 24x26 - 27x29 - 30x32 mm	55	T31
9	Sechskant-Stiftschlüssel, gebogen ○ 1,5 - 2 - 2,5 - 3 - 4 - 5 - 6 - 8 - 10 mm	96N/SC9	T31
7	Doppelringschlüssel, tief gekröpft 20x22 - 21x23 - 24x26 - 25x28 - 27x29 mm	90	T41
7	Doppelringschlüssel, tief gekröpft 6x7 - 8x9 - 10x11 - 12x13 - 14x15 - 16x17 18x19 mm	90	T40
5	Sechskant-Steckschlüssel mit Innenvierkanttrieb, 1/2" ○ 5 - 6 - 8 - 10 - 12 mm	920ME	T80
1	Verlängerung, 1/2" 125 mm	920/21	T80
1	Verlängerung, 1/2" 255 mm	920/22	T80
1	Kardangelenke, 1/2"	920/25	T80
1	Gleitgriff, 1/2"	920/42	T80
1	Umschaltknarre, 1/2" Ⓢ	920/55	T80
19	Sechskant-Steckschlüssel, 1/2" ○ 10+24 - 26 - 27 - 30 - 32 mm	920A	T80
9	Schraubendreher für Schlitzschrauben ● 3x75 - 3x100 - 4x100 - 4x150 - 5,5x100 - 5,5x150 - 6,5x150 - 8x150 - 10x200 mm	1260	T167
2	Schraubendreher für Schlitzschrauben, extrakurze Klinge ● 4x30 - 6,5x30 mm	1260N	T167
7	Schraubendreher für Phillips®-Schrauben Ⓢ PH0x60 - PH0x100 - PH1x80 - PH1x120 - PH2x100 - PH2x150 - PH3x150 mm	1262	T168
2	Schraubendreher für Phillips® - Schrauben, extrakurze Klinge Ⓢ PH1x30 - PH2x30 mm	1262N	T168
4	Sechskant-Stiftschlüssel, gebogen ○ 13-14-17-19 mm	96N	T168
1	Figureschere, amerikanisches Modell 250 mm	1112	T279
1	Elektrikerschere, gerade Schneiden	1128BM	T279
1	Sägebogen	1726	T279
(5)	Sägeblätter	1728BM	T279
1	Metallölkanne mit Pumpe 200 cc	1751N	T279
1	Zange mit halbrunden Backen, extralang, gerade ≡ 180 mm	1150BM	T137
1	Zangen mit halbrunden Backen, gerade ● 160 mm	1166BM	T137
1	Diagonalseitenschneider für geringen Kraftaufwand ≲ 160 mm	1084BM	T137
1	Zangen mit geraden Backen für Sicherungsringe mit Innenspannung ○ 180 mm	1032	T145
1	Zangen mit um 90° gebogenen Backen für Sicherungsringe mit Innenspannung ○ 170 mm	1034	T145
1	Zangen mit geraden Backen für Sicherungsringe mit Außenspannung ● 175mm	1036	T145
1	Zangen mit um 90° gebogenen Backen für Sicherungsringe mit Außenspannung ● 175mm	1038	T145
2	Flachmeißel, mit Hohlprofil 100 - 200 mm	35	T234
1	Schlosserhammer, deutsches Modell 300 g	1370	T234
1	Hammer mit austauschbaren Kunststoffaufsätzen Ø 35 mm	1390	T234
1	Feilen für normale Bearbeitung 200 mm	1719BMA8/S5	T236
4	Ring-Maulschlüssel 35-36-38-41 mm	42	
1	Doppelmaulschlüssel 36x41 mm	55	
1	Einmaulschlüssel, verstellbar 250 mm	111E	
1	Rohrzange, amerikanisches Modell 300 mm	362	
25	Spiralbohrer, zylindrisch, kurze Ausführung	412/SP25	
37	Sortiment mit Gewindebohrern und Schneideisen, aus HSS	447/C37	
1	Drehmomentschlüssel mit Signalgebung ZERO-RESET Ⓢ 40+200 Nm	666/20	
17	Sortiment mit 12 Steckschlüsseln und 5 Betätigungswerkzeugen 3/4"	928A/C12	
14	Stiftschlüssel mit T-Griff, Sechskantprofil an drei Enden	951/S14	
5	Gelenkkopf - Stiftschlüssel mit T - Griff, Sechskantprofil ○ 3-4-5-6-8 mm	953	
1	Zangen mit geraden Backen für Sicherungsringe mit Innenspannung ○ 300 mm	1032	
1	Zangen mit um 90° gebogenen Backen für Sicherungsringe mit Innenspannung ○ 290 mm	1034	
1	Zangen mit geraden Backen für Sicherungsringe mit Außenspannung ● 225 mm	1036	
1	Zangen mit um 90° gebogenen Backen für Sicherungsringe mit Außenspannung ● 220 mm	1038	
1	Verstellbare Zangen 300 mm	1048N	
1	Gripzange, zweifach verstellbar	1051	
1	Hebelvornschneider, schwere Ausführung ≲ 180 mm	1092V	
1	Schlosserhammer, deutsches Modell 600 g	1370	
1	Hammer mit austauschbaren Kunststoffaufsätzen 60 mm	1390	
5	Schraubenausdreher M3-M18	1430/S5	
1	Universal - Abzieher mit zwei Armen	1500/3	
1	Schieblehre	1650	
1	halbflexibler Maßstab	1683	
1	Reißnadel	1688	
1	Rollbandmaß 5 m	1692	
1	Fühlerlehre	1708/13	
1	Magnetheber, flexibel	1712E/2	



€



5910VI/3T

6.730,00 059101063

Sortiment empfohlen in Kombination mit Art. C30M

5935VI/2MB

Werkzeugsortiment, 133-teilig, für Werkzeugkasten C35, im Schaumstoffeinsatz aus EVA

► Industriewartung

Stück / Beschreibung

- 21 Ring-Maulschlüssel 6-7-8-9-10-11-12-13-14-15-16-17-18-19-20-21-22-24-27-30-32 mm
- 8 Doppelmaulschlüssel 6x7-8x9-10x11-12x13-14x15
16x17-18x19-20x22 mm
- 1 Verstellbare Zangen 250 mm
- 19 Sechskant-Steckschlüssel, 1/2" ○ 10-11-12-13-14-15-16-17-18-19
20-21-22-23-24-26-27-30-32 mm
- 1 Verlängerung, schwenkbar - 1/2" 125 mm
- 1 Verlängerung, schwenkbar - 1/2" 150 mm
- 1 Kardangelenke, 1/2"
- 1 Gleitgriff, 1/2"
- 1 Umschaltknarre, 1/2" ⊕
- 1 Einmaulschlüssel, verstellbar 250 mm
- 1 Gripzange, verstellbar 240 mm
- 1 Diagonalseitenschneider für geringen Kraftaufwand ≡ 160 mm
- 1 Zange mit halbrunden Backen, extralang, gerade ≡ 180 mm
- 1 Zangen mit halbrunden Backen, gerade ● 160 mm
- 1 Zangen mit geraden Backen für Sicherungsringe mit Innenspannung ○ 180 mm
- 1 Zangen mit um 90° gebogenen Backen für Sicherungsringe mit Innenspannung ○ 170 mm
- 1 Zangen mit geraden Backen für Sicherungsringe mit Außenspannung ● 175 mm
- 1 Zangen mit um 90° gebogenen Backen für Sicherungsringe mit Außenspannung ● 175 mm
- 13 Sechskant-Steckschlüssel, 1/4" ○ 4-4,5-5-5,5-6-7-8-9-10-11-12-13-14 mm
- 1 Verlängerung, - 1/4" 50 mm
- 1 Verlängerung, - 1/4" 150 mm
- 1 Kardangelenke, 1/4"
- 1 Steckgriff, 1/4"
- 1 Umschaltknarre, 1/4" ⊕
- 1 Gleitgriff, 1/4"
- 7 Schraubendreher für Schlitzschrauben
● 2,5x50-3x75-3,5x100-4x100-5,5x125-6,5x150-8x200 mm
- 2 Schraubendreher für Schlitzschrauben, extrakurze Klinge ● 4x30-6,5x30 mm
- 7 Schraubendreher für Phillips®-Schrauben ⊕ PH0x60-PH0x100-PH1x80-PH1x120-PH2x100-
PH2x150-PH3x150 mm
- 2 Schraubendreher für Phillips® - Schrauben, extrakurze Klinge ⊕ PH1x30-PH2x30 mm
- 1 Schraubendreher mit Spannungsprüfer ● 4x30-6,5x30 mm
- 9 Sechskant - Stiftschlüssel, gebogen, mit kugelförmigem Kopf ○
- 6 Stiftschlüssel mit T-Griff, Sechskantprofil an drei Enden 2,5-3-4-5-6-8 mm
- 5 Splinttreiber Ø 2-3-4-5-6 mm
- 1 Körner Ø 4 mm
- 1 Flachmeißel, mit Hohlprofil 200 mm
- 1 Figureschere, amerikanisches Modell 250 mm
- 1 Elektrikerschere, gerade Schneiden
- 1 Schlosserhammer, deutsches Modell 500 g
- 1 Hammer mit auswechselbaren Kunststoffaufsätzen Ø 45 mm
- 1 Vierkantfeilen halbschlicht 200 mm
- 1 Dreieckfeilen, halbschlicht 200 mm
- 1 Flachfeilen halbschlicht 200 mm
- 1 Halbrundfeilen halbschlicht 200 mm
- 1 Rundfeilen halbschlicht 200 mm
- 1 Sägebogen 440 mm

Beta Nr.	TR
42	MB12
55	MB12
1048N	MB12
920A	MB37
920AN/125	MB37
920AN/250	MB37
920/25	MB37
920/42	MB37
920/55	MB37
111E	MB37
1052	MB37
1084BM	MB37
1150BM	MB37
1166BM	MB37
1032	MB37
1034	MB37
1036	MB37
1038	MB37
900	MB37
900/20	MB37
900/21	MB37
900/25	MB37
900BG/30	MB37
900/55	MB37
900/42	MB37
1260	MB44
1262	MB44
1262N	MB44
1253	MB44
96BPC/SC9	MB44
951	MB44
31	MB55
32	MB55
35	MB55
1112	MB55
1128BMX	MB55
1370	MB55
1390	MB55
1719BMA...Q	MB55
1719BMA...T	MB55
1719BMA...P	MB55
1719BMA...M	MB55
1719BMA...R	MB55
1726	MB55



MB12



MB37



MB44



MB55



5935VI/2MB 2.600,00 059351316

Sortiment empfohlen in Kombination mit C35



5957VI

Werkzeugsortiment, 162teilig

► Industrierwartung

Stück / Beschreibung	Beta Nr.
6 Splinttreiber Ø 2 - 3 - 4 - 5 - 6 - 8 mm	31/SP6
6 2 Durchschläger, 1 Körner, 3 Meißel mit Ständer	38/SP6
18 Ring-Maulschlüssel 6-7-8-10-11-12-13-14-15-16-17-19-21-22-24-27-30-32 mm	42
12 Doppelmaulschlüssel 6x7 ÷ 30x32 mm	55/S12X
8 Sechskant - Stiftschlüssel mit Griff 2 - 2,5 - 3 - 4 - 5 - 6 - 8 - 10 mm	96T/S8
8 Stiftschlüsselsatz, 8teilig, gebogen, für Torx®-Schrauben ⌀ T9 - T10 - T15 - T20 - T25 - T27 - T30 - T40	97TX/SC8
1 Einmaulschlüssel, verstellbar 250 mm	111E
13 Zwölfkant-Steckschlüssel, 1/2", mit Halter ⌀ 10+22 mm	920B/SB13
8 Zwölfkant-Steckschlüssel, 1/2", mit Halter ⌀ 23+32 mm	920B/SB8
4 Schraubendrehereinsätze für Schlitzschrauben ● 1,2x6,5 - 1,2x8 - 1,6x9 - 2x12 mm	920LP
3 Schraubendrehereinsätze für Phillips® - Schrauben ⚙ PH2 - 3 - 4	920PH
1 Verlängerung, 1/2" 125 mm	920/21
1 Verlängerung, 1/2" 255 mm	920/22
1 Kardangelenk, 1/2"	920/25
1 Gleitgriff, 1/2"	920/42
1 Umschaltknarre, 1/2" Ⓢ	920/55
1 Hebeleisen, gerade	963
2 Zangen mit geraden Backen für Sicherungsringe mit Innenspannung ⌀ 140 - 180 mm	1032
2 Zangen mit um 90° gebogenen Backen für Sicherungsringe mit Innenspannung ⌀ 130 - 170 mm	1034
2 Zangen mit geraden Backen für Sicherungsringe mit Außenspannung ● 140 - 175 mm	1036
2 Zangen mit um 90° gebogenen Backen für Sicherungsringe mit Außenspannung ● 135 - 175 mm	1038
1 Verstellbare Zangen 250 mm	1048N
1 Gripzange, zweifach verstellbar	1051
1 Diagonalseitenschneider für geringen Kraftaufwand ≤ 160 mm	1084BM
1 Hebelvornschneider, schwere Ausführung ≤ 180 mm	1092V
1 Figureschere, amerikanisches Modell 250 mm	1112
1 Figureschere mit schmalen, geraden Schneiden 250 mm	1114
1 Elektrikerschere, gerade Schneiden	1128BMX
1 Zange mit halbrunden Backen, extralang, gerade = 180 mm	1150BM
1 Zangen mit halbrunden Backen, gerade ● 160 mm	1166BM
1 Zangen mit halbrunden Backen, gebogen ● 160 mm	1168BM
7 Schraubendreher für Schlitzschrauben ● 2,5x50 - 3x75 - 4x100 - 5,5x125 - 6,5x150 - 8x200 - 10x200 mm	1260
4 Schraubendreher für Phillips®-Schrauben ⚙ PH0x60 - PH1x80 - PH2x100 - PH3x150 mm	1262
3 Schlosserhammer, deutsches Modell 300 - 600 - 1000 g	1370
1 Hammer mit auswechselbaren Kunststoffaufsätzen Ø 35 mm	1390
1 Rollbandmaß 5 m	1692
1 Magnetheber, flexibel 1,8 kg	1712E/2
1 Löffelschaber 200 mm	1717A
1 Dreikantschaber 200 mm	1717B
5 Feilen für normale Bearbeitung 200 mm	1719BMA8/S5
1 Sägebogen	1725
1 Metallölkanne mit Pumpe 200 cc	1751
1 Flachmeißel, mit Hohlprofil 200 mm	35
1 Kreuzmeißel, mit Hohlprofil 200 mm	37
11 Doppelsteckschlüssel, abgewinkelt, 12kant x 6kant 8 - 10 - 11 - 12 - 13 - 14 - 16 - 17 - 19 - 22 - 24 mm	932
1 Gripzange, verstellbar 240 mm	1052
1 Gripzange, verstellbar 280 mm	1060
1 Gripzange, verstellbar 290 mm	1062
1 rückschlagfreier Hammer Ø 50 mm	1392
1 Universal - Abzieher mit zwei Armen 25+130 mm	1500N/2
1 Schieblehre	1650
1 halbflexibler Maßstab 300 mm	1683
1 Reißnadel	1688A
1 Fühlerlehre	1708/13
1 Klappmesser	1777BM
1 Cutter 170 mm	1771BM
1 Diagonalseitenschneider ≤ 160 mm	1082BM

€

5957VI 4.010,00 059571005

Sortiment empfohlen in Kombination mit C57SA - C57SB - C57SP

5954VI

Werkzeugsortiment, 113 teilig



► Industriewartung

Stück / Beschreibung	Beta Nr.
5 Splinttreiber Ø 2-3-4-5-6 mm	31
1 Körner Ø 4 mm	32
2 Flachmeißel, mit Hohlprofil 200-250 mm	35
18 Ring-Maulschlüssel 6+14 - 16 - 17 - 18 19 - 21 - 22 - 24 - 27 - 30 mm	42
12 Doppelmaulschlüssel 6x7 - 8x9 - 10x11 - 12x13 - 14x15 - 16x17 18x19 - 20x22 - 21x23 - 24x26 - 27x29 - 30x32 mm	55
12 Sechskant-Stiftschlüssel, gebogen Ø 2+10 mm	96/SC12
1 Einmaulschlüssel, verstellbar 250 mm	111E
1 Rohrzange, schwedisches Modell 320 mm	374
20 Sechskant-Steckschlüssel, 1/2" Ø 10+24 - 26 - 27 - 28 - 30 - 32 mm	920A
6 Sechskant-Steckschlüssel mit Innenvierkantantrieb, 1/2" Ø 5 - 6 - 8 - 10 - 12 - 14 mm	920ME
1 Verlängerung, 1/2" 125 mm	920/21
1 Verlängerung, 1/2" 255 mm	920/22
1 Kardangelenk, 1/2"	920/25
1 Verlängerung mit Kardangelenk, 1/2"	920/40
1 Gleitgriff, 1/2"	920/42
1 Umschaltknarre, 1/2" ⊕	920/55
6 Stiftschlüssel mit T-Griff, Sechskantprofil an drei Enden 2,5 - 3 - 4 - 5 - 6 - 8 mm	951
2 Zangen mit geraden Backen für Sicherungsringe mit Innenspannung Ø 140 - 180 mm	1032
1 Zangen mit um 90° gebogenen Backen für Sicherungsringe mit Innenspannung Ø 170 mm	1034
2 Zangen mit geraden Backen für Sicherungsringe mit Außenspannung ● 140x1,3 - 175 mm	1036
1 Zangen mit um 90° gebogenen Backen für Sicherungsringe mit Außenspannung ● 175 mm	1038
1 Verstellbare Zangen 250 mm	1048N
1 Gripzange, verstellbar 240 mm	1052
1 Diagonalseitenschneider für geringen Kraftaufwand ⚡ 160 mm	1084BM
1 Hebelvornschneider, schwere Ausführung ⚡ 180 mm	1092V
1 Figureschere, amerikanisches Modell 250 mm	1112
1 Elektrikerschere, gerade Schneiden	1128BMX
1 Zange mit halbrunden Backen, extralang, gerade = 180 mm	1150BM
1 Zangen mit halbrunden Backen, gerade ● 160 mm	1166BM
1 Schraubendreher mit Spannungsprüfer ●	1253
2 Schraubendreher für Schlitzschrauben ● 8x150 - 10x200 mm	1260
2 Schraubendreher für Schlitzschrauben, extrakurze Klinge ● 4x30 - 6,5x30 mm	1260N
2 Schraubendreher für Phillips®-Schrauben ⊕ PH3x150 - PH4x200 mm	1262
2 Schraubendreher für Phillips® - Schrauben, extrakurze Klinge ⊕ PH1x30 - PH2x30 mm	1262N
8	1263/D8
2 Schlosserhammer, deutsches Modell 300 - 500 g	1370
1 Hammer mit auswechselbaren Kunststoffaufsätzen Ø 45 mm	1390
1 Rollbandmaß 5 m	1692
1 Magnetheber, flexibel 0,5 kg	1712E/1
5 Feilen für normale Bearbeitung 200 mm	1719BMA8/S5
1 Sägebogen	1726BM
1 Kunststoffölkanne mit Pumpe 250 cc	1754

€

5954VI 2.740,00 059541053

Sortiment empfohlen in Kombination mit C54S-C55C

5904VU/1M

Werkzeugsortiment, 90-teilig, im Schaumstoffeinsatz aus EVA

► Universalsortimente

Stück / Beschreibung

- 16 Ring-Maulschlüssel 6÷21 mm
- 8 Doppelmaulschlüssel 6x7 - 8x9 - 10x11 - 12x13 - 14x15 - 16x17
18x19 - 20x22 mm
- 9 Sechskant-Stiftschlüssel, gebogen \odot 1,5 - 2 - 2,5 - 3 - 4 - 5 - 6 - 8 - 10 mm
- 6 Stiftschlüssel für Torx®-Schrauben \odot T8-T10-T15-T20-T25-T30
- 3 Schraubendreher für Schlitzschrauben \bullet 3x75-4x100-6,5x150 mm
- 3 Schraubendreher für Phillips®-Schrauben \oplus PH0x60-PH1x80-PH2x100 mm
- 8 Sechskant - Stiftschlüssel mit Griff \odot 2-2,5-3-4-5-6-7-8 mm
- 1 Verlängerung, schwenkbar - 1/2" 125 mm
- 1 Verlängerung, schwenkbar - 1/2" 250 mm
- 1 Kardangelenke, 1/2"
- 1 Gleitgriff, 1/2"
- 1 Umschaltknarre, 1/2" \oplus
- 19 Sechskant-Steckschlüssel, 1/2" \odot 10÷24 - 26 - 27 - 30 - 32 mm
- 1 Diagonalseitenschneider für geringen Kraftaufwand ∇ 160 mm
- 1 Zange mit halbrunden Backen, extralang, gerade \equiv 180 mm
- 1 Zangen mit halbrunden Backen, gerade \bullet 160 mm
- 1 Verstellbare Zangen 250 mm
- 1 Gripzange, verstellbar 240 mm
- 2 Flachmeißel, mit Hohlprofil 100 - 200 mm
- 1 Schlosserhammer, deutsches Modell 300 g
- 1 Hammer mit austauschbaren Kunststoffaufsätzen \varnothing 35 mm
- 1 Zangen mit geraden Backen für Sicherungsringe mit Innenspannung \odot 180 mm
- 1 Zangen mit um 90° gebogenen Backen für Sicherungsringe mit Innenspannung \odot 170 mm
- 1 Zangen mit geraden Backen für Sicherungsringe mit Außenspannung \bullet 175 mm
- 1 Zangen mit um 90° gebogenen Backen für Sicherungsringe mit Außenspannung \bullet 175 mm

Beta Nr.	TR
42	M05
55	M33
96/SC9	M33
1267TX	M204
1260	M201
1262	M201
96T	M50
920AN/125	M83
920AN/250	M83
920/25	M83
920/42	M83
920/55	M83
920A	M83
1084	M137
1150	M137
1166	M137
1048N	M153
1052	M153
35	M234
1370	M234
1390	M234
1032	M145
1034	M145
1036	M145
1038	M145



€



5904VU/1M

1.580,00 059041201

Sortiment empfohlen in Kombination mit RSC51 - RSC23T - RSC24 - RSC24A - RSC24AXL - RSC24L/7 - RSC24L-CAB - RSC28
C37 - C39 - C39T - C39SM - C39MD - RSC50 - RSC55 - C59

5904VU/2M

Werkzeugsortiment, 144-teilig, im Schaumstoffeinsatz aus EVA

► Universalsortimente

Stück / Beschreibung

- 16 Ring-Maulschlüssel 6÷21 mm
- 8 Doppelmaulschlüssel 6x7 - 8x9 - 10x11 - 12x13 - 14x15 - 16x17 - 18x19 - 20x22 mm
- 9 Sechskant-Stiftschlüssel, gebogen \odot 1,5 - 2 - 2,5 - 3 - 4 - 5 - 6 - 8 - 10 mm
- 3 Schraubendreher für Schlitzschrauben \bullet 3x75-4x100-6,5x150 mm
- 3 Schraubendreher für Phillips®-Schrauben \oplus PH0x60-PH1x80-PH2x100 mm
- 6 Stiftschlüssel für Torx®-Schrauben \odot T8-T10-T15-T20-T25-T30
- 8 Sechskant - Stiftschlüssel mit Griff \odot 2-2,5-3-4-5-6-7-8 mm
- 1 Verlängerung, schwenkbar - 1/2" 125 mm
- 1 Verlängerung, schwenkbar - 1/2" 250 mm
- 1 Kardangelenk, 1/2"
- 1 Gleitgriff, 1/2"
- 1 Umschaltknarre, 1/2" \oplus
- 19 Sechskant-Steckschlüssel, 1/2" \odot 10÷24 - 26 - 27 - 30 - 32 mm
- 1 Diagonalseitenschneider für geringen Kraftaufwand \leq 160 mm
- 1 Zange mit halbrunden Backen, extralang, gerade \equiv 180 mm
- 1 Zangen mit halbrunden Backen, gerade \bullet 160 mm
- 1 Verstellbare Zangen 250 mm
- 1 Gripzange, verstellbar 240 mm
- 2 Flachmeißel, mit Hohlprofil 100 - 200 mm
- 1 Schlosserhammer 300 g
- 1 Hämmer \varnothing 35 mm
- 1 Zangen mit geraden Backen für Sicherungsringe mit Innenspannung \odot 180 mm
- 1 Zangen mit um 90° gebogenen Backen für Sicherungsringe mit Innenspannung \odot 170 mm
- 1 Zangen mit geraden Backen für Sicherungsringe mit Außenspannung \bullet 175 mm
- 1 Zangen mit um 90° gebogenen Backen für Sicherungsringe mit Außenspannung \bullet 175 mm
- 1
- 1 Rollbandmaß 5 m
- 1 Minisägebogen
- 1 Abbrechbare Klingen, 18 mm breit, 10 Stück, für Cutter Art. 1771, 1771BM, 1771HD
- 1 Cutter
- 5 Farbige Schraubeinsätze für Schlitzschrauben \bullet 0,5x3 - 0,6x4,5 - 0,8x5,5 - 1x5,5 - 1,2x6,5 mm
- 8 Farbige Sechskant-Schraubeinsätze \odot 2 - 2,5 - 3 - 4 - 5 - 6 - 8 - 10 mm
- 5 Farbige Schraubeinsätze für Phillips®-Schrauben \oplus PH0 - PH1 - PH2 - PH3 - PH4
- 4 Farbige Schraubeinsätze für Pozidriv®- und Supadriv®-Schrauben \oplus PZ1 - PZ2 - PZ3 - PZ4
- 11 Farbige Schraubeinsätze für Torx®-Schrauben \odot T6-T7-T8-T9-T10-T15-T20-T25-T27-T30-T40
- 8 Farbige Schraubeinsätze für Sicherheitsschrauben Tamper Resistant Torx® \oplus T9-T10-T15-T20-T25-T27-T30-T40
- 1 Einsatzhalter, mit Schnellanschluss und Griff 230 mm
- 1 Umschaltknarre für Einsatzhalter 100 mm
- 5 Feilen für normale Bearbeitung 200 mm
- 1 Adapter für Steckschlüssel
- 1 Magnetverlängerung für Einsatzhalter

Beta Nr.	TR
42	M05
55	M33
96/SC9	M33
1260	M201
1262	M201
1267TX	M204
96T	M50
920AN/125	M83
920AN/250	M83
920/25	M83
920/42	M83
920/55	M83
920A	M83
1084	M137
1150	M137
1150	M137
1166	M137
1048N	M153
1052	M153
35	M237
1370T	M237
1390N	M237
1032	M145
1034	M145
1036	M145
1038	M145
VPM3	VPM3
1692	M294
1725CR	M294
1771RL	M294
1771	M294
860LP	M85
860PE	M85
860PH	M85
860PZ	M85
860TX	M85
860RTX	M85
851SR	M85
860/55	M85
1719BMA8/S5	M236
892/0	M85
882P	M85



M05 M33 M204 M201



M50 M83



M137 M153 M237 M145



VPM3 M294 M85 M236

€

5904VU/2M

2.060,00 059041212

Sortiment empfohlen in Kombination mit RSC23T - RSC24 - RSC24A - RSC24AXL - RSC24L7 - RSC24L-CAB
RSC28 - C37 - C39 - C39SM - C39MD - C39T - RSC50 - RSC55 - C59

5904VU/2T

Werkzeugsortiment, 104-teilig, im festen Thermoformateinsatz aus ABS

► Universalsortimente

Stück / Beschreibung

Stück / Beschreibung	Beta Nr.	TR
7 Schraubendreher für Schlitzschrauben ● 2,5x50 - 3x75 - 3,5x100 - 4x125 5,5x100 - 5,5x150 - 6,5x150 mm	1260	T199
6 Schraubendreher für Phillips®-Schrauben ⊕ PH0x60 - PH0x100 - PH1x80 - PH1x120 - PH2x100 - PH2x150 mm	1262	T202
19 Sechskant-Steckschlüssel, 1/2" ○ 10-11-12-13-14-15-16-17-18-19 20-21-22-23-24-26-27-30-32 mm	920A	T83
1 Verlängerung, 1/2" 125 mm	920/21	T83
1 Verlängerung, 1/2" 255 mm	920/22	T83
1 Kardangelenk, 1/2"	920/25	T83
1 Gleitgriff, 1/2" 305 mm	920/42	T83
1 Umschaltknarre, 1/2" ⊗	920/55	T83
1 Zangen mit geraden Backen für Sicherungsringe mit Innenspannung ○ 180 mm	1032	T145
1 Zangen mit um 90° gebogenen Backen für Sicherungsringe mit Innenspannung ○ 170 mm	1034	T145
1 Zangen mit geraden Backen für Sicherungsringe mit Außenspannung ● 175 mm	1036	T145
1 Zangen mit um 90° gebogenen Backen für Sicherungsringe mit Außenspannung ● 175 mm	1038	T145
1 Verstellbare Zangen 250 mm	1048N	T153
1 Gripzange, verstellbar 240 mm	1052	T153
1 Diagonalseitenschneider für geringen Kraftaufwand ≤ 160 mm	1084	T138
1 Zange mit halbrunden Backen, extralang, gerade = 180 mm	1150	T138
1 Zangen mit halbrunden Backen, gerade ● 160 mm	1166	T138
2 Flachmeißel, mit Hohlprofil 100-200 mm	35	T234
1 Schlosserhammer, deutsches Modell 300 g	1370	T234
1 Hammer mit auswechselbaren Kunststoffaufsätzen Ø 35 mm	1390	T234
6 Stiftschlüssel mit T-Griff, Sechskantprofil an drei Enden 2,5-3-4-5-6-8 mm	951	T68
8 Doppelmaulschlüssel 6x7-8x9-10x11-12x13-14x15 16x17-18x19-20x22 mm	55	T33
9 Sechskant-Stiftschlüssel, gebogen ○ 1,5÷10 mm	96/SC9	T33
16 Ring-Maulschlüssel 6-7-8-9-10-11-12-13-14-15-16-17 18-19-20-21 mm	42	T05
5 Ring-Maulschlüssel 22-24-27-30-32 mm	42	T06
1 Elektrikerschere, gerade Schneiden	1128BMX	T284
1 Mehrzweckschere	1130BMX	T284
1 Vierkantfeilen halbschlicht 200 mm	1719BMA...Q	T284
1 Flachfeilen halbschlicht 200 mm	1719BMA...P	T284
1 Dreieckfeilen, halbschlicht 200 mm	1719BMA...T	T284
1 Halbrundfeilen halbschlicht 200 mm	1719BMA...M	T284
1 Rundfeilen halbschlicht 200 mm	1719BMA...R	T284
1 Sägebogen	1726BM	T284
1 Sägeblätter	1728BM	T284
1 Cutter 170 mm	1771BM	T284
1 185 mm	1778V18	T284

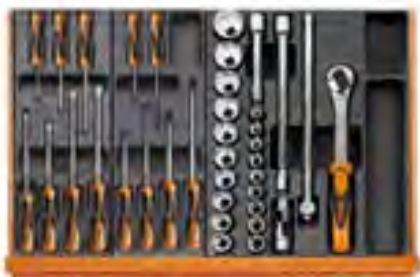

T199 T202 T83



T145 T153 T138 T234



T68 T33 T05 T06



T284



5904VU/2T 1.890,00 059041070

Sortiment empfohlen in Kombination mit RSC23T - RSC24 - RSC24A - RSC24AXL - RSC24L/7 - RSC24L-CAB - RSC28 - C37 - C39 - C39SM - C39MD - C39T - RSC50 - RSC55 - C59

5904VU/3T

Werkzeugsortiment, 146-teilig, im festen Thermoformateinsatz aus ABS

► Universalsortimente

Stück / Beschreibung

- 16 Ring-Maulschlüssel 6+21 mm
- 5 Ring-Maulschlüssel 22 - 24 - 27 - 30 - 32 mm
- 5 Splinttreiber Ø 2 - 3 - 4 - 5 - 6 mm
- 1 Körner Ø 4 mm
- 12 Doppelmaulschlüssel 6x7 - 8x9 - 10x11 - 12x13 - 14x15 - 16x17 - 18x19 - 20x22 - 21x23 - 24x26 - 27x29 - 30x32 mm
- 9 Sechskant-Stiftschlüssel, gebogen ○ 1,5 - 2 - 2,5 - 3 - 4 - 5 - 6 - 8 - 10 mm
- 6 Sechskant - Stiftschlüssel mit Griff ○ 2 - 2,5 - 3 - 4 - 5 - 6 mm
- 6 Stiftschlüssel mit Griff, für Torx®-Schrauben ○ T10-T15-T20-T25-T27-T30
- 5 Sechskant-Steckschlüssel mit Innenvierkantantrieb, 1/2" ○ 5 - 6 - 8 - 10 - 12 mm
- 1 Verlängerung, 1/2" 125 mm
- 1 Verlängerung, 1/2" 255 mm
- 1 Kardangelenke, 1/2"
- 1 Gleitgriff, 1/2"
- 1 Umschaltknarre, 1/2" ⊕
- 19 Sechskant-Steckschlüssel, 1/2" ○ 10+24 - 26 - 27 - 30 - 32 mm
- 13 Sechskant-Steckschlüssel, 1/4" ○ 4-4,5-5-5,5-6-7-8-9-10-11-12-13-14 mm
- 6 Sechskant-Steckschlüssel 1/4" ○ 2,5-3-4-5-6-8 mm
- 1 Verlängerung, - 1/4" 50 mm
- 1 Verlängerung, - 1/4" 150 mm
- 1 Kardangelenke, 1/4"
- 1 Steckgriff, 1/4"
- 1 Gleitgriff, 1/4" 115 mm
- 1 Umschaltknarre, 1/4" ⊕
- 1 Zangen mit geraden Backen für Sicherungsringe mit Innenspannung ○ 180 mm
- 1 Zangen mit um 90° gebogenen Backen für Sicherungsringe mit Innenspannung ○ 170 mm
- 1 Zangen mit geraden Backen für Sicherungsringe mit Außenspannung ● 175 mm
- 1 Zangen mit um 90° gebogenen Backen für Sicherungsringe mit Außenspannung ● 175 mm
- 1 Zange mit halbrunden Backen, extralang, gerade = 180 mm
- 1 Zangen mit halbrunden Backen, gerade ● 160 mm
- 1 Diagonalseitenschneider für geringen Kraftaufwand ✂ 160 mm
- 1 Verstellbare Zangen 250 mm
- 1 Gripzange, verstellbar 240 mm
- 4 Schraubendreher für Schlitzschrauben ● 3x75 - 4x100 - 5,5x150 - 6,5x150 mm
- 3 Schraubendreher für Pozidriv®-Supadriv®-Schrauben ⊕ PZ0 - PZ1 - PZ2
- 7 Stiftschlüssel für Torx®-Schrauben ⊕ T6-T7-T8-T9-T10-T15-T20
- 2 Flachmeißel, mit Hohlprofil 100 - 200 mm
- 1 Schlosserhammer, deutsches Modell 300 g
- 1 Hammer mit auswechselbaren Kunststoffaufsätzen Ø 35 mm
- 5 Feilen für normale Bearbeitung 200 mm

Beta Nr.	TR
42	T05
42	T06
31	T31
32	T31
55	T31
96N/SC9	T31
96T	T52
97TTX	T55
920ME	T80
920/21	T80
920/22	T80
920/25	T80
920/42	T80
920/55	T80
920A	T80
900	T91
900ME	T91
900/20	T91
900/21	T91
900/25	T91
900/25	T91
900BG/30	T91
900/42	T91
900/55	T91
1032	T145
1034	T145
1036	T145
1038	T145
1150	T138
1166	T138
1084	T138
1048N	T153
1052	T153
1260	T198
1269PZ	T198
1267TX	T205
35	T234
1370	T234
1390	T234
1719BMA8/S5	T236



T05 T06 T31



T52 T55 T80



T91 T145 T138 T153



T198 T205 T234 T236



5904VU/3T 2.295,00 059041203

Sortiment empfohlen in Kombination mit RSC24 - RSC24A - RSC24AXL - RSC24L/7 - RSC24L-CAB - C37 - C39 - C39T - C39SM - C39MD - RSC50 - RSC55 - C59

5904VU/4T

Werkzeugsortiment, 197-teilig, im festen Thermoformateinsatz aus ABS

► Universalsortimente

Stück / Beschreibung

- 1 Durchschläger Ø 4 mm
- 1 Splinttreiber Ø 4 mm
- 1 Körner Ø 4 mm
- 54 Sortiment mit 52 Sechskant - Schraubeinsätzen, 10 mm, und 2 Betätigungswerkzeugen
- 17 Ring-Maulschlüssel 6-7-8-10-11-12-13-14-16-17-18-19-21-22-24-27-30 mm
- 7 Doppelringschlüssel, tief gekröpft 6x7-8x9-10x11-12x13-14x15-16x17-18x19 mm
- 19 Sechskant-Steckschlüssel, 1/2" ○ 10-11-12-13-14-15-16-17-18-19
-20-21-22-23-24-26-27-30-32 mm
- 1 Verlängerung, 1/2" 125 mm
- 1 Verlängerung, 1/2" 250 mm
- 1 Kardangelenk, 1/2"
- 1 Gleitgriff, 1/2" 305 mm
- 1 Umschaltknarre, 1/2" ⊕
- 13 Sechskant-Steckschlüssel, 1/4" ○ 4-4,5-5-5,5-6-7-8-9-10-11-12-13-14 mm
- 6 Sechskant-Steckschlüssel 1/4" ○ 2,5-3-4-5-6-8 mm
- 1 Verlängerung, - 1/4" 50 mm
- 1 Verlängerung, - 1/4" 150 mm
- 1 Kardangelenk, 1/4"
- 1 Steckgriff, 1/4"
- 1 Gleitgriff, 1/4" 115 mm
- 1 Umschaltknarre, 1/4" ⊕
- 1 Diagonalseitenschneider \angle 160 mm
- 1 Zange mit halbrunden Backen, extralang, gerade = 180 mm
- 1 Verstellbare Zangen 250 mm
- 7 Schraubendreher für Schlitzschrauben ● 2,5x50 - 3x75 - 3,5x100 - 4x125 - 5,5x100 - 5,5x150
- 6,5x150 mm
- 6 Schraubendreher für Phillips®-Schrauben ⊕ PH0x60 - PH1x80 - PH1x120 - PH2x100 -
PH2x150 - PH3x150 mm
- 7 Stiftschlüssel mit Griff, für Torx®-Schrauben ⊕ T6-T7-T8-T9-T10-T15-T20
- 2 Flachmeißel, mit Hohlprofil 100-200 mm
- 1 Schlosserhammer, deutsches Modell 300 g
- 1 Hammer mit austauschbaren Kunststoffaufsätzen Ø 35 mm
- 7 Sechskant-Stiftschlüssel, gebogen, mit kugelförmigem Kopf, brüniert ○ 2,5-3-4-5-6-8-10 mm
- 1 Sechskant-Stiftschlüssel, gebogen ○ 12 mm
- 31 Sortiment mit 30 Schraubeinsätzen und magnetischer, schnellauslösender
Schraubeinsatzhalter, im Kunststoffkasten ⊕ ○ ⊕ ⊕ ⊕ ⊕
- 1 Einsatzhalter für Schraubeinsätze

Beta Nr.	TR
30	
31	
32	
867/C52	
42	T01
90	T40
920A	T83
920/21	T83
920/22	T83
920/25	T83
920/42	T83
920/45	T83
920/55	T83
900	T91
900ME	T91
900/20	T91
900/21	T91
900/25	T91
900BG/30	T91
900/42	T91
900/55	T91
1082	T156
1150	T156
1048N	T156
1201E	T211
1202E	T213
1207E/TX	T216
35	T234
1370	T234
1390	T234
96BP	T259
96N	T259
860MIX/A31	T259
895/1	T259



T01

T83

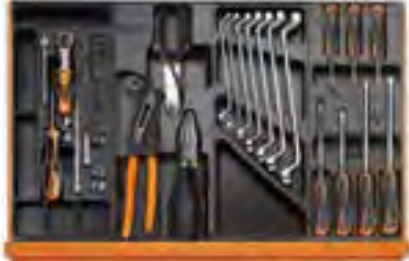

T91

T156

T40

T211



T213

T216

T234

T259



€



5904VU/4T

1.780,00 059241100

Sortiment empfohlen in Kombination mit RSC23T - RSC24 - RSC24A - RSC24AXL - RSC24L/7 - RSC24L-CAB - C37 - C39 - C39T - C39SM - C39MD - RSC55 - C59

5908VU/2T

Werkzeugsortiment, 161-teilig, im festen Thermoformateinsatz aus ABS

► Universalsortimente

Stück / Beschreibung

- 16 Ring-Maulschlüssel 6+21 mm
- 5 Ring-Maulschlüssel 22 - 24 - 27 - 30 - 32 mm
- 5 Splinttreiber Ø 2 - 3 - 4 - 5 - 6 mm
- 1 Körner Ø 4 mm
- 12 Doppelmaulschlüssel 6x7 - 8x9 - 10x11 - 12x13 - 14x15 - 16x17 - 18x19 - 20x22 - 21x23 - 24x26 - 27x29 - 30x32 mm
- 9 Sechskant-Stiftschlüssel, gebogen ○ 1,5 - 2 - 2,5 - 3 - 4 - 5 - 6 - 8 - 10 mm
- 7 Doppelringschlüssel, tief gekröpft 6x7-8x9-10x11-12x13-14x15-16x17-18x19 mm
- 6 Sechskant - Stiftschlüssel mit Griff ○ 2-2,5-3-4-5-6 mm
- 6 Stiftschlüssel mit Griff, für Torx®-Schrauben ⊕ T10-T15-T20-T25-T27-T30
- 19 Sechskant-Steckschlüssel, 1/2" ○ 10-11-12-13-14-15-16-17-18 - 19-20-21-22-23-24-26-27-30-32 mm
- 5 Sechskant-Steckschlüssel mit Innenvierkantantrieb, 1/2" ○ 5-6-8-10-12 mm
- 1 Verlängerung, schwenkbar - 1/2" 125 mm
- 1 Verlängerung, schwenkbar - 1/2" 250 mm
- 1 Kardangelen, 1/2"
- 1 Gleitgriff, 1/2" 305 mm
- 1 Umschaltknarre, 1/2" ⊕
- 13 Sechskant-Steckschlüssel, 1/4" ○ 4-4,5-5-5,5-6-7-8-9-10-11-12-13-14 mm
- 6 Sechskant-Steckschlüssel 1/4" ○ 2,5-3-4-5-6-8 mm
- 1 Verlängerung, - 1/4" 50 mm
- 1 Verlängerung, - 1/4" 150 mm
- 1 Kardangelen, 1/4"
- 1 Steckgriff, 1/4"
- 1 Gleitgriff, 1/4" 115 mm
- 1 Umschaltknarre, 1/4" ⊕
- 1 Diagonalseitenschneider für geringen Kraftaufwand ✂ 160 mm
- 1 Zange mit halbrunden Backen, extralang, gerade = 180 mm
- 1 Zangen mit halbrunden Backen, gerade ● 160 mm
- 1 Zangen mit geraden Backen für Sicherungsringe mit Innenspannung ○ 180 mm
- 1 Zangen mit um 90° gebogenen Backen für Sicherungsringe mit Innenspannung ○ 170 mm
- 1 Zangen mit geraden Backen für Sicherungsringe mit Außenspannung ● 175 mm
- 1 Zangen mit um 90° gebogenen Backen für Sicherungsringe mit Außenspannung ● 175 mm
- 1 Verstellbare Zangen 250 mm
- 1 Grijpzange, verstellbar 240 mm
- 7 Schraubendreher für Phillips®-Schrauben ● 2,5x50-3x75-3,5x100-4x125-5,5x100-5,5x150-6,5x150 mm
- 3 Schraubendreher für Phillips®-Schrauben ● 8x150-8x200-10x200 mm
- 2 Schraubendreher für Schlitzschrauben, extrakurze Klinge ● 4x30-6,5x30 mm
- 6 Schraubendreher für Phillips®-Schrauben ⊕ PH0x60-PH0x100-PH1x80-PH1x120-PH2x100-PH2x150 mm
- 2 Schraubendreher für Phillips®-Schrauben ⊕ PH3x150-PH4x200 mm
- 2 Schraubendreher für Phillips®-Schrauben, extrakurze Klinge ⊕ PH1x30-PH2x30 mm
- 2 Flachmeißel, mit Hohlprofil 100-200 mm
- 1 Schlosserhammer, deutsches Modell 300 g
- 1 Hammer mit auswechselbaren Kunststoffaufsätzen Ø 35 mm
- 1 Vierkantfeilen halbschlicht 200 mm
- 1 Dreieckfeilen, halbschlicht 200 mm
- 1 Flachfeilen halbschlicht 200 mm
- 1 Halbrundfeilen halbschlicht 200 mm
- 1 Rundfeilen halbschlicht 200 mm
- 1 Thermoformateinsätze für Kleinteile

Beta Nr.	TR
42	T05
42	T06
31	T31
32	T31
55	T31
96N/SC9	T31
90	T40
96T	T52
97TTX	T55
920A	T82
920ME	T82
920AN/125	T82
920AN/250	T82
920/25	T82
920/42	T82
920/55	T82
900	T91
900ME	T91
900/20	T91
900/21	T91
900/25	T91
900BG/30	T91
900/42	T91
900/55	T91
1084	T138
1150	T138
1166	T138
1032	T145
1034	T145
1036	T145
1038	T145
1048N	T153
1052	T153
1290	T170
1290	T171
1290N	T171
1292	T172
1292	T173
1292N	T173
35	T234
1370	T234
1390	T234
1719BMA...Q	T236
1719BMA...T	T236
1719BMA...P	T236
1719BMA...M	T236
1719BMA...R	T236
VP4	



5908VU/2T 2.620,00 059081136

Sortiment empfohlen in Kombination mit RSC23T - RSC24 mit 6-7-8 Schubladen - RSC24A - RSC24AXL - RSC24L/7 - RSC24L-CAB - RSC28 C37 mit 6-7-8 Schubladen - C39 mit 6-7-8 Schubladen - C39MD - C39SM - C59 - RSC50 - RSC55





5914VU/M

Werkzeugsortiment, 109-teilig, für Werkzeugtrolley C14, im Schaumstoffeinsatz aus EVA

► Universalsortimente

Stück / Beschreibung

31 Sortiment mit 30 Schraubeinsätzen und magnetischer, schnellauslösender

Schraubeinsatzhalter, im Kunststoffkasten    

1 Einsatzhalter für Schraubeinsätze

13 Sechskant-Steckschlüssel, 1/4"  4-4,5-5-5,5-6-7-8-9-10-11-12-13-14 mm

1 Verlängerung, - 1/4" 150 mm

1 Kardangelenk, 1/4"

1 Steckgriff, Außenvierkant 1/4"

1 Gleitgriff, 1/4"

1 Umschaltknarre, 1/4" 

16 Sechskant-Steckschlüssel, 1/2"  10-11-12-13-14-15-16-17-18-19-21-22-24-27-30-32 mm

1 Kardangelenk, 1/2"

1 Verlängerung, schwenkbar - 1/2"

1 Gleitgriff, 1/2"

1 Umschaltknarre, 1/2" 

16 Ring-Maulschlüssel 6-7-8-9-10-11-12-13-14-15-16-17-18-19-21-22 mm

9 Sechskant-Stiftschlüssel, gebogen 

1 Einmaulschlüssel, verstellbar 250 mm

1 Elektrikerschere, gerade Schneiden

1 Rollbandmaß 5 mt

1 Cutter

1 Verstellbare Zangen 250 mm

1 Diagonalseitenschneider \sphericalangle 160 mm

1 Zange mit halbrunden Backen, extralang, gerade \equiv 180 mm

1 Zangen mit halbrunden Backen, gerade  160 mm

3 Schraubendreher für Schlitzschrauben  3,5x100-5,5x125-6,5x150 mm

3 Schraubendreher für Phillips®-Schrauben  PH0x60-PH1x80-PH2x100 mm

Beta Nr. TR

860MIX/A31 MCT1

895/1 MCT1

900 MCT1

900/... MCT1

900/25 MCT1

900BG/30C MCT1

900/42 MCT1

900/55 MCT1

920A MCT1

920/25 MCT1

920AN/125 MCT1

920/42 MCT1

920/55 MCT1

42 MCT2

96/SC9 MCT2

111E MCT2

1128BMX MCT2

1692/5 MCT2

1771 MCT2

1048N MCT3

1082BM MCT3

1150BM MCT3

1166BM MCT3

1260 MCT3

1262 MCT3



MC T1



MC T2



MC T3

€



5914VU/M

1.265,00 059140112

Sortiment empfohlen in Kombination mit Art. C14 Anm.: Zum korrekten Schließen des oberen Moduls des Werkzeugtrolleys empfiehlt sich, die Werkzeuggestafel unter dem Deckel zu entfernen.

5988U/7M

Werkzeugsortiment, 215-teilig, im Schaumstoffeinsatz aus EVA

► Universalsortimente

Stück / Beschreibung

Beta Nr. TR



M01

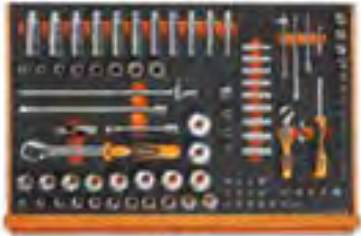

M100



M213



M33 M86 M136 M234

- 22 Ring-Maulschlüssel 6-7-8-9-10-11-12-13-14-15-16-17-18-19-20-21-22-24-27-30-32-36 mm
- 8 Doppelmaulschlüssel 6x7-8x9-10x11-12x13-14x15-16x17-18x19-20x22 mm
- 9 Sechskant-Stiftschlüssel, gebogen \odot 1,5+10 mm
- 7 Sechskant-Schraubeinsätze \odot 4-5-6-7-8-10-12 mm
- 7 Sechskant-Schraubeinsätze \odot 4-5-6-7-8-10-12 mm
- 5 Schraubeinsätze für Vielzahnschrauben (XZN[®]) \odot 5-6-8-10-12 mm
- 5 Schraubeinsätze für Vielzahnschrauben (XZN[®]) \odot 5-6-8-10-12 mm
- 7 Schraubeinsätze für Torx[®]-Schrauben \odot T20-T25-T30-T40-T45-T50-T55
- 6 Schraubeinsätze für Torx[®]-Schrauben \odot T25-T30-T40-T45-T50-T55
- 7 Schraubeinsätze für Sicherheitsschrauben Tamper Resistant Torx[®] \odot T20-T25-T30-T40-T45-T50-T55
- 1 Einsatzhalter für Schraubeinsätze Art. 867
- 1 Einsatzhalter für Schraubeinsätze Art. 867
- 1 Einsatzhalter für Schraubeinsätze
- 1 Einsatzhalter für Schraubeinsätze
- 1 Einsatzhalter für Schraubeinsätze
- 13 Sechskant-Steckschlüssel, 1/4" \odot 4-4,5-5-5,5-6-7-8-9-10-11-12-13-14 mm
- 9 Sechskant-Steckschlüssel, lange Ausführung \odot 5-6-7-8-9-10-11-12-13 mm
- 5 Sechskant-Steckschlüssel 1/4" \odot 3-4-5-6-7 mm
- 4 Schraubendrehereinsätze für Schlitzschrauben \bullet 0,8x4-1x5,5-1,2x6,5-1,2x8 mm
- 4 Schraubendrehereinsätze für Phillips[®]-Schrauben \oplus PH1-PH2-PH3-PH4
- 7 Steckschlüssel für Torx[®]-Schrauben \odot T10-T15-T20-T25-T27-T30-T40
- 1 Verlängerung, - 1/4" 50 mm
- 1 Verlängerung, - 1/4" 100 mm
- 1 Verlängerung, - 1/4" 150 mm
- 1 Kardangelenke, 1/4"
- 1 Steckgriff, 1/4"
- 1 Gleitgriff, 1/4"
- 1 Umschaltknarre, 1/4" \oplus
- 21 Sechskant-Steckschlüssel, 1/2" \odot 8-10-11-12-13-14-15-16-17-18-19-20-21-22-23-24-26-27-28-30-32 mm
- 1 Reduzierstück, Innenvierkant 1/2", Außenvierkant 3/8"
- 1 Kardangelenke, 1/2"
- 1 Verlängerung, schwenkbar - 1/2" 125 mm
- 1 Verlängerung, schwenkbar - 1/2" 250 mm
- 1 Gleitgriff, 1/2"
- 1 Umschaltknarre, 1/2" \oplus
- 8 Steckschlüssel mit Innenvierkantantrieb 1/2", für Torx[®]-Schrauben \odot 10-12-14-16-18-20-22-24 mm
- 11 Sechskant-Steckschlüssel, lange Ausführung \odot 10-12-13-14-15-16-17-18-19-21-22
- 1 Diagonalseitenschneider für geringen Kraftaufwand \blacktriangledown 160 mm
- 1 Zange mit halbrunden Backen, extralang, gerade \equiv 180 mm
- 1 Zangen mit halbrunden Backen, gerade \bullet 160 mm
- 6 Schraubendreher für Schlitzschrauben \bullet 2,5x50-3x75-4x100-5,5x125-6,5x150-8x200 mm
- 1 Schraubendreher für Schlitzschrauben, extrakurze Klinge \bullet 4x30 mm
- 4 Schraubendreher für Phillips[®]-Schrauben \oplus PH0x60-PH1x80-PH2x100-PH3x150 mm
- 1 Schraubendreher für Phillips[®]-Schrauben, extrakurze Klinge \oplus PH1X30 mm
- 12 Stiftschlüssel mit Griff, für Torx[®]-Schrauben \odot T6-T7-T8-T9-T10-T15-T20-T25-T27-T30-T40-T45
- 1 Schraubendreher mit Spannungsprüfer \bullet
- 2 Flachmeißel, mit Hohlprofil 100-200 mm
- 1 Schlosserhammer, deutsches Modell 300 g
- 1 Hammer mit auswechselbaren Kunststoffaufsätzen \varnothing 35 mm

42	M01
55	M33
96/SC9	M33
867PE	M86
867PEL	M86
867XZN	M86
867XZNL	M86
867TX	M86
867TXL	M86
867RTX	M86
867/1	M86
867/2	M86
895/1	M100
895/3	M100
895/6	M100
900	M100
900L	M100
900ME	M100
900LP	M100
900PH	M100
900TX	M100
900/20	M100
900/20L	M100
900/21	M100
900/25	M100
900BG/30	M100
900/42	M100
900/55	M100
920A	M100
920/15	M100
920/25	M100
920AN/125	M100
920AN/250	M100
920/42	M100
920/55	M100
920FTX	M100
920AL	M100
1084BM	M136
1150BM	M136
1166BM	M136
1201E	M213
1201EN	M213
1202E	M213
1202EN	M213
1207E/TX	M213
1253	M213
35	M234
1370	M234
1390	M234

€

5988U/7M 2.640,00 059881019

Sortiment empfohlen in Kombination mit RSC23T - RSC24 - RSC24A - RSC24A-XL - RSC24L - RSC24L/CAB - RSC28 - C37 - C39 - C39SM - C39MD - RSC50 - RSC55 - C59



5915VU/0

Werkzeugsortiment, 35teilig

► Universalsortimente

Stück / Beschreibung

- 1 Körner 4 mm
- 1 Flachmeißel, mit Hohlprofil 125 mm
- 8 Doppelmaulschlüssel 6x7-8x9-10x11-12x13-14x15-16x17-18x19-20x22 mm
- 7 Sechskant-Steckschlüssel \odot 1,5-2-2,5-3-4-5-6 mm
- 1 Einmaulschlüssel, verstellbar 150 mm
- 1 Verstellbare Zangen 250 mm
- 1 Diagonalseitenschneider, Griffe mit zweischichtigem Überzug aus rutschfestem PVC, Industrie-Finish \llcorner 160 mm
- 1 Elektrikerschere, gerade Schneiden
- 1 Universalzangen für geringen Kraftaufwand, Griffe mit zweischichtigem Überzug aus rutschfestem PVC, Industrie-Finish \equiv 180 mm
- 1 Zangen mit halbrunden Backen, extralang, gerade, innengeriffelt, Griffe mit zweischichtigem Überzug aus rutschfestem PVC, Industrie-Finish \bullet 160 mm
- 4 Schraubendreher für Schlitzschrauben \bullet 3x75-4x100-5,5x100-6,5x150 mm
- 3 Schraubendreher für Phillips®-Schrauben \oplus PH0x60-PH1x80-PH2x100 mm
- 1 Schlosserhammer, deutsches Modell 300 g
- 1 Rollbandmaß 3 m
- 1 Cutter 18 mm
- 1 Auto-Notfallmesser
- 1 LED-Taschenlampe, leuchtstark, aus robustem eloxiertem Aluminium, bis zu 500 Lumen

- | Beta Nr. |
|----------|
| 32 |
| 35 |
| 55 |
| 96/BGS7 |
| 111E |
| 1048N |
| 1082G |
| 1128BMX |
| 1150G |
| 1166G |
| 1201E |
| 1202E |
| 1370 |
| 1692/3 |
| 1771 |
| 1778SOS |
| 1833S |

5915VU/0

€



467,00 059151021

Sortiment empfohlen in Kombination mit C4 - C5 - C5S - C6T



5915VU/1

Werkzeugsortiment, 45teilig

► Universalsortimente

Stück / Beschreibung

- 2 Durchschläger \varnothing 2-3 mm
- 1 Körner \varnothing 4 mm
- 1 Flachmeißel 125-150 mm
- 1 Kreuzmeißel 150 mm
- 14 Ring-Maulschlüssel 6+14 - 17 - 19 - 21 - 22 - 24 mm
- 9 Sechskant-Stiftschlüssel, gebogen \odot 1,5 - 2 - 2,5 - 3 - 4 - 5 - 6 - 8 - 10 mm
- 1 Einmaulschlüssel, verstellbar 250 mm
- 1 Verstellbare Zangen 250 mm
- 1 Diagonalseitenschneider, Griffe mit zweischichtigem Überzug aus rutschfestem PVC, Industrie-Finish \llcorner 160 mm
- 1 Elektrikerschere, gerade Schneiden
- 1 Universalzangen für geringen Kraftaufwand, Griffe mit zweischichtigem Überzug aus rutschfestem PVC, Industrie-Finish \equiv 180 mm
- 1 Zangen mit halbrunden Backen, extralang, gerade, innengeriffelt, Griffe mit zweischichtigem Überzug aus rutschfestem PVC, Industrie-Finish \bullet 160 mm
- 4 Schraubendreher für Schlitzschrauben \bullet 3x75 - 4x100 - 5,5x100 - 6,5x150 mm
- 3 Schraubendreher für Phillips®-Schrauben \oplus PH0x60 - PH1x80 - PH2x100 mm
- 1 Schlosserhammer, deutsches Modell 300 g
- 1 Rollbandmaß 5 m
- 1 Cutter

- | Beta Nr. |
|----------|
| 30 |
| 32 |
| 34 |
| 36 |
| 42 |
| 96/SC9 |
| 111E |
| 1048N |
| 1082G |
| 1128BMX |
| 1150G |
| 1166G |
| 1201E |
| 1202E |
| 1370 |
| 1692 |
| 1771 |

5915VU/1

€



567,00 059151024

Sortiment empfohlen in Kombination mit C8 - C9 - C10 - C10S - C11 - CP15 - CP15L - C16 - CP17 - CP17L - C18



5915VU/2 Werkzeugsortiment, 49teilig

► Universalsortimente

Stück / Beschreibung

	Beta Nr.
8 6x7 - 8x9 - 10x11 - 12x13 - 14x15 16x17 - 18x19 - 20x22 mm	55/B8N
9 Sechskant-Stiftschlüssel, gebogen \odot 1,5 - 2 - 2,5 - 3 - 4 - 5 - 6 - 8 - 10 mm	96/SC9
13 Sechskant-Steckschlüssel, 1/4" \odot 4 - 4,5 - 5 - 5,5 - 6 - 7 - 8 - 9 - 10 - 11 - 12 - 13 - 14 mm	900
1 Verlängerung, - 1/4" 150 mm	900/21
1 Kardangelenke, 1/4"	900/25
1 Steckgriff, 1/4"	900B/G/30
1 Gleitgriff, 1/4"	900/42
1 Umschaltknarre, 1/4" \oplus	900/55
1 Verstellbare Zangen 250 mm	1048N
1 Elektrikerschere, gerade Schneiden	1128BMX
1 Universalzangen für geringen Kraftaufwand, Griffe mit zweischichtigem Überzug aus rutschfestem PVC, Industrie-Finish \equiv 180 mm	1150G
4 Schraubendreher für Schlitzschrauben \bullet 3x75 - 4x100 - 5,5x150 - 6,5x150 mm	1201E
3 Schraubendreher für Phillips®-Schrauben \oplus PH0x60 - PH1x80 - PH2x100 mm	1202E
1 Schlosserhammer, deutsches Modell 300 g	1370
1 Rollbandmaß 3 m	1692
1 Abbrechbare Klingen, 18 mm breit, 10 Stück, für Cutter Art. 1771, 1771BM, 1771HD	1771RL
1 Cutter 18 mm	1771

€

5915VU/2 494,00 059151027

Sortiment empfohlen in Kombination mit C7 - CP15 - C20 - C20L



5915VU/3 Werkzeugsortiment, 74-teilig

► Universalsortimente

Stück / Beschreibung

	Beta Nr.
1 Splinttreiber \varnothing 4 mm	31
1 Körner \varnothing 4 mm	32
1 Flachmeißel 150 mm	34
14 Ring-Maulschlüssel 6-7-8-10-11-12-13-14-15-16-17-19-22-24 mm	42
9 Sechskant-Stiftschlüssel, gebogen \odot 1,5+10 mm	96/SC9
3 Sechskant - Stiftschlüssel mit Griff \odot 4 - 5 - 6 mm	96T
1 Einmaulschlüssel, verstellbar 250 mm	111E
13 Sechskant-Steckschlüssel, 1/2" \odot 8+17 - 19 - 22 - 24 mm	920A
1 Verlängerung, 1/2" 125 mm	920/21
1 Verlängerung, 1/2" 255 mm	920/22
1 Kardangelenke, 1/2"	920/25
1 Gleitgriff, 1/2"	920/42
1 Umschaltknarre, 1/2" \oplus	920/55
8 Doppelsteckschlüssel, Sechskant - Köpfe, leichte Ausführung 6x7 - 8x9 - 10x11 - 12x13 - 14x15 - 16x17 - 18x19 - 20x22 mm	935
2 Drehstifte für Doppelsteckschlüssel	940
1 Verstellbare Zangen, durchgestecktes Gelenk 250 mm	1048VN
1 Gripszange, verstellbar 240 mm	1052
1 Diagonalseitenschneider für geringen Kraftaufwand, Griffe mit zweischichtigem Überzug aus rutschfestem PVC, Industrie-Finish € 160 mm	1084G
1 Elektrikerschere, gerade Schneiden	1128BMX
1 Universalzangen für geringen Kraftaufwand, Griffe mit zweischichtigem Überzug aus rutschfestem PVC, Industrie-Finish \equiv 180 mm	1150G
1 Zangen mit halbrunden Backen, extralang, gerade, innengeriffelt, Griffe mit zweischichtigem Überzug aus rutschfestem PVC, Industrie-Finish \bullet 160 mm	1166G
4 Schraubendreher für Schlitzschrauben \bullet 3x75 - 4x100 - 5,5x150 - 6,5x150 mm	1201E
3 Schraubendreher für Phillips®-Schrauben \oplus PH0x60 - PH1x80 - PH2x100 mm	1202E
1 Schlosserhammer, deutsches Modell 400 g	1370
1 Rollbandmaß 5 m	1692
1 Sägebogen	1726
1 Kunststoffölkanne mit Pumpe 150 cc	1754
1 Cutter	1771

€

5915VU/3 1.048,00 059151028

Sortiment empfohlen in Kombination mit C7 - C9 - C10 - C10S - C11 - CP15L - C16 - CP17 - CP17L - C19 - C19L - C20 - C20L



5915VU/4

Werkzeugsortiment, 80teilig

► Universalsortimente

Stück / Beschreibung

- 1 Splinttreiber Ø 4 mm
- 1 Körner Ø 4 mm
- 1 Flachmeißel 150 mm
- 15 Ring-Maulschlüssel 6-7-8-9-10-11-12-13-14-15-16-17-19-22-24 mm
- 9 Sechskant-Stiftschlüssel, gebogen ⌀ 1,5+10 mm
- 1 Einmaulschlüssel, verstellbar 250 mm
- 13 Sechskant-Steckschlüssel, 1/2" ⌀ 8+17 - 19 - 22 - 24 mm
- 1 Verlängerung, 1/2" 255 mm
- 1 Kardangelenk, 1/2"
- 1 Gleitgriff, 1/2"
- 1 Umschaltknarre, 1/2" Ⓞ
- 17 Doppelsteckschlüssel, abgewinkelt, 12kant x 6kant 6+22 mm
- 1 Verstellbare Zangen 250 mm
- 1 Gripzange, verstellbar 240 mm
- 1 Diagonalseitenschneider für geringen Kraftaufwand, Griffe aus Bimaterial, Industrie-Finish ⚡ 160 mm
- 1 Elektrikerschere, gerade Schneiden
- 1 Universalzangen für geringen Kraftaufwand, Griffe aus Bimaterial, Industrie-Finish = 180 mm
- 1 Zangen mit halbrunden Backen, extralang, gerade, innengeriffelt, Griffe aus Bimaterial, Industrie-Finish ● 160 mm
- 4 Schraubendreher für Schlitzschrauben ● 3x75 - 4x100 - 5,5x150 - 6,5x150 mm
- 3 Schraubendreher für Phillips®-Schrauben Ⓞ PH0x60 - PH1x80 - PH2x100 mm
- 1 Schlosserhammer, französisches Modell 32 mm
- 1 Rollbandmaß 5 m
- 1 Sägebogen
- 1 Kunststofffölkanna mit Pumpe 150 cc
- 1 Cutter

Beta Nr.

- 31
- 32
- 34
- 42
- 96/SC9
- 111E
- 920A
- 920/22
- 920/25
- 920/42
- 920/55
- 932/S17
- 1048N
- 1052
- 1084GBM
- 1128BMX
- 1150GBM
- 1166GBM
- 1201E
- 1202E
- 1370F
- 1692
- 1726
- 1754
- 1771

€

5915VU/4 1.355,00 059151045

Sortiment empfohlen in Kombination mit C20 - C20L



5915VU/5

Werkzeugsortiment, 111-teilig

► Universalsortimente

Stück / Beschreibung

- 1 Splinttreiber Ø 4 mm
- 1 Körner Ø 4 mm
- 1 Flachmeißel 150 mm
- 17 Ring-Maulschlüssel 6-7-8-9-10-11-12-13-14-15-16-17-18-19-20-21-22 mm
- 8 Doppelmaulschlüssel 6x7-8x9-10x11-12x13-14x15-16x17-18x19-20x22 mm
- 9 Sechskant - Stiftschlüssel, gebogen, mit kugelförmigem Kopf Ⓞ
- 1 Einmaulschlüssel, verstellbar 250 mm
- 39 11 Sechskant-Steckschlüssel, 20 Schraubeinsätze und 8 Betätigungswerkzeuge
- 13 11 Steckschlüssel und 2 Betätigungswerkzeuge
- 1 Verstellbare Zangen 250 mm
- 1 Gripzange, verstellbar 240 mm
- 1 Diagonalseitenschneider, Griffe mit zweischichtigem Überzug aus rutschfestem PVC, Industrie-Finish ⚡ 160 mm
- 1 Flechterzangen 220 mm
- 1 Elektrikerschere, gerade Schneiden
- 1 Universalzangen für geringen Kraftaufwand, Griffe mit zweischichtigem Überzug aus rutschfestem PVC, Industrie-Finish = 180 mm
- 1 Zangen mit halbrunden Backen, extralang, gerade, innengeriffelt, Griffe mit zweischichtigem Überzug aus rutschfestem PVC, Industrie-Finish ● 160 mm
- 4 Schraubendreher für Schlitzschrauben ● 3x75 - 4x100 - 5,5x150 - 6,5x150 mm
- 3 Schraubendreher für Phillips®-Schrauben Ⓞ PH0x60 - PH1x80 - PH2x100 mm
- 1 Schlosserhammer, deutsches Modell 300 g
- 1 Hammer mit auswechselbaren Kunststoffaufsätzen Ø 35 mm
- 1 Rollbandmaß 3 m
- 1 Feilen für normale Bearbeitung
- 1 Sägebogen 440 mm
- 1 Cutter 18 mm
- 1 LED-Inspektionslampe, aus robustem eloxiertem Aluminium

Beta Nr.

- 31
- 32
- 34
- 42
- 55/S8
- 96BPC/SC9
- 111E
- 900/C11
- 920A/C11
- 1048N
- 1052
- 1082G
- 1098
- 1128BMX
- 1150G
- 1166G
- 1201E
- 1202E
- 1370
- 1390
- 1692/3
- 1719BMA8/M
- 1726
- 1771BM
- 1833XS/2

€

5915VU/5 1.330,00 059151046

Sortiment empfohlen in Kombination mit C12 - C41S - C41H - C42S - C42H

5915VU/AS

Werkzeugsortiment, 68-teilig

► Universalsortimente

Stück / Beschreibung

- 1 Splinttreiber Ø 4 mm
- 1 Körner Ø 4 mm
- 1 Flachmeißel 150 mm
- 13 Ring-Maulschlüssel 1/4 - 5/16 - 3/8 - 7/16 - 1/2 - 9/16 - 5/8 - 11/16 - 3/4 - 13/16 - 7/8 - 15/16 - 1"
- 8 Doppelringschlüssel, tief gekröpft 1/4"-1"
- 9 ○ 3/64"-3/8"
- 1 Einmaulschlüssel, verstellbar 250 mm
- 11 Zwölfkant - Steckschlüssel, 1/2" ○ 3/8 - 7/16 - 1/2 - 9/16 - 5/8 - 11/16 - 3/4 - 13/16 - 7/8 - 15/16 - 1"
- 1 Verlängerung, 1/2" 125 mm
- 1 Verlängerung, 1/2" 255 mm
- 1 Kardangelen, 1/2"
- 1 Gleitgriff, 1/2"
- 1 Umschaltknarre, 1/2" ⊕
- 1 Verstellbare Zangen 250 mm
- 1 Gripzange, verstellbar 240 mm
- 1 Diagonalseitenschneider für geringen Kraftaufwand, Griffe aus Bimaterial, Industrie-Finish ≡ 160 mm
- 1 Elektrikerschere, gerade Schneiden
- 1 Universalzangen für geringen Kraftaufwand, Griffe aus Bimaterial, Industrie-Finish ≡ 180 mm
- 1 Zangen mit halbrunden Backen, extralang, gerade, innengeriffelt, Griffe aus Bimaterial, Industrie-Finish ● 160 mm
- 4 Schraubendreher für Schlitzschrauben ● 3x75 - 4x100 - 5,5x150 - 6,5x150 mm
- 3 Schraubendreher für Phillips®-Schrauben ⊕ PH0x60 - PH1x80 - PH2x100 mm
- 1 Schlosserhammer, deutsches Modell 300 g
- 1 Rollbandmaß 5 m
- 1 Sägebogen
- 1 Kunststoffkanne mit Pumpe 150 cc
- 1 Cutter

Beta Nr.
31
32
34
42AS
90AS/8
96AS/SC9
111E
920AS
920/21
920/22
920/25
920/42
920/55
1048N
1052
1084GBM
1128BMX
1150GBM
1166GBM
1201E
1202E
1370
1692
1726
1754
1771

€ 

5915VU/AS 1.152,00 059151032

Sortiment empfohlen in Kombination mit C10 - C20 - C20L

5927VU/M

Werkzeugsortiment, 108-teilig, im Schaumstoffeinsatz aus EVA

► Universalsortimente

Stück / Beschreibung

- 16 Ring-Maulschlüssel 6-7-8-9-10-11-12-13-14-15-16-17-18-19-21-22 mm
- 1 Diagonalseitenschneider für geringen Kraftaufwand ≡ 160 mm
- 9 Sechskant-Stiftschlüssel, gebogen ○ 1,5-2-2,5-3-4-5-6-8-10 mm
- 1 Zange mit halbrunden Backen, extralang, gerade ≡ 180 mm
- 1 Zangen mit halbrunden Backen, gerade ● 160 mm
- 3 Schraubendreher für Schlitzschrauben ● 3,5x100-5,5x150-6,5x150 mm
- 3 Schraubendreher für Phillips®-Schrauben ⊕ PH0x3x60-PH1x4,5x80-PH2x6x100 mm
- 31 Sortiment mit 30 Schraubeinsätzen und magnetischer, schnellauslösender Schraubeinsatzhalter, im Kunststoffkasten ● ⊕ ⊕ ⊕ ⊕ ⊕
- 1 Verstellbare Zangen 250 mm
- 1 Schlosserhammer, deutsches Modell 300 mm
- 1 Körner 4 mm
- 1 Kreuzmeißel 4 mm
- 13 Sechskant-Steckschlüssel, 1/4" ○ 4-4,5-5-5,5-6-7-8-9-10-11-12-13-14 mm
- 1 Verlängerung, - 1/4" 150 mm
- 1 Kardangelen, 1/4"
- 1 Steckgriff, Außenvierkant 1/4"
- 1 Gleitgriff, 1/4"
- 1 Umschaltknarre, 1/4" ⊕
- 16 Sechskant-Steckschlüssel, 1/2" ○ 10-11-12-13-14-15-16-17-18-19-21-22-24-27-30-32 mm
- 1 Kardangelen, 1/2"
- 1 Verlängerung, schwenkbar - 1/2" 125 mm
- 1 Gleitgriff, 1/4"
- 1 Umschaltknarre, 1/2" ⊕
- 1 Einsatzhalter für Schraubeinsätze

Beta Nr.	TR
42	MC10
1084BM	MC10
96SC9	MC10
1150BM	MC10
1166BM	MC10
1201E	MC10
1202E	MC10
860MIX/A31	MC20
1048N	MC20
1370	MC20
32	MC20
36	MC20
900	MC20
900/21	MC20
900/25	MC20
900BG/30C	MC20
900/42	MC20
900/55	MC20
920A	MC20
920/25	MC20
920AN/125	MC20
900/42	MC20
920/55	MC20
895/1	MC20

€ 

5927VU/M 1.134,00 059271021

Sortiment empfohlen in Kombination mit RSC22 - C27S - RSC23 - RSC23C

5938U/2T

Werkzeugsortiment, 210-teilig, im festen Thermoformateinsatz aus ABS

► Universalsortimente

Stück / Beschreibung

- 7 Schraubendreher für Schlitzschrauben ● 2,5x50 - 3x75 - 3,5x100 - 4x125
5,5x100 - 5,5x150 - 6,5x150 mm
- 6 Schraubendreher für Phillips®-Schrauben ● PH0x60-PH1x80-PH1x120-PH2x100-PH2x150-
PH3x150 mm
- 7 Stiftschlüssel mit Griff, für Torx®-Schrauben ○ T6-T7-T8-T9-T10-T15-T20
- 1 Zangen mit geraden Backen für Sicherungsringe mit Innenspannung ○ 180 mm
- 1 Zangen mit um 90° gebogenen Backen für Sicherungsringe mit Innenspannung ○ 170 mm
- 1 Zangen mit geraden Backen für Sicherungsringe mit Außenspannung ● 175 mm
- 1 Zangen mit um 90° gebogenen Backen für Sicherungsringe mit Außenspannung ● 175 mm
- 1 Verstellbare Zangen 250 mm
- 1 Gripzange, verstellbar 240 mm
- 1 Diagonalseitenschneider für geringen Kraftaufwand ≤ 160 mm
- 1 Zange mit halbrunden Backen, extralang, gerade = 180 mm
- 1 Zangen mit halbrunden Backen, gerade ● 160 mm
- 1 Schlüssel mit Einsatzhalter 1/4x5/16
- 13 Sechskant-Steckschlüssel, 1/4" ○ 4-4,5-5-5,5-6-7-8-9-10-11-12-13-14 mm
- 1 Umschaltknarre, 1/4" ⊕ 125 mm
- 1 Gleitgriff, 1/4" 115 mm
- 1 Steckgriff, 1/4" 176 mm
- 1 Kardangelenke, 1/4" 41 mm
- 1 Verlängerung, - 1/4" 150 mm
- 1 Einsatzhalter, mit Schnellanschluss und Griff 230 mm
- 5 Schraubeinsätze für Spannerschrauben ● 4-6-8-10-12 mm
- 8 Schraubeinsätze für Torq-Set®-Schrauben ● 0-1-2-3-4-5-6-8 mm
- 6 Schraubeinsätze für Tri-Wing®-Schrauben ● 1-2-3-4-5-6 mm
- 8 Schraubeinsätze für Sicherheitsschrauben Tamper Resistant Torx®
● T9-T10-T15-T20-T25-T27-T30-T40
- 11 Schraubeinsätze für Torx®-Schrauben ○ T6-T7-T8-T9-T10-T15-T20-T25-T27-T30-T40
- 3 Schraubeinsätze für Pozidriv®- und Supadriv®-Schrauben ● PZ1 - PZ2 - PZ3
- 4 Schraubeinsätze für Phillips®-Schrauben ● PH0 - PH1 - PH2 - PH3
- 8 Sechskant-Schraubeinsätze ○ 2 - 2,5 - 3 - 4 - 5 - 6 - 8 - 10 mm
- 7 Schraubeinsätze für Schlitzschrauben
● 0,5x3 - 0,6x4,5 - 0,8x5,5 - 1x5,5 - 1,2x6,5 - 1,2x8 - 1,6x8 mm
- 2 Flachmeißel, mit Hohlprofil 100 - 200 mm
- 1 Schlosserhammer, deutsches Modell 300 g
- 1 Hammer mit auswechselbaren Kunststoffaufsätzen Ø 35 mm
- 1 Rollbandmaß 5 m
- 1 Minisägebogen
- 1 Abbrechbare Klingen, 18 mm breit, 10 Stück, für Cutter Art. 1771, 1771BM, 1771HD
- 1 Cutter
- 19 Sechskant-Steckschlüssel, 1/2"
○ 10 - 11 - 12+19 - 20 - 21 - 22 - 23 - 24 - 26 - 27 - 30 - 32 mm
- 5 Sechskant-Steckschlüssel mit Innenvierkantantrieb, 1/2" ○ 5 - 6 - 8 - 10 - 12 mm
- 1 Verlängerung, 1/2" 125 mm
- 1 Verlängerung, 1/2" 255 mm
- 1 Kardangelenke, 1/2"
- 1 Gleitgriff, 1/2"
- 1 Umschaltknarre, 1/2" ⊕
- 1 Körner Ø 4 mm
- 6 Splinttreiber mit Griff 2-3-4-5-6-8 mm
- 17 Ring-Maulschlüssel 6-7-8-10-11-12-13-14-16-17-18-19-21-22-24-27-30 mm
- 8 Doppelpmaulschlüssel 6x7 - 8x9 - 10x11 - 12x13 - 14x15 - 16x17 - 18x19 - 20x22 mm
- 9 Sechskant-Stiftschlüssel, gebogen ○
- 6 Stiftschlüssel mit T-Griff, Sechskantprofil an drei Enden 2,5 - 3 - 4 - 5 - 6 - 8 mm
- 5 Feilen für normale Bearbeitung 200 mm
- 11 Sechskant - Stiftschlüssel mit Griff ○ 2 - 2,5 - 3 - 3,5 - 4 - 4,5 - 5 - 6 mm
- 4 Thermoformateinsätze
- 4 Thermoformateinsätze
- 4 Thermoformateinsätze

Beta Nr.	TR
1201E	T211
1202E	T213
1207E/TX	T216
1032	T145
1034	T145
1036	T145
1038	T145
1048N	T153
1052	T153
1084BM	T137
1150BM	T137
1166BM	T137
194	T85
900	T85
900/55	T85
900/42	T85
900BG/30	T85
900/25	T85
900/21	T85
851SR	T85
861SP	T85
861TQS	T85
861TRW	T85
861RTX	T85
861TX	T85
861PZ	T85
861PH	T85
861PE	T85
861LP	T85
35	T234
1370	T234
1390	T234
1692	T294
1725CR	T294
1771RL	T294
1771	T294
920A	T80
920ME	T80
920/21	T80
920/22	T80
920/25	T80
920/42	T80
920/55	T80
32	T239
31BM	T239
42	T01
55	T33
96/SC9	T33
951	T68
1719BMA8/S5	T236
96T	T50
VP-3SC	VP-3SC
VP-LS	VP-LS
VP-LD	VP-LD



€

5938U/2T 2.820,00 059381062

Sortiment empfohlen in Kombination mit C38



5957U-P

Werkzeugsortiment, 133teilig

► Universalsortimente

Stück / Beschreibung	Beta Nr.
6 Splinttreiber 2 + 8 mm	31/SP6
2 Durchschläger, 1 Körner, 3 Meißel mit Ständer	38/SP6
17 Ring-Maulschlüssel 6+22 - 24 - 27 - 30 mm	42/S17X
12 Doppelmaulschlüssel 6x7 + 30x32 mm	55/S12X
8 Sechskant - Stiftschlüssel mit Griff 2 + 10 mm	96T/S8
8 Stiftschlüsselsatz, 8teilig, gebogen, für Torx®-Schrauben ⚙ T9 + T40	97TX/SC8
1 Einmaulschlüssel, verstellbar 250 mm	111E
13 Sechskant - Steckschlüssel, 1/2", mit Halter ⌀ 10 + 22 mm	920A/SB13
8 Sechskant - Steckschlüssel, 1/2", mit Halter ⌀ 23 + 32 mm	920A/SB8
7 Schraubendrehereinsätze für Phillips®-Schrauben ●	920LH/SB7
⚙ 1,2x65 - 1,2x8 - 1,6x9 - 2x12mm - PH1-PH2-PH3	
1 Zangen mit geraden Backen für Sicherungsringe mit Innenspannung ⌀ 180 mm	1032
1 Zangen mit um 90° gebogenen Backen für Sicherungsringe mit Innenspannung ⌀ 170 mm	1034
1 Zangen mit geraden Backen für Sicherungsringe mit Außenspannung ● 175 mm	1036
1 Zangen mit um 90° gebogenen Backen für Sicherungsringe mit Außenspannung ● 175 mm	1038
1 Verstellbare Zangen 250 mm	1048N
1 Gripzange, verstellbar 240 mm	1052
1 Figureschere, amerikanisches Modell 250 mm	1112
1 Elektrikerschere, gerade Schneiden	1128BMX
8 2,5x50 - 3x75 - 4x100 - 5,5x125 - 6,5x150 - PH0 - PH1 - PH2	1263/D8
2 Schlosserhammer, deutsches Modell 300 - 600 g	1370
1 Hammer mit auswechselbaren Kunststoffaufsätzen 35	1390
1 Rollbandmaß 5 m	1692/5
1 Magnetheber, flexibel	1712E/2
1 Löffelschaber 200 mm	1717A
1 Dreikantschaber 200 mm	1717B
5 Feilen für normale Bearbeitung 200 mm	1719BMA8/S5
1 Metallölkanne mit Pumpe 200 cc	1751N
1 Cutter	1771BM
1 Verlängerung, 1/2" 125 mm	920/21
1 Verlängerung, 1/2" 250 mm	920/22
1 Kardangelenk, 1/2"	920/25
1 Gleitgriff, 1/2"	920/42
1 Umschaltknarre, 1/2" ⚙	920/55
1 Hebeleisen, gerade	963
1 Diagonalseitenschneider ⚡ 160 mm	1082BM
1 Diagonalseitenschneider für geringen Kraftaufwand ⚡ 160 mm	1084BM
1 Hebelvorschnneider, schwere Ausführung ⚡ 180 mm	1092V
1 Zange mit halbrunden Backen, extralang, gerade = 180 mm	1150BM
1 Zangen mit halbrunden Backen, gerade ● 160 mm	1166BM
1 Zangen mit halbrunden Backen, gebogen ● 160 mm	1168BM
2 Schraubendreher für Schlitzschrauben ● 8x200 - 10x200 mm	1260
1 Schraubendreher für Phillips®-Schrauben ⚙ PH3 8x150mm	1262
1 Schieblehre	1650
1 Sägebogen 420 mm	1725

€

5957U-P 2.940,00 059571004

Sortiment empfohlen in Kombination mit C57S A - C57S B - C57SP - RSC50 PS - RSC50 - C55PS - C55PSE - RSC55



5958U

Werkzeugsortiment, 85teilig

► Universalsortimente

Stück / Beschreibung	Beta Nr.
17 Ring-Maulschlüssel 6÷22 mm	42
12 Sechskant-Stiftschlüssel, gebogen \odot 2÷10 mm	96N/SC12
13 Sechskant - Steckschlüssel, 1/2", mit Halter \odot 10÷22 mm	920A/SB13
8 Sechskant - Steckschlüssel, 1/2", mit Halter \odot 23÷32 mm	920A/SB8
1 Verlängerung, 1/2" 125 mm	920/21
1 Verlängerung, 1/2" 255 mm	920/22
1 Kardangelenk, 1/2"	920/25
1 Gleitgriff, 1/2"	920/42
1 Umschaltknarre, 1/2" \otimes	920/55
1 Zangen mit geraden Backen für Sicherungsringe mit Innenspannung \odot 180 mm	1032
1 Zangen mit geraden Backen für Sicherungsringe mit Außenspannung \bullet 175 mm	1036
1 Verstellbare Zangen 250 mm	1048N
1 Gripzange, verstellbar 240 mm	1052
1 Diagonalseitenschneider für geringen Kraftaufwand ∇ 160 mm	1084BM
1 Elektrikerschere, gerade Schneiden	1128BMX
1 Zange mit halbrunden Backen, extralang, gerade \equiv 180 mm	1150BM
1 Zangen mit halbrunden Backen, gerade \bullet 160 mm	1166BM
7 Schraubendreher für Schlitzschrauben \bullet 3x75 - 3,5x100 - 4x125 - 5,5x150 - 6,5x150 - 8x200 - 10x200 mm	1260
4 Schraubendreher für Phillips®-Schrauben \oplus PH0x60 - PH1x80 - PH2x100 - PH3x150 mm	1262/S4
1 Schlosserhammer, deutsches Modell 300 g	1370
1 Hammer mit auswechselbaren Kunststoffaufsätzen \varnothing 35 mm	1390
1 Rollbandmaß 5 m	1692
5 Feilensatz, 5-teilig, halbschlicht, mit Griff 200 mm	1719BMA..S5
1 Sägebogen	1725
1 Kunststofffölkanne mit Pumpe 150 cc	1754
1 Cutter	1771

€

5958U 1.480,00 059581008

Sortiment empfohlen in Kombination mit C58P - C45PRO - RSC50 - RSC55



5990V1

Werkzeugsortiment, 44-teilig, für Werkzeugkoffer COMBO C99V1, im Schaumstoffeinsatz aus EVA

► Universalsortimente

Stück / Beschreibung

Stück / Beschreibung	Beta Nr.
9 Sechskant - Stiftschlüssel, gebogen, mit kugelförmigem Kopf ○	96BPC/SC9
1 Cutter 18 mm	1771
1 Verstellbare Zangen 250 mm	1048N
6 Satz aus 2 Durchschlägern, 1 Körner, 2 Flachmeißeln und 1 Kreuzmeißel, in Werkzeugrolle aus Polyester	38/B6N
3 Schraubendreher für Schlitzschrauben ● 3,5x100-5,5x125-6,5x150 mm	1260
3 Schraubendreher für Phillips®-Schrauben ⊕ PH0x60-PH1x80-PH2x100 mm	1262
1 Elektrikerschere, gerade Schneiden	1128BMX
16 Ring-Maulschlüssel 6-7-8-9-10-11-12-13-14-15-16-17-18-19-21-22 mm	42
1 Rollbandmaß 5 mt	1692/5
1 Schlosserhammer, deutsches Modell 300 g	1370
1 Diagonalseitenschneider, Griffe aus Bimaterial, Industrie-Finish ⚡ 160 mm	1082GBM
1 Universalzangen für geringen Kraftaufwand, Griffe aus Bimaterial, Industrie-Finish ≡ 180 mm	1150GBM

€

5990V1 685,00 059900001

Sortiment empfohlen in Kombination mit Art. C99V1



5990V3

Werkzeugsortiment, 116-teilig, für Werkzeugkoffer COMBO C99V3/2C, im Schaumstoffeinsatz aus EVA

► KFZ-Mechanik

Stück / Beschreibung

Stück / Beschreibung	Beta Nr.
5 Sechskant - Stiftschlüssel mit Griff	96T/S5P
1 Einmaulschlüssel, verstellbar 250 mm	111E
1 Steckgriff, 1/4"	900BG/30
1 Schraubendreher mit Spannungsprüfer ●	1253
1 Taschen-Wasserwaage mit V-förmiger Messfläche	1695XS
1 LED-Inspektionslampe, aus robustem eloxiertem Aluminium	1833XS/2
31 Sortiment mit 30 Schraubeinsätzen und magnetischer, schnellauslösender Schraubeinsatzhalter, im Kunststoffkasten ● ○ ⊕ ⊖	860MIX/A31
1 Einsatzhalter für Schraubeinsätze	895
12 Sechskant-Steckschlüssel, 1/4" ○ 4-4,5-5-5,5-6-7-8-9-10-11-12-13 mm	900
1 Verlängerung, - 1/4" 50 mm	900/20
1 Verlängerung, - 1/4" 100 mm	900/20L
1 Gleitgriff, 1/4"	900/42
1 Umschaltknarre mit Außenvierkanttrieb 1/4", 72-Zähne-Mechanismus ⊕	900/55Z
38 Elektronschraubendreher mit 36 austauschbaren 4 mm Bits und Magnetverlängerung	1256/C36-2
1 Hammer mit auswechselbaren Kunststoffaufsätzen Ø 35mm	1390
1 Kardangelenk, 1/4"	900/25
13 Sechskant-Steckschlüssel, 1/2" ○ 10-11-12-13-14-15-16-17-18-19-20-21-22 mm	920A
1 Verlängerung, 1/2" 125 mm	920/21
1 Verlängerung, 1/2" 255 mm	920/22
1 Kardangelenk, 1/2"	920/25
1 Gleitgriff, 1/2"	920/42
1 Umschaltknarre, 1/2" ⊕	920/55

€

5990V3 985,00 059900003

Sortiment empfohlen in Kombination mit Art. C99V3/2C



5980U/BIKE

Werkzeugsortiment, 90-teilig

► Fahrradreparaturen

Stück / Beschreibung	Beta Nr.
5 Ring-Maulschlüssel 8-9-10-13-14 mm	42
9 Sechskant-Stiftschlüssel, gebogen, mit kugelförmigem Kopf, brüniert ○ 1,5-2-2,5-3-4-5-6-8-10 mm	96BP/SC9
8 Sechskant - Stiftschlüssel mit Griff 2-2,5-3-4-5-6-8-10 mm	96T/S8
8 Stiftschlüssel mit Griff, für Torx®-Schrauben ○ T8-T10-T15-T20-T25-T27-T30-T40	97TTX/S8
1 Einmaulschlüssel, verstellbar, kurze Ausführung, mit überdimensionaler Öffnung, verchromt 170 mm	111CM
1 Rohrschneider für Kupfer und Leichtmetalle	334
1 Drehmomentschlüssel mit Signalgebung 2±10 Nm	605E
13 ○ 4-4,5-5-5,5-6-7-8-9-10-11-12-13-14 mm	900/SB13
1 Verlängerung, - 1/4"	900/21
1 Kardangelenk, 1/4"	900/25
1 Umschaltknarre, 1/4" Ⓢ	900/55
1 Diagonalseitenschneider, Griffe mit zweischichtigem Überzug aus rutschfestem PVC, Industrie-Finish 160 mm	1082G
1 Elektrikerschere, gerade Schneiden 145 mm	1128BM
1 Universalzangen für geringen Kraftaufwand, Griffe mit zweischichtigem Überzug aus rutschfestem PVC, Industrie-Finish 180 mm	1150G
1 Zangen mit halbrunden Backen, extralang, gerade, innengeriffelt, Griffe mit zweischichtigem Überzug aus rutschfestem PVC, Industrie-Finish 180 mm	1166G
7 3x75-4x125-5,5x150-6,5x150-PH0x60-PH1x80-PH2x100 mm	1203E/D
1 Schlosserhammer, deutsches Modell 300 g	1370
1 Hammer mit auswechselbaren Kunststoffaufsätzen Ø 35 mm	1390
1 Schieblehre 150 mm	1650
1 Rollbandmaß 3 m	1692/3
1 Flachfeilen halbschlicht 200 mm	1719BMA...P
1 Halbrundfeilen halbschlicht 200 mm	1719BMA...M
1 Rundfeilen halbschlicht 200 mm	1719BMA...R
1 Sägebogen 300 mm	1725
1 Cutter	1771
1 Kettenverschleißanzeige 120 mm	3935
1 Zange für Kettenschloss 170 mm	3937
7 Satz 7 einfache Konusschlüssel 13-14-15-16-17-18-19 mm	3952/S7
1 Pedalschlüssel 15 mm	3953
1 Speichenzieher, schwarz, 3,2 mm □	3961 3,2
1 Speichenzieher, grün, 3,3 mm □	3961 3,3
1 Speichenzieher, rot, 3,5 mm □ 3	3961 3,5
1 Profi-Speichenzieher, 3,2 - 4,0 mm □ 3,2 - 4,0 mm	3961U
1 Schlüssel Ritzelpeitsche Kettenabnehmer 289 mm	3967
1 Reifenheber 200 mm	3969
3 Kit 3 Reifenheber, aus Kunststoff 113 mm	3969K3
1 Hebel zum Zurückziehen von Scheibenbremsenbelag 222 mm	3991
1 Schlüssel zum Richten von Bremscheiben 234 mm	3992

€

5980U/BIKE 1.760,00 059801040

Sortiment empfohlen in Kombination mit C16 - CP17 - CP17L - C20L

5980U/BIKE-M

Werkzeugsortiment, 106-teilig, für die Reparatur und Wartung von Fahrrädern

► Fahrradreparaturen

Stück / Beschreibung

Stück	Beschreibung	Beta Nr.	TR
16	Ring-Maulschlüssel 6-7-8-9-10-11-12-13-14-15-16-17-18-19-20-21 mm	42	M05
8	Sechskant - Stiftschlüssel mit Griff 2-2,5-3-4-5-6-7-8 mm	96T	M50
5	Stiftschlüssel mit Griff, für Torx®-Schrauben TX10-TX15-TX20-TX25-TX30	97TTX	M55
1	Diagonalseitenschneider für geringen Kraftaufwand 160 mm	1084	M137
1	Zange mit halbrunden Backen, extralang, gerade 160 mm	1150	M137
1	Zangen mit halbrunden Backen, gerade 160 mm	1166	M137
6	Schraubendreher für Schlitzschrauben 2,5x50-3x75-4x100-5,5x125-6,5x150-8x200 mm	1201E	M213
1	Schraubendreher für Schlitzschrauben, extrakurze Klinge 4x30 mm	1201EN	M213
4	Schraubendreher für Phillips®-Schrauben PH0x60-PH1x80-PH2x100-PH3x150 mm	1202E	M213
1	Schraubendreher für Phillips®-Schrauben, extrakurze Klinge 4,5x30 mm	1202EN	M213
12	Stiftschlüssel mit Griff, für Torx®-Schrauben TX6-TX7-TX8-TX9-TX10-TX15-TX20-T25-TX27-TX30-TX40-TX45	1207E/TX	M213
1	Schraubendreher mit Spannungsprüfer	1253	M213
1	Schlosserhammer, deutsches Modell 300 g	1370	M234
1	Hammer mit auswechselbaren Kunststoffaufsätzen 35 mm	1390	M234
2	Flachmeißel, mit Hohlprofil 100-200 mm	35	M234
1	Feilensatz, 5-teilig, halbschlicht, mit Griff 200 mm	1719BMA..S5	M236
1	Rollbandmaß 5 m	1692	M294
1	Minisägebogen 250 mm	1725CR	M294
1	Cutter	1771	M294
1	Abbrechbare Klingen, 18 mm breit, 10 Stück, für Cutter Art. 1771, 1771BM, 1771HD	1771RL	M294
1	Profi-Kettenwerkzeug kompatibel mit Ketten von 5 bis 11 Gängen	3932U	M400
1	Kettenverschleißanzeige	3935	M400
1	Zange für Kettenschloss	3937	M400
7	Einfacher Konusschlüssel 13-14-15-16-17-18-19 mm	3952	M400
1	Speichenzieher, schwarz, 3,2 mm □ 3,2 mm	3961 3,2	M400
1	Speichenzieher, grün, 3,3 mm □ 3,3 mm	3961 3,3	M400
1	Speichenzieher, rot, 3,5 mm □ 3,5 mm	3961 3,5	M400
1	Profi-Speichenzieher, 3,2 - 4,0 mm □ 3,2-4,0 mm	3961U	M400
1	Reifenheber	3969	M400
1	Kit 3 Reifenheber, aus Kunststoff	3969K3	M400
1	Abzieher Steckschlüssel für Tretlager mit 16 Kerben 39 mm	3973/1	M400
1	Abzieher Steckschlüssel für Tretlager mit 16 Kerben 41 mm	3973/2	M400
1	Abzieher Steckschlüssel für Tretlager mit 16 Kerben 46 mm	3973/3	M400
1	Abzieher Steckschlüssel für Tretlager mit 20 Kerben, mit Zentralstift, vernickelt 31,5 mm	3973/4	M400
1	Abzieher Schlüssel für 4-Gang-Freilauf BMX 35 mm	3984/1	M400
1	Abzieher Schlüssel für Freilauf Shimano 22,8 mm	3984/2	M400
1	Abzieher Schlüssel für Kassetten-Freilauf Shimano mit Führungsstift 23,5 mm	3984/3	M400
1	Abzieher Schlüssel für Freilauf Campagnolo mit Führungsstift 23 mm	3984/4	M400
1	Hebel zum Zurückziehen von Scheibenbremsenbelag	3991	M400
1	Schlüssel zum Richten von Bremsscheiben	3992	M400
1	Schaltauge-Richtwerkzeug	3921	M401
1	Tretkurbelabzieher	3948	M401
1	Pedalschlüssel	3953	M401
2	Maulschlüssel für Universal-Steuersätze 30x32-32x36 mm	3955	M401
1	Schlüssel Ritzelpeitsche Kettenabnehmer	3967	M401
1	Schlüssel für Kunststoffschraube Shimano	3971	M401



M05 M50 M55



M137 M234 M236 M294



M213



M400



M401

€

5980U/BIKE-M 2.320,00 059801050

5988H/7M

Werkzeugsortiment, 333-teilig, im Schaumstoffeinsatz aus EVA

► KFZ-Mechanik

Stück / Beschreibung

Beta Nr. TR



M125



M25



M105



M166



M231



M62



M78

- 13 Sechskant-Steckschlüssel, lange Ausführung ○ 8-9-10-11-12-13-14-15-16-17-19-21-22 mm
- 16 Sechskant-Steckschlüssel, lange Ausführung ○ 10-12-13-14-15-16-17-18-19-21-22-23-24-27-30-32 mm
- 7 Steckschlüssel mit Innenvierkanttrieb 1/2", für Torx®-Schrauben ○ E12-E14-E16-E18-E20-E22-E24
- 10 Farbige Sechskant-Schraubeinsätze 1/2" ○ 5-6-6L-7-8-8L-10-10L-12-12L mm
- 13 Steckschlüssel mit Innenvierkanttrieb 1/2", für Torx®-Schrauben ○ T20-T25-T27-T30-T30L-T40-T40L-T45-T50-T50L-T55-T60-T60L
- 8 Steckschlüssel für Vielzahnsschrauben (XZN®) ○ 5-6-6-6L-8-8L-10-10L-12L mm
- 18 Ring-Maulschlüssel 6-7-8-9-10-11-12-13-14-15-16-17-18-19-21-22-24-27 mm
- 1 Doppelringsschlüssel, tief gekröpft 6x7-8x9-10x11-12x13-14x15x16x17-18x19 mm
- 1 Adapter mit Schnellanschluss 1/4" für 10 mm Knarrenschlüssel
- 1 Adapter mit Schnellanschluss 3/8" für 13 mm Knarrenschlüssel
- 1 Adapter mit Schnellanschluss 1/2" für 19 mm Knarrenschlüssel
- 12 Ring-Maulschlüssel mit Umschaltknarre 8-9-10-11-12-13-14-15-16-17-18-19 mm
- 9 Sechskant - Stiftschlüssel, gebogen, mit kugelförmigem Kopf ○ 1,5-2-2,5-3-4-5-6-8-10 mm
- 1 Einsatzhalter für Schraubeinsätze ○ 1/4-□1/4
- 1 Einsatzhalter für Schraubeinsätze ○ 1/4-□3/8
- 1 Einsatzhalter für Schraubeinsätze ○ 5/16-□1/2
- 13 Sechskant-Steckschlüssel, 1/4" ○ 4-4,5-5-5,5-6-7-8-9-10-11-12-13-14 mm
- 9 Sechskant-Steckschlüssel, lange Ausführung ○ 5-6-7-8-9-10-11-12-13 mm
- 4 Schraubendrehereinsätze für Schlitzschrauben ● 0,8x4-1x5,5-1,2x6,51,2x8 mm
- 5 Sechskant-Steckschlüssel 1/4" ○ 3-4-5-6-7 mm
- 4 Schraubendrehereinsätze für Phillips®-Schrauben ● PH1-PH2-PH3-PH4
- 7 Steckschlüssel für Torx®-Schrauben ○ T10-T15-T20-T25-T27-T30-T40
- 1 Verbindungsstück, Innenvierkant 1/4", Außenvierkant 3/8" □1/4-■3/8
- 3 Verlängerung, - 1/4" 50-100-150 mm
- 1 Kardangelenk, 1/4"
- 1 Gleitgriff, 1/4"
- 1 Umschaltknarre, 1/4" ⊕
- 1 Steckgriff, 1/4"
- 17 Sechskant - Steckschlüssel 3/8" ○ 6-7-8-9-10-11-12-13-14-15-16-17-18-19-20-21-22 mm
- 1 Reduzierstück, Innenvierkant 3/8", Außenvierkant 1/4" □3/8-■1/4
- 1 Reduzierstück, Außenvierkant 1/2", Innenvierkant 3/8" □3/8-■1/2
- 1 Verlängerung - 3/8" 125 mm
- 1 Verlängerung - 3/8" 250 mm
- 1 Kardangelenk, Innen- und Außenvierkant 3/8"
- 1 Gleitgriff, Außenvierkant 3/8"
- 1 Umschaltknarre mit Außenvierkanttrieb 3/8" ⊕
- 21 Sechskant-Steckschlüssel, 1/2" ○ 8-10-11-12-13-4-15-16-17-18-19-20-21-22-23-24-26-27-28-30-32 mm
- 2 Verlängerung, schwenkbar - 1/2" 125-250 mm
- 1 Reduzierstück, Innenvierkant 1/2", Außenvierkant 3/8" □1/2-■3/8
- 1 Kardangelenk, 1/2"
- 1 Gleitgriff, 1/2"
- 1 Umschaltknarre, 1/2" ⊕
- 3 Zündkerzeneinsätze, 3/8" ○ 16-17,8-20,8 mm
- 31 Sortiment mit 30 Schraubeinsätzen und magnetischer, schnellauslösender Schraubeinsatzhalter, im Kunststoffkasten ● ○ ⊕ ⊗ ⊙
- 1 Verstellbare Zangen 250 mm
- 1 Diagonalseitenschneider ≤ 160 mm
- 1 Zange mit halbrunden Backen, extralang, gerade = 180 mm
- 1 Flachzangen mit geraden Backen = 160 mm
- 5 Schraubendreher für Phillips®-Schrauben ● 3x75-4x100-5,5x100-6,5x150-8x150 mm
- 1 Schraubendreher für Schlitzschrauben, extrakurze Klinge ● 6,5x30 mm
- 3 Schraubendreher für Phillips®-Schrauben ● PH1-PH2-PH3
- 1 Schraubendreher für Phillips®-Schrauben, extrakurze Klinge ● PH2
- 4 Stiftschlüssel mit Griff, für Torx®-Schrauben ○ T20-T25-T27-T30
- 6 Splinttreiber 2-3-4-5-6-8 mm
- 1 Körner 4 mm
- 3 Flachmeißel 125-150-75 mm
- 1 Kreuzmeißel 125 mm
- 2 Schlosserhammer, deutsches Modell 500-1000 g
- 1 Teleskopmagnetheber mit flexiblen Kopf
- 1 Hammer mit austauschbaren Kunststoffaufsätzen Ø 35 mm
- 1 Rollbandmaß 5 m
- 1 Zangen mit geraden Backen für Sicherungsringe mit Innenspannung ○ 180 mm
- 1 Zangen mit um 90° gebogenen Backen für Sicherungsringe mit Innenspannung ○ 170 mm
- 1 Zangen mit geraden Backen für Sicherungsringe mit Außenspannung ● 175 mm
- 1 Zangen mit um 90° gebogenen Backen für Sicherungsringe mit Außenspannung ● 175 mm
- 1 Klappmesser ● 140 mm
- 1 Diagonalseitenschneider für normalen Schnitt ≤ 125 mm
- 4 Elektronikschraubendreher für Gewindestifte mit Schlitz ● 2,0-2,5-3,0-3,5 mm
- 2 Elektronikschraubendreher für Phillips®-Schrauben ● 0-00
- 9 Stiftschlüssel mit Griff, für Torx®-Schrauben ○ T10-T15-T20-T25-T27-T30-T40-T45-T50
- 1 Gripzange, verstellbar 240 mm
- 1 Gripzange, verstellbar lange Backen 175 mm
- 1 Kunststoffzangen für Leitungs- und Muffenverschlüsse
- 1 Kunststoffzange für Leitungs- und Muffenverschlüsse
- 1 Kunststoffzange für Leitungs- und Muffenverschlüsse
- 1 Schiebellehre
- 1 Fühlerlehre
- 1 Schaber für Dichtungen
- 7 Zwölfkant-Doppelgelenksteckschlüssel 6x7-8x9-10x11-12x13-14x15-16x17-18x19 mm
- 1 Gelenkgriff, Außenvierkant 1/2"
- 1 Hebeleisen mit Griff 450 mm
- 1 Inspektionsspiegel, teleskopisch 670 mm
- 1 Feilen für normale Bearbeitung 200 mm
- 1 Feilen für normale Bearbeitung 200 mm
- 1 Feilen für normale Bearbeitung 200 mm
- 1 Feilen für normale Bearbeitung 200 mm
- 1 Feilen für normale Bearbeitung 200 mm
- 1 Feilen für normale Bearbeitung 200 mm
- 1 Stahldrahtbürste

- 910AL M125
- 920AL M125
- 920FTX M125
- 920PE M125
- 920TX M125
- 920XZN M125
- 42 M25
- 90 M25
- 123Q1/4 M25
- 123Q3/8 M25
- 123Q1/2 M25
- 142 M25
- 96BPC/SC9 M105
- 895/1 M105
- 895/3 M105
- 895/6 M105
- 900 M105
- 900L M105
- 900LP M105
- 900ME M105
- 900PH M105
- 900TX M105
- 900/16 M105
- 900/... M105
- 900/25 M105
- 900/42 M105
- 900/55 M105
- 900BG/30 M105
- 910A M105
- 910/15 M105
- 910/16 M105
- 910/21 M105
- 910/22 M105
- 910/25 M105
- 910/42 M105
- 910/55 M105
- 920A M105
- 920AN M105
- 920/15 M105
- 920/25 M105
- 920/42 M105
- 920/55 M105
- 956E M105
- 860MIX/A31 M166
- 1048N M166
- 1082BM M166
- 1150BM M166
- 1162BM M166
- 1290 M166
- 1290N M166
- 1292 M166
- 1292N M166
- 1297TX M166
- 31 M231
- 32 M231
- 34 M231
- 36 M231
- 1370 M231
- 1712TF M231
- 1390 M231
- 1692 M125
- 1032 M62
- 1034 M62
- 1036 M62
- 1038 M62
- 1177BM M62
- 1188BM M62
- 1257LP M62
- 1257PH M62
- 97TTX M62
- 1052 M78
- 1058 M78
- 1481PL/A M78
- 1481PL/B M78
- 1481PL/C M78
- 1650 M78
- 1708/20 M78
- 1716P M78
- 80 M78
- 920/36A M78
- 965 M78
- 1715 M231
- 1719BMA8/M M231
- 1719BMA8/P M231
- 1719BMA8/Q M231
- 1719BMA8/R M231
- 1719BMA8/T M231
- 1737NX M231

€



5988H/7M 6.030,00 059881087

Sortiment empfohlen in Kombination mit RSC24 mit 8 Schubladen - RSC24/A mit 8 Schubladen - C37 mit 8 Schubladen - C39 mit 8 Schubladen - RSC24A-XL - RSC28 - C59B - RSC50 C8 - RSC50 M8 - C55C8 - C55M8

5988L/4M

Werkzeugsortiment, 273-teilig, im Schaumstoffeinsatz aus EVA

► KFZ-Mechanik

Stück / Beschreibung



M105



M125



M25



M166

Stück / Beschreibung	Beta Nr.	TR
13 Sechskant-Steckschlüssel, 1/4" ○ 4-4,5-5-5,5-6-7-8-9-10-11-12-13-14 mm	900	M105
9 Sechskant-Steckschlüssel, lange Ausführung ○ 5-6-7-8-9-10-11-12-13 mm	900L	M105
9 Sechskant - Stiftschlüssel, gebogen, mit kugelförmigem Kopf ○ 1,5-2-2,5-3-4-5-6-8-10 mm	96BPC/SC9	M105
1 Einsatzhalter für Schraubeinsätze	895/1	M105
1 Einsatzhalter für Schraubeinsätze	895/3	M105
1 Einsatzhalter für Schraubeinsätze	895/6	M105
5 Sechskant-Steckschlüssel 1/4" ○ 3-4-5-6-7 mm	900ME	M105
4 Schraubendrehereinsätze für Schlitzschrauben ● 0,8x4-1x5,5-1,2x6,5-2x8 mm	900LP	M105
4 Schraubendrehereinsätze für Phillips®-Schrauben ● PH1-PH2-PH3-PH4	900PH	M105
7 Steckschlüssel für Torx®-Schrauben ○ T10-T15-T20-T25-T27-T30-T40	900TX	M105
1 Verbindungsstück, Innenvierkant 1/4", Außenvierkant 3/8" □ 1/4 - ■ 3/8	900/16	M105
3 Verlängerung, - 1/4" 50-100-150 mm	900/...	M105
1 Kardangelenke, 1/4"	900/25	M105
1 Steckgriff, 1/4"	900BG/30	M105
1 Gleitgriff, 1/4"	900/42	M105
1 Umschaltknarre, 1/4" ⊕	900/55	M105
17 Sechskant - Steckschlüssel 3/8" ○ 6-7-8-9-10-11-12-13-14-15-16-17-18-19-20-21-22 mm	910A	M105
1 Reduzierstück, Innenvierkant 3/8", Außenvierkant 1/4" □ 3/8 - ■ 1/4	910/15	M105
1 Reduzierstück, Außenvierkant 1/2", Innenvierkant 3/8" □ 3/8 - ■ 1/2	910/16	M105
1 Verlängerung - 3/8" 125 mm	910/21	M105
1 Verlängerung - 3/8" 250 mm	910/22	M105
1 Kardangelenke, Innen - und Außenvierkant 3/8"	910/25	M105
1 Gleitgriff, Außenvierkant 3/8"	910/42	M105
1 Umschaltknarre mit Außenvierkanttrieb 3/8" ⊕	910/55	M105
17 Sechskant-Steckschlüssel, 1/2" ○ 8-10-11-12-13-14-15-16-17-18-19-20-21-22-23-24-26-27-28-30-32 mm	920A	M105
1 Reduzierstück, Innenvierkant 1/2", Außenvierkant 3/8" □ 1/2 - ■ 3/8	920/15	M105
1 Kardangelenke, Innen - und Außenvierkant 3/8"	910/25	M105
2 Verlängerung, schwenkbar - 1/2" 125 - 250 mm	920AN	M105
1 Gleitgriff, 1/2"	920/42	M105
1 Umschaltknarre, 1/2" ⊕	920/55	M105
3 Zündkerzeneinsätze, 3/8" ○ 16-17-8-20,8 mm	956E	M105
13 Sechskant-Steckschlüssel, lange Ausführung ○ 8-9-10-11-12-13-14-15-16-17-19-21-22 mm	910AL	M125
10 Farbige Sechskant-Schraubeinsätze 1/2" ○ 5-6-6L-7-8-8L-10-10L-12-12L mm	920PE	M125
7 Steckschlüssel mit Innenvierkanttrieb 1/2", für Torx®-Schrauben ○ E12-E14-E16-E18-E20-E22-E24	920FTX	M125
13 Steckschlüssel mit Innenvierkanttrieb 1/2", für Torx®-Schrauben ○ T20-T25-T27-T30-T30L-T40-T40L-T45-T50-T50L-T55-T60-T60L	920TX	M125
8 Steckschlüssel für Vielzahnschrauben (XZN®) ○ 5-6-6L-8-8L-10-10L-12L mm	920XZN	M125
16 Sechskant-Steckschlüssel, lange Ausführung ○ 10-12-13-14-15-16-17-18-19-21-22-23-24-27-30-32 mm	920AL	M125
1 Rollbandmaß 5 m	1692/5	M125
18 Ring-Maulschlüssel 6-7-8-9-10-11-12-13-14-15-16-17-18-19-21-22-24-27 mm	42	M25
7 Doppelringschlüssel, tief gekröpft 6x7-8x9-10x11-12x13-14x15-16x17-18x19 mm	90	M25
1 Adapter mit Schnellanschluss 1/4" für 10 mm Knarrenschlüssel	123Q1/4	M25
1 Adapter mit Schnellanschluss 3/8" für 13 mm Knarrenschlüssel	123Q3/8	M25
1 Adapter mit Schnellanschluss 1/2" für 19 mm Knarrenschlüssel	123Q1/2	M25
12 Ring-Maulschlüssel mit Umschaltknarre 8-9-10-11-12-13-14-15-16-17-18-19 mm	142	M25
31 Sortiment mit 30 Schraubeinsätzen und magnetischer, schnellauslösender Schraubeinsatzhalter, im Kunststoffkasten ● ○ ⊕ ⊕ ⊕ ⊕	860MIX/A31	M166
1 Verstellbare Zangen 250 mm	1048N	M166
1 Diagonalseitenschneider ✂ 160 mm	1082BM	M166
1 Zange mit halbrunden Backen, extralang, gerade = 180 mm	1150BM	M166
1 Flachzangen mit geraden Backen = 160 mm	1162BM	M166
5 Schraubendreher für Phillips®-Schrauben ● 3x75-4x100-5,5x100-6,5x150-8x150 mm	1290	M166
1 Schraubendreher für Schlitzschrauben, extrakurze Klinge ● 6,5x30 mm	1290N	M166
3 Schraubendreher für Phillips®-Schrauben ● 4,5x80-6x100-8x150 mm	1292	M166
1 Schraubendreher für Phillips®-Schrauben, extrakurze Klinge ● 6x30 mm	1292N	M166
4 Stiftschlüssel mit Griff, für Torx®-Schrauben ○ T20-T25-T27-T30	1297TX	M166

5988L/4M

€ 4.250,00 059881088

Sortiment empfohlen in Kombination mit RSC24 - RSC24A - RSC24A-XL - RSC24L - RSC24L/CAB - C37 - C39 - C39T - C39SM - C39MD - RSC50 - RSC55 - C59

5988U6/M

Werkzeugsortiment, 214-teilig, im Schaumstoffeinsatz aus EVA

► Universalsortimente

Stück / Beschreibung

Beta Nr. TR

22	Ring-Maulschlüssel 6-7-8-9-10-11-12-13-14-15-16-17-18-19-20-21-22-24-27-30-32-36 mm	42	M01
11	Doppelmaulschlüssel 6x7-8x9-10x11-12x13-14x15-16x17-18x19-20x22-21x23-24x27-30x32 mm	55	M30
11	Doppelringschlüssel, tief gekröpft 6x7-8x9-10x11-12x13-14x15-16x17-18x19-20x22-21x23-24x27-30x32 mm	90	M30
9	Sechskant - Stiftschlüssel, gebogen, mit kugelförmigem Kopf \odot 1,5-2-2,5-3-4-5-6-8-10 mm	96BPC/SC9	M30
6	Schraubendreher für Schlitzschrauben \bullet 2,5x50-3x75-4x100-5,5x125-6,5x150-8x200 mm	1201E	M213
1	Schraubendreher für Schlitzschrauben, extrakurze Klinge \bullet 4x30 mm	1201EN	M213
4	Schraubendreher für Phillips®-Schrauben \oplus PH0x60-PH1x80-PH2x100-PH3x150 mm	1202E	M213
1	Schraubendreher für Phillips®-Schrauben, extrakurze Klinge \oplus PH1x30 mm	1202EN	M213
12	Stiftschlüssel mit Griff, für Torx®-Schrauben \odot T6-T7-T8-T9-T10-T15-T20-T25-T27-T30-T40-T45	1207ETX	M213
1	Schraubendreher mit Spannungsprüfer \bullet	1253	M213
3	Durchschläger \varnothing 2-3-4 mm	30	M230
6	Splinttreiber \varnothing 2-3-4-5-6-8 mm	31	M230
1	Körner \varnothing 4 mm	32	M230
1	Flachmeißel 150 mm	34	M230
2	Flachmeißel, mit Hohlprofil 200-250 mm	35	M230
1	Kreuzmeißel 125 mm	36	M230
1	Schlosserhammer, deutsches Modell 500 g	1370	M230
1	Hammer mit auswechselbaren Kunststoffaufsätzen \varnothing 35 mm	1390	M230
1	Rollbandmaß 3 m	1692	M230
1	Teleskopmagnetheber mit flexiblen Kopf	1712TF	M230
1	Vierkantfeilen halbschlicht 200 mm	1719BMA..Q	M230
1	Dreieckfeilen, halbschlicht 200 mm	1719BMA..T	M230
1	Flachfeilen halbschlicht 200 mm	1719BMA..P	M230
1	Halbrundfeilen halbschlicht 200 mm	1719BMA..M	M230
1	Rundfeilen halbschlicht 200 mm	1719BMA..R	M230
1	Stahldrahtbürste	1737NX	M230
1	Cutter 18 mm	1771	M230
1	Zangen mit geraden Backen für Sicherungsringe mit Innenspannung \odot 180 mm	1032	M129
1	Zangen mit um 90° gebogenen Backen für Sicherungsringe mit Innenspannung \odot 170 mm	1034	M129
1	Zangen mit geraden Backen für Sicherungsringe mit Außenspannung \bullet 175 mm	1036	M129
1	Zangen mit um 90° gebogenen Backen für Sicherungsringe mit Außenspannung \bullet 175 mm	1038	M129
1	Verstellbare Zangen 250 mm	1048N	M129
1	Gripzange, verstellbar 240 mm	1052	M129
1	Diagonalseitenschneider \sphericalangle 160 mm	1082BM	M129
1	Flechtermesser 220 mm	1098	M129
1	Figureschere, amerikanisches Modell 250 mm	1112	M129
1	Elektrikerschere, gerade Schneiden	1128BM	M129
1	Zange mit halbrunden Backen, extralang, gerade \equiv 180 mm	1150BM	M129
1	Zangen mit halbrunden Backen, gerade \bullet 160 mm	1166BM	M129
1	Zangen mit halbrunden Backen, gebogen \bullet 160 mm	1168BM	M129
1	Einsatzhalter für Schraubeinsätze	895/1	M100
1	Einsatzhalter für Schraubeinsätze	895/3	M100
1	Einsatzhalter für Schraubeinsätze	895/6	M100
13	Sechskant-Steckschlüssel, 1/4" \odot 4-4,5-5-5,5-6-7-8-9-10-11-12-13-14 mm	900	M100
5	Sechskant-Steckschlüssel, lange Ausführung \odot 5-6-7-8-9-10-11-12-13 mm	900L	M100
5	Sechskant-Steckschlüssel 1/4" \odot 3-4-5-6-7 mm	900ME	M100
4	Schraubendrehereinsätze für Schlitzschrauben \bullet 0,8x4-1x5,5-1,2x6,5-1,2x8 mm	900LP	M100
4	Schraubendrehereinsätze für Phillips®-Schrauben \oplus PH1-PH2-PH3-PH4	900PH	M100
7	Steckschlüssel für Torx®-Schrauben \odot T10-T15-T20-T25-T27-T30-T40	900TX	M100
1	Verlängerung, - 1/4" 50 mm	900/20	M100
1	Verlängerung, - 1/4" 100 mm	900/20L	M100
1	Verlängerung, - 1/4" 150 mm	900/21	M100
1	Kardangeln, 1/4"	900/25	M100
1	Steckgriff, 1/4"	900BG/30	M100
1	Gleitgriff, 1/4"	900/42	M100
1	Umschaltknarre, 1/4" \oplus	900/55	M100
21	Sechskant-Steckschlüssel, 1/2" \odot 8-10-11-12-13-14-15-16-17-18-19-20-21-22-23-24-26-27-28-30-32 mm	920A	M100
1	Reduzierstück, Innenvierkant 1/2", Außenvierkant 3/8" 125 mm	920/15	M100
1	Kardangeln, 1/2" 250 mm	920/25	M100
1	Verlängerung, schwenkbar - 1/2"	920AN/125	M100
1	Verlängerung, schwenkbar - 1/2"	920AN/250	M100
1	Gleitgriff, 1/2"	920/42	M100
1	Umschaltknarre, 1/2" \oplus	920/55	M100
8	Steckschlüssel mit Innenvierkantantrieb 1/2", für Torx®-Schrauben \odot 10-12-14-16-18-20-22-24 mm	920FTX	M100
11	Sechskant-Steckschlüssel, lange Ausführung \odot 10-12-13-14-15-16-17-18-19-21-22 mm	920AL	M100



M01



M30



M213

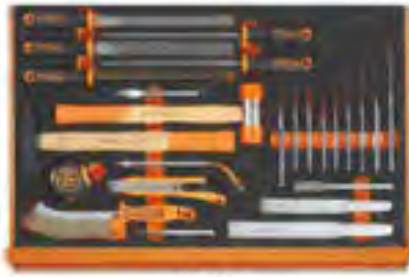

M230



M129

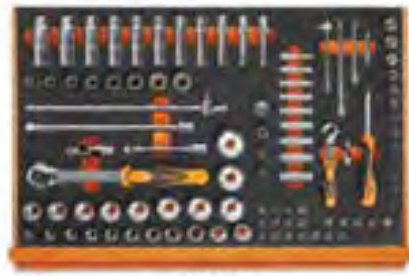

M100

€

5988U6/M 3.560,00 059881430

Sortiment empfohlen in Kombination mit RSC24 mit 8 Schubladen - RSC24/A mit 8 Schubladen - C37 mit 8 Schubladen - C39 mit 8 Schubladen RSC24A-XL - RSC28 - C39SM - C39MO - C59B - RSC50 - RSC55

5935ET/1MB

Werkzeugsortiment, 96-teilig, für Werkzeugkasten C35, im Schaumstoffeinsatz aus EVA

► Elektrotechnik

Stück / Beschreibung

- 1 Gripzange, verstellbar 240 mm
- 1 Schlosserhammer, deutsches Modell 500 g
- 1 Hammer mit auswechselbaren Kunststoffaufsätzen Ø 35 mm
- 1 Vierkantfeilen halbschlicht 200 mm
- 1 Flachfeilen halbschlicht 200 mm
- 1 Dreieckfeilen, halbschlicht 200 mm
- 1 Halbrundfeilen halbschlicht 200 mm
- 1 Rundfeilen halbschlicht 200 mm
- 1 Flachmeißel, mit Hohlprofil 200 mm
- 1 Zangen mit geraden Backen für Sicherungsringe mit Innenspannung Ⓞ 180 mm
- 1 Zangen mit um 90° gebogenen Backen für Sicherungsringe mit Innenspannung Ⓞ 170 mm
- 1 Zangen mit geraden Backen für Sicherungsringe mit Außenspannung ● 175 mm
- 1 Zangen mit um 90° gebogenen Backen für Sicherungsringe mit Außenspannung ● 175 mm
- 1 Diagonalseitenschneider für geringen Kraftaufwand ⚡ 160 mm
- 1 Zange mit halbrunden Backen, extralang, gerade = 180 mm
- 1 Zangen mit halbrunden Backen, gerade ● 160 mm
- 9 Sechskant - Stiftschlüssel, gebogen, mit kugelförmigem Kopf ○
- 1 Festhalteschraubendreher für Schlitzschrauben ●
- 1 Festhalteschraubendreher für Phillips® - Schrauben ⊕
- 1 Schraubendreher mit Spannungsprüfer ●
- 6 Sechskant - Steckschlüssel mit Griff ○ 5,5-6-7-8-10-13 mm
- 4 Schraubendreher für Phillips® - Schrauben, 1000V
- PH0x60-PH1x80-PH2x100-PH3x150 mm
- 6 Schraubendreher für Gewindestifte mit Schlitz, 1000 V ● 2,5x75-3x100-4x100-5,5x125-6x150-8x175 mm
- 31 Sortiment mit 30 Schraubeinsätzen und magnetischer, schnellauslösender Schraubeinsatzhalter, im Kunststoffkasten ● ○ ⊕ ⊕ ⊕ ⊕
- 1 VDE-Einsatzhalter, magnetisch, mit Bimaterial-Griff Ⓢ
- 8 Doppelmaulschlüssel 6x7-8x9-10x11-12x13-14x15 16x17-18x19-20x22 mm
- 1 Verstellbare Zangen mit Tasteneinstellung 250 mm
- 1 Diagonalseitenschneider 1000V ⚡ 140 mm
- 1 Elektrikerschere, gerade Schneiden, mit Kegelsenker
- 1 Kabelschneider mit isolierten Griffen 230 mm
- 1 Abisolierzangen ⚡ 160 mm
- 1 Universalzange 1000V = 180 mm
- 1 Zangen mit halbrunden Backen, extralang 1000V ● 160 mm
- 1 Zangen mit halbrunden Backen, extralang, gebogen ● 160 mm
- 1 Einmaulschlüssel, verstellbar, 1000V 250 mm
- 1 Cutter 1000V
- 1 Gebogene Pinzette mit abgerundeten Spitzen 1000V
- 1 Anpresszange für isolierte Kabelverbindungen

Beta Nr.	TR
1052	MB65
1370	MB65
1390	MB65
1719BMA...Q	MB65
1719BMA...P	MB65
1719BMA...T	MB65
1719BMA...M	MB65
1719BMA...R	MB65
35	MB65
1032	MB65
1034	MB65
1036	MB65
1038	MB65
1084BM	MB65
1150BM	MB65
1166BM	MB65
96BPC/SC9	MB63
1250	MB63
1251	MB63
1253	MB63
943MQ	MB63
1272MQ	MB63
1274MQ	MB63
860MIX/A31	MB63
850MQ	MB63
55	MB64
1048MQ	MB64
1082MQ	MB64
1128BSX	MB64
1132MQ	MB64
1142MQ	MB64
1150MQ	MB64
1166MQ	MB64
1168MQ	MB64
110MQ	MB64
1777MQ	MB64
993MQ	MB64
1602	MB64



MB65



MB64

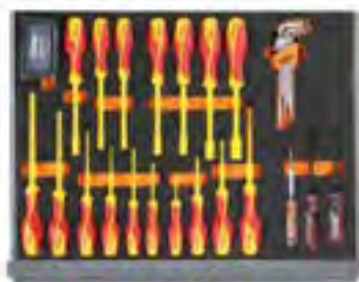

MB63

5935ET/1MB € 2.160,00 059351332

Sortiment empfohlen in Kombination mit C35



5980ET/A

Werkzeugsortiment, 70-teilig

► Elektrotechnik

Stück / Beschreibung	Beta Nr.
1 Körner Ø 4 mm	32
1 Flachmeißel, mit Hohlprofil 150 mm	35
8 6x7 - 8x9 - 10x11 - 12x13 - 14x15 - 16x17 - 18x19 - 20x22 mm	55/B8N
8 Sechskant-Stiftschlüssel, lange Ausführung ⌀ 2+10 mm	96LC/SC8
1 Einmaulschlüssel, verstellbar 200 mm	111E
1 VDE-Einsatzhalter, magnetisch, mit Bimaterial-Griff	850MQ
10 Schraubeinsätze und magnetischer Schraubeinsatzhalter	860MIX/A10
1 Verstellbare Zangen mit Tasteneinstellung 250 mm	1048MQ
1 Diagonalseitenschneider 160 mm	1082BM
1 Elektrikerschere, gerade Schneiden, mit Kegelsenker	1128BSX
1 Kabelschneider 170 mm	1132BM
1 Zange mit halbrunden Backen, extralang, gerade 180 mm	1150BM
1 Zangen mit halbrunden Backen, gerade 160 mm	1166BM
1 Zangen mit halbrunden Backen, gebogen 160 mm	1168BM
1 Festhalteschraubendreher für Schlitzschrauben 4x125 mm	1250
1 Festhalteschraubendreher für Phillips® - Schrauben PH1x125 mm	1251
1 Schraubendreher mit Spannungsprüfer	1253
5 Schraubendreher für Schlitzschrauben 2,5x75 - 3,5x100 - 5,5x125 - 6,5x150 mm	1201E
1 Schraubendreher für Schlitzschrauben, extrakurze Klinge 4x30 mm	1201EN
4 Schraubendreher für Phillips®-Schrauben PH0x60 - PH1x120 - PH2x150 - PH3x150 mm	1202E
1 Schraubendreher für Phillips®-Schrauben, extrakurze Klinge PH2x30 mm	1202EN
4 Schraubendreher für Phillips® - Schrauben, 1000V PH0x60 - PH1x80 - PH2x100 - PH3x150 mm	1272MQ
5 Schraubendreher für Gewindestifte mit Schlitz, 1000 V 5,5x125 - 3x100 - 4x100 - 6,5x150 - 8x175 mm	1274MQ
1 Trennmeißel	1343
1 Schlosserhammer, deutsches Modell 300 g	1370
1 Hammer mit austauschbaren Kunststoffaufsätzen Ø 35 mm	1390
1 Anpresszange für isolierte Kabelverbindungen	1602
1 25 mm	BMESB1925NE
1 Rollbandmaß 5 m	1692
1 Halbrundfeilen halbschlicht 200 mm	1719BMA...M
1 Rundfeilen halbschlicht 200 mm	1719BMA...R
1 Sägebogen	1725
1 Klappmesser	1777BM

€

5980ET/A 1.093,00 059801083

Sortiment empfohlen in Kombination mit C12 - 2028VV - 2032TV - 2032VV



5980ET/B

Werkzeugsortiment, 64teilig

► Elektrotechnik

Stück / Beschreibung	Beta Nr.
3 Splinttreiber Ø 2 - 3 - 4 mm	31
1 Körner Ø 4 mm	32
1 Flachmeißel 150 mm	34
8 6x7 - 8x9 - 10x11 - 12x13 - 14x15 - 16x17 - 18x19 - 20x22 mm	55/B8N
9 Sechskant - Stiftschlüssel, gebogen, mit kugelförmigem Kopf ○ 1,5 - 2 - 2,5 - 3 - 4 - 5 - 6 - 8 - 10 mm	96BPC/SC9
1 Entgrater 150 mm	345SB
6 Sechskant - Steckschlüssel mit Griff 1000V ○ 5,5 - 6 - 7 - 8 - 10 - 13 mm	943MQ/S6
1 Verstellbare Zangen mit Tasteneinstellung 250 mm	1048MQ
1 Diagonalseitenschneider 1000V ⚡ 160 mm	1082MQ
1 Elektrikerschere, gerade Schneiden, mit Kegelsenker	1128BSX
1 Kabelschneider mit isolierten Griffen 230 mm	1132MQ
1 Abisolierzangen ⚡ 160 mm	1142MQ
1 Universalzange 1000V = 180 mm	1150MQ
1 Zangen mit halbrunden Backen, extralang 1000V ● 160 mm	1166MQ
1 Schraubendreher mit Spannungsprüfer ●	1253
3 Schraubendreher für Phillips® - Schrauben, 1000V ⊕ PH0x60 - PH1x80 - PH2x100 mm	1272MQ
4 Schraubendreher für Gewindestifte mit Schlitz, 1000 V ● 3x100 - 4x100 - 5,5x125 - 6,5x150 mm	1274MQ
1 Schlosserhammer, deutsches Modell 300 g	1370
1 Hammer mit auswechselbaren Kunststoffaufsätzen Ø 35 mm	1390
1 Anpresszange für isolierte Kabelverbindungen	1602
1 flexibler Maßstab 250 mm	1682
1 Reißnadel 250 mm	1688
1 Rollbandmaß 5 m	1692
1 Wasserwaage aus Aluminium 200 mm	1696
1 Elektrikermeißel 10x200 mm	1701NE3
1 Markierschnur	1705
1 Inspektionsspiegel, flexibel 600 mm	1715FL/A
1 Feilen für normale Bearbeitung 200 mm	1719BMA8/M
1 Feilen für normale Bearbeitung 200 mm	1719BMA8/R
1 Federspanner	1723
1 Sägebogen	1726BM
1 Pinsel	1738
1 Anpresszange für Nylonkabelbinder	1743
1 Kunststoffölkanne mit Pumpe 150 cc	1754
100 Nylonkabelbinder, schwarz, UV-strahlenbeständig 3,6x200 mm	1748N
100 Nylonkabelbinder, schwarz, UV-strahlenbeständig 4,8x300 mm	1748N
1 Cutter	1771BM
1 LötKolben mit Zusatzheizleistung 30 W	1814M
1 LED-Inspektionslampe, aus robustem eloxiertem Aluminium	1833XS/2

€ 1.500,00 059801084

Sortiment empfohlen in Kombination mit C12 - 2029/WV - 2033P/VV - 2036TV



5980MQ

Werkzeugsortiment, 46-teilig

► Elektrotechnik

Stück / Beschreibung	Beta Nr.
7 Einmaulschlüssel 1000V 10 - 12 - 13 - 14 - 17 - 19 - 22 mm	52MQ
1 Einmaulschlüssel, verstellbar, 1000V 250 mm	110MQ
6 Sechskant - Steckschlüssel mit Griff ○ 5,5 - 6 - 7 - 8 - 10 - 13 mm	943MQ
4 Stiftschlüssel mit T-Griff, Sechskantprofil an drei Enden ○ 4 - 5 - 6 - 8 mm	951MQ
1 Gebogene Pinzette mit abgerundeten Spitzen 1000V	993MQ
1 Verstellbare Zangen mit Tasteneinstellung 250 mm	1048MQ
1 Diagonalseitenschneider 1000V ⚡ 160 mm	1082MQ
1 Elektrikerschere	1128MQ
1 Abisolierzangen ⚡ 160 mm	1142MQ
1 Universalzange 1000V = 180 mm	1150MQ
1 Flachzangen mit gebogenen Backen = 160 mm	1164MQ
1 Zangen mit halbrunden Backen, extralang 1000V ● 160 mm	1166MQ
1 Schraubendreher mit Spannungsprüfer ●	1253
4 Schraubendreher für Phillips® - Schrauben, 1000V ⊕ PH0x60 - PH1x80 - PH2x100 - PH3x150 mm	1272MQ
5 Schraubendreher für Gewindestifte mit Schlitz, 1000 V ● 3x100 - 4x100 - 5,5x125 - 6,5x150 - 8x175 mm	1274MQ
1 Schlosserhammer, deutsches Modell 300 g	1370
1 Hammer mit auswechselbaren Kunststoffaufsätzen Ø 35 mm	1390
1 Rollbandmaß 5 m	1692
1 200 mm	1701NE/3
1 Kleinstsägebogen 1000V	1725MQ
2 Cutter 1000V	1777MQ
1 LötKolben mit Zusatzheizleistung 30 W	1814M
1 LED-Taschenlampe, leuchtstark, aus robustem eloxiertem Aluminium, bis zu 500 Lumen	1833S
1 Spannungs- und Durchgangsprüfgerät 12-690V AC/DC	1760PT

€ 2.030,00 059801257

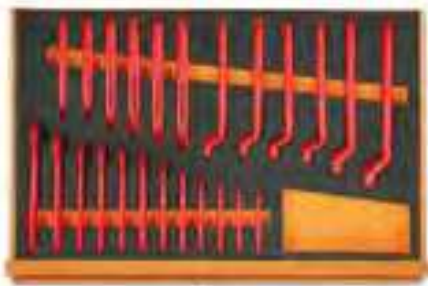

M49



M108



M161

5988 VHB-MQ

Werkzeugsortiment, 66-teilig, im Schaumstoffeinsatz aus EVA

► Elektrotechnik

Stück / Beschreibung

- 12 Einmaulschlüssel 1000V 7-8-10-11-12-13-14-15-16-17-19-22 mm
- 12 Einringschlüssel 7-8-10-11-12-13-14-15-16-17-19-22 mm
- 4 Sechskant-Steckschlüssel \odot 4-5-6-8 mm
- 11 Zwölfkant-Steckschlüssel \odot 7-8-10-11-12-13-14-15-16-17-19 mm
- 6 Steckschlüssel für Torx®-Schrauben \odot T15-T20-T25-T27-T30-T40
- 2 Steckschlüssel für XZN®-Schrauben \odot 8-10 mm
- 1 Verlängerung Innen- und Außenvierkant 3/8" 125 mm
- 1 Verlängerung Innen- und Außenvierkant 3/8" 250 mm
- 1 Verlängerung mit Kardangelenk, Außenvierkant 3/8"
- 1 Umschaltknarre, Außenvierkant 3/8"
- 1 Elektrikerschere
- 1 Verstellbare Zangen mit Tasteneinstellung 250 mm
- 1 Diagonalseitenschneider 1000V ∇ 160 mm
- 1 Universalzange 1000V \equiv 180 mm
- 1 Flachzangen mit geraden Backen, extralang \equiv 160 mm
- 1 Flachzangen mit gebogenen Backen \equiv 160 mm
- 4 Schraubendreher für Phillips® - Schrauben, 1000V \oplus PH0x60 - PH1x80 - PH2x100 - PH3x150 mm
- 4 Schraubendreher für Gewindestifte mit Schlitz, 1000 V \bullet 2,5x75 - 3x100 - 4x100 - 5,5x125 mm
- 1 Abisoliermesser

Beta Nr.	TR
52MQ	M49
89MQ	M49
910MQ/PE	M108
910MQ/B	M108
910MQ/TX	M108
910MQ/XZN	M108
910MQ/21	M108
910MQ/22	M108
910MQ/T	M108
910MQ/55	M108
1128MQ	M161
1048MQ	M161
1082MQ	M161
1150MQ	M161
1162MQ	M161
1164MQ	M161
1272MQ	M161
1274MQ	M161
1777MQ/U	M161

€

5988 VHB-MQ 3.350,00 059880300

Sortiment empfohlen in Kombination mit RSC51 - RSC23T - RSC24 - RSC24A - RSC24A-XL - RSC24L - RSC24L/CAB RSC28 - C37 - C39 - C39SM - C39MD - C39T - RSC55 - RSC50 - C59



5980EL/A

Werkzeugsortiment, 57teilig

► Elektronik

Stück / Beschreibung

- 13 4+14 mm
- 9 Sechskant-Stiftschlüssel, gebogen \odot 1,5+10 mm
- 1 gebogene Pinzette mit feinen Spitzen 130 mm
- 1 gerade Pinzette mit feinen Spitzen 150 mm
- 1 gerade Pinzette mit gekreuzten Backen 155 mm
- 1 Elektrikerschere, gerade Schneiden
- 1 Abisolierzange ∇ 160 mm
- 1 Zangen mit halbrunden Backen, gerade \bullet 160 mm
- 1 Flachzange mit langen Backen \equiv
- 1 Zange mit halbrunden Backen, lang, glatt, gebogen \bullet
- 1 Universalzange \bullet
- 1 Diagonalseitenschneider für bündigen Schnitt ∇
- 1 Diagonalseitenschneider für normalen Schnitt ∇
- 1 Festhalteschraubendreher für Schlitzschrauben \bullet 4x125 mm
- 1 Festhalteschraubendreher für Phillips® - Schrauben \oplus PH0x125 mm
- 8 Elektronikschraubendreher
- 1 Schlosserhammer, deutsches Modell 200 g
- 1 Rollbandmaß 5 m
- 1 Inspektionsspiegel, teleskopisch
- 3 Nadelfeilen
- 1 Federspanner
- 1 Pinsel
- 1 Tropfenöler in Kugelschreiberform
- 1 Cutter
- 1 Selbstblockierende Festhaltezange mit abgerundeten Backen, gezahnt, aus Edelstahl
- 1 LötKolben mit Zusatzheizleistung 25 W
- 1 Lötinnabsaugpumpe
- 1 LED-Inspektionslampe, aus robustem eloxiertem Aluminium

Beta Nr.
73/B13N
96N/SC9
991
992
998
1128BMX
1142BM
1166BM
1172BM
1178BM/P
1178BM
1185BM
1188BM
1250
1251
1257LPH/S8
1370
1692
1715
1720/S3
1723
1738
1756
1771
1002
1814M
1830T
1833XS/2

€

5980EL/A 1.083,00 059801081

Sortiment empfohlen in Kombination mit 2032TV - 2028/VV - 2033P/VV

5980EL/B

Werkzeugsortiment, 98teilig



► Elektronik

Stück / Beschreibung	Beta Nr.
13 4+14 mm	73/B13N
9 Sechskant-Stiftschlüssel, gebogen \odot 1,5+10 mm	96/SC9
8 Stiftschlüssel, gebogen, für Torx® - Schrauben \odot T9 - T10 - T15 - T20 - T25 - T27 - T30 - T40	97TX/BG8
1 Einmaulschlüssel, verstellbar 150 mm	111E
13 Sechskant - Steckschlüssel und 5 Betätigungswerkzeuge, 1/4"	900/C13-5
1 gerade Pinzette mit feinen, abgerundeten Spitzen 130 mm	990
1 gebogene Pinzette mit feinen Spitzen 130 mm	991
1 Pinzette mit sehr spitzen Backen 120 mm	999A
1 Elektrikerschere, gerade Schneiden	1128BMX
1 selbstverstellbare Schneid - und Abisolierzange 170 mm	1149F
1 Zange mit halbrunden Backen, extralang, gerade \equiv 180 mm	1150BM
1 Flachzange mit langen Backen \equiv 140 mm	1172BM
1 Klappmesser \bullet 140 mm	1177BM
1 Zange mit halbrunden Backen, lang, glatt, gebogen \bullet 140 mm	1178BM/P
1 Diagonalseitenschneider für bündigen Schnitt, abgerundete Backen ζ 120 mm	1184BM
1 Diagonalseitenschneider für bündigen Schnitt, schlanke, abgeflachte Backen ζ 120 mm	1186BM
1 Vornschneder, abgeschrägt, für bündigen Schnitt ζ	1191BM
8 Elektronikschraubendreher	1257LPH/S8
1 Schraubendreher mit Spannungsprüfer \bullet	1253
1 Schraubendreher für Schlitzschrauben, extrakurze Klinge \bullet 6,5x30 mm	1290N
3 Schraubendreher für Phillips®-Schrauben \oplus PH0x60 - PH1x80 - PH2x100 mm	1292
2 Schraubendreher für Phillips®-Schrauben, extrakurze Klinge \oplus PH1x30 - PH2x30 mm	1292N
5 Schraubendreher für Gewindestifte mit Schlitz \bullet 2,5x60 - 3x75 - 4x100 - 5x125 - 6,5x150 mm	1294
1 Schlosserhammer, deutsches Modell 200 g	1370
1 flexibler Maßstab 150 mm	1682
1 Reißnadel 220 mm	1688
1 Rollbandmaß 5 m	1692
1 Inspektionsspiegel, teleskopisch 670 mm	1715
1 Nadelfeilen \bullet	1720R
1 Nadelfeilen \blacktriangle	1720T
1 Nadelfeilen \blacksquare	1720P
1 Federspanner	1723
1 Pinsel	1738
1 Tropfenöler in Kugelschreiberform	1756
1 Cutter	1771BM
1 Klappmesser	1777BM
1 Selbstblockierende Festhaltezange mit abgerundeten Backen, gezahnt, aus Edelstahl	1002
1 LötKolben mit Zusatzheizleistung 25W	1814M
1 Lötzinnabsaugpumpe	1830T
1 LED-Inspektionslampe, aus robustem eloxiertem Aluminium	1833XS/2

€

5980EL/B 1.520,00 059801082

Sortiment empfohlen in Kombination mit 2029/IVV - 2033P/IVV - 2036TV



5980ID/1

Werkzeugsortiment, 24-teilig

► Hydraulik

Stück / Beschreibung

Beta Nr.

1	Einmaulschlüssel, verstellbar 250 mm	111E
1	Ø 3+28 mm	332/2
1	Rohrschneider für Kupfer und Leichtmetalle Ø 3+30 mm	334
1	Ø 0+42 mm	342
1	140 mm	345SB2
2	320-410 mm	376
2	Verstellbare Zangen 175-250 mm	1048N
1	Elektrikerschere, gerade Schneiden	1128BMX
1	Universalzangen für geringen Kraftaufwand, Griffe aus Bimaterial, Industrie-Finish \equiv 180 mm	1150GBM
4	Schraubendreher für Schlitzschrauben ● 3x75-4x100-5,5x150-8x150 mm	1201E
2	Schraubendreher für Phillips®-Schrauben ⚙ PH1x80-PH2x100	1202E
1	Schlosserhammer, deutsches Modell 500 g	1370
1	Rollbandmaß aus Fasern 2 m	1690F
1	Rollbandmaß 5 m	1692/5
1	Wasserwaage aus Aluminium 200 mm	1696
1	Halbrundfeilen halbschlicht 200 mm	1719BMA...M
1	Holzraspel, flachstumpf 200 mm	1719BM/RL
1	Sägebogen	1725

€

5980ID/1

631,00 059801086

Beta

5989 VEM

Werkzeugsortiment, 81-teilig, für die Reparatur und Wartung von Hybrid- und Elektrofahrzeugen

► KFZ-Mechanik

Stück / Beschreibung

- 1 Isoliermatte
- 4 Kunststoffsäulen mit auffüllbarem Sockel
- 1 Multimeter/Megaohmmeter für Hochspannungs-Isolationstest.Effektivwertmessung TRUE RMS
- 1 Spannungs- und Durchgangsprüfgerät 12-690V AC/DC
- 1 Ersatzprüfspitzen für Mehrzweck-Digitalmultimeter und Stromzangen
- 1 Isolierhandschuhe aus Verbundmaterial Gr. 10
- 1
- 1 Abgrenzungskette aus Kunststoff
- 2 Warnschilder aus Aluminium A1, A2
- 2 Verbotsschilder D2, D3
- 12 Einmaulschlüssel 1000V 7-8-10-11-12-13-14-15-16-17-19-22 mm
- 12 Einringschlüssel 7-8-10-11-12-13-14-15-16-17-19-22 mm
- 4 Sechskant-Steckschlüssel \odot 4-5-6-8 mm
- 11 Zwölfkant-Steckschlüssel \odot 7-8-10-11-12-13-14-15-16-17-19 mm
- 6 Steckschlüssel für Torx®-Schrauben \odot TX15-TX20-TX25-TX27-TX30-TX40
- 2 Steckschlüssel für XZN®-Schrauben \odot M8-M10
- 1 Verlängerung Innen- und Außenvierkant 3/8" 140 mm
- 1 Verlängerung Innen- und Außenvierkant 3/8" 265 mm
- 1 Verlängerung mit Kardangelenk, Außenvierkant 3/8" 200 mm
- 1 Umschaltknarre, Außenvierkant 3/8" 203 mm
- 1 Verstellbare Zangen mit Tasteneinstellung 250 mm
- 1 Diagonalseitenschneider 1000V \nless 160 mm
- 1 Elektrikerschere 145 mm
- 1 Universalzange 1000V \equiv 180 mm
- 1 Flachzangen mit geraden Backen, extralang \equiv 160 mm
- 1 Flachzangen mit gebogenen Backen \equiv 160 mm
- 4 Schraubendreher für Phillips® - Schrauben, 1000V \oplus PH0-PH1-PH2-PH3
- 4 Schraubendreher für Gewindestifte mit Schlitz, 1000 V \bullet 2,5x75-3x100-4x100-5.5x125 mm
- 1 Abisoliermesser 190 mm

Beta Nr.	TR
1995MQ/T	
7104 90	
1760/OHM	
1760PT	
1760DGT-R3	
1996MQ/GM	
1996VPG	
7105 6	
7109A	
7109D	
52MQ	M49
89MQ	M49
910MQ/PE	M108
910MQ/B	M108
910MQ/TX	M108
910MQ/XZN	M108
910MQ/21	M108
910MQ/22	M108
910MQ/T	M108
910MQ/55	M108
1048MQ	M161
1082MQ	M161
1128MQ	M161
1150MQ	M161
1162MQ	M161
1164MQ	M161
1272MQ	M161
1274MQ	M161
1777MQ/U	M161

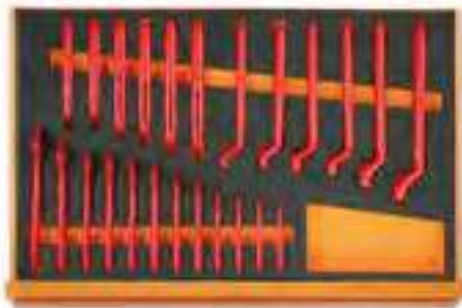

M49



M108



M161



5989 VEM

€ 5.770,00 059890116

Sortiment empfohlen in Kombination mit RSC24/6-R

5902MT

Werkzeugsortiment, 106teilig, für Landwirtschafts-, Bau- und Erdbewegungsmaschinen



► Erdbewegung

Stück / Beschreibung

Stück / Beschreibung	Beta Nr.
2 Durchschläger Ø 3 - 4 mm	30
2 Splinttreiber Ø 6 - 8 mm	31
1 Körner Ø 4 mm	32
2 Flachmeißel, mit Hohlprofil 150 - 200 mm	35
18 Ring-Maulschlüssel 6÷14 - 17 - 19 - 22 - 24 - 27 - 30 - 32 - 36 - 41 mm	42
10 Doppelringschlüssel, tief gekröpft 6x7 - 8x9 - 10x11 - 12x13 - 14x15 - 16x17 - 18x19 - 20x22 - 24x27 - 30x32 mm	90
10 Sechskant-Stiftschlüssel, gebogen ○ 1,5÷12 mm	96N/B10
17 Sechskant-Steckschlüssel, 1/2" ○ 10÷22 - 24 - 27 - 30 - 32 mm	920A
1 Verlängerung, 1/2" 125 mm	920/21
1 Verlängerung, 1/2" 255 mm	920/22
1 Kardangelenk, 1/2"	920/25
1 Gleitgriff, 1/2"	920/42
1 Einfachknarre, 1/2" ⊗	920/50
11 Sechskant - Steckschlüssel, 3/4" ○ 22 - 24 - 27 - 30 - 32 - 36 - 41 - 46 - 50 - 55 - 60 mm	928A
1 Verlängerung, 3/4" 200 mm	928/21
1 Gelenkgriff, Außenvierkant 3/4"	928/36A
1 Gleitgriff, 3/4"	928/42
1 Umschaltknarre, 3/4" ⊗	928/55
1 Hebeleisen, gebogen	964
1 Verstellbare Zangen 250 mm	1048N
1 Gripszange, verstellbar, speziell geformte Backen	1055
1 Diagonalseitenschneider für geringen Kraftaufwand, Griffe aus Bimaterial, Industrie-Finish ≡ 160 mm	1084GBM
1 Elektrikerschere, gerade Schneiden	1128BMX
1 Universalzangen für geringen Kraftaufwand, Griffe aus Bimaterial, Industrie-Finish ≡ 180 mm	1150GBM
1 Zangen mit halbrunden Backen, extralang, gerade, innengeriffelt, Griffe aus Bimaterial, Industrie-Finish ≡ 160 mm	1166GBM
4 Schraubendreher für Schlitzschrauben, Klinge mit Sechskant ● 6,5x150 - 8x175 - 10x200 - 12x250 mm	1260E
3 Schraubendreher für Phillips® - Schrauben, Klinge mit Sechskant, ⊕ PH2x150 - PH3x175 - PH4x200 mm	1262E
1 Schlosserhammer, amerikanisches Modell 900 g	1377
1 Hammer mit austauschbaren Kunststoffaufsätzen Ø 35 mm	1390
1 Fühlerlehre	1708/20
1 Dreikantschaber 200 mm	1717B
5 Feilensatz, 5-teilig, halbschlicht, mit Griff 200 mm	1719BMA...S5
1 Sägebogen	1725

€

5902MT 2.495,00 059021053

Sortiment empfohlen in Kombination mit RSC22 - RSC23 - RSC23C - C39T

5902MT/AS

Werkzeugsortiment, 99teilig, für Erdbewegungsmaschinen (CATERPILLAR)



► Erdbewegung

Stück / Beschreibung	Beta Nr.
2 Durchschläger Ø 3 - 4 mm	30
2 Splinttreiber Ø 6 - 8 mm	31
1 Körner Ø 4 mm	32
2 Flachmeißel, mit Hohlprofil 150 - 200 mm	35
20 Ring-Maulschlüssel 1/4÷1.1/2"	42AS
6 Doppelringschlüssel, tief gekröpft 1/4x5/16 - 3/8x7/16 - 1/2x9/16 5/8x3/4 - 11/16x13/16 - 7/8x15/16"	90AS
11 Sechskant-Stiftschlüssel, gebogen ○ 3/64÷3/8"	96AS/B11
10 Zwölfkant - Steckschlüssel, 1/2" ○ 7/16 - 1/2 - 9/16 5/8 - 11/16 - 3/4 - 13/16 - 7/8 - 15/16 - 1"	920AS
1 Verlängerung, 1/2" 125 mm	920/21
1 Verlängerung, 1/2" 255 mm	920/22
1 Kardangelenk, 1/2"	920/25
1 Gleitgriff, 1/2"	920/42
1 Einfachknarre, 1/2" ⊗	920/50
12 Sechskant - Steckschlüssel 1/4" ○ □ 3/4", 7/8 - 15/16 - 1 - 1.1/16 - 1.1/8 - 1.1/4 - 1.5/16 1.1/2 - 1.5/8 - 1.11/16 - 1.7/8 - 2"	928AS
1 Verlängerung, 3/4" 200 mm	928/21
1 Gelenkgriff, Außenvierkant 3/4"	928/36A
1 Gleitgriff, 3/4"	928/42
1 Umschaltknarre, 3/4" ⊗	928/55
1 Hebeleisen, gebogen	964
1 Verstellbare Zangen 250 mm	1048N
1 Gripzange, verstellbar, speziell geformte Backen	1055
1 Diagonalseitenschneider für geringen Kraftaufwand, Griffe aus Bimaterial, Industrie-Finish 160 mm	1084GBM
1 Elektrikerschere, gerade Schneiden	1128BMX
1 Universalzangen für geringen Kraftaufwand, Griffe aus Bimaterial, Industrie-Finish 180 mm	1150GBM
1 Zangen mit halbrunden Backen, extralang, gerade, innengeriffelt, Griffe aus Bimaterial, Industrie-Finish 160 mm	1166GBM
4 Schraubendreher für Schlitzschrauben, Klinge mit Sechskant ●	1260E
3 Schraubendreher für Phillips® - Schrauben, Klinge mit Sechskant, ⊕	1262E
PH2x150 - PH3x175 - PH4x200 mm	
1 Schlosserhammer, amerikanisches Modell 900 g	1377
1 Hammer mit auswechselbaren Kunststoffaufsätzen Ø 35 mm	1390
1 Fühlerlehre 150 - 200 mm	1708/20
1 Dreikantschaber 200 mm	1717B
5 Feilensatz, 5-teilig, halbschlicht, mit Griff 200 mm	1719BMA...S5
1 Sägebogen	1725

€ 

5902MT/AS 2.620,00 059021054

Sortiment empfohlen in Kombination mit RSC22 - RSC23 - RSC23C - C39T

5904VG/2M

Werkzeugsortiment, 170-teilig, im Schaumstoffeinsatz aus EVA

► KFZ-Mechanik

Stück / Beschreibung

- 16 Ring-Maulschlüssel 6+21 mm
- 5 Ring-Maulschlüssel 22 - 24 - 27 - 30 - 32 mm
- 8 Sechskant - Stiftschlüssel mit Griff \odot 2-2,5-3-4-5-6-7-8 mm
- 5 Stiftschlüssel mit Griff, für Torx®-Schrauben \odot T10-T15-T20-T25-T30
- 7 Sechskant-Schraubeinsätze \odot 4-5-6-7-8-10-12 mm
- 7 Sechskant-Schraubeinsätze \odot 4-5-6-7-8-10-12 mm
- 5 Schraubeinsätze für Vielzahnschrauben (XZN®) \odot 5-6-8-10-12 mm
- 5 Schraubeinsätze für Vielzahnschrauben (XZN®) \odot 5-6-8-10-12 mm
- 7 Schraubeinsätze für Torx®-Schrauben \odot T20-T25-T30-T40-T45-T50-T55
- 6 Schraubeinsätze für Torx®-Schrauben \odot T25-T30-T40-T45-T50-T55
- 7 Schraubeinsätze für Sicherheitsschrauben Tamper Resistant Torx® \odot T20-T25-T30-T40-T45-T50-T55
- 1 Einsatzhalter für Schraubeinsätze Art. 867
- 1 Einsatzhalter für Schraubeinsätze Art. 867
- 5 Schraubendreher für Schlitzschrauben \bullet 3x75 - 3,5x100 - 4x125 - 5,5x150 - 6,5x150 mm
- 3 Schraubendreher für Phillips®-Schrauben \oplus PH0x60 - PH1x80 - PH2x100 mm
- 1 Schraubendreher für Schlitzschrauben, extrakurze Klinge \bullet 4x30 mm
- 1 Schraubendreher für Phillips® - Schrauben, extrakurze Klinge \oplus PH1x30 mm
- 5 Farbige Schraubeinsätze für Schlitzschrauben \bullet 0,5x3 - 0,6x4,5 - 0,8x5,5 - 1x5,5 - 1,2x6,5 mm
- 8 Farbige Sechskant-Schraubeinsätze \odot 2 - 2,5 - 3 - 4 - 5 - 6 - 8 - 10 mm
- 5 Farbige Schraubeinsätze für Phillips®-Schrauben \oplus PH0 - PH1 - PH2 - PH3 - PH4
- 4 Farbige Schraubeinsätze für Pozidriv®- und Supadriv®-Schrauben \oplus PZ1 - PZ2 - PZ3 - PZ4
- 11 Farbige Schraubeinsätze für Torx®-Schrauben \odot T6-T7-T8-T9-T10-T15-T20-T25-T27-T30-T40
- 8 Farbige Schraubeinsätze für Sicherheitsschrauben Tamper Resistant Torx® \odot T9-T10-T15-T20-T25-T27-T30-T40
- 1 Einsatzhalter, mit Schnellanschluss und Griff 230 mm
- 1 Umschaltknarre für Einsatzhalter 100 mm
- 1 Magnetverlängerung für Einsatzhalter 80 mm
- 1 Adapter für Steckschlüssel \blacksquare 1/4 - \square 1/4
- 2 Flachmeißel, mit Hohlprofil 100 - 200 mm
- 1 Schlosserhammer, deutsches Modell 300 g
- 1 Hammer mit auswechselbaren Kunststoffaufsätzen \varnothing 35 mm
- 1 Verlängerung, schwenkbar - 1/2" 125 mm
- 1 Verlängerung, schwenkbar - 1/2" 250 mm
- 1 Kardangelenke, 1/2"
- 1 Gleitgriff, 1/2"
- 1 Umschaltknarre, 1/2" \oplus
- 19 Sechskant-Steckschlüssel, 1/2" \odot 10+24 - 26 - 27 - 30 - 32 mm
- 1 Zange mit halbrunden Backen, extralang, gerade \equiv 180 mm
- 1 Zangen mit halbrunden Backen, gerade \bullet 160 mm
- 1 Diagonalseitenschneider für geringen Kraftaufwand \nlessgtr 160 mm
- 1 Zangen mit geraden Backen für Sicherungsringe mit Innenspannung \odot 180 mm
- 1 Zangen mit um 90° gebogenen Backen für Sicherungsringe mit Innenspannung \odot 170 mm
- 1 Zangen mit geraden Backen für Sicherungsringe mit Außenspannung \bullet 175 mm
- 1 Zangen mit um 90° gebogenen Backen für Sicherungsringe mit Außenspannung \bullet 175 mm

Beta Nr.	TR
42	M05
42	M06
96T	M50
97TTX	M55
867PE	M86
867PEL	M86
867XZN	M86
867XZNL	M86
867TX	M86
867TXL	M86
867RTX	M86
867/1	M86
867/2	M86
1260	M208
1262	M208
1260N	M208
1262N	M208
860LP	M85
860PE	M85
860PH	M85
860PZ	M85
860TX	M85
860RTX	M85
851SR	M85
860/55	M85
862P	M85
8920	M85
35	M234
1370	M234
1390	M234
920AN/125	M83
920AN/250	M83
920/25	M83
920/42	M83
920/55	M83
920A	M83
1150BM	M136
1166BM	M136
1084BM	M136
1032	M145
1034	M145
1036	M145
1038	M145



M05 M06 VPM3



M50 M55 M86



M208 M85 M234



M83 M136 M145



5904VG/2M 1.995,00 059041198

Sortiment empfohlen in Kombination mit RSC24 - RSC24A - RSC24A-XL - C37 - C39
RSC24L - RSC24L/CAB - C59 - C39T - C39SM - C39MD - RSC23T - RSC28 - RSC50 - RSC55

5904VG/2T

Werkzeugsortiment, 99-teilig, im festen Thermoformateinsatz aus ABS

► KFZ-Mechanik

Stück / Beschreibung

- 16 Ring-Maulschlüssel 6+21 mm
- 5 Ring-Maulschlüssel 22 - 24 - 27 - 30 - 32 mm
- 19 Sechskant-Steckschlüssel, 1/2" ⌀ 10+24 - 26 - 27 - 30 - 32 mm
- 5 Sechskant-Steckschlüssel mit Innenvierkanttrieb, 1/2" ⌀ 5 - 6 - 8 - 10 - 12 mm
- 1 Verlängerung, 1/2" 125 mm
- 1 Verlängerung, 1/2" 255 mm
- 1 Kardangelenk, 1/2"
- 1 Gleitgriff, 1/2"
- 1 Umschaltknarre, 1/2" ⌀
- 1 Verstellbare Zangen 250 mm
- 1 Gripzange, verstellbar 240 mm
- 1 Diagonalseitenschneider für geringen Kraftaufwand ∇ 160 mm
- 1 Zangen mit halbrunden Backen, gerade ● 160 mm
- 1 Zange mit halbrunden Backen, extralang, gerade = 180 mm
- 1 Zangen mit geraden Backen für Sicherungsringe mit Innenspannung Ⓞ 180 mm
- 1 Zangen mit geraden Backen für Sicherungsringe mit Außenspannung ● 175 mm
- 1 Zangen mit um 90° gebogenen Backen für Sicherungsringe mit Innenspannung Ⓞ 170 mm
- 1 Zangen mit um 90° gebogenen Backen für Sicherungsringe mit Außenspannung ● 175 mm
- 2 Flachmeißel, mit Hohlprofil 100 - 200 mm
- 1 Schlosserhammer, deutsches Modell 300 g
- 1 Hammer mit auswechselbaren Kunststoffaufsätzen Ø 35 mm
- 4 Schraubendreher für Schlitzschrauben ● 3x75 - 4x100 - 5,5x150 - 6,5x150 mm
- 3 Schraubendreher für Phillips®-Schrauben ● PH0x60 - PH1x80 - PH2x100 mm
- 8 Doppelmaulschlüssel 6x7 - 8x9 - 10x11 - 12x13 - 14x15 - 16x17 - 18x19 - 20x22 mm
- 9 Sechskant-Stiftschlüssel, gebogen Ⓞ 1,5 - 2 - 2,5 - 3 - 4 - 5 - 6 - 8 - 10 mm
- 6 Sechskant - Stiftschlüssel mit Griff Ⓞ 2 - 2,5 - 3 - 4 - 5 - 6 mm
- 6 Stiftschlüssel mit Griff, für Torx®-Schrauben Ⓞ T10 - T15 - T20 - T25 - T27 - T30

Beta Nr.	TR
42	T05
42	T06
920A	T80
920ME	T80
920/21	T80
920/22	T80
920/25	T80
920/42	T80
920/55	T80
1048N	T153
1052	T153
1084	T138
1166	T138
1150	T138
1032	T145
1036	T145
1034	T145
1038	T145
35	T234
1370	T234
1390	T234
1260	T208
1262	T208
55	T33
96/SC9	T33
96T	T52
97TTX	T55



5904VG/2T

€ 1.690,00 059041191

Sortiment empfohlen in Kombination mit RSC51 - RSC24 - RSC24A - RSC24A-XL - C37 - C39
RSC23T - C39T - RSC24L - RSC24L/CAB - C59 - RSC28 - C39SM - C39MD - RSC50 - RSC55



5904VG/3

Werkzeugsortiment, 132teilig

► KFZ-Mechanik

Stück / Beschreibung	Beta Nr.
6 Ø 2÷8 mm	31/B6N
1 Körner Ø 5 mm	32
1 Flachmeißel, mit Hohlprofil 200 mm	35
17 Ring-Maulschlüssel 6÷22 mm	42
8 Doppeldmaulschlüssel 6x7 - 8x9 - 10x11 - 12x13 - 14x15 - 16x17 - 18x19 - 20x22 mm	55
9 Sechskant-Stiftschlüssel, gebogen ○ 1,5 - 2 - 2,5 - 3 - 4 - 5 - 6 - 8 - 10 mm	96N/SC9
11 Sechskant - Stiftschlüssel mit Griff ○ 2÷10 mm	96T/SP11
13 Stiftschlüssel, gebogen, für Torx® - Schrauben ○ T6÷T50	97TX/B13
1 Einmaulschlüssel, verstellbar 300 mm	111E
13 Sechskant - Steckschlüssel, 1/2", mit Halter ○ 10÷22 mm	920A/SB13
1 Verlängerung, 1/2" 125 mm	920/21
1 Verlängerung, 1/2" 255 mm	920/22
1 Kardangelenk, 1/2"	920/25
1 Gleitgriff, 1/2"	920/42
1 Einfachknarre, 1/2" Ⓞ	920/50
6 Sechskant - Gelenksteckschlüssel mit T - Griff ○ 8 - 10 - 12 - 13 - 17 - 19 mm	952
1 Hebeleisen mit Griff 450 mm	965
2 Zangen mit geraden Backen für Sicherungsringe mit Innenspannung ○ 180 - 225 mm	1032
2 Zangen mit um 90° gebogenen Backen für Sicherungsringe mit Innenspannung ○ 170 - 210 mm	1034
2 Zangen mit geraden Backen für Sicherungsringe mit Außenspannung ● 175 - 225 mm	1036
2 Zangen mit um 90° gebogenen Backen für Sicherungsringe mit Außenspannung ● 175 - 220 mm	1038
1 Verstellbare Zangen 250 mm	1048N
1 Gripzange, verstellbar 240 mm	1057A
1 Diagonalseitenschneider für geringen Kraftaufwand, Griffe aus Bimaterial, Industrie-Finish ≧ 200 mm	1084GBM
1 Hebelvorschneider, schwere Ausführung ≧ 200 mm	1092V
1 Figureschere, amerikanisches Modell 250 mm	1112
1 Elektrikerschere, gerade Schneiden	1128BMX
1 Universalzangen für geringen Kraftaufwand, Griffe aus Bimaterial, Industrie-Finish ≧ 180 mm	1150GBM
4 Schraubendreher für Schlitzschrauben ● 3x75 - 4x100 - 5,5x125 - 6,5x150 mm	1260
1 Schraubendreher für Schlitzschrauben, extrakurze Klinge ● 6,5x30 mm	1260N
2 Schraubendreher für Schlitzschrauben, Klinge mit Sechskant ● 8x175 - 10x200 mm	1260E
3 Schraubendreher für Phillips®-Schrauben ⊕ PH0x100 - PH1x120 - PH2x100 mm	1262
1 Schraubendreher für Phillips® - Schrauben, extrakurze Klinge ⊕ PH2x30 mm	1262N
1 Schraubendreher für Phillips® - Schrauben, Klinge mit Sechskant, ⊕ PH3x175mm	1262E
1 Schraubendreher für Phillips® - Schrauben, lange Klinge ⊕ PH2x400 mm	1262L
1 Schraubendreher für Gewindestifte mit Schlitz, lange Klinge ● 6,5x400 mm	1264L
1 Schlosserhammer, deutsches Modell 500 g	1370
1 Hammer mit auswechselbaren Kunststoffaufsätzen Ø 45 mm	1390
1 Spannschlüssel für Ölfiltergehäuse	1491
1 Fühlerlehre	1708/20
5 Feilensatz, 5-teilig, halbschlicht, mit Griff 200 mm	1719BMA...S5
1 Sägebogen	1726BM
1 Metallölkanne mit Pumpe 200 cc	1751N

€

5904VG/3 2.670,00 059041062

Sortiment empfohlen in Kombination mit RSC24 - RSC24A - RSC24A-XL - C37 - C39 mit 7 - 8 Schubladen
RSC24L - RSC24L/CAB - C59 - RSC50 - RSC55

5904VG/3T

Werkzeugsortiment, 102-teilig, im festen Thermoformateinsatz aus ABS

► KFZ-Mechanik

Stück / Beschreibung

- 21 Ring-Maulschlüssel 6-7-8-9-10-11-12-13-14-15-16-17
18-19-20-21-22-24-27-30-32 mm
- 8 Doppelpmaulschlüssel 6x7-8x9-10x11-12x13-14x15
16x17-18x19-20x22 mm
- 9 Sechskant-Stiftschlüssel, gebogen \varnothing 1,5+10 mm
- 6 Sechskant - Stiftschlüssel mit Griff \varnothing 2-2,5-3-4-5-6 mm
- 8 Sechskant - Gelenksteckschlüssel mit T - Griff \varnothing 7-8-10-12-13-14-17-19 mm
- 19 Sechskant-Steckschlüssel, 1/2" \varnothing 10-11-12-13-14-15-16-17-18-19
20-21-22-23-24-26-27-30-32 mm
- 1 Verlängerung, 1/2" 125 mm
- 1 Verlängerung, 1/2" 255 mm
- 1 Kardangelenke, 1/2"
- 1 Gleitgriff, 1/2" 305 mm
- 1 Umschaltknarre, 1/2" \otimes
- 1 Diagonalseitenschneider für geringen Kraftaufwand ∇ 160 mm
- 1 Zange mit halbrunden Backen, extralang, gerade \equiv 180 mm
- 1 Zangen mit halbrunden Backen, gerade \bullet 160 mm
- 1 Zangen mit geraden Backen für Sicherungsringe mit Innenspannung \varnothing 180 mm
- 1 Zangen mit um 90° gebogenen Backen für Sicherungsringe mit Innenspannung \varnothing 170 mm
- 1 Zangen mit geraden Backen für Sicherungsringe mit Außenspannung \bullet 175 mm
- 1 Zangen mit um 90° gebogenen Backen für Sicherungsringe mit Außenspannung \bullet 175 mm
- 1 Gripzange, verstellbar 240 mm
- 1 Verstellbare Zangen 250 mm
- 7 Schraubendreher für Schlitzschrauben \bullet 2,5x50 -3x75 - 3,5x100 - 4x125 -5,5x100 - 5,5x150
- 6,5x150 mm
- 6 Schraubendreher für Phillips®-Schrauben \oplus PH0x60 - PH0x100 - PH1x80
PH1x120 - PH2x100 - PH2x150 mm
- 2 Flachmeißel, mit Hohlprofil 100-200 mm
- 1 Schlosserhammer, deutsches Modell 300 g
- 1 Hammer mit auswechselbaren Kunststoffaufsätzen \varnothing 35 mm
- 1 Thermoformateinsatz

Beta Nr.	TR
42	T05-T06
55	T33
96/SC9	T33
96T	T52
952	T63
920A	T83
920/21	T83
920/22	T83
920/25	T83
920/42	T83
920/55	T83
1084BM	T137
1150BM	T137
1166BM	T137
1032	T145
1034	T145
1036	T145
1038	T145
1052	T153
1048N	T153
1260	T199
1262	T202
35	T234
1370	T234
1390	T234
VP5	



T199 T202 T83



T145 T153 T137 T234



T52 T33 T05 T06



T63 VP5



5904VG/3T 1.960,00 059041510

Sortiment empfohlen in Kombination mit C24S - C24SA - C37 - C39
C24SL - C24SL/CAB - C59 - RSC50 - RSC55 - C23ST - C39T - C28 - C39SM - C39MD

5904VG/5T

Werkzeugsortiment, 153-teilig, im festen Thermoformateinsatz aus ABS

► KFZ-Mechanik

Stück / Beschreibung

- 5 Sechskant-Steckschlüssel mit Innenvierkantantrieb, 1/2" \odot 5 - 6 - 8 - 10 - 12 mm
- 1 Verlängerung, 1/2" 125 mm
- 1 Verlängerung, 1/2" 255 mm
- 1 Kardangelenk, 1/2"
- 1 Gleitgriff, 1/2"
- 1 Umschaltknarre, 1/2" \otimes
- 19 Sechskant-Steckschlüssel, 1/2" \odot 10+24 - 26 - 27 - 30 - 32 mm
- 16 Ring-Maulschlüssel 6÷21 mm
- 5 Ring-Maulschlüssel 22 - 24 - 27 - 30 - 32 mm
- 8 Sechskant - Gelenksteckschlüssel mit T - Griff \odot 7 - 8 - 10 - 12 - 13 - 14 - 17 - 19 mm
- 1 Thermoformateinsatz
- 1 Zangen mit geraden Backen für Sicherungsringe mit Innenspannung \odot 180 mm
- 1 Zangen mit um 90° gebogenen Backen für Sicherungsringe mit Innenspannung \odot 170 mm
- 1 Zangen mit geraden Backen für Sicherungsringe mit Außenspannung \bullet 175 mm
- 1 Zangen mit um 90° gebogenen Backen für Sicherungsringe mit Außenspannung \bullet 175 mm
- 7 Schraubendreher für Phillips®-Schrauben \bullet 2,5x50 - 3x75 - 3,5x100 - 4x125 - 5,5x100 - 5,5x150 - 6,5x150 mm
- 5 Stiftschlüssel mit Griff, für Torx®-Schrauben \odot T25 - T27 - T30 - T40 - T45
- 6 Sechskant - Stiftschlüssel mit Griff \odot 2 - 2,5 - 3 - 4 - 5 - 6 mm
- 8 Doppelmaulschlüssel 6x7 - 8x9 - 10x11 - 12x13 - 14x15 - 16x17 - 18x19 - 20x22 mm
- 9 Sechskant-Stiftschlüssel, gebogen \odot 1,5 - 2 - 2,5 - 3 - 4 - 5 - 6 - 8 - 10 mm
- 3 Schraubendreher für Phillips®-Schrauben \bullet 8x150 - 8x200 - 10x200 mm
- 2 Schraubendreher für Schlitzschrauben, extrakurze Klinge \bullet 4x30 - 6,5x30 mm
- 6 Schraubendreher für Phillips®-Schrauben \oplus PH0x60 - PH0x100 - PH1x80 - PH1x120 - PH2x100 - PH2x150 mm
- 2 Schraubendreher für Phillips®-Schrauben \oplus PH3x150 - PH4x200 mm
- 2 Schraubendreher für Phillips®-Schrauben, extrakurze Klinge \oplus PH1x30 - PH2x30 mm
- 2 Flachmeißel, mit Hohlprofil 100 - 200 mm
- 1 Schlosserhammer, deutsches Modell 300 g
- 1 Hammer mit auswechselbaren Kunststoffaufsätzen \varnothing 35 mm
- 1 Zange mit halbrunden Backen, extralang, gerade \equiv 180 mm
- 1 Zangen mit halbrunden Backen, gerade \bullet 160 mm
- 1 Diagonalseitenschneider für geringen Kraftaufwand \leq 160 mm
- 6 Schraubeinsätze für Torx®-Schrauben \odot T6÷T15
- 8 Schraubeinsätze für Torx®-Schrauben \odot T20÷T55
- 1 Einsatzhalter für Schraubeinsätze
- 1 Einsatzhalter für Schraubeinsätze
- 6 Steckschlüssel, 1/4", für Torx®-Schrauben \odot E4+E10
- 7 Steckschlüssel mit Innenvierkantantrieb 1/2", für Torx®-Schrauben \odot E12+E24
- 3 Steckschlüssel mit Innenvierkantantrieb 1/2", für Torx®-Schrauben \odot T55L - T60 - T70L
- 1 Verstellbare Zangen 250 mm
- 1 Gripzange, verstellbar 240 mm

Beta Nr.	TR
920ME	T80
920/21	T80
920/22	T80
920/25	T80
920/42	T80
920/55	T80
920A	T80
42	T05
42	T06
952	T63
VP6	VP6
1032	T145
1034	T145
1036	T145
1038	T145
1290	T170
1297TX	T176
96T	T52
55	T33
96N/SC9	T33
1290	T171
1290N	T171
1292	T172
1292	T173
1292N	T173
35	T234
1370	T234
1390	T234
1150BM	T137
1166BM	T137
1084BM	T137
861TX	T112
866TX	T112
895/1	T112
895/6	T112
900FTX	T112
920FTX	T112
920TX	T112
1048N	T153
1052	T153



T80 T05 T06



T63 VP6



T145 T170 T176 T52



T33 T171 T172 T173



T234 T137 T112 T153



5904VG/5T 2.730,00 059041196

Sortiment empfohlen in Kombination mit RSC24 mit 7 - 8 Schubladen - RSC24A mit 7 - 8 Schubladen - RSC24A-XL - C37 mit 7 - 8 Schubladen - C39 mit 7 - 8 Schubladen - RSC24L - RSC24L/CAB - C59 - RSC23T - RSC28 - C39MD - C39SM - RSC50 - RSC55



5905VG/1

Werkzeugsortiment, 94teilig, für Karosseriewerkstätten

► KFZ-Mechanik

Stück / Beschreibung	Beta Nr.
1 Durchschläger Ø 4 mm	30
6 Ø 2 - 3 - 4 - 5 - 6 - 8 mm	31/B6N
1 Körner Ø 4 mm	32
1 Flachmeißel 150 mm	34
1 Kreuzmeißel 150 mm	36
17 Ring-Maulschlüssel 6+22 mm	42
10 Sechskant-Stiftschlüssel, gebogen ○ 1,5+12 mm	96/B10
1 Einmaulschlüssel, verstellbar, mit Messskala, phosphatiert 300 mm	111EN
12 Steckschlüssel mit Griff, lange Ausführung ○ 4+14 mm	943BX
1 Hebeleisen mit Griff 450 mm	965
1 Verstellbare Zangen 250 mm	1048N
1 Gripzange, verstellbar 240 mm	1052
1 Gripzange, verstellbar zum Lichtbogenschweißen 280 mm	1060AL
1 Diagonalseitenschneider für geringen Kraftaufwand, Griffe aus Bimaterial, Industrie-Finish ☒ 160 mm	1084GBM
1 Flechterzange 250 mm	1098PL
1 Hebefigurenschere geradeschneidend	1122
1 Elektrikerschere, gerade Schneiden	1128BMX
1 Universalzangen für geringen Kraftaufwand, Griffe aus Bimaterial, Industrie-Finish ☒ 180 mm	1150GBM
1 Schraubendreher für Dzus®-Schrauben ●	1201E/DZ
4 Schraubendreher für Schlitzschrauben ● 3x75 - 4x100 - 5,5x150 - 6,5x150 mm	1260
1 Schraubendreher für Schlitzschrauben, extrakurze Klinge ● 4x30 mm	1260N
2 Schraubendreher für Schlitzschrauben, Klinge mit Sechskant ● 10x175 - 12x200 mm	1260E
3 Schraubendreher für Phillips®-Schrauben ☉ PH0x60 - PH1x80 - PH2x100 mm	1262
1 Schraubendreher für Phillips® - Schrauben, extrakurze Klinge ☉ PH1x30 mm	1262N
1 Schraubendreher für Phillips® - Schrauben, Klinge mit Sechskant, ☉ PH3x175 mm	1262E
7 Stiftschlüssel für Torx®-Schrauben ☉ T6 - T8 - T10 - T15 - T20 - T25 - T30	1267TX
1 Handfaust für Kanten 1350 g	1303
1 Handfaust, Zehenform	1305
1 Handfaust, Absatzform	1306
1 Handfaust, Schienenform	1310
1	1314
1 Löffeleisen	1326
1 Löffeleisen, schwere Ausführung	1327
1 Hebeleisen, breit	1330
1 Karosseriefeile 9"	1338A
1 Flachmeißel, extradünn mit Handschutz	1342PM
1 Planierhammer, runder gewölbter Kopf und Pinne	1345
1 Schlichthammer, flache Köpfe Ø 40 mm	1357Z/45
1 Schlosserhammer, deutsches Modell 300 g	1370
1 Hammer mit auswechselbaren Kunststoffaufsätzen Ø 35 mm	1390
1 Rollbandmaß 5 m	1692

€

5905VG/1 2.420,00 059051058

Sortiment empfohlen in Kombination mit C25



5905VG/2 Werkzeugsortiment, 118teilig

► KFZ-Mechanik

Stück / Beschreibung	Beta Nr.
6 Satz aus 2 Durchschlägern, 1 Körner, 2 Flachmeißeln und 1 Kreuzmeißel, in Werkzeugrolle aus Polyester	38/B6N
13 Ring-Maulschlüssel 6+14 - 17 - 19 - 22 - 24 mm	42
13 Doppelmaulschlüssel 6x7 - 8x9 - 10x11 - 12x13 - 14x15 - 16x17 - 18x19 - 20x22 - 21x23 - 24x26 - 25x28 - 27x29 - 30x32 mm	55
3 Starterschlüssel 11x13 - 14x17 - 19x22 mm	83
10 Sechskant-Stiftschlüssel, gebogen \odot 1,5+12 mm	96N/B10
6 Stiftschlüssel mit Griff, für Torx®-Schrauben \odot T10 - T15 - T20 - T25 - T30 - T40	97TTX
2 Kraftsteckschlüssel, 1/2" \odot 17 - 19 mm	720
20 Sechskant-Steckschlüssel, 1/2" \odot 10+24 - 26 - 27 - 28 - 30 - 32 mm	920A
1 Verlängerung, 1/2" 125 mm	920/21
1 Verlängerung, 1/2" 255 mm	920/22
1 Kardangelenk, 1/2"	920/25
1 Gleitgriff, 1/2"	920/42
1 Umschaltknarre, 1/2" \otimes	920/55
8 Sechskant - Gelenksteckschlüssel mit T - Griff \odot 7 - 8 - 10 - 11 - 13 - 14 - 17 - 19 mm	952
1 Zündkerzenschlüssel mit Gelenk, normale Ausführung	959
1 Kreuzschlüssel für Radmutter \odot 17x19x22x 1/2"	979
1 Zangen mit geraden Backen für Sicherungsringe mit Innenspannung \odot 180 mm	1032
1 Zangen mit um 90° gebogenen Backen für Sicherungsringe mit Innenspannung \odot 170 mm	1034
1 Zangen mit geraden Backen für Sicherungsringe mit Außenspannung \bullet 175 mm	1036
1 Zangen mit um 90° gebogenen Backen für Sicherungsringe mit Außenspannung \bullet 175 mm	1038
1 Verstellbare Zangen 250 mm	1048N
1 Gripzange, verstellbar 240 mm	1052
1 Diagonalseitenschneider für geringen Kraftaufwand, Griffe aus Bimaterial, Industrie-Finish ∇ 160 mm	1084GBM
1 Hebelfigureschere geradeschneidend 250 mm	1122
1 Elektrikerschere, gerade Schneiden	1128BMX
1 Universalzangen für geringen Kraftaufwand, Griffe aus Bimaterial, Industrie-Finish \equiv 180 mm	1150GBM
1 Zangen mit halbrunden Backen, extralang, gerade, innengeriffelt, Griffe aus Bimaterial, Industrie-Finish \bullet 160 mm	1166GBM
8 Schraubendreher für Schlitzschrauben \bullet 2,5x50 - 3x75 - 3,5x100 - 4x125 - 5,5x125 - 6,5x150 - 8x200 - 10x200 mm	1260
2 Schraubendreher für Schlitzschrauben, Klinge mit Sechskant \bullet 10x200 - 12x250 mm	1260E
1 Schraubendreher für Schlitzschrauben, extrakurze Klinge \bullet 6,5x30 mm	1260N
4 Schraubendreher für Phillips®-Schrauben \oplus PH0x60 - PH1x80 - PH2x100 - PH3x150 mm	1262
1 Schlosserhammer, deutsches Modell 400 g	1370
1 Hammer mit auswechselbaren Kunststoffaufsätzen \varnothing 35 mm	1390
1 Spannschlüssel für Ölfiltergehäuse	1491
1 Spannungsprüfer 3+48 V	1498

€

5905VG/2 2.260,00 059051044

Sortiment empfohlen in Kombination mit C25

5908VG/2T

Werkzeugsortiment, 214-teilig, im festen Thermoformateinsatz aus ABS

► KFZ-Mechanik

Stück / Beschreibung

Beta Nr. TR



- 16 Ring-Maulschlüssel 6+21 mm 42 T05
- 5 Ring-Maulschlüssel 22 - 24 - 27 - 30 - 32 mm 42 T06
- 5 Splinttreiber Ø 2 - 3 - 4 - 5 - 6 mm 31 T31
- 1 Körner Ø 4 mm 32 T31
- 12 Doppelmaulschlüssel 6x7 - 8x9 - 10x11 - 12x13 - 14x15 - 16x17 55 T31
- 18x19 - 20x22 - 21x23 - 24x26 - 27x29 - 30x32 mm
- 9 Sechskant-Stiftschlüssel, gebogen ○ 1,5 - 2 - 2,5 - 3 - 4 - 5 - 6 - 8 - 10 mm 96N/SC9 T31
- 5 Sechskant-Steckschlüssel mit Innenvierkantantrieb, 1/2" ○ 5 - 6 - 8 - 10 - 12 mm 920ME T80
- 1 Verlängerung, 1/2" 125 mm 920/21 T80
- 1 Verlängerung, 1/2" 255 mm 920/22 T80
- 1 Kardangelenk, 1/2" 920/25 T80
- 1 Gleitgriff, 1/2" 920/42 T80
- 1 Umschaltknarre, 1/2" ⊕ 920/55 T80
- 19 Sechskant-Steckschlüssel, 1/2" ○ 10+24 - 26 - 27 - 30 - 32 mm 920A T80
- 1 Zangen mit geraden Backen für Sicherungsringe mit Innenspannung ○ 180 mm 1032 T145
- 1 Zangen mit um 90° gebogenen Backen für Sicherungsringe mit Innenspannung ○ 170 mm 1034 T145
- 1 Zangen mit geraden Backen für Sicherungsringe mit Außenspannung ● 175 mm 1036 T145
- 1 Zangen mit um 90° gebogenen Backen für Sicherungsringe mit Außenspannung ● 175 mm 1038 T145
- 1 Zangen mit geraden Backen für Sicherungsringe mit Innenspannung ○ 140 mm 1032 T146
- 1 Zangen mit geraden Backen für Sicherungsringe mit Innenspannung ○ 225 mm 1032 T146
- 1 Zangen mit geraden Backen für Sicherungsringe mit Außenspannung ● 140 mm 1036 T146
- 1 Zangen mit geraden Backen für Sicherungsringe mit Außenspannung ● 225 mm 1036 T146
- 9 Schraubendreher für Schlitzschrauben ● 3x75 - 3x100 - 4x100 - 4x150 - 5,5x100 - 5,5x150 - 6,5x150 - 8x150 - 10x200 mm 1260 T167
- 2 Schraubendreher für Schlitzschrauben, extrakurze Klinge ● 4x30 - 6,5x30 mm 1260N T167
- 7 Schraubendreher für Phillips®-Schrauben ⊕ PH0x60 - PH0x100 - PH1x80 - PH1x120 - PH2x100 - PH2x150 - PH3x150 mm 1262 T168
- 2 Schraubendreher für Phillips® - Schrauben, extrakurze Klinge ⊕ PH1x30 - PH2x30 mm 1262N T168
- 8 Sechskant - Gelenksteckschlüssel mit T - Griff ○ 7 - 8 - 10 - 12 - 13 - 14 - 17 - 19 mm 952 T63
- 2 Schraubendreher für Phillips® - Schrauben, lange Klinge ⊕ PH1x400 - PH2x400 mm 1262L T209
- 3 Schraubendreher für Gewindestifte mit Schlitz, lange Klinge ● 3x300 - 4x400 - 5x400 mm 1264L T209
- 6 Stiftschlüssel mit Griff, für Torx®-Schrauben ○ T10-T15-T20-T25-T27-T30 97TTX T55
- 12 Kraftsteckschlüssel, 1/2" ○ 10-13-17-18-19-21-22-24-27-30-32 mm 720 T111
- 1 Verlängerung, Innen- und Außenvierkant 1/2" 125 mm 720/21 T111
- 3 ○ 17-19-21 720LC T111
- 5 Farbige Sechskant-Schraubeinsätze 1/2" ○ 5L - 6L - 7L - 8L - 10L 920PE T113
- 4 Steckschlüssel mit Innenvierkantantrieb 1/2", für Torx®-Schrauben 920TX T113
- T40L - T45L - T55L - T70L
- 3 Steckschlüssel für Vielzahnschrauben (XZN®) ○ M6L - M8L - M12L 920XZN T113
- 5 Feilen für normale Bearbeitung 200 mm 1719BMA8/S5 T236
- 1 Spannschlüssel für Ölfiltergehäuse 110 mm 1491 T264
- 1 Steckschlüssel-Einsätze für Ölwanne, Viereckantrieb ■ 10 mm 1494 T264
- 7 Steckschlüssel-Einsätze für Ölwanne, Außensechskant ○ 8-9-10-11-12-14-17 mm 1494E T264
- 4 Steckschlüssel-Einsätze für Ölwanne, Außenviereckantrieb ○ 8-9-5-12-13 mm 1494Q T264
- 1 Steckschlüssel-Einsatz für Ölwanne, Außendreieckantrieb Δ 1494T T264
- 1 Steckschlüsseleinsatz für Ölwanne für Vielzahnschrauben (XZN®) ○ 1494XZN T264
- 1 Ölwanenschlüssel 1496C T264
- 2 Flachmeißel, mit Hohlprofil 100 - 200 mm 35 T234
- 1 Schlosserhammer, deutsches Modell 300 g 1370 T234
- 1 Hammer mit auswechselbaren Kunststoffaufsätzen Ø 35 mm 1390 T234
- 1 Verstellbare Zangen 250 mm 1048N T153
- 1 Grijpzange, verstellbar 240 mm 1052 T153
- 1 Zange mit halbrunden Backen, extralang, gerade = 180 mm 1150 T138
- 1 Zangen mit halbrunden Backen, gerade ● 160 mm 1166 T138
- 1 Diagonalseitenschneider für geringen Kraftaufwand ✂ 160 mm 1084 T138
- 11 Sechskant - Steckschlüssel, 3/4" ○ 22-24-27-30-32-34-36-38-41-46-50 mm 928A T105
- 1 Verlängerung, 3/4" 200 mm 928/21 T106
- 1 Verlängerung, 3/4" 380 mm 928/22 T106
- 1 Gleitgriff, 3/4" 450 mm 928/42 T106
- 1 Umschaltknarre, 3/4" ⊕ 928/55 T106
- 1 Thermoformateinsatz VP6 VP6
- 4 Sechskant-Stiftschlüssel, gebogen ○ 13-14-17-19 mm 96N T106
- 1 Einmaulschlüssel, verstellbar 300 mm 111E T106
- 1 Hebeleisen mit Griff 965 T106
- 1 Figureschere, amerikanisches Modell 250 mm 1112 T106
- 1 Elektrikerschere, gerade Schneiden 1128BMX T106
- 1 Schlosserhammer, deutsches Modell 1000 g 1370 T106
- 1 Fühlerlehre 1708/20 T106
- 1 Magnetheber, flexibel 1712 T106
- 1 Inspektionsspiegel, teleskopisch 1715 T106
- 1 Dreikantschaber 200 mm 1717B T106
- 1 Sägebogen 440 mm 1726 T106
- 1 Stahldrahtbürste 1737NX T106
- 1 Metalllölkanne mit Pumpe 200 cl 1751N T106
- 1 Cutter 1771 T106

5908VG/2T

€ 4.600,00 059081017

Sortiment empfohlen in Kombination mit RSC28

5935VG/1MB

Werkzeugsortiment, 98-teilig, für Werkzeugkasten C35, im Schaumstoffeinsatz aus EVA



MB12



MB39



MB46

► KFZ-Mechanik

Stück / Beschreibung

- 21 Ring-Maulschlüssel 6-7-8-9-10-11-12-13-14-15-16-17-18-19-20-21-22-24-27-30-32 mm
- 8 Doppelmaulschlüssel 6x7-8x9-10x11-12x13-14x15
- 16x17-18x19-20x22 mm
- 1 Verstellbare Zangen 250 mm
- 4 Schraubendreher für Schlitzschrauben ● 3x75-4x100-5x125-6,5x150 mm
- 3 Schraubendreher für Phillips®-Schrauben ● PH0x60-PH1x80--PH2x100 mm
- 6 Stiftschlüssel für Torx®-Schrauben ⦿ T8-T10-T15-T20-T25-T30
- 9 Sechskant - Stiftschlüssel, gebogen, mit kugelförmigem Kopf ○
- 6 Sechskant - Stiftschlüssel mit Griff ○ 2-2,5-3-4-5-6
- 1 Gripzange, verstellbar 240 mm
- 19 Sechskant-Steckschlüssel, 1/2" ○ 10-11-12-13-14-15-16-17
- 18-19-20-21-22-23-24-26-27-30-32 mm
- 1 Verlängerung, 1/2" 125 mm
- 1 Verlängerung, 1/2" 250 mm
- 1 Kardangelenk, 1/2"
- 1 Gleitgriff, 1/2"
- 1 Umschaltknarre, 1/2" ⦿
- 5 Farbige Sechskant-Schraubeinsätze 1/2" ○ 5-6-8-10-12 mm
- 1 Zangen mit geraden Backen für Sicherungsringe mit Innenspannung ○ 180 mm
- 1 Zangen mit um 90° gebogenen Backen für Sicherungsringe mit Innenspannung ○ 170 mm
- 1 Zangen mit geraden Backen für Sicherungsringe mit Außenspannung ● 175 mm
- 1 Zangen mit um 90° gebogenen Backen für Sicherungsringe mit Außenspannung ● 175 mm
- 1 Flachmeißel, mit Hohlprofil 200 mm
- 1 Diagonalseitenschneider für geringen Kraftaufwand ≤ 160 mm
- 1 Zange mit halbrunden Backen, extralang, gerade = 180 mm
- 1 Zangen mit halbrunden Backen, gerade ● 160 mm
- 1 Schlosserhammer, deutsches Modell 500 g
- 1 Hammer mit auswechselbaren Kunststoffaufsätzen 35 mm

Beta Nr.	TR
42	MB12
55	MB12
1048N	MB12
1260	MB46
1262	MB46
1267TX	MB46
96BPC/SC9	MB46
96T	MB46
1052	MB46
920A	MB39
920/21	MB39
920/22	MB39
920/25	MB39
920/42	MB39
920/55	MB39
920PE	MB39
1032	MB39
1034	MB39
1036	MB39
1038	MB39
35	MB39
1084BM	MB39
1150BM	MB39
1166BM	MB39
1370	MB39
1390	MB39

€

5935VG/1MB 1.925,00 059351321

Sortiment empfohlen in Kombination mit C35

5940SBK

Werkzeugsortiment, 125-teilig

► Motorradreparaturen

Stück / Beschreibung

- 1 Durchschläger Ø 2 mm
- 1 Körner Ø 4 mm
- 1 Flachmeißel 125 mm
- 10 Ring-Maulschlüssel 6 - 7 - 8 - 10 - 11 - 12 - 13 - 14 - 17 - 19 mm
- 6 Doppelmaulschlüssel 6x7 - 8x9 - 10x11 - 12x13 - 14x15 - 16x17 mm
- 9 Sechskant-Stiftschlüssel, gebogen ○ 1,5 - 2 - 2,5 - 3 - 4 - 5 - 6 - 8 - 10 mm
- 1 Drehmomentschlüssel mit Signalgebung ZERO-RESET ⦿ 3/8", 10+50 Nm
- 54 Sortiment mit 52 Sechskant - Schraubeinsätzen, 10 mm, und 2 Betätigungswerkzeugen
- 17 Sortiment mit 12 Steckschlüsseln und 5 Betätigungswerkzeugen
- 1 Reduzierstück, Außenvierkant 1/2", Innenvierkant 3/8"
- 2 Zündkerzeneinsatz ○ 14 - 16 mm
- 1 Zange mit halbrunden Backen, extralang ● 283 mm
- 2 Zangen mit geraden Backen für Sicherungsringe mit Innenspannung ○ 140 - 180 mm
- 1 Zangen mit geraden Backen für Sicherungsringe mit Außenspannung ● 140x1,3 mm
- 1 Diagonalseitenschneider, Griffe mit zweischichtigem Überzug aus rutschfestem PVC, Industrie-Finish ≤ 160 mm
- 1 Elektrikerschere, gerade Schneiden
- 1 Universalzangen für geringen Kraftaufwand, Griffe mit zweischichtigem Überzug aus rutschfestem PVC, Industrie-Finish = 180 mm
- 1 Schraubendreher für Dzus®-Schrauben ●
- 4 Schraubendreher für Schlitzschrauben ● 3x75 - 4x100 - 5,5x100 - 6,5x150 mm
- 3 Schraubendreher für Phillips®-Schrauben ● PH0x60 - PH1x80 - PH2x100 mm
- 1 Schraubendreher mit Spannungsprüfer ●
- 1 Schlosserhammer, deutsches Modell 300 g
- 1 Spannschlüssel für Ölfiltergehäuse
- 1 Fühlerlehre
- 1 Minisägebogen
- 1 Messingdrahtbürste
- 1 Kunststoffölkanne mit Pumpe 250 cc

Beta Nr.
30
32
34
42
55
96/SC9
666/5
867/C52
920A/C12X
910/16
956C
1009L/A
1032
1036
1082G
1128BM
1150G
1201E/DZ
1201E
1202E
1254
1370
1491
1708/13
1725CR
1737
1754

€

5940SBK 1.445,00 059401082

Sortiment empfohlen in Kombination mit Artikeln C41S - C41H - C42S - C42H - C42S - C41S

5941VU/M

Werkzeugsortiment, 64-teilig, für Trolley C41H, im Schaumstoffeinsatz aus EVA

► Universalsortimente

Stück / Beschreibung

- 16 Ring-Maulschlüssel 6-7-8-9-10-11-12-13-14-15-16-17-18-19-21-22 mm
- 9 Sechskant-Stiftschlüssel, gebogen ○
- 1 Rollbandmaß 5 m
- 19 Sechskant-Steckschlüssel, 1/2"
 - 10-11-12-13-14-15-16-17-18-19-20-21-22-23-24-26-27-30-32 mm
- 1 Kardangelenke, 1/2"
- 1 Gleitgriff, 1/2"
- 1 Umschaltknarre, 1/2" ⊕
- 2 Verlängerung, schwenkbar - 1/2" 125-250 mm
- 1 Einmaulschlüssel, verstellbar 250 mm
- 1 Verstellbare Zangen 250 mm
- 1 Diagonalseitenschneider, Griffe aus Bimaterial, Industrie-Finish ⚡ 160 mm
- 1 Elektrikerschere, gerade Schneiden 145 mm
- 1 Universalzangen für geringen Kraftaufwand, Griffe aus Bimaterial, Industrie-Finish ≡ 180 mm
- 1 Zangen mit halbrunden Backen, extralang, gerade, innengeriffelt, Griffe aus Bimaterial, Industrie-Finish ● 160 mm
- 3 Schraubendreher für Schlitzschrauben ● 3,5x100-5,5x125-6,5x150 mm
- 3 Schraubendreher für Phillips®-Schrauben ⊕ PH0-PH1-PH2
- 1 Schlosserhammer, deutsches Modell 300 g
- 1 Cutter 18 mm

Beta Nr.	TR
42	MC12
96/SC9	MC12
1692/5	MC12
920A	MC21
920/25	MC21
920/42	MC21
920/55	MC21
920AN	MC21
111E	
1048N	
1082GBM	
1128BMX	
1150GBM	
1166GBM	
1260	
1262	
1370	
1771	



MC21



MC12



5941VU/M

€ 968,00 059411002

Sortiment empfohlen in Kombination mit Art. C9 - C10 - C10S - C11 - CP15 - CP15PL - C16 - CP17 CP17L - C18

 **Beta**

► **Universalsortimente****Stück / Beschreibung**

- 21 Ring-Maulschlüssel 6-7-8-9-10-11-12-13-14-15-16-17-18-19-20-21-22-24-27-30-32 mm
 9 Sechskant - Stiftschlüssel, gebogen, mit kugelförmigem Kopf ○ 1,5-2-2,5-3-4-5-6-8-10 mm
 1 Einsatzhalter für Schraubeinsätze ○ 1/4 - □ 1/4
 1 Einsatzhalter für Schraubeinsätze ○ 1/4 - □ 3/8
 1 Einsatzhalter für Schraubeinsätze ○ 5/16 - □ 1/2
 13 Sechskant-Steckschlüssel, 1/4" ○ 4-4,5-5-5,5-6-7-8-9-10-11-12-13-14 mm
 9 Sechskant-Steckschlüssel, lange Ausführung ○ 5-6-7-8-9-10-11-12-13 mm
 5 Sechskant-Steckschlüssel 1/4" ○ 3-4-5-6-7 mm
 4 Schraubendrehereinsätze für Schlitzschrauben ● 0,8x4-1x5,5x1,2x6,5-1,2x8 mm
 4 Schraubendrehereinsätze für Phillips®-Schrauben ● PH1-PH2-PH3-PH4
 7 Steckschlüssel für Torx®-Schrauben ○ T10-T15-T20-T25-T27-T30-T40
 1 Verbindungsstück, Innenvierkant 1/4", Außenvierkant 3/8" □ 1/4 - ■ 3/8
 1 Verlängerung, - 1/4" 50 mm
 1 Verlängerung, - 1/4" 100 mm
 1 Verlängerung, - 1/4" 150 mm
 1 Kardangelenke, 1/4"
 1 Steckgriff, 1/4" 176 mm
 1 Gleitgriff, 1/4" 115 mm
 1 Umschaltknarre, 1/4" ● 125 mm
 17 Sechskant - Steckschlüssel 3/8" ○ 6-7-8-9-10-11-12-13-14-15-16-17-18-19-20-21-22 mm
 1 Reduzierstück, Innenvierkant 3/8", Außenvierkant 1/4" □ 3/8 - ■ 1/4
 1 Reduzierstück, Außenvierkant 1/2", Innenvierkant 3/8" □ 3/8 - ■ 1/2
 1 Verlängerung - 3/8" 125 mm
 1 Verlängerung - 3/8" 250
 1 Kardangelenke, Innen- und Außenvierkant 3/8"
 1 Gleitgriff, Außenvierkant 3/8" 210 mm
 1 Umschaltknarre mit Außenvierkantantrieb 3/8" ● 200 mm
 21 Sechskant-Steckschlüssel, 1/2" ○ 8-10-11-12-13-14-15-16-17-18-19-20-21-22-23-24-26-27-28-30-32 mm
 1 Reduzierstück, Innenvierkant 1/2", Außenvierkant 3/8" □ 1/2 - ■ 3/8
 1 Kardangelenke, 1/2"
 1 Verlängerung, schwenkbar - 1/2" 125 mm
 1 Verlängerung, schwenkbar - 1/2" 250 mm
 1 Gleitgriff, 1/2" 305 mm
 1 Umschaltknarre, 1/2" ● 275 mm
 3 Zündkerzeneinsätze, 3/8" ○ 16 mm (5/8")-17,8 (11/16")-20,8 (13/16")
 6 Schraubendreher für Schlitzschrauben ● 0,4x2,5x50-0,5x3x75-0,8x4x100-1,0x5,5x125-1,2x6,5x150-1,2x8x200 mm
 1 Schraubendreher für Schlitzschrauben, extrakurze Klinge ● 0,8x4x30 mm
 4 Schraubendreher für Phillips®-Schrauben ● PH0x60-PH1x80PH2x100PH3x150 mm
 1 Schraubendreher für Phillips®-Schrauben, extrakurze Klinge ● PH1x30 mm
 12 Stiftschlüssel mit Griff, für Torx®-Schrauben ○ T06-T07-T08-T09-T10-T15-T20-T25-T27-T30-T40-T45
 1 Schraubendreher mit Spannungsprüfer ● 0,5x3,5x100 mm
 1 Zangen mit geraden Backen für Sicherungsringe mit Innenspannung ○ 180 mm
 1 Zangen mit um 90° gebogenen Backen für Sicherungsringe mit Innenspannung ○ 170 mm
 1 Zangen mit geraden Backen für Sicherungsringe mit Außenspannung ● 175 mm
 1 Zangen mit um 90° gebogenen Backen für Sicherungsringe mit Außenspannung ● 175 mm
 1 Verstellbare Zangen 250 mm
 1 Gripzange, verstellbar 240 mm
 1 Gripzange, verstellbar 240 mm
 1 Diagonalseitenschneider ≧ 160 mm
 1 Flechterzangen 220 mm
 1 Elektrikerschere, gerade Schneiden
 1 Zange mit halbrunden Backen, extralang, gerade ≧ 180 mm
 1 Zangen mit halbrunden Backen, gerade ● 160 mm
 3 Durchschläger Ø 2-3-4 mm
 6 Splinttreiber Ø 2-3-4-5-6-8 mm
 1 Körner Ø 4 mm
 1 Flachmeißel 150 mm
 2 Flachmeißel, mit Hohlprofil 200-250 mm
 1 Kreuzmeißel 125 mm
 1 Schlosserhammer, deutsches Modell 500 g
 1 Hammer mit austauschbaren Kunststoffaufsätzen Ø 35 mm
 1 Rollbandmaß 3 m
 1 Teleskopmagnetheber mit flexiblen Kopf
 1 Vierkantfeilen halbschlicht 200 mm
 1 Dreieckfeilen, halbschlicht 200 mm
 1 Flachfeilen halbschlicht 200 mm
 1 Halbrundfeilen halbschlicht 200 mm
 1 Rundfeilen halbschlicht 200 mm
 1 Stahldrahtbürste
 1 Cutter

Beta Nr.	TR
	42
96BPC/SC9	MM11
895/1	MM105
895/3	MM105
895/6	MM105
900	MM105
900L	MM105
900ME	MM105
900LP	MM105
900PH	MM105
900TX	MM105
900/16	MM105
900/20	MM105
900/20L	MM105
900/21	MM105
900/25	MM105
900BG/30	MM105
900/42	MM105
900/55	MM105
910A	MM105
910/15	MM105
910/16	MM105
910/21	MM105
910/22	MM105
910/25	MM105
910/42	MM105
910/55	MM105
920A	MM105
920/15	MM105
920/25	MM105
920AN	MM105
920AN	MM105
920/42	MM105
920/55	MM105
956E	MM105
1201E	MM210
1201EN	MM210
1202E	MM210
1202EN	MM210
1207E/7X	MM210
1253	MM210
1032	MM129
1034	MM129
1036	MM129
1038	MM129
1048N	MM129
1052	MM129
1052	MM129
1082BM	MM129
1098	MM129
1128BM	MM129
1150BM	MM129
1166BM	MM129
30	MM230
31	MM230
32	MM230
34	MM230
35	MM230
36	MM230
1370	MM230
1390	MM230
1692	MM230
1712TF	MM230
1719BMA...Q	MM230
1719BMA...T	MM230
1719BMA...P	MM230
1719BMA...M	MM230
1719BMA...R	MM230
1737NX	MM230
1771	MM230



MM11



MM105



MM129



MM210



MM230



5945VUM

3.130,00 059451011

Sortiment empfohlen in Kombination mit C45



5954VG

Werkzeugsortiment, 138teilig

► KFZ-Mechanik

Stück / Beschreibung	Beta Nr.
5 Splinttreiber Ø 2-3-4-5-6 mm	31
1 Körner Ø 4 mm	32
1 Flachmeißel 125 mm	34
18 Ring-Maulschlüssel 6+22 - 24 mm	42
8 Doppelmaulschlüssel 6x7 - 8x9 - 10x11 - 12x13 - 14x15 - 16x17 - 18x19 - 20x22 mm	55
3 Doppelringschlüssel, tief gekröpft 12x13 - 14x15 - 17x19 mm	90
13 Sechskant-Stiftschlüssel, gebogen ○ 2+10 - 12 mm	96
4 Kraftsteckschlüssel, 1/2" ○ 17 - 19 - 21 - 22 mm	720
20 Sechskant-Steckschlüssel, 1/2" ○ 10-11-12-13-14-15-16-17-18-19-20-21-22-23-24-26-27-28-30-32 mm	920A
1 Verlängerung, 1/2"	920/21
1 Verlängerung, 1/2"	920/22
1 Kardangelenk, 1/2"	920/25
1 Gleitgriff, 1/2"	920/42
1 Umschaltknarre, 1/2" ⊕	920/55
3 Steckschlüssel mit Griff, lange Ausführung ○ 8 - 10 - 13 mm	943BX
10 Sechskant - Gelenksteckschlüssel mit T - Griff ○ 6 - 7 - 8 - 10 - 11 - 12 - 13 - 14 - 17 - 19 mm	952
3 Zündkerzeneinsatz ○ 16 - 17,8 - 20,8 mm	956C
1 Hebeleisen, gebogen	964
1 Zangen mit geraden Backen für Sicherungsringe mit Innenspannung ○	1032
1 Zangen mit um 90° gebogenen Backen für Sicherungsringe mit Innenspannung ○	1034
1 Zangen mit geraden Backen für Sicherungsringe mit Außenspannung ●	1036
1 Zangen mit um 90° gebogenen Backen für Sicherungsringe mit Außenspannung ●	1038
1 Verstellbare Zangen 250 mm	1048N
1 Gripzange, verstellbar 240 mm	1052
1 Gripzange, verstellbar lange Backen 175 mm	1058
1 Diagonalseitenschneider ✂ 160 mm	1082BM
1 Elektrikerschere, gerade Schneiden	1128BMX
1 Zange mit halbrunden Backen, extralang, gerade = 180 mm	1150BM
1 Zangen mit halbrunden Backen, gerade ● 160 mm	1166BM
1 Schraubendreher mit Spannungsprüfer ● 6+24V	1254
1 Schraubendreher für Schlitzschrauben ● 8 x 200 mm	1260
1 Schraubendreher für Schlitzschrauben, extrakurze Klinge ● 6,5x30 mm	1260N
1 Schraubendreher für Phillips®-Schrauben ● 8 x 150 mm	1262
1 Schraubendreher für Phillips® - Schrauben, extrakurze Klinge ● PH2x30 mm	1262N
5 Stiftschlüssel für Torx®-Schrauben ⊕ T8 - T10 - T15 - T20 - T25	1267TX
8	1263/D8
1 Schlosserhammer, deutsches Modell 300 g	1370
1 rückschlagfreier Hammer Ø 35 mm	1392
1 Bremsfederzange für Trommelbremsen 210 mm	1470
1 Anpresszange für nichtisolierte Kabelverbindungen	1603
1 Rollbandmaß 5 m	1692
1 Fühlerlehre	1708/20
1 Magnetheber, flexibel 1,8 kg	1712E/2
6 Nadelfeilen 160 mm	1720/B6
1 Kunststoffölkanne mit Pumpe 150 cc	1754

€

5954VG 2.670,00 059541054

Sortiment empfohlen in Kombination mit C54VG



5957VG

Werkzeugsortiment, 174-teilig

► KFZ-Mechanik

Stück / Beschreibung	Beta Nr.
6 Splinttreiber Ø 2 - 3 - 4 - 5 - 6 - 8 mm	31/SP6
2 Durchschläger, 1 Körner, 3 Meißel mit Ständer	38/SP6
17 Ring-Maulschlüssel 6-7-8-10-11-12-13-14 15-16-17-19-21-22-24-27-30 mm	42
12 Doppelmaulschlüssel 6x7 ÷ 30x32 mm	55/S12X
8 Sechskant - Stiftschlüssel mit Griff 2 ÷ 10 mm	96T/S8
1 Sechskant-Stiftschlüssel, gebogen Ø 2,5 ÷ 12 mm	96N/G7
8 Stiftschlüsselsatz, 8teilig, gebogen, für Torx®-Schrauben Ⓢ T9 ÷ T40	97TX/SC8
5 Gebogene Stiftschlüssel für Vielzahnschrauben (XZN®) Ⓢ M5 ÷ M12	98XZN/B5
1 Einmaulschlüssel, verstellbar 250 mm	111E
1 Drehmomentschlüssel mit Signalgebung ZERO-RESET Ⓢ 1/2", 40÷200 Nm	666/20
13 Sechskant - Steckschlüssel, 1/2", mit Halter Ⓢ 10÷22 mm	920A/SB13
8 Sechskant - Steckschlüssel, 1/2", mit Halter Ⓢ 23÷32 mm	920A/SB8
4 Schraubendrehereinsätze für Schlitzschrauben ● 1,2x6,5 - 1,2x8 - 1,6x9 - 2x12 mm	920LP
3 Schraubendrehereinsätze für Phillips® - Schrauben Ⓢ PH2 - 3 - 4	920PH
1 Verlängerung, 1/2" 125 mm	920/21
1 Verlängerung, 1/2" 255 mm	920/22
1 Kardangelenk, 1/2"	920/25
1 Gleitgriff, 1/2"	920/42
1 Umschaltknarre, 1/2" Ⓢ	920/55
2 Kraftsteckschlüssel, 1/2" Ⓢ 17 - 19 mm	720
10 Sechskant - Gelenksteckschlüssel mit T - Griff Ⓢ 7 - 8 - 10 - 11 - 12 - 13 - 14 - 15 - 17 - 19 mm	952
3 Zündkerzenschlüssel mit Gelenk, normale Ausführung 14 - 16 - 20,8 mm	959
1 Hebeleisen, gerade	963
1 Kreuzschlüssel für Radmutter Ⓢ 1/2" - 17 - 19 - 22 mm	979
2 Zangen mit geraden Backen für Sicherungsringe mit Innenspannung Ⓢ 140 - 180 mm	1032
2 Zangen mit um 90° gebogenen Backen für Sicherungsringe mit Innenspannung Ⓢ 130 - 170 mm	1034
2 Zangen mit geraden Backen für Sicherungsringe mit Außenspannung ● 140x1,3 - 175 mm	1036
2 Zangen mit um 90° gebogenen Backen für Sicherungsringe mit Außenspannung ● 135x1,3 - 175 mm	1038
1 Verstellbare Zangen 250 mm	1048N
1 Gripzange, verstellbar 240 mm	1052
1 Diagonalseitenschneider ⚡ 160 mm	1082BM
1 Diagonalseitenschneider für geringen Kraftaufwand ⚡ 160 mm	1084BM
1 Hebelvornscheider, schwere Ausführung ⚡ 180 mm	1092V
1 Figureschere, amerikanisches Modell 250 mm	1112
1 Elektrikerschere, gerade Schneiden	1128BMX
1 Zange mit halbrunden Backen, extralang, gerade = 180 mm	1150BM
1 Zangen mit halbrunden Backen, gerade ● 160 mm	1166BM
1 Zangen mit halbrunden Backen, gebogen ● 200 mm	1168BM
2 Schraubendreher für Schlitzschrauben ● 8x200 - 10x200 mm	1260
1 Schraubendreher für Phillips®-Schrauben Ⓢ PH3x150 mm	1262
8	1263/D8
2 Schlosserhammer, deutsches Modell 300 - 600 g	1370
1 Hammer mit auswechselbaren Kunststoffaufsätzen Ø 35 mm	1390
11 Stehholzenausdreher mit Walzen M5÷M16 mm	1433/C11
1 Spannschlüssel für Ölfiltergehäuse	1491
1 Spannungsprüfer	1498
1 Rollbandmaß 5 m	1692
1 Fühlerlehre	1708/20
1 Magnetheber, flexibel 1,8 kg	1712E/2
1 Löffelschaber 200 mm	1717A
1 Dreikantschaber 200 mm	1717B
5 Feilen für normale Bearbeitung 200 mm	1719BMA8/S5
1 Sägebogen	1725
1 Metallölkanne mit Pumpe 200 cc	1751
1 Cutter	1771
1 Schieblehre	1650

€

5957VG 4.660,00 059571007

Sortiment empfohlen in Kombination mit Artikeln C57S A - C57S B - C57SP - RSC50 PS - C55PS - C55PSE

WEICHE THERMOFORMATEINSÄTZE

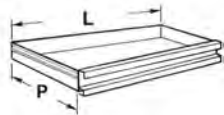

RSC23T
RSC24
RSC24A
RSC24AXL
RSC24L/7
RSC24L-CAB
RSC28
C30M
C37
C37A
C39
C39T
C39MD
C39SM
RSC51
C57S
C59
RSC55

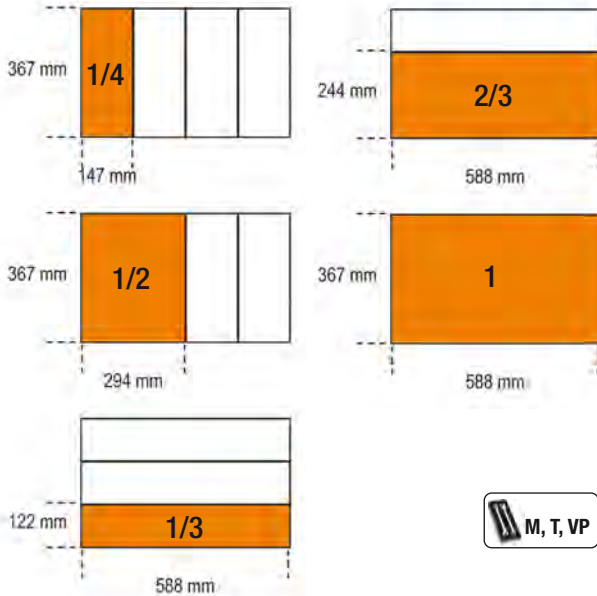

M, T, VP

533÷543
549÷558

M01



42 6 - 7 - 8 - 9 - 10 - 11 - 12 - 13 - 14 - 15
- 16 - 17 - 18 - 19 - 20 - 21 - 22 - 24 - 27
- 30 - 32 - 36 mm

4,5 kg

M01	€ 494,00	1	024500001
MV10	€ 77,00	1	024510010

M02



42 6 - 7 - 8 - 9 - 10 - 11 - 12 - 13 - 14 - 15
- 16 - 17 - 18 - 19 - 20 - 21 - 22 - 23 - 24
- 25 - 26 - 27 - 28 - 29 - 30 - 32 mm

6,3 kg

M02	€ 559,00	1	024500002
MV02	€ 77,00	1	024510002

M05



42 6-7-8-9-10-11-12
13-14-15-16-17
18-19-20-21 mm

1,5 kg

M05	€ 243,50	1	024500005
MV15	€ 40,00	1	024510015

M06



42 22-24-27-30-32 mm

2,1 kg

M06	€ 172,00	1	024500006
MV16	€ 55,00	1	024510016

M13



42SLIM 8-10-11-12
13-14-15-16-17
18-19 mm

1,2 kg

M13	€ 182,00	1	024500013
MV13	€ 40,00	1	024510013

M25



42 6 - 7 - 8 - 9 - 10 - 11 - 12 - 13 - 14 - 15 -
16 - 17 - 18 - 19 - 21 - 22 - 24 - 27 mm
90 6x7 - 8x9 - 10x11 - 12x13 - 14x15 - 16x17
- 18x19 mm
123Q1/4
123Q3/8
123Q1/2
142 8 - 9 - 10 - 11 - 12 - 13 - 14 - 15 - 16 - 17
- 18 - 19 mm

5,1 kg

M25	€ 806,00	1	024500025
MV25	€ 77,00	1	024510873

M30



55 6x7 - 8x9 - 10x11 - 12x13 - 14x15 - 16x17
- 18x19 - 20x22 - 21x23 - 24x27 - 30x32
mm
90 6x7 - 8x9 - 10x11 - 12x13 - 14x15 - 16x17
- 18x19 - 20x22 - 21x23 - 24x27 - 30x32
mm
O96BPC/SC9 1,5 - 2 - 2,5 - 3 - 4 - 5 - 6 - 8 - 10 mm

4,2 kg

M30	€ 470,00	1	024500030
MV30	€ 77,00	1	024510030



M31

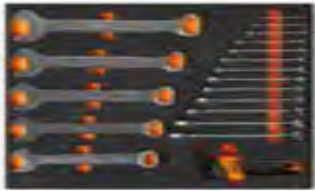

42AS 1/4 - 9/32 - 5/16 - 3/8 - 7/16 - 1/2 - 9/16
- 19/32 - 5/8 - 11/16 - 3/4 - 13/16 - 7/8 -
15/16 - 1 - 1.1/16 - 1.1/8 - 1.1/4
○ 96BPI/AS-SC9 1/16 - 3/32 - 1/8 - 5/32 - 3/16 - 7/32 - 1/4
- 5/16 - 3/8

4,5 kg



M31	492,00	1	024500031
MV31	77,00	1	024510031

M33



55 6x7-8x9-10x11
12x13-14x15
16x17-18x19
20x22 mm
○ 96/SC9 1,5+10 mm

1,1 kg



M33	114,00	1	024500033
MV33	40,00	1	024510033

M38



55 21x23-24x26
27x29-30x32 mm

1,7 kg



M38	96,50	1	024500038
MV38	55,00	1	024510038

M39



31 2-3-4-5-6-8 mm
32 4 mm
55 6x7 - 8x9 - 10x11 - 12x13 - 14x15 - 16x17
- 18x19 - 20x22 - 21x23 - 24x26 - 25x28
- 27x29 - 30x32 mm
○ 96/SC12 2 - 2,5 - 3 - 3,5 - 4 - 4,5 - 5 - 6 - 7 - 8 - 9
- 10 mm
○ 96 12-14-17-19 mm

5,7 kg



M39	388,00	1	024500039
MV39	77,00	1	024510039

M40



90 6x7-8x9-10x11
12x13-14x15
16x17-18x19 mm

810 g



M40	127,00	1	024500040
MV40	40,00	1	024510040

M44



141 8-9-10-11-12
13-14-15-16
17-18-19 mm

1,3 kg



M44	321,00	1	024500044
MV44	40,00	1	024510044

M45



142 8-9-10-11-12
13-14-15-16
17-18-19 mm

1,3 kg



M45	366,00	1	024500045
MV45	40,00	1	024510045

M46



142SN 8-9-10-11-12
13-14-15-16
17-18-19 mm

1,4 kg



M46	432,00	1	024500046
MV46	40,00	1	024510046

M49

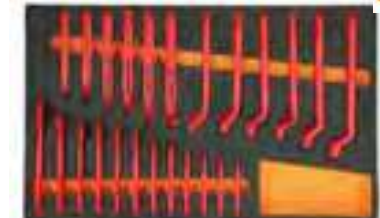

52MQ 7 - 8 - 10 - 11 - 12 - 13 - 14 - 15 - 16 - 17
- 19 - 22 mm
89MQ 7 - 8 - 10 - 11 - 12 - 13 - 14 - 15 - 16 - 17
- 19 - 22 mm

3,3 kg



M49	1.310,00	1	024500049
MV49	77,00	1	024510049

M50



○ 96T 2-2,5-3-4-5
6-7-8 mm

1,1 kg



M50	148,00	1	024500050
MV50	55,00	1	024510051

M52



○96T 2,5-3-4-5-6 mm

330 g



M52	€ 87,50	1	024500052
MV52	€ 40,00	1	024510052

M53



○96TBP 2,5-3-4-5-6 mm

350 g



M53	€ 93,00	1	024500053
MV52	€ 40,00	1	024510052

M55



○97TTX T10-T15-T20-T25-T30

330 g



M55	€ 97,50	1	024500055
MV55	€ 40,00	1	024510055



M60



○96T 2-2,5-3-4-5-6-7-8-10 mm
 ○97BTX/SC8 T9-T10-T15-T20-T25-T27-T30-T40
 ○944BX 5-6-7-8-10-13 mm

1,9 Kg



M60	€ 433,00	1	024500060
MV60	€ 77,00	1	024510060

M62



97TTX T10-T15-T20-T25-T27-T30-T40-T45-T50
 1032 180 mm
 1034 170 mm
 1036 175 mm
 1038 175 mm
 1177BM 140 mm
 1188BM 125 mm
 1257LP 2-2,5-3-3,5 mm
 1257PH 0-00

2,3 kg



M62	€ 522,00	1	024500875
MV62	€ 77,00	1	024510875

M63



○952 7-8-10-12-13-14-17-19 mm

3,4 kg



M63	€ 398,00	1	024500063
MV63	€ 77,00	1	024510063

M65



950 8-10-12-13-14-17-19 mm
 951 2,5-3-4-5-6-8-10-12-14 mm

3,6 Kg



M65	€ 603,00	1	024500065
MV65	€ 77,00	1	024510065

M67



○950 7-8-10-12-13-17 mm

1,8 kg



M67	€ 232,00	1	024500067
MV67	€ 55,00	1	024510067

M69



○951 2,5-3-4-5-6-8-10-12-14 mm

1,8 kg



M69	€ 342,00	1	024500069
MV69	€ 55,00	1	024510069

M75



○933 7-8-9-10-11-12-13-14-15-16-17-18-19-21-22-24 mm

5,5 kg



M75	€ 510,00	1	024500075
MV75	€ 77,00	1	024510075



M78



80 6x7 - 8x9 - 10x11 - 12x13 - 14x15 - 16x17 - 18x19 mm

- 920/36A
- 965 450 mm
- 1052 240 mm
- 1058 175 mm
- 1481PL/A
- 1481PL/B
- 1481PL/C
- 1650 150 mm
- 1708/20
- 1716P

4,4 kg



M78	787,00	1	024500878
MV77	77,00	1	024510876

M79



80 8x9 - 10x11 - 12x13 - 14x15 16x17 - 18x19 mm

1,3 kg



M79	346,00	1	024500079
MV79	40,00	1	024510079

M82



- 920A 10-11-12-13-14 - 15-16-17-18-19 - 20-21-22-23-24 - 26-27-30-32 mm
- 920ME 5-6-8-10-12 mm
- 920AN/125 125 mm
- 920AN/250 250 mm
- 920/25 255 mm
- 920/42 305 mm
- ⊕ 920/55

4,1 kg



M82	497,00	1	024500082
MV82	55,00	1	024510082

M83



- 920A 10-11-12-13-14 - 15-16-17-18-19 - 20-21-22-23-24 - 26-27-30-32 mm
- 920AN/125 125 mm
- 920AN/250 250 mm
- 920/25 255 mm
- 920/42 305 mm
- ⊕ 920/55

3,7 kg



M83	390,00	1	024500083
MV83	55,00	1	024510083

M85



- 851SR 230 mm
- 860LP 0,5x3 - 0,6x4,5 - 0,8x5,5 - 1x5,5 - 1,2x6,5 mm
- 860PE 2 - 2,5 - 3 - 4 - 5 - 6 - 8 - 10 mm
- ⊕ 860PH PH0 - PH1 - PH2 - PH3 - PH4
- ⊕ 860PZ PZ1 - PZ2 - PZ3 - PZ4
- ⊕ 860TX T6 - T7 - T8 - T9 - T10 - T15 - T20 - T25 - T27 - T30 - T40
- ⊕ 860RTX T9 - T10 - T15 - T20 - T25 - T27 - T30 - T40
- 860/55 100 mm
- 882P 80 mm
- 892 ■ 1/4 - □ 1/4

450 g



M85	229,00	1	024500085
MV85	40,00	1	024510085

M86



- 867PE 4-5-6-7-8-10-12 mm
- 867PE/L 4-5-6-7-8-10-12 mm
- 867XZN 5-6-8-10-12 mm
- 867XZN/L 5-6-8-10-12 mm
- ⊕ 867TX T20 - T25 - T30 - T40 - T45 - T50 - T55
- ⊕ 867TX/L T25 - T30 - T40 - T45 - T50 - T55
- ⊕ 867RTX T20 - T25 - T30 - T40 - T45 - T50 - T55
- 867/1
- 867/2

1,4 kg



M86	165,00	1	024500086
MV86	40,00	1	024510086

M91



- 900 4 - 4,5 - 5 - 5,5 - 6 - 7 - 8 - 9 - 10 - 11 - 12 - 13 - 14 mm
- 900ME 2,5-3-4-5-6-8 mm
- 900/20 50 mm
- 900/21 150 mm
- 900/25 □ 1/4 - ■ 1/4
- 900BG/30
- 900/42
- ⊕ 900/55

560 g



M91	267,00	1	024500091
MV90	40,00	1	024510090

M92



- 910A 6-7-8-9-10-11-12-13-14-15-16-17-18-19-20-21-22 mm
- 910/21 125 mm
- 910/22 250 mm
- 910/25
- 910/42
- ⊕ 910/55

1,5 kg



M92	299,00	1	024500092
MV92	40,00	1	024510092

M94



- 900AS/L 3/16 - 7/32 - 1/4 - 9/32 - 5/16 - 11/32 - 3/8 - 7/16 - 1/2 - 9/16
- 900AS 3/16 - 7/32 - 5/32 - 1/4 - 9/32 - 5/16 - 11/32 - 3/8 - 7/16 - 1/2 - 9/16
- 900AN 50-100mm
- 900/25
- ⊕ 900/55
- 900/42

930 g



M94	314,00	1	024500094
MV94	40,00	1	024510094

M96



- 920A/AS 3/8 - 7/16 - 1/2 - 9/16 - 19/32 - 5/8 - 11/16 - 3/4 - 25/32 - 13/16 - 7/8 - 15/16 - 1 - 1.1/16 - 1.1/8 - 1.3/16 - 1.1/4
- 920/25
- 920AN 125-250mm
- 920/42
- ⊕ 920/55

3,8 kg



M96	400,00	1	024500096
MV96	55,00	1	024510096

M100



- 895/1
- 895/3
- 895/6
- 900 4 - 4,5 - 5 - 5,5 - 6 - 7 - 8 - 9 - 10 - 11 - 12 - 13 - 14 mm
- 900L 5 - 6 - 7 - 8 - 9 - 10 - 11 - 12 - 13 mm
- 900ME 3-4-5-6-7 mm
- 900LP 0,8x4 - 1x5,5 - 1,2x6,5 - 1,2x8 mm
- ⊕ 900PH PH1-PH2-PH3-PH4
- ⊕ 900TX T10 - T15 - T20 - T25 - T27 - T30 - T40
- 900/20 50 mm
- 900/20L 100 mm
- 900/21 150 mm
- 900/25
- 900BG/30
- 900/42
- ⊕ 900/55
- 920A 8-10-11-12-13-14-15-16-17-18-19-20-21-22-23-24-26-27-28-30-32 mm
- 920/15
- 920/25 125 mm
- 920AN/125 250 mm
- 920AN/250
- 920/42
- ⊕ 920/55
- ⊕ 920FTX 10 - 12 - 14 - 16 - 18 - 20 - 22 - 24 mm
- 920AL 10 - 12 - 13 - 14 - 15 - 16 - 17 - 18 - 19 - 21 - 22

6,7 Kg

14" 12"



M100	€ 1.365,00	1	024500100
MV100	€ 77,00	1	024510100



M105



- 900 4 - 4,5 - 5 - 5,5 - 6 - 7 - 8 - 9 - 10 - 11 - 12 - 13 - 14 mm
- 900L 5 - 6 - 7 - 8 - 9 - 10 - 11 - 12 - 13 mm
- 96BPC/SC9 1,5 - 2 - 2,5 - 3 - 4 - 5 - 6 - 8 - 10 mm
- 895/1
- 895/3
- 895/6
- 900ME 3-4-5-6-7 mm
- 900LP 0,8x4 - 1x5,5 - 1,2x6,5 - 1,2x8 mm
- ⊕ 900PH PH1-PH2-PH3-PH4
- ⊕ 900TX T10 - T15 - T20 - T25 - T27 - T30 - T40
- 900/16 □ 1/4 - ■ 3/8
- 900/... 50-100-150 mm
- 900/25
- 900BG/30
- 900/42
- ⊕ 900/55
- 910A 6 - 7 - 8 - 9 - 10 - 11 - 12 - 13 - 14 - 15 - 16 - 17 - 18 - 19 - 20 - 21 - 22 mm
- 910/15 □ 3/8 - ■ 1/4
- 910/16 □ 3/8 - ■ 1/2
- 910/21 125 mm
- 910/22 250 mm
- 910/25
- 910/42
- ⊕ 910/55
- 920A 8 - 10 - 11 - 12 - 13 - 14 - 15 - 16 - 17 - 18 - 19 - 20 - 21 - 22 - 23 - 24 - 26 - 27 - 28 - 30 - 32 mm
- 920/15 □ 1/2 - ■ 3/8
- 920/25
- 920AN 125 - 250 mm
- 920/42
- ⊕ 920/55
- 956E 16-17,8-20,8 mm

7,7 kg

14" 38" 12"



M105	€ 1.480,00	1	024500871
MV105	€ 77,00	1	024510871

M108

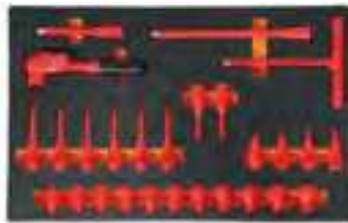

- 910MQ/PE 4-5-6-8 mm
- 910MQ/B 7 - 8 - 10 - 11 - 12 - 13 - 14 - 15 - 16 - 17 - 19 mm
- ⊕ 910MQ/TX T15 - T20 - T25 - T27 - T30 - T40
- 910MQ/XZN 8-10 mm
- 910MQ/21 125 mm
- 910MQ/22 250 mm
- 910MQ/T
- 910MQ/55

2,7 kg



M108	€ 1.425,00	1	024500108
MV108	€ 77,00	1	024510108

M110

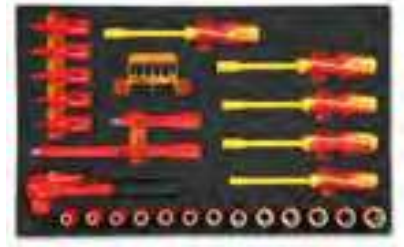

- ⊕ 850MQ
- ⊕ 860TX/A10
- 920MQ/A 8 - 9 - 10 - 11 - 12 - 13 - 14 - 15 - 16 - 17 - 18 - 19 - 20 mm
- 920MQ/PE 5-6-8-10-12 mm
- 920MQ/21 125 mm
- 920MQ/22 250 mm
- 920MQ/55A
- 943MQ 6-7-8-10 mm

3,1 kg



M110	€ 1.440,00	1	024500110
MV110	€ 77,00	1	024510110

M112



- ⊕ 861TX ● 1/4-T6+T15
- ⊕ 866TX ● 5/16-T20+T55
- 895/1 ○ 1/4x□1/4
- 895/6 ○ 5/16x□1/2
- 900FTX □1/4-E4+E10
- 920FTX □1/2-E12+E24
- 920TX □1/2-T55L-T60-T70L

1,3 kg

14" 12"



M112	€ 356,00	1	024500112
MV112	€ 40,00	1	024510112

M115



- ⊕ 666/20 40+200 Nm
- 920A 13 - 14 - 15 - 16 - 17 - 18 - 19 - 20 - 21 - 22 - 24 - 26 - 27 - 30 - 32 mm
- 920FTX 12 - 14 - 16 - 18 - 20 - 22 - 24 mm
- 920PE 6 - 7 - 8 - 8L - 10 - 10L - 12 - 12L - 14 - 14L
- ⊕ 920TX T20 - T25 - T27 - T30 - T40 - T45 - T50 - T55 - T60 - T20L - T25L - T27L - T30L - T40L - T45L - T50L
- 920/21 125 mm
- 920/22 255 mm
- 920/25
- 920/42 305 mm
- ⊕ 920/55

7,8 Kg

12"



M115	€ 1.305,00	1	024500115
MV116	€ 77,00	1	024510116

M120

75



- 920A 10-11-12-13-14-15-16-17-18-19-20-21
22-24-26-27-30-32 mm
- 920AN/125 125 mm
- 920AN/250 250 mm
- 920/25
- 920/42
- 920AL 10 - 12 - 13 - 14 - 15 - 16 - 17 - 18 - 19 -
22 - 24 - 27 - 30 - 32 mm
- 920FTX 10 - 12 - 14 - 16 - 18 - 20 - 22 - 24 mm
- 920/55
- 920PE 5 - 6L - 6 - 6L - 7 - 7L - 8 - 8L - 10 - 10L
- 12 - 12L - 14 - 14L
- 920TX T20-T25-T27-T30-T40-T45-T50-T55-T60
T20L-T25L-T27L-T30L-T40L-T45L-T50L

6,9 Kg

12"



M120	€ 1.455,00	1	024500120
MV120	€ 77,00	1	024510120

M121

46



- 920BP 5L - 6L - 8L - 10L - 5XL - 6XL - 8XL mm
- 920TX T20 - T25 - T27 - T30 - T40L - T45L
- T50L - T55L - T60L - T70L
- 920XZN 4 - 5 - 6 - 6L - 8 - 8L - 10 - 10L - 12 - 12L
- 14 - 14L - 16 - 18 mm
- 920ES 7 - 9 - 10 - 11 - 12L - 14L - 16L - 7XL -
9XL - 10XL - 11XL - 12XL - 14XL - 16XL
mm
- 920/36A

6,3 Kg

12"



M121	€ 1.375,00	1	024500121
MV121	€ 77,00	1	024510121

M125

68



- 910AL 8 - 9 - 10 - 11 - 12 - 13 - 14 - 15 - 16 - 17
- 19 - 21 - 22 mm
- 920PE 5-6-6L-7-8-8L-10-10L-12-12L mm
- 920FTX E12 - E14 - E16 - E18 - E20 - E22 - E24
- 920TX T20 - T25 - T27 - T30 - T30L - T40 - T40L
- T45 - T50 - T50L - T55 - T60 - T60L
- 920XZN 5 - 6 - 6L - 8 - 8L - 10 - 10L - 12L mm
- 920AL 10 - 12 - 13 - 14 - 15 - 16 - 17 - 18 - 19
- 21 - 22 - 23 - 24 - 27 - 30 - 32 mm
- 1692/5 5 m

7,9 kg

38" 12"



M125	€ 1.435,00	1	024500872
MV125	€ 77,00	1	024510872

M126

26



- 928A 19 - 21 - 22 - 24 - 26 - 27 - 28 - 30 - 32
- 34 - 35 - 36 - 38 - 41 - 46 mm
- 928ME 14-17-19-22 mm
- 928/15 □ 3/4 - ■ 1/2
- 928/16 □ 3/4 - ■ 1
- 928/21 200 mm
- 928/22 380 mm
- 928/25 450 mm
- 928/42 450 mm
- 928/55

12,4 kg

34"



M126	€ 1.089,00	1	024500126
MV126	€ 77,00	1	024510126

M127

23



- 728 19 - 21 - 22 - 24 - 27 - 30 - 32 - 33 - 34
- 35 - 36 - 38 - 40 - 41 - 46
- 728FTX 20-22-24 mm
- 728/15 □ 3/4 - ■ 1/2
- 728/16 □ 3/4 - ■ 1
- 728/21 175 mm
- 728/22 250 mm
- 728/25

12,5 kg

34"



M127	€ 1.050,00	1	024500127
MV127	€ 77,00	1	024510127

M128

50



- 720 10 - 11 - 12 - 13 - 14 - 15 - 16 - 17 - 18
- 19 - 21 - 22 - 24 - 27 - 30 - 32 mm
- 720L 10 - 11 - 12 - 13 - 14 - 15 - 16 - 17 - 18
- 19 - 21 - 22 - 24 - 27 - 30 - 32 mm
- 720TX T30-T40-T45-T50-T55
- 720ME 5 - 6 - 8 - 10 - 12 - 14 - 17 - 19 mm
- 720LC 17-19-21 mm
- 720/21 125 mm
- 720/25

8,9 kg

12"



M128	€ 1.067,00	1	024500128
MV128	€ 77,00	1	024510128

M129

13



- 1032 180 mm
- 1034 170 mm
- 1036 175 mm
- 1038 175 mm
- 1048N 250 mm
- 1052 240 mm
- 1082BM 160 mm
- 1098 220 mm
- 1112 250 mm
- 1128BM
- 1150BM 180 mm
- 1166BM 160 mm
- 1168BM 160 mm

3,4 Kg



M129	€ 518,00	1	024500129
MV138	€ 77,00	1	024510138

M133

3



- 1082G 160 mm
- 1150G 180 mm
- 1166G 160 mm

650 g



M133	€ 96,50	1	024500133
MV133	€ 40,00	1	024510133

M134

3

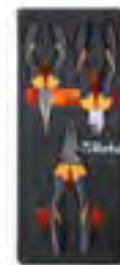

- 1082GBM 160 mm
- 1150GBM 180 mm
- 1166GBM 160 mm

750 g



M134	€ 124,00	1	024500134
MV134	€ 40,00	1	024510134

M135



- 1082MQ 160 mm
- 1150MQ 180 mm
- 1166MQ 160 mm

750 g



M135	€ 206,00	1	024500135
MV135	€ 40,00	1	024510135

M136



- 1084BM 160 mm
- 1150BM 180 mm
- 1166BM 160 mm

750 g



M136	€ 140,00	1	024500136
MV131	€ 40,00	1	024510131

M137



- 1084 160 mm
- 1150 180 mm
- 1166 160 mm

650 g



M137	€ 114,00	1	024500137
MV132	€ 40,00	1	024510132

M145



- 1032 180 mm
- 1034 170 mm
- 1036 175 mm
- 1038 175 mm

640 g



M145	€ 154,00	1	024500145
MV145	€ 40,00	1	024510145

M153



- 1048N 250 mm
- 1052 240 mm

1 kg



M153	€ 112,00	1	024500153
MV154	€ 40,00	1	024510154

M161



- 1128MQ
- 1048MQ 250 mm
- 1082MQ 160 mm
- 1150MQ 180 mm
- 1162MQ 160 mm
- 1164MQ 160 mm
- 1272MQ PH0x60 - PH1x80 - PH2x100 - PH3x150 mm
- 1274MQ 2,5x75 - 3x100 - 4x100 - 5,5x125 mm
- 1777MQ/U

3,0 kg



M161	€ 609,00	1	024500161
MV161	€ 77,00	1	024510161

M162



- 1241 5,5x100 - 6,5x125 - 8x150 - 10x200 mm
- 1242 PH1x100 - PH2x100 - PH3x150 - PH4x200 mm

1,4 kg



M162	€ 169,00	1	024500162
MV162	€ 55,00	1	024510162



M166



860MIX/A31

- 1048N 250 mm
- 1082BM 160 mm
- 1150BM 180 mm
- 1162BM 160 mm
- 1290 3x75 - 4x100 - 5,5x100 - 6,5x150 - 8x150 mm
- 1290N 6,5x30 mm
- 1292 4,5x80 - 6x100 - 8x150 mm
- 1292N 6x30 mm
- 1297TX T20-T25-T27-T30

2,9 kg



M166	€ 532,00	1	024500879
MV880	€ 77,00	1	024510880

M170



- 1290 2,5x50 - 3x75 - 3,5x100 - 4x125 - 5,5x100 - 5,5x150 - 6,5x150 mm

500 g



M170	€ 92,00	1	024500170
MV170	€ 40,00	1	024510170

M172



- 1292 PH0x60 - PH0x100 - PH1x80 - PH1x120 - PH2x100 - PH2x150 mm

450 g



M172	€ 83,50	1	024500172
MV172	€ 40,00	1	024510172



M174



6

1297TX T8 - T10 - T15 - T20
- T25 - T30

450 g



M174	122,00	1	024500174
MV174	40,00	1	024510174

M180



7

1290 3x75
4x100
5,5x150
6,5x150 mm
1292 PH0x60
PH1x80
PH2x100 mm

500 g



M180	95,00	1	024500180
MV180	40,00	1	024510180

M195



25

1260 2,5x50 - 3x75 - 4x100 - 5,5x125 - 6,5x150
- 8x200 mm
1260N 4x30 mm
1262 PH0x60 - PH1x80 - PH2x100 - PH3x150
mm
1262N PH1x30 mm
1267TX T6 - T7 - T8 - T9 - T10 - T15 - T20 - T25
- T27 - T30 - T40 - T45
1253 3,5x100 mm

2,3 kg



M195	368,00	1	024500195
MV195	77,00	1	024510195

M201



6

1260 3x75 - 4x100 -
6,5x150 mm
1262 PH0x60 - PH1x80 -
PH2x100 mm

500 g



M201	94,50	1	024500201
MV201	40,00	1	024510201

M204



6

1267TX T8 - T10 - T15 - T20
- T25 - T30

450 g



M204	92,50	1	024500204
MV204	40,00	1	024510204

M208



10

1260 3x75
3,5x100
4x125
5,5x150
6,5x150 mm
1262 PH0x60
PH1x80
PH2x100 mm
4x30 mm
1260N
1262N PH1x30 mm

750 g



M208	107,00	1	024500208
MV208	55,00	1	024510208

M209



10

1260N 4x30 mm
1264 2,5x60 - 3x100 -
4x125 - 5x150 -
6,5x150 mm
1262 PH0x60 - PH1x80 -
PH2x100 mm
1262N PH1x30 mm

820 g



M209	106,00	1	024500209
MV208	55,00	1	024510208

M213



25

1201E 2,5x50 - 3x75 - 4x100 - 5,5x125 - 6,5x150
- 8x200 mm
1201EN 4x30 mm
1202E PH0x60 - PH1x80 - PH2x100 - PH3x150
mm
1202EN PH1x30 mm
1207E/TX T6 - T7 - T8 - T9 - T10 - T15 - T20 - T25
- T27 - T30 - T40 - T45
1253 3,5x100 mm

1,8 Kg



M213	249,00	1	024500213
MV210	77,00	1	024510210

M214



7

1201E 2,5x50 - 3x75 -
3,5x100
- 4x125 - 5,5x100 -
5,5x150 - 6,5x150 mm

500 g



M214	51,50	1	024500214
MV211	40,00	1	024510211

M216



6

1202E PH0x60 - PH1x80
- PH1x120 - PH2x100
- PH2x150 - PH3x150
mm

450 g



M216	56,00	1	024500216
MV212	40,00	1	024510212

M217



7

1207E/TX T6 - T7 - T8 - T9 - T10
- T15 - T20

500 g



M217	71,50	1	024500217
MV215	40,00	1	024510215



M218



- 1201E 3x75
4x100
5,5x150
6,5x150 mm
- ⊕ 1202E PH0x60
PH1x80
PH2x100 mm

500 g



M218	€ 54,00	1	024500218
MV220	€ 40,00	1	024510220

M219



- ⊕ 1202E 3x60 - 4,5x80 - 6x100 mm
- 1204E 3x75 - 4x100 - 5x150 - 6,5x150 mm

590 g



M219	€ 54,50	1	024500219
MV220	€ 40,00	1	024510220

M222



- ⊕ 1272MQ PH0x60 mm
- ⊕ 1272MQF PH1x80 - PH2x100 mm
- 1274MQF 3,5x100 - 4,5x100 - 5,5x125 - 6,5x150 mm

540 g



M222	€ 156,00	1	024500222
MV222	€ 40,00	1	024510222

M226



- 1274MQ 3x100
4x100
5,5x125
6,5x150 mm
- ⊕ 1272MQ PH0x60
PH1x80
PH2x100 mm

500 g



M226	€ 119,00	1	024500226
MV226	€ 40,00	1	024510226

M227



- 944BX 6-7-8-10-13 mm

420 g



M227	€ 145,00	1	024500227
MV227	€ 40,00	1	024510227

M230



- 30 Ø 2-3-4 mm
- 31 Ø 2-3-4-5-6-8 mm
- 32 Ø 4 mm
- 34 150 mm
- 35 200-250 mm
- 36 125 mm
- 1370 500 g
- 1390 Ø 35 mm
- 1692 3 m
- 1712TF
- 1719BMA/Q 200 mm
- ▲ 1719BMA/T 200 mm
- 1719BMA/P 200 mm
- ▶ 1719BMA/M 200 mm
- 1719BMA/R 200 mm
- 1737NX
- 1771 18 mm

3,2 Kg



M230	€ 475,00	1	024500230
MV230	€ 77,00	1	024510230



M231



- 31 2-3-4-5-6-8 mm
- 32 4 mm
- 34 125-150-175 mm
- 36 125 mm
- 1370 500-1000 g
- 1390 Ø 35 mm
- 1712TF 590 mm
- 1715 670 mm
- 1719BMA8/Q 200 mm
- ▲ 1719BMA8/T 200 mm
- 1719BMA8/P 200 mm
- ▶ 1719BMA8/M 200 mm
- 1719BMA8/R 200 mm
- 1737NX

4,7 kg



M231	€ 458,00	1	024500877
MV231	€ 77,00	1	024510877

M234



- 35 100-200 mm
- 1370 300 g
- 1390 Ø 35 mm

1,3 kg



M234	€ 120,00	1	024500234
MV232	€ 40,00	1	024510232

M236



- 1719BMA/Q 200 mm
- ▲ 1719BMA/T 200 mm
- 1719BMA/P 200 mm
- ▶ 1719BMA/M 200 mm
- 1719BMA/R 200 mm

870 g



M236	€ 119,00	1	024500236
MV236	€ 40,00	1	024510236

M237



35 100-200 mm
1370T 300 mm
1390N Ø 35 mm

1,3 kg



M237	131,00	1	024500237
MV232	40,00	1	024510232

M240



31BM Ø 2-3-4-5-6-8 mm
32 Ø 4 mm

850 g



M240	158,00	1	024500240
MV240	40,00	1	024510240

M264



1491 Ø 65+110 mm
■ 1494 ■ 10 mm
○ 1494E ○ 8 - 9 - 10 - 11 - 12 - 14 - 17 mm
○ 1494Q ○ 8-9,5-12-13 mm
△ 1494T △ 9,5
○ 1494XZN ○ 16
1496C ■ 8x ■ 10 mm

2,1 kg



M264	277,00	1	024500264
MV264	40,00	1	024510264

Beta

M284



1128BMX
1130BMX
■ 1719BMA...Q 200 mm
▲ 1719BMA...P 200 mm
▶ 1719BMA...M 200 mm
● 1719BMA...R 200 mm
1726BM 400 mm
1728BM (5)
1771BM 170 mm
1778V18 185 mm

2,4 Kg



M284	280,00	1	024500284
MV284	77,00	1	024510284

M292



111E 250 mm
1128BMX
1692/5 5 m
1771 170 mm

500 g



M292	134,00	1	024500292
MV293	40,00	1	024510293

M294



1692/5 5 m
1725CR 260 mm
1771 18 mm
1771RL

500 g



M294	91,00	1	024500294
MV294	40,00	1	024510294

M295



1650
1682 L=300 mm
1707
1708/20

450 g



M295	136,00	1	024500295
MV295	40,00	1	024510295

M305



1927B
○ 720 12-13-14-15-16-17
18-19-21-22
24-27 mm
720/21

4,2 kg



M305	470,00	1	024500305
MV305	55,00	1	024510305

M310



1927CD
○ 720 12-13-14-15-16-17
18-19-21-22
24-27 mm
720/21

4,0 kg



M310	706,00	1	024500310
MV310	55,00	1	024510310

Beta

Beta

M400



- 3932U
- 3935 120 mm
- 3937 170 mm
- 3952 13 - 14 - 15 - 16 - 17 - 18 - 19 mm
- 3961 3,2
- 3961 3,3
- 3961 3,5
- 3961U 3,2 - 4,0 mm
- 3969 200 mm (x2)
- 3969K3 113 mm
- 3973/1
- 3973/2
- 3973/3
- 3973/4
- 3984/1 Ø35 mm
- 3984/2 Ø22,8 mm
- 3984/3 Ø23,5 mm
- 3984/4 Ø23 mm
- 3991 222 mm
- 3992 234 mm

3,1 kg



	€	1	024500400
M400	706,00	1	024500400
MV400	77,00	1	024510400

M401



- 3921 440 mm
- 3948
- 3953
- 3955 30x32 - 32x36 mm
- 3967 289 mm
- 3971

2,7 kg



	€	1	024500401
M401	427,00	1	024500401
MV401	77,00	1	024510401

RSC22 RSC23 RSC23C C27S			543 559
C41S C41H			543

MC10



- 42 6-7-8-9-10-11-12
13-14-15-16-17
18-19-21-22 mm
- 96/SC9 1,5 - 2 - 2,5 - 3 - 4 - 5 - 6 - 8 - 10 mm
- ◡ 1084BM 160 mm
- ≡ 1150G 180 mm
- 1166G 160 mm
- 1201E 3,5x100 - 5,5x150 - 6,5x150 mm
- ⊕ 1202E PH0x60 - PH1x80 - PH2x100 mm

3,5 kg



	€	1	027500011
MC10	444,00	1	027500011
MCV10	55,00	1	027510010

MC12



- 42 6 - 7 - 8 - 9 - 10 - 11 - 12 - 13 - 14 - 15 - 16 - 17
- 18 - 19 - 21 - 22 mm
- 96/SC9 1,5 - 2 - 2,5 - 3 - 4 - 5 - 6 - 8 - 10 mm
- 1692/5 5 m

2,2 kg



	€	1	041500012
MC12	292,00	1	041500012
MCV11	55,00	1	041510011

MC20



- 860MIX/A31
- 895/1
- 1048N 250 mm
- 1370 300 g
- 32 Ø 4 mm
- 36 Ø 4 mm
- 900 4 - 4,5 - 5 - 5,5 - 6 - 7 - 8 - 9 - 10 - 11 - 12 - 13 - 14 mm
- 900/21 150 mm
- 900/25
- 900BG/30C
- 900/42
- 900/55
- 920A 10 - 11 - 12 - 13 - 14 - 15 - 16 - 17 - 18 - 19 - 21 - 22 - 24
- 27 - 30 - 32 mm

- 920/25
- 920AN/125 125 mm
- 920/42
- 920/55

6 kg



	€	1	027500020
MC20	692,00	1	027500020
MCV20	55,00	1	027510021

MC21



- 920A 10 - 11 - 12 - 13 - 14 - 15 - 16 - 17 - 18 - 19 - 20
- 21 - 22 - 23 - 24 - 26 - 27 - 30 - 32 mm
- 920/25
- 920/42
- ⊕ 920/55
- 920AN 125-250 mm

4,3 kg



	€	1	041500021
MC21	390,00	1	041500021
MCV21	55,00	1	041510021



C35

447 mm
1
600 mm

544÷546



MB12



- 42 6-7-8-9-10-11-12-13-14-15-16-17-18-19-20-21-22-24-27-30-32 mm
- 55 6x7-8x9-10x11-12x13-14x15-16x17-18x19-20x22 mm
- 1048N 250 mm

MB12	€ 673,00	1	024504212
MBV13	€ 211,00	1	024524213

MB37



- 920A 10-11-12-13-14-15-16-17-18-19-20-21-22-23-24-26-27-30-32 mm
- 920/21 125 mm
- 920/22 150 mm
- 920/25 250 mm
- 920/42 240 mm
- 920/55 160 mm
- 111E 180 mm
- 1052 160 mm
- 1084BM 160 mm
- 1150BM 180 mm
- 1166BM 160 mm
- 1032 180 mm
- 1034 170 mm
- 1036 175 mm
- 1038 175 mm
- 900 4-4,5-5-5,5-6-7-8-9-10-11-12-13-14 mm
- 900/20 50 mm
- 900/21 150 mm
- 900/25 900BG/30
- 900/55 900/42

MB37	€ 1.045,00	1	024504237
MBV40	€ 211,00	1	024524240

MB38



- 96T 2-2,5-3-4-5-6-7-8 mm
- 851SR 230 mm
- 860LP 0,5x3-0,6x4,5-0,8x5,5-1x5,5-1,2x6,5 mm
- 860PE 2-2,5-3-4-5-6-8-10 mm
- 860PH PH0 - PH1 - PH2 - PH3 - PH4
- 860PZ PZ1 - PZ2 - PZ3 - PZ4
- 860RTX T9 - T10 - T15 - T20 - T25 - T27 - T30 - T40
- 860TX T6 - T7 - T8 - T9 - T10 - T15 - T20 - T25 - T27 - T30 - T40
- 860/55 100 mm
- 882P 100 mm
- 892/0 100 mm
- 920A 10-11-12-13-14-15-16-17-18-19-20-21-22-23-24-26-27-30-32 mm
- 920/21 125 mm
- 920/22 255 mm
- 920/25 125 mm
- 920/42 255 mm
- 920/55 160 mm
- 1084BM 160 mm
- 1150BM 180 mm
- 1166BM 160 mm

MB38	€ 904,00	1	024504238
MBV35	€ 211,00	1	024524235



MB39



- 920A 10-11-12-13-14-15-16-17-18-19-20-21-22-23-24-26-27-30-32 mm
- 920/21 125 mm
- 920/22 255 mm
- 920/25 125 mm
- 920/42 255 mm
- 920/55 5-6-8-10-12 mm
- 920PE 180 mm
- 1032 170 mm
- 1034 170 mm
- 1036 175 mm
- 1038 175 mm
- 35 200 mm
- 1084BM 160 mm
- 1150BM 180 mm
- 1166BM 160 mm
- 1370 500 g
- 1390 35 mm

MB39	€ 877,00	1	024504239
MBV36	€ 211,00	1	024524236

MB44

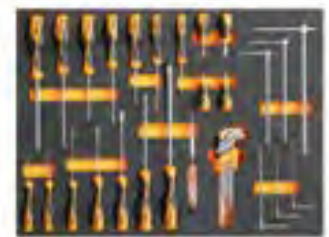

- 1260 2,5x50 - 3x75 - 3,5x100 - 4x100 - 5,5x125 - 6,5x150 - 8x200 mm
- 1260N 4x30-6,5x30 mm
- 1262 PH0x60 - PH0x100 - PH1x80 - PH1x120 - PH2x100 - PH2x150 - PH3x150 mm
- 1262N PH1x30-PH2x30 mm
- 1253 96BPC/SC9 2,5-3-4-5-6-8 mm

MB44	€ 450,00	1	024504244
MBV44	€ 211,00	1	024524244

MB45



- 1260 2,5x50 - 3x75 - 3,5x100 - 4x100 - 5,5x100 - 5x125 - 6,5x150 mm
- ⊕ 1262 PH0x60 - PH0x100 - PH1x80 - PH1x120 - PH2x100 - PH2x150 mm
- ⊗ 1267TX T8 - T10 - T15 - T20 - T25 - T30
- 1052 240 mm
- 96BPC/SC9

2,8 kg



MB45	€ 334,00	1	024504245
MBV45	€ 211,00	1	024524245

MB46



- 1260 3x75 - 4x100 - 5,5x125 - 6,5x150 mm
- ⊕ 1262 PH0x60 - PH1x80 - - - PH2x100 mm
- ⊗ 1267TX T8 - T10 - T15 - T20 - T25 - T30
- 96BPC/SC9
- 96T 2-2,5-3-4-5-6
- 1052 240 mm

2,8 kg



MB46	€ 374,00	1	024504246
MBV46	€ 211,00	1	024524246

MB47



- 1260 3x75 - 4x100 - 5,5x125 - 6,5x150 mm
- ⊕ 1262 PH0x60 - PH1x80 - - - PH2x100 mm
- 1260N 4x30 mm
- ⊕ 1262N PH1x30 mm
- 96T 2,5-3-4-5-6-8 mm
- 96BPC/SC9
- 920A 10 - 11 - 12 - 13 - 14 - 15 - 16 - 17 - 18 - 19 - 20 - 21 - 22 - 23 - 24 - 26 - 27 - 30 - 32 mm
- 920/21 125 mm
- 920/22 250 mm
- 920/25
- 920/42
- ⊗ 920/55

5,6 kg



MB47	€ 715,00	1	024504247
MBV47	€ 211,00	1	024524247

MB56

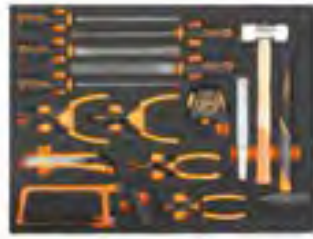

- 1719BMA/Q 200 mm
- ▲ 1719BMA/T 200 mm
- 1719BMA/P 200 mm
- ▶ 1719BMA/M 200 mm
- 1719BMA/R 200 mm
- 1032 180 mm
- 1034 170 mm
- 1036 175 mm
- 1038 175 mm
- 1370T 300 g
- 1390N Ø 35 mm
- 35 200 mm
- 1692 5 mt
- 1725CR 260 mm
- 1771 18 mm

3,7 kg



MB56	€ 429,00	1	024504256
MBV56	€ 211,00	1	024524256

MB58



- 31 Ø 2-3-4-5-6 mm
- 32 Ø 4 mm
- 35 200 mm
- 1112 250 mm
- 1128BMX
- 1370 500 g
- 1390 Ø 45 mm
- 1719BMA...Q 200 mm
- ▲ 1719BMA...T 200 mm
- 1719BMA...P 200 mm
- ▶ 1719BMA...M 200 mm
- 1719BMA...R 200 mm
- 1726 440 mm

4,5 kg



MB58	€ 429,00	1	024504258
MBV55	€ 211,00	1	024524255



MB59



- 1719BMA...Q 200 mm
- ▲ 1719BMA...T 200 mm
- 1719BMA...P 200 mm
- ▶ 1719BMA...M 200 mm
- 1719BMA...R 200 mm
- 31 Ø 4-6 mm
- 32 Ø 4 mm
- 35 125-200 mm
- 1370 300 g
- 1390 Ø 35 mm
- 1692 5 mt
- 1725 420 mm
- 1833XS/2

3,4 kg



MB59	€ 360,00	1	024504259
MBV57	€ 211,00	1	024524257

MB65

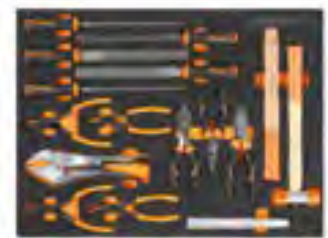

- 1719BMA...Q 200 mm
- 1719BMA...P 200 mm
- 1719BMA...T 200 mm
- 1719BMA...M 200 mm
- 1719BMA...R 200 mm
- 35 200 mm
- 1032 180 mm
- 1034 170 mm
- 1036 175 mm
- 1038 175 mm
- 1052 240 mm
- 1084BM 160 mm
- 1150BM 180 mm
- 1166BM 160 mm
- 1370 500 g
- 1390 Ø 35 mm

4,8 kg



MB65	€ 555,00	1	024504265
MBV61	€ 211,00	1	024524261



MB63

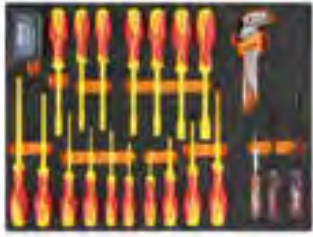

- 96BPC/SC9
- 1250 4x125 mm
- ⊕ 1251 PH1x125 mm
- 1253
- 943MQ 5,5-6-7-8-10-13 mm
- ⊕ 1272MQ PH0x60 - PH1x80 - PH2x100 - PH3x150 mm
- 1274MQ 2,5x75 - 3x100 - 4x100 - 5,5x125 - 6,5x150 - 8x175 mm
- 860LP 0,5x3 - 0,6x4 - 0,8x5,5 - 1,0x5,5 - 1,2x6,5 mm
- 860PE 2 - 2,5 - 3 - 4 - 5 - 6 - 8 - 10 mm
- ⊕ 860PH PH0 - PH1 - PH2 - PH3 - PH4
- ⊕ 860PZ PZ1 - PZ2 - PZ3 - PZ4
- ⊕ 860RTX T9 - T10 - T15 - T20 - T25 - T27 - T30 - T40
- 882MSR 50 ○ 1/4 ● 1/4
- 850MQ

3,2 kg



MB63	575,00	1	024504263
MBV63	211,00	1	024524263

MB64



- 55 6x7-8x9-10x11 - 12x13-14x15 - 16x17-18x19 - 20x22 mm
- 1048MQ 250 mm
- 1082MQ 140 mm
- 1128BSX
- 1132MQ 230 mm
- 1142MQ 160 mm
- 1150MQ 180 mm
- 1166MQ 160 mm
- 1168MQ 160 mm
- 110MQ 250 mm
- 1777MQ
- 993MQ
- 1602

4,1 kg



MB64	1.028,00	1	024504264
MBV62	211,00	1	024524262

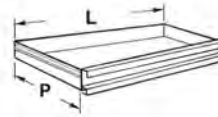

C45PRO

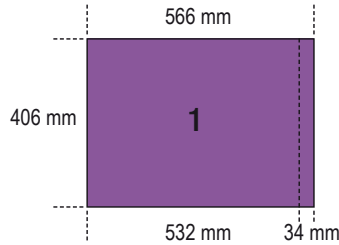

546



MM11



- 42 6 - 7 - 8 - 9 - 10 - 11 - 12 - 13 - 14 - 15 - 16 - 17 - 18 - 19 - 20 - 21 - 22 - 24 - 27 - 30 - 32 mm
- 96BPC/SC9 1,5 - 2 - 2,5 - 3 - 4 - 5 - 6 - 8 - 10 mm

4,5 kg



MM11	459,00	1	024580011
MMV10	77,00	1	024590010

MM26



- 42 6 - 7 - 8 - 9 - 10 - 11 - 12 - 13 - 14 - 15 - 16 - 17 - 18 - 19 - 21 - 22 - 24 - 27 mm
- 250 mm
- 111E
- 123Q1/4
- 123Q3/8
- 123Q1/2
- 142 8 - 9 - 10 - 11 - 12 - 13 - 14 - 15 - 16 - 17 - 18 - 19 mm

4,3 kg



MM26	740,00	1	024580026
MMV26	77,00	1	024590026



MM30

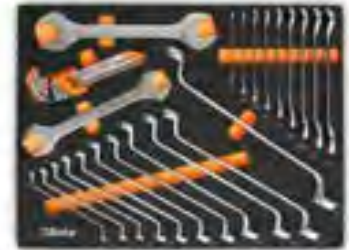

- 55 6x7-8x9-10x11-12x13-14x15-16x17 - 18x19-20x22-21x23-24x27-30x32 mm
- 90 6x7-8x9-10x11-12x13-14x15-16x17 - 18x19-20x22-21x23-24x27-30x32 mm
- 96BPC/SC9 1,5 - 2 - 2,5 - 3 - 4 - 5 - 6 - 8 - 10 mm

4,9 kg



MM30	485,00	1	024580030
MMV30	77,00	1	024590030

MM60



- 96T 2 - 2,5 - 3 - 4 - 5 - 6 - 7 - 8 - 10 mm
- 97BTX/SC8 T9-T10-T15-T20-T25-T27-T30-T40
- 944BX 5-6-7-8-10-13 mm

2,2 Kg



MM60	462,00	1	024580060
MMV60	77,00	1	024590060

MM63



- 952 7 - 8 - 10 - 12 - 13 - 14 - 17 - 19 mm

3,4 kg



MM63	427,00	1	024580063
MMV63	77,00	1	024590063

MM100

98



- 895/1
- 895/3
- 895/6
- 900 4 - 4,5 - 5 - 5,5 - 6 - 7 - 8 - 9 - 10 - 11 - 12 - 13 - 14 mm
- 900L 5 - 6 - 7 - 8 - 9 - 10 - 11 - 12 - 13 mm
- 900ME 3-4-5-6-7 mm
- 900LP 0,8x4 - 1x5,5 - 1,2x6,5 - 1,2x8 mm
- ⊕ 900PH PH1-PH2-PH3-PH4
- ⊕ 900TX T10 - T15 - T20 - T25 - T27 - T30 - T40
- 900/20 50 mm
- 900/20L 100 mm
- 900/21 150 mm
- 900/25
- 900BG/30
- 900/42
- ⊕ 900/55
- 920A 8-10-11-12-13-14-15-16-17-18-19-20-21-22-23-24-26-27-28-30-32 mm
- 920/15
- 920/25
- 920AN/125 125 mm
- 920AN/250 250 mm
- 920/42
- ⊕ 920/55
- 920/42 10 - 12 - 14 - 16 - 18 - 20 - 22 - 24 mm
- 920AL 10 - 12 - 13 - 14 - 15 - 16 - 17 - 18 - 19 - 21 - 22

6,7 Kg



MM100	€ 1.365,00	1 024580100
MMV100	€ 77,00	1 024590100



MM129

12



- 1032 180 mm
- 1034 170 mm
- 1036 175 mm
- 1038 175 mm
- 1048N 250 mm
- 1052 240 mm
- ⊕ 1082BM 160 mm
- 1098 220 mm
- 1128BM
- ≡ 1150BM 180 mm
- 1166BM 160 mm

2,9 Kg



MM129	€ 482,00	1 024580129
MMV129	€ 77,00	1 024590129



MM210

25



- 1201E 2,5x50 - 3x75 - 4x100 - 5,5x125 - 6,5x150 - 8x200 mm
- 1201EN 4x30 mm
- ⊕ 1202E PH0x60 - PH1x80 - PH2x100 - PH3x150 mm
- ⊕ 1202EN PH1X30 mm
- ⊕ 1207E/TX T6 - T7 - T8 - T9 - T10 - T15 - T20 - T25 - T27 - T30 - T40 - T45
- 1253

2,1 kg



MM210	€ 249,00	1 024580211
MMV210	€ 77,00	1 024590210

MM105

107



- 895/1 ○1/4-□1/4
- 895/3 ○1/4-□3/8
- 895/6 ○5/16-□1/2
- 900 4 - 4,5 - 5 - 5,5 - 6 - 7 - 8 - 9 - 10 - 11 - 12 - 13 - 14 mm
- 900L 5 - 6 - 7 - 8 - 9 - 10 - 11 - 12 - 13 mm
- 900ME 3-4-5-6-7 mm
- 900LP 0,8x4 - 1x5,5 - 1,2x6,5 - 1,2x8
- ⊕ 900PH PH1-PH2-PH3-PH4
- ⊕ 900TX T10 - T15 - T20 - T25 - T27 - T30 - T40
- 900/16
- 900/... 50-100-150 mm
- 900/25
- 900BG/30 176 mm
- 900/42 115 mm
- ⊕ 900/55 125 mm
- 910A 6 - 7 - 8 - 9 - 10 - 11 - 12 - 13 - 14 - 15 - 16 - 17 - 18 - 19 - 20 - 21 - 22 mm
- 910/15 □3/8-■1/4
- 910/16 □3/8-■1/2
- 910/21 125 mm
- 910/22 250 mm
- 910/25
- 910/42 210 mm
- ⊕ 910/55 200 mm
- 920A 8 - 10 - 11 - 12 - 13 - 14 - 15 - 16 - 17 - 18 - 19 - 20 - 21 - 22 - 23 - 24 - 26 - 27 - 28 - 30 - 32 mm
- 920/15 □1/2-■3/8
- 920/25
- 920AN 125-250 mm
- 920/42 305 mm
- ⊕ 920/55 275 mm
- 956E 16 mm (5/8") - 17,8 (11/16") - 20,8 (13/16")

7,2 kg

14" 38" 12"



MM105	€ 1.430,00	1 024580105
MMV105	€ 77,00	1 024590105

MM230

25



30	Ø 2-3-4 mm
31	Ø 2-3-4-5-6-8 mm
32	Ø 4 mm
34	150 mm
35	200-250 mm
36	125 mm
1370	500 g
1390	Ø 35 mm
1692	3 m
1712TF	
1719BMA...Q	200 mm
1719BMA...T	200 mm
1719BMA...P	200 mm
1719BMA...M	200 mm
1719BMA...R	200 mm
1737NX	
1771	

3,2 Kg



MM230	499,00	1	024580230
MMV230	77,00	1	024590230

MM400

29



3932U	
3935	120 mm
3937	170 mm
3952	13 - 14 - 15 - 16 - 17 - 18 - 19 mm
<input type="checkbox"/> 3961 3,2	
<input type="checkbox"/> 3961 3,3	
<input type="checkbox"/> 3961 3,5	
<input type="checkbox"/> 3961U	3,2 - 4,0 mm
3969	200 mm (x2)
3969K3	113 mm
3973/1	
3973/2	
3973/3	
3973/4	
3984/1	
3984/2	
3984/3	
3984/4	
3991	222 mm
3992	234 mm

3,1 kg



MM400	706,00	1	024580400
MMV400	77,00	1	024590400

MM401

7



3921	440 mm
3948	
3953	
3955	30x32 mm - 32x36 mm
3967	289 mm
3971	

2,7 kg



MM401	427,00	1	024580401
MMV401	77,00	1	024590401

VPM0

Schaumeinsatz

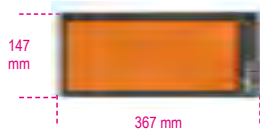

VPM0	31,50	1	088870350
------	-------	---	-----------

VPM3

Schaumeinsatz mit 4 Behälter

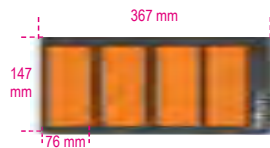

VPM3	31,50	1	088870353
------	-------	---	-----------

VPM7

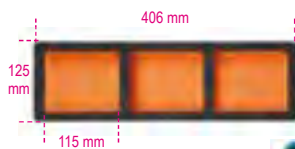

VPM7	33,50	1	088870356
------	-------	---	-----------

VPM8



VPM8	26,00	1	088870357
------	-------	---	-----------

VPM9



VPM9	25,00	1	088870358
------	-------	---	-----------

VPM7-C

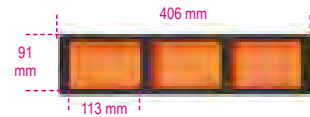

VPM7C	39,00	1	088870360
-------	-------	---	-----------



Feste Thermoformateinsätze der Serie T



Werkzeugsortimente in Thermoformateinsätzen für Werkzeugwagen und Werkzeugkasten.

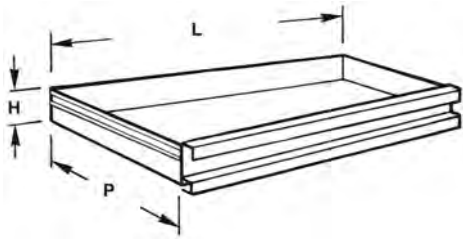

H mm	LxP mm
70	588x367

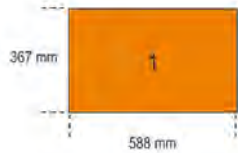
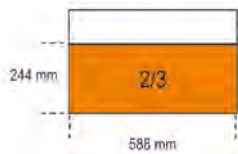
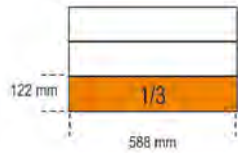
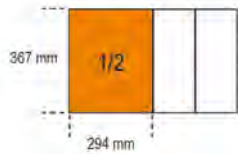
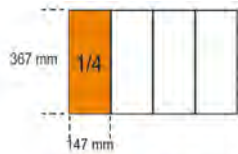

T01



42 6-7-8-10-11-12-13
14-16-17-18-19-21
22-24-27-30 mm

2,7 kg



	€	1	024240001
T01	300,00	1	024240001
TV10	39,50	1	024000400

T05



42 6-7-8-9-10-11-12
13-14-15-16-17
18-19-20-21 mm

1,5 kg



	€	1	024240005
T05	231,00	1	024240005
TV15	30,00	1	024000445

T06



42 22-24-27-30-32 mm

2,1 kg



	€	1	024240006
T06	162,50	1	024240006
TV16	30,00	1	024000446

T18



42MP 6-7-8-9-10-11-12
13-14-15-16-17
18-19-20-21 mm

1,5 kg



	€	1	024240018
T18	334,00	1	024240018
TV15	30,00	1	024000445

T19



42MP 22-24-27-30-32 mm

2,1 kg



	€	1	024240019
T19	220,00	1	024240019
TV16	30,00	1	024000446

T22



42AS 5/16-3/8-7/16-1/2
9/16-5/8-11/16-3/4
Ø96AS/BG7 3/32-1/8-5/32-3/16
1/4-5/16-3/8

1 kg



	€	1	024240022
T22	180,00	1	024240022
TV20	30,00	1	024000488

T23



42INOX 8-10-11-12-13-14-15-17-19 mm
Ø96BPINOX 2,5-3-4-5-6-8-10 mm

1 kg



	€	1	024240023
T23	312,00	1	024240023
TV23	30,00	1	024249906

T31



31 Ø2-3-4-5-6 mm
32 Ø4 mm
55 6x7-8x9-10x11
12x13-14x15
16x17-18x19
20x22-21x23
24x26-27x29
30x32 mm
Ø96N/SC9 1,5+10 mm

3 kg



	€	1	024240031
T31	255,00	1	024240031
TV30	39,50	1	024000401

T33



55
6x7-8x9-10x11
12x13-14x15
16x17-18x19
20x22 mm
○96/SC9 1,5+10 mm

1 kg



T33	108,00	1	024240033
TV20	30,00	1	024000488

T34



55MP
6x7-8x9-10x11
12x13-14x15
16x17-18x19
20x22 mm
○96/SC9 1,5+10 mm

1 kg



T34	137,00	1	024240034
TV20	30,00	1	024000488

T40



90
6x7-8x9-10x11
12x13-14x15
16x17-18x19 mm

810 g



T40	119,00	1	024240040
TV40	30,00	1	024000456

T41



90
20x22-21x23
24x26-25x28
27x29 mm

1,5 kg



T41	176,00	1	024240041
TV41	30,00	1	024000457

T45



142
8-9-10-11-12
13-14-15-16
17-18-19 mm

1,3 kg



T45	353,00	1	024240045
TV45	30,00	1	024000498

T46



142SN
8-9-10-11-12
13-14-15-16
17-18-19 mm

1,5 kg



T46	422,00	1	024240046
TV46	30,00	1	024000499

T48



○96BPC/SC9 1,5+10 mm
142C 8-9-10-11-12
13-14-15-16
17-18-19 mm

1,4 kg



T48	300,00	1	024240048
TV47	30,00	1	024000763

T50



○96T 2-2,5-3-3,5-4-4,5
5-6-7-8-10 mm

1,3 kg



T50	201,00	1	024240050
TV50	39,50	1	024000764

T52



○96T 2-2,5-3-4-5-6 mm

350 g



T52	98,00	1	024240052
TV52	30,00	1	024000765

T55



○97TTX T10-T15-T20
T25-T27-T30

330 g



T55	113,00	1	024240055
TV55	30,00	1	024000766

T59



111E 250 mm
920/40 ■ 1/2
951 2,5-3-4-5-6-8 mm
○953 4-5-6-8 mm
1370 300 - 500 g

4,7 kg



T59	505,00	1	024240059
TV60	59,50	1	024000420

T63



○952 7 - 8 - 10 - 12 - 13 - 14 - 17 - 19 mm

3,8 kg



T63	382,00	1	024240063
TV63	49,00	1	024000471

T64



- 952FTX E10-E12-E14
- 953TX T25 - T27 - T30 - T40 - T45

3,8 kg



T64	€ 468,00	1	024240064
TV63	€ 49,00	1	024000471

T65



- 953 3 - 3,5 - 4 - 5 - 6 - 7 - 8 - 10 mm

2,8 kg



T65	€ 369,00	1	024240065
TV63	€ 49,00	1	024000471

T68



- 951 2,5-3-4-5-6-8 mm

590 g



T68	€ 163,50	1	024240068
TV68	€ 30,00	1	024000470

T73



- 930 6x7 - 8x9 - 10x11 - 12x13 - 14x15 - 16x17 - 18x19 - 20x22 mm
- 940/1
- 940/2

1,3 kg



T73	€ 242,50	1	024240073
TV73	€ 30,00	1	024000418

T75



- 933 7-8-9-10-11-12-13 - 14-15-16-17-18-19 - 21-22-24 mm

4,2 kg



T75	€ 496,00	1	024240075
TV75	€ 59,50	1	024000422

T76



- 932 7-8-9-10-11-12-13 - 14-15-16-17-18-19 - 21-22-24 mm

4,2 kg



T76	€ 496,00	1	024240076
TV75	€ 59,50	1	024000422

T77



- 933 6-7-8-10-11-12-13 - 14-17-19 mm

1,4 kg



T77	€ 247,50	1	024240077
TV77	€ 30,00	1	024000474

T80



- 920A 10-11-12-13-14 - 15-16-17-18-19 - 20-21-22-23-24 - 26-27-30-32 mm
- 920ME 5-6-8-10-12 mm
- 920/21 125 mm
- 920/22 255 mm
- 920/25
- 920/42 305 mm
- 920/55

4,1 kg

12"



T80	€ 463,00	1	024240080
TV80	€ 39,50	1	024000403

T81



- 920B 10-11-12-13-14 - 15-16-17-18-19 - 20-21-22-23-24 - 26-27-30-32 mm
- 920ME 5-6-8-10-12 mm
- 920/21 125 mm
- 920/22 255 mm
- 920/25
- 920/42 305 mm
- 920/55

4,1 kg

12"



T81	€ 463,00	1	024240081
TV80	€ 39,50	1	024000403

T82



- 920A 10-11-12-13-14 - 15-16-17-18-19 - 20-21-22-23-24 - 26-27-30-32 mm
- 920ME 5-6-8-10-12 mm
- 920AN/125 125 mm
- 920AN/250 250 mm
- 920/25
- 920/42 305 mm
- 920/55

4,1 kg

12"



T82	€ 478,00	1	024240082
TV80	€ 39,50	1	024000403

T83



- 920A 10-11-12-13-14 - 15-16-17-18-19 - 20-21-22-23-24 - 26-27-30-32 mm
- 920/21 125 mm
- 920/22 255 mm
- 920/25
- 920/42 305 mm
- 920/55

3,6 kg

12"



T83	€ 359,00	1	024240083
TV83	€ 39,50	1	024000402



T85



- 861LP 0,5x3 - 0,6x4,5 - 0,8x5,5 - 1x5,5 - 1,2x6,5 - 1,2x8 - 1,6x8 mm
- 861PE 2 - 2,5 - 3 - 4 - 5 - 6 - 8 - 10 mm
- ⊕ 861PH PH0 - PH1 - PH2 - PH3
- ⊕ 861PZ PZ1 - PZ2 - PZ3
- ⊕ 861TX T6 - T7 - T8 - T9 - T10 - T15 - T20 - T25 - T27 - T30 - T40
- ⊕ 861RTX T9 - T10 - T15 - T20 - T25 - T27 - T30 - T40
- ⊕ 861TRW 1-2-3-4-5-6 mm
- ⊕ 861TQS 0 - 1 - 2 - 3 - 4 - 5 - 6 - 8 - 10 mm
- ⊕ 861SP 4-6-8-10-12 mm
- 851SR 230 mm
- 900 4-4,5-5-5,5-6-7-8-9 - 10-11-12-13-14 mm
- 900/21 150 mm
- 900/25 41 mm
- 900BG/30 176 mm
- 900/42 115 mm
- ⊕ 900/55 125 mm
- 194 1/4x5/16

1,0 kg

14"

T85	394,00	1	024240085
TV85	39,50	1	024000747

T91



- 900 4-4,5-5-5,5-6 - 7-8-9-10-11 - 12-13-14 mm
- 900ME 2,5-3-4-5-6-8 mm
- 900/20 50 mm
- 900/21 150 mm
- 900/25
- 900BG/30
- 900/42 115 mm
- ⊕ 900/55

560 g

14"

T91	358,00	1	024240091
TV90	30,00	1	024000447

T92



- 910A 6-7-8-9-10-11-12-13 - 14-15-16-17-18-19 - 20-21-22 mm
- 910/21 125 mm
- 910/22 250 mm
- 910/25
- 910/42 210 mm
- ⊕ 910/55

1,5 kg

38"

T92	283,00	1	024240092
TV92	30,00	1	024000458

T99



- 920INOX-A 10-12-13-14-15-16-17 - 18-19-21-22-24-27 - 30-32mm
- ⊕ 920/55INOX

2,7 kg

12"

T99	1.340,00	1	024240099
TV99	30,00	1	024249908

T100



- 920A 10-12-13-14-15 - 16-17-18-19-21 - 22-24 mm
- 920/21 125 mm
- 920/25
- 920/42 305 mm
- ⊕ 920/55

2,1 kg

12"

T100	257,00	1	024240100
TV100	30,00	1	024000495

T101



- 920B 10-12-13-14-15 - 16-17-18-19-21 - 22-24 mm
- 920/21 125 mm
- 920/25
- 920/42 305 mm
- ⊕ 920/55

2,1 kg

12"

T101	257,00	1	024240101
TV100	30,00	1	024000495

T102



- 920AS 3/8-7/16-1/2 - 9/16-5/8-11/16 - 3/4-13/16-7/8 - 15/16-1-1.1/16
- 920/21 125 mm
- 920/25
- 920/42 305 mm
- ⊕ 920/55

2,1 kg

12"

T102	280,00	1	024240102
TV100	30,00	1	024000495

T103



- 900L 6-7-8-9-10-11-12 mm
- 920AL 13-14-16-17-18-19 - 21-22-24-27 mm

1,1 kg

14" 12"

T103	337,00	1	024240103
TV103	30,00	1	024000748

T105



- 928A 22-24-27-30-32-34 - 36-38-41-46-50 mm

4,9 kg

34"

T105	335,00	1	024240105
TV105	30,00	1	024000484

T106



- 928/21 200 mm
- 928/22 380 mm
- 928/42 450 mm
- 928/55

4,5 kg

34"

T106	356,00	1	024240106
TV106	30,00	1	024000485

T111



- 720 10-13-15-17-18-19-21 - 22-24-27-30-32 mm
- 720LC 17-19-21 mm
- 720/21 125 mm

2,7 kg

12"

T111	289,00	1	024240111
TV111	30,00	1	024000476

T112



- 861TX ● 1/4-T6+T15
- 866TX ● 5/16-T20+T55
- 895/1 ○ 1/4x□1/4
- 895/6 ○ 5/16x□1/2
- 900FTX □ 1/4-E4+E10
- 920FTX □ 1/2-E12+E24
- 920TX □ 1/2-T55L-T60-T70L

1,3 kg

14" 12"



T112	€ 342,00	1	024240112
TV112	€ 30,00	1	024000480

T113



- 920PE 5L-6L-7L-8L-10L
- 920TX T40L-T45L
T55L-T70L
- 920XZN M6L-M8L-M12L

1,5 kg

12"



T113	€ 299,00	1	024240113
TV113	€ 30,00	1	024000489

T122



666/20 40 - 200 Nm

1,2 kg

12"



T122	€ 332,00	1	024240122
TV122	€ 31,00	1	024000768

T123



- 1082G 160 mm
- 1150G 180 mm
- 1166G 160 mm

550 g



T123	€ 91,00	1	024240123
TV135	€ 30,00	1	024000762

T124



- 1082GBM 160 mm
- 1150GBM 180 mm
- 1166GBM 160 mm

640 g



T124	€ 117,00	1	024240124
TV135	€ 30,00	1	024000762

T135



- 1082MQ 160 mm
- 1150MQ 180 mm
- 1166MQ 160 mm

1000 V

750 g



T135	€ 193,00	1	024240135
TV135	€ 30,00	1	024000762

T136



- 1048MQ 250 mm
- 1777MQ/U

1000 V

700 g



T136	€ 138,00	1	024240136
TV136	€ 30,00	1	024000438

T137



- 1084BM 160 mm
- 1150BM 180 mm
- 1166BM 160 mm

750 g



T137	€ 132,00	1	024240137
TV130	€ 30,00	1	024000451

T138



- 1084 160 mm
- 1150 180 mm
- 1166 160 mm

650 g



T138	€ 108,00	1	024240138
TV130	€ 30,00	1	024000451

T140



- 1032 140x0,9 - 180 mm
- 1034 170 mm
- 1036 140x1,3 - 175 mm
- 1038 175 mm
- 1084 160 mm
- 1128BM

1,1 kg



T140	€ 266,00	1	024240140
TV140	€ 39,50	1	024000405

T144



- 1048N 250 mm
- 1052 240 mm
- 1112 250 mm
- 1150 180 mm

1,8 kg



T144	€ 153,00	1	024240144
TV143	€ 39,50	1	024000409

T145



- 1032 180 mm
- 1034 170 mm
- 1036 175 mm
- 1038 175 mm

640 g



T145	€ 147,00	1	024240145
TV145	€ 30,00	1	024000448

T146



- 1032 140x0,9 mm
- 1032 225 mm
- 1036 140x1,3 mm
- 1036 225 mm

📦 700 g



T146	€ 154,00	1	024240146
TV146	€ 30,00	1	024000449

T151



- 1047 240 mm
- 1057A 240 mm

📦 1,3 kg



T151	€ 132,00	1	024240151
TV150	€ 30,00	1	024000462

T153



- 1048N 250 mm
- 1052 240 mm

📦 1,1 kg



T153	€ 80,00	1	024240153
TV150	€ 30,00	1	024000462

T156



- ◄ 1082 160 mm
- ◄ 1150 180 mm
- 1048N 250 mm

📦 1 kg



T156	€ 106,00	1	024240156
TV148	€ 30,00	1	024000500

T157



- ◄ 1082BM 160 mm
- ◄ 1150BM 180 mm
- 1048BM 250 mm

📦 1,1 kg



T157	€ 145,00	1	024240157
TV148	€ 30,00	1	024000500

T160



- 1290 3x75
- 3x100
- 4x100
- 4x150
- 5,5x100
- 5,5x150
- 6,5x150
- 8x150
- 10x200 mm
- 1290N 4x30
- 6,5x30 mm

📦 1,3 kg



T160	€ 160,00	1	024240160
TV160	€ 39,50	1	024000706

T161



- 1292 PH0x60
- PH0x100
- PH1x80
- PH1x120
- PH2x100
- PH2x150
- PH3x150 mm
- 1292N PH1x30
- PH2x30 mm

📦 1 kg



T161	€ 125,00	1	024240161
TV161	€ 39,50	1	024000707

T164



- 952 8-10-13-17-19 mm
- 959 16 mm (5/8") - 20,8 mm (13/16")
- 1260 3x75 - 4x100 - 5,5x100 - 6,5x150 - 10x200 mm
- 1262 PH0x60 - PH1x80 - PH2x100 - PH3x150 mm

📦 5 kg



T164	€ 537,00	1	024240164
TV61	€ 59,50	1	024000721

T167



- 1260 3x75
- 3x100
- 4x100
- 4x150
- 5,5x100
- 5,5x150
- 6,5x150
- 8x150
- 10x200 mm
- 1260N 4x30
- 6,5x30 mm

📦 1,3 kg



T167	€ 129,00	1	024240167
TV160	€ 39,50	1	024000706

T168



- 1262 PH0x60
- PH0x100
- PH1x80
- PH1x120
- PH2x100
- PH2x150
- PH3x150 mm
- 1262N PH1x30
- PH2x30 mm

📦 1 kg



T168	€ 103,00	1	024240168
TV161	€ 39,50	1	024000707

T170



- 1290 2,5x50
- 3x75
- 3,5x100
- 4x125
- 5,5x100
- 5,5x150
- 6,5x150 mm

📦 450 g



T170	€ 86,50	1	024240170
TV170	€ 30,00	1	024000741

T171



- 1290 8x150
- 8x200
- 10x200 mm
- 1290N 4x30
- 6,5x30 mm

📦 750 g



T171	€ 95,50	1	024240171
TV171	€ 30,00	1	024000742

T172

Betam X



1292 PH0x60
PH0x100
PH1x80
PH1x120
PH2x100
PH2x150 mm

450 g



T172	€ 79,00	1	024240172
TV172	€ 30,00	1	024000743

T177

Betam X



1298RTX T9-T10-T15
T20-T25-T27
T30-T40

680 g



T177	€ 173,00	1	024240177
TV177	€ 30,00	1	024000759

T199



1260 2,5x50
3x75
3,5x100
4x125
5,5x100
5,5x150
6,5x150 mm

490 g



T199	€ 68,50	1	024240199
TV170	€ 30,00	1	024000741

T173

Betam X



1292 PH3x150
PH4x200 mm
1292N PH1x30
PH2x30 mm

560 g



T173	€ 77,50	1	024240173
TV173	€ 30,00	1	024000744

T180

Betam X



1290 3x75
4x100
5,5x150
6,5x150 mm
1292 PH0x60
PH1x80
PH2x100 mm

480 g



T180	€ 90,00	1	024240180
TV180	€ 30,00	1	024000701

T201



1260 8x200
10x150
10x200 mm
1260N 4x30
6,5x30 mm

680 g



T201	€ 75,00	1	024240201
TV171	€ 30,00	1	024000742

T175

Betam X



1297TX T6-T7-T8-T9
T10-T15-T20

410 g



T175	€ 123,00	1	024240175
TV175	€ 30,00	1	024000760

T183

Betam X



1292L PH1x400-PH2x400 mm
1294L 3x300-4x400-5x400 mm

580 g



T183	€ 122,00	1	024240183
TV183	€ 30,00	1	024000497

T202



1262 PH0x60
PH0x100
PH1x80
PH1x120
PH2x100
PH2x150 mm

490 g



T202	€ 63,00	1	024240202
TV172	€ 30,00	1	024000743

T176

Betam X



1297TX T25-T27-T30
T40-T45

640 g



T176	€ 114,00	1	024240176
TV176	€ 30,00	1	024000761

T198

1260 3x75
4x100
5,5x150
6,5x150 mm
1269PZ PZ0 - PZ1 - PZ2

490 g



T198	€ 76,50	1	024240198
TV180	€ 30,00	1	024000701

T204



1262 PH3x150
PH4x200 mm
1262N PH1x30
PH2x30 mm

610 g



T204	€ 62,00	1	024240204
TV173	€ 30,00	1	024000744

T205



1267TX T6-T7-T8-T9
T10-T15-T20

460 g



T205	90,00	1	024240205
TV175	30,00	1	024000760

T209



1262L PH1x400-PH2x400 mm
1264L 3x300 - 4x400 - 5x400 mm

580 g



T209	90,50	1	024240209
TV183	30,00	1	024000497

T221



1201E 3x75
4x100
5,5x150
6,5x150 mm
1202E PH0x60
PH1x80
PH2x100 mm

530 g



T221	51,50	1	024240221
TV180	30,00	1	024000701

T206



1267TX T25-T27-T30
T40-T45

710 g



T206	92,50	1	024240206
TV176	30,00	1	024000761

T211



1201E 2,5x50
3x75
3,5x100
4x125
5,5x100
5,5x150
6,5x150 mm

490 g



T211	48,50	1	024240211
TV170	30,00	1	024000741

T226



1274MQ 3x100
4x100
5,5x125
6,5x150 mm
1272MQ PH0x60
PH1x80
PH2x100 mm

1000 V

460 g



T226	112,00	1	024240226
TV180	30,00	1	024000701

T207



1268RTX T9-T10-T15
T20-T25-T27-T30

760 g



T207	111,00	1	024240207
TV207	30,00	1	024000758

T213



1202E PH0x60
PH1x80
PH1x120
PH2x100
PH2x150
PH3x150 mm

490 g



T213	53,00	1	024240213
TV212	30,00	1	024000440

T227



944BX 5-6-7-8-10-13 mm

490 g



T227	158,00	1	024240227
TV227	30,00	1	024000705

T208



1260 3x75
4x100
5,5x150
6,5x150 mm
1262 PH0x60
PH1x80
PH2x100 mm

530 g



T208	72,50	1	024240208
TV180	30,00	1	024000701

T216



1207E/TX T6-T7-T8-T9
T10-T15-T20

410 g



T216	67,50	1	024240216
TV175	30,00	1	024000760

T228



1290INOX 3x75 - 4x100 -
5,5x150 - 6,5x150 mm
1292INOX PH0x60
- PH1x80 - PH2x100
mm



480 g



T228	101,00	1	024240228
TV180	30,00	1	024000701

T231



- 1370 400 g
- 1390 Ø 35 mm
- ▲ 1719BMA/T 200 mm
- 1719BMA/P 200 mm
- ▷ 1719BMA/M 200 mm

1,7 kg



T231	€ 138,00	1	024240231
TV230	€ 39,50	1	024000411

T233



- 35 100-200 mm
- 1370F 32 mm
- 1390 Ø 35 mm

1,3 kg



T233	€ 126,00	1	024240233
TV232	€ 30,00	1	024000452

T234



- 35 100-200 mm
- 1370 300 g
- 1390 Ø 35 mm

1,3 kg



T234	€ 114,00	1	024240234
TV232	€ 30,00	1	024000452

T236



- 1719BMA/Q 200 mm
- ▲ 1719BMA/T 200 mm
- 1719BMA/P 200 mm
- ▷ 1719BMA/M 200 mm
- 1719BMA/R 200 mm

870 g



T236	€ 112,00	1	024240236
TV235	€ 30,00	1	024000453

T239



- 31BM Ø 2-3-4-5-6-8 mm
- 32 Ø 4 mm

850 g



T239	€ 149,00	1	024240239
TV239	€ 30,00	1	024000439

T241



- 1500N/1
- 1500N/3
- 1516/1

4,2 kg



T241	€ 347,00	1	024240241
TV241	€ 39,50	1	024000414

T259



- 96BP 2,5-3-4-5
6-8-10 mm
- 96N 12 mm
- 860MIX/A31
-
- +
- +
- +
- 895/1

950 g



T259	€ 174,00	1	024240259
TV263	€ 30,00	1	024000492

T264



- 1491 Ø 65+110 mm
- 1494 10 mm
- 1494E ○ 8-9-10-11-12-14-17 mm
- 1494Q ○ 8-9,5-12-13 mm
- △ 1494T △ 9,5
- 1494XZN ○ 16
- 1496C ■ 8x ■ 10 mm

2,1 kg



T264	€ 260,00	1	024240264
TV264	€ 30,00	1	024000466

T270

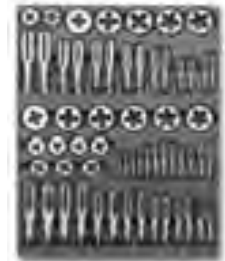

- 430 M3 - 4 - 5 - 6 - 7 - 8 - 9
10 - 12 - 14 - 16 - 18 - 20
- 433 M6x0,75 - M8x1 - M10x1,25
M12x1,5 - M14x1,5
M16x1,5 - M18x1,5
- 440 M3 - 4 - 5 - 6 - 7 - 8 - 9
- 440A M10 - 12 - 14 - 16 - 18 - 20
- 441 M6x0,75 - M8x1,0
- 441A M10x1,25 - M12x1,5
M14x1,5 - M16x1,5
M18x1,5

4,3 kg



T270	€ 599,00	1	024240270
TV270	€ 39,50	1	024000481

T273



- 435/1,5 M3+M12
- 435/3 M5+M21
- 436/1 □ 2,0+5,0 mm
(M3+M8)
- 436/2 □ 4,6+8 mm
(M5+M12)
- 444/1 Ø 25,4 mm
- 444/2 Ø 38,1 mm
- 1707 W 62+4x1"

2,1 kg



T273	€ 276,00	1	024240273
TV272	€ 39,50	1	024000482

T281



- 1741B 250 mm
- 1741RV2,9K 2,9x6 mm (100)
- 1741RV3,2K 3,2x8 mm (100)
- 1741RV3,8K 3,8x10 mm (100)
- 1741RV4K 4x12 mm (100)

1,4 kg



T281	€ 86,50	1	024240281
TV280	€ 30,00	1	024000478



T279



- 1112 250 mm
- 1128BM
- 1726 400 mm
- 1728BM (x5)
- 1751N 200 cc

1,5 kg



	€	Icon	Code
T279	148,00	1	024240279
TV285	49,00	1	024000487

T284



- 1128BMX
- 1130BMX
- 1719BMA...Q 200 mm
- ▲ 1719BMA...T 200 mm
- 1719BMA...P 200 mm
- ▶ 1719BMA...M 200 mm
- 1719BMA...R 200 mm
- 1726BM 400 mm
- 1728BM
- 1771BM 170 mm
- 1778V18 185 mm

3,3 kg



	€	Icon	Code
T284	295,00	1	024240284
TV286	59,50	1	024249904



T291



- 1479RB/1
- 1479RB/2
- 1479RB/3

600 g



	€	Icon	Code
T291	118,00	1	024240291
TV291	30,00	1	024000472

T294



- 1692 5 m
- 1725CR
- 1771RL
- 1771

590 g



	€	Icon	Code
T294	81,00	1	024240294
TV294	30,00	1	024000491

T297



- 1651DGTB
- 1682
- 1691BM

490 g



	€	Icon	Code
T297	183,00	1	024240297
TV296	30,00	1	024000749



VP1 - VP2

Thermoformateinsätze für Kleinteile, aus Kunststoff, für Werkzeugkästen RSC22, RSC23, RSC23C

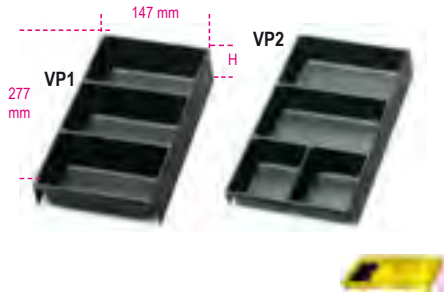

	H mm	€	1	088880351
VP1	50	17,20	1	088880351
VP2	35	17,20	1	088880352

VP3 - VP4

Thermoformateinsätze für Kleinteile, aus Kunststoff, für Werkzeugwagen und Werkzeugkasten

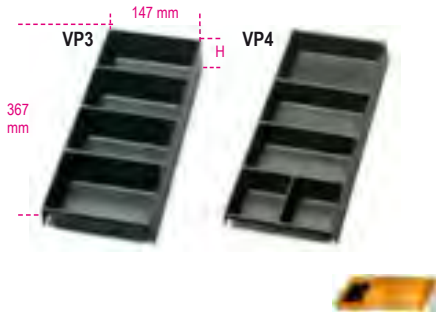

	H mm	€	1	088880353
VP3	50	18,10	1	088880353
VP4	35	18,10	1	088880354

VP5

Thermoformateinsatz



	€	1	088880355
VP5	20,40	1	088880355

VP6

Thermoformateinsatz



	€	1	088880359
VP6	20,70	1	088880359

VP-3SC

Thermoformateinsätze für Kleinteile, aus Kunststoff, für Werkzeugwagen C38 +C04TSS-7

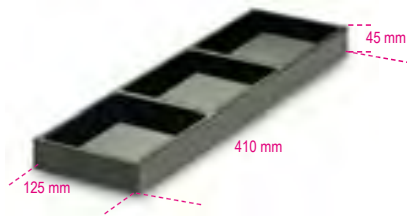

	H mm	€	1	088880356
VP-3SC	45	21,70	1	088880356

VP-LS

Thermoformateinsätze für Kleinteile, aus Kunststoff, für Werkzeugwagen C38 +C04TSS-7



	H mm	€	1	088880357
VP-LS	45	14,80	1	088880357

VP-LD

Thermoformateinsätze für Kleinteile, aus Kunststoff, für Werkzeugwagen C38



	H mm	€	1	088880358
VP-LD	45	14,30	1	088880358

8889P1

Längsunterteilungen für Art. RSC22, RSC23, RSC23C und C27S
Schublade 588x277 mm



	h	€	1	088890005
8889P1/5	50 mm	57,50	1	088890005
8889P1/7	70 mm	59,00	1	088890007

8889C1

Längs- und Querunterteilungen für Art. RSC22, RSC23, RSC23C und Art. C27S
Schublade 588x277 mm



	h	€	1	088890015
8889C1/5	50 mm	76,50	1	088890015
8889C1/7	70 mm	78,50	1	088890017

8889P2

Längsunterteilungen für Standardschublade Art. 588x367 mm

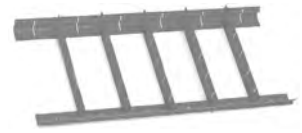

	h	€	1	088890107
8889P2/7	70 mm	69,00	1	088890107

8889C2

Längs- und Querunterteilungen für Standardschublade Art. 588x367 mm

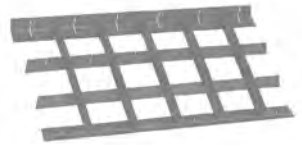

	h	€	1	088890117
8889C2/7	70 mm	88,50	1	088890117

8889P3

Längsunterteilungen für Art. RSC24AXL

Schublade 882x367 mm



	h	€	1	088890207
8889P3/7	70 mm	110,50	1	088890207

8889C3

Längs- und Querunterteilungen für Art. RSC24AXL
Für Schublade 882x367 mm

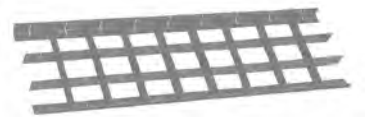

	h	€	1	088890217
8889C3/7	70 mm	134,00	1	088890217

8889P4

Längsunterteilungen für Trolley Art. C41

Schublade 418x205 mm



	h	€	1	088890307
8889P4/7	70 mm	46,00	1	088890307

8889I4

Längs- und Querunterteilungen für Trolley Art. C41

Schublade 418x205 mm



	h	€	1	088890317
8889C4/7	70 mm	56,00	1	088890317

8889PS

Längsunterteilungen für Art. C38 - C45PRO
M4/M5/M7/M8
Linksseitige Schublade 570x410 mm



8889PS/7	h 70 mm	€ 81,50	1	088890407
----------	------------	------------	---	-----------

8889CS

Längs- und Querunterteilungen für Art. C38 - C45PRO M4/M5/M7/M8
Linksseitige Schublade 570x410 mm

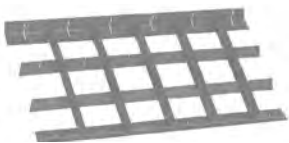

8889CS/7	h 70 mm	€ 99,50	1	088890417
----------	------------	------------	---	-----------

8889PD

Längsunterteilungen für Art. C38

Rechtsseitige Schublade 313x410 mm



8889PD/7	h 70 mm	€ 43,50	1	088890427
----------	------------	------------	---	-----------

8889CD

Längs- und Querunterteilungen für Art. C38

Rechtsseitige Schublade 313x410 mm

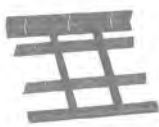

8889CD/7	h 70 mm	€ 60,00	1	088890437
----------	------------	------------	---	-----------

8889C6

Längs- und Querunterteilungen für Art. C35

Schublade 600x447 mm



8889C6/7,5	h 75 mm	€ 43,00	1	088890475
8889C6/10	100 mm	41,50	1	088890480
8889C6/15	150 mm	52,00	1	088890485
8889C6/20	200 mm	81,00	1	088890490

SB

Steckschlüsselschienen



	L mm	€	10	088880201
SB1	210	4,40	10	088880202
SB2	280	5,00	10	088880203
SB3	360	5,20	10	088880203

PM 1/2-Q5

Steckschlüsselschiene, magnetisch



PM 1/2-Q5	€ 53,50	1	088880233
-----------	------------	---	-----------

MB

Federklammern für Schienen SB



	□	€	50	088880210
MB0	1/4	1,40	50	088880211
MB1	3/8	1,40	50	088880212
MB2	1/2	1,40	50	088880212

KIT/GPS

Satz GPS Haken 40 mm mit Schrauben VE1

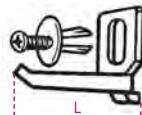

	€	50	088880119
KIT/GPS-40 mm	2,60	50	088880117
KIT/GPS-90 mm	4,00	50	088880117

VE1

Expansionsschrauben

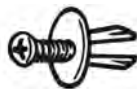

VE1	€ 0,90	20	088880120
-----	-----------	----	-----------

GM

Federhaken mit Expansionsschraube VE1



	Ø mm	€	5	088880250
	6,5	8,10	5	088880251
	9,5	8,40	5	088880252
	13	8,40	5	088880253
	16	9,80	5	088880254
	19	10,30	5	088880255
	25	9,80	5	088880255

S55/8

Halter für 8 Maulschlüssel, aus Blech

• Geliefert mit 3 Expansionsschrauben VE1

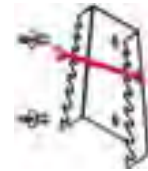

S55/8	€ 27,50	1	088880420
55/S8			
55AS/8			
55MP/S8			

S55/12

Halter für 12 Maulschlüssel, aus Blech

• Geliefert mit 3 Expansionsschrauben VE1

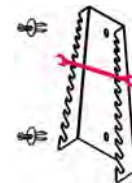

S55/12	€ 33,50	1	088880421
55/S12			
55/S12X			
55AS/12			
55MP/S12			

ST2P

Zangenhalter, aus Blech

• Geliefert mit 3 Expansionsschrauben VE1

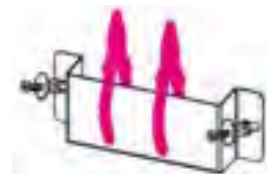

ST2P	€ 30,00	1	088880422
------	------------	---	-----------

TSPP

Werkzeughalter, aus Kunststoff

• Geliefert mit 3 Expansionsschrauben VE1

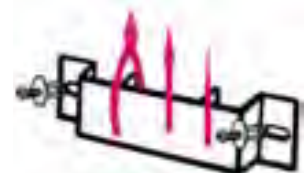

TSPP	€ 6,80	1	088880402
------	-----------	---	-----------

S952/10

Halter für 10 Stiftschlüssel mit T-Griff, aus Blech

• Geliefert mit 4 Expansionsschrauben VE1



S952/10	€ 36,00	1	088880423
---------	------------	---	-----------

S1719BM

Halter für 5 Feilen, aus Blech

• Geliefert mit 3 Expansionsschrauben VE1



S1719BM	€	1	088880404
1719BMA: Q-T-P-M-R	20,70		
1719BMD: Q-T-P-M-R			
1719BMX: Q-T-P-M-R			

SGN

Halter für 2 Nano-Schraubendreher, aus Blech

• Geliefert mit 3 Expansionsschrauben VE1

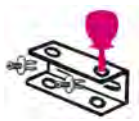

SGN	€	1	088880405
1290N-1292N-1299N/PZ	10,50		
1260N-1262N-1269N/PZ			
1201EN-1202EN-1209EN/PZ			

CB/2

Fester Thermoformateinsatz für Steckschlüssel und Betätigungswerkzeuge 1/2", leer

• Nur für C54S

12"



CB/2	€	1	088880411
920A/920B	31,50		
10÷24+26-27			
28-30-32 mm			
920/21-920/22-920/25-			
920/42-920/55			

S42/17

Halter für 17 Ring-Maulschlüssel, aus Blech

• Geliefert mit 3 Expansionsschrauben VE1

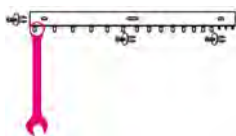

S42/17	€	1	088880428
42/S17	35,00		
42MP/S17			
42/S17X			
42AS/17			
142/S17			

S951/6

Halter für 6 Stiftschlüssel mit T-Griff, aus Blech

• Geliefert mit 3 Expansionsschrauben VE1



S951/6	€	1	088880429
951/S6	23,40		
951AS/S6X			
951TX/S6			

SPG11 - S1203/8

Halter für Schraubendreher, aus Blech

• Geliefert mit 3 Expansionsschrauben VE1



SPG11	€	1	088880910
n.8 Ø = 7 mm	24,30		
n.2 Ø = 10 mm			
n.1 Ø = 12 mm			
S1203/8	€	1	088880430
1203E/S8	26,00		
1263/D8			
1293/S8			

S96T/8

Halter für 8 Sechskant-Stiftschlüssel mit Griff, aus Blech

• Geliefert mit 3 Expansionsschrauben VE1



S96T/8	€	1	088880431
96T/AS8	26,00		
96T/S8			
97TTX/S8			

96T/SPV

Halter für 11 Sechskant-Stiftschlüssel mit Griff, aus Blech

• Geliefert mit 3 Expansionsschrauben VE1

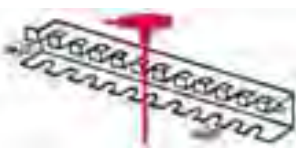

96T/SPV	€	1	000960958
96T/S11	50,50		
97TTX/S11			





Beta CHEMICALS

Nicht immer reicht es einen Bolzen anzuziehen, damit er festsitzt. Er muss gesäubert, geschmiert, versiegelt werden.

Die Familie umfasst anaerobe Dicht- und Versiegelungstoffe, Cyanacrylatkleber und Aerosol für die Wartung, Reinigung und Schmierung von mechanischen Komponenten.

Anaerobe Produkte

Anaerobe Produkte garantieren die vollständige Füllung von kleinen Oberflächenunregelmäßigkeiten des Metalls, sodass die Verteilung der mechanischen Belastungen auf der gesamten Verbindungsoberfläche gewährleistet wird. Sie härten anaerob aus, d.h. sie härten nur dort, wo kein Sauerstoff an den Klebstoff gelangt, und dichten so die Verbindung oder das Gewinde vollständig gegen Wasser, Gas, Öl, Kraftstoff und Industrieflüssigkeiten ab.

Sie sind in drei Festigkeitsklassen verfügbar: hart (H), mittelhart (M) und leicht (L). Sie sind in verschiedenen Verpackungen erhältlich, um den verschiedenen Ansprüchen gerecht zu werden.

Silikondichtstoff

Die Silikondichtstoffe ermöglichen dauerhafte elastische Abdichtungen, die das Eindringen kleiner Substanzen (Schmutz, Staub usw.) in die Fuge verhindern und vorgeformte Dichtungen ersetzen. Dank ihrer elastischen Eigenschaft sind sie in der Lage, Bewegungen ohne innere Ausdehnung oder Bruch zu absorbieren. Die Silikondichtstoffe polymerisieren durch Reaktion mit Luftfeuchtigkeit und bilden eine elastische und widerstandsfähige Dichtung. Die Produktverteilung wird durch einen praktischen Spender (Druckpackung) erleichtert. Auch einhändig verwendbar, mit garantiert präziser und gleichmäßiger Verteilung des Produkts.

Sofortkleber

Kleber auf der Basis von Ethylcyanoacrylat, für strukturelle Verbindungen von verschiedenen Materialien.

Aerosol

Breitgefächerte Palette von Produkten in Sprühflaschen zum Entsperrn, Einfetten, Schmieren, Reinigen, Verzinken und Desinfizieren.

Flüssigkeiten

Wurden zum Entfernen von Verkrustungen und Rost von mechanischen Teilen und Metallgegenständen entwickelt. Ideal für die Anwendung in den Ultraschall-Reinigungsgeräten 1895.



ACHTUNG

Länder, in denen die Produkte Beta Chemicals vertrieben werden können: Österreich, Andorra, Belgien, Vereinigte Arabische Emirate, Frankreich, Italien, Neukaledonien, Niederlande, Polen, Portugal, Monaco, Vereinigtes Königreich, Tschechische Republik, Republik Irland, Dominikanische Republik, Republik China, Réunion, San Marino, Slowakei, Slowenien, Spanien, Schweiz, Ungarn

9803H

Schraubensicherung-Hohe Festigkeit

Dauerhafte Sicherung, ideal auf Teilen, die nicht demontiert werden müssen, oder für Anwendungen auf passivierten Metalloberflächen wie Messing, Aluminium, Edelstahl usw. Ein Entfernen mit manuellem Werkzeug ist nicht möglich.



Temperatur (°C)	-50/+150
Diametrales Spiel (mm)	0,25
Handfestigkeits-Aushärtezeit (minuten)	10/15
Funktionale Aushärtung (Stunden)	3-6
Viskosität (mPa.s) 25°C	800/1200
Losbrechmoment ISO-10964	35-45 Nm
Weiterdrehmoment ISO-10964	30-40 Nm

ml	Flasche	€	12	098030002
20	Flasche	13,40	12	098030002
50	Flasche	20,30	4	098030005
250	Flasche	51,00	4	098030025
20	Flasche		12	098032002
50	Flasche		4	098032005
250	Flasche		4	098032025

9802M

Schraubensicherung-Mittlere Festigkeit

Ideal zum leichten anhaften und fixieren von Teilen, die einer regelmäßigen Wartung unterzogen werden müssen. Mit normalem Handwerkzeug leicht demontierbar.



Temperatur (°C)	-50/+150
Diametrales Spiel (mm)	0,15
Handfestigkeits-Aushärtezeit (minuten)	10/15
Funktionale Aushärtung (Stunden)	3-6
Viskosität (mPa.s) 25°C	500/800
Losbrechmoment ISO-10964	22-30 Nm
Weiterdrehmoment ISO-10964	20-25 Nm

ml	Flasche	€	12	098020002
20	Flasche	13,40	12	098020002
50	Flasche	20,30	4	098020005
250	Flasche	51,00	4	098020025
20	Flasche		12	098022002
50	Flasche		4	098022005
250	Flasche		4	098022025

9801L

Schraubensicherung-Niedrige Festigkeit

Ideal zum bremsen Werkteile aus leichten Legierungen, die während dem Demontieren beschädigt werden könnten, oder für Stellschrauben. Erleichterter Ausbau der Teile.



Temperatur (°C)	-50/+150
Diametrales Spiel (mm)	0,10
Handfestigkeits-Aushärtezeit (minuten)	10/15
Funktionale Aushärtung (Stunden)	3-6
Viskosität (mPa.s) 25°C	500/800
Losbrechmoment ISO-10964	6-10 Nm
Weiterdrehmoment ISO-10964	4-8 Nm

ml	Flasche	€	12	098010002
20	Flasche	13,40	12	098010002
50	Flasche	20,30	4	098010005
250	Flasche	51,00	4	098010025
20	Flasche		12	098012002
50	Flasche		4	098012005
250	Flasche		4	098012025

9813H

Gewindedichtung-Hohe Festigkeit

Ideal für dauerhafte Versiegeln und Abdichten Gewindeverbindungen, die nicht demontiert werden müssen, oder für Anwendungen auf passivierten Metalloberflächen wie Messing, Aluminium, Edelstahl usw. Ermöglicht nicht das Entfernen mit manuellen Werkzeugen.



Temperatur (°C)	-50/+200
Diametrales Spiel (mm)	0,15
Handfestigkeits-Aushärtezeit (minuten)	10/15
Funktionale Aushärtung (Stunden)	3-6
Viskosität (mPa.s) 25°C	40.000/80.000
Losbrechmoment ISO-10964	35-45 Nm
Weiterdrehmoment ISO-10964	25-35 Nm

ml	Flasche	€	12	098130002
20	Flasche	12,00	12	098130002
50	Blasebalg	20,80	6	098130305
50	Tube	19,50	4	098130505
250	Tube	48,00	4	098130525
20	Flasche		12	098132002
50	Blasebalg		6	098132305
50	Tube		4	098132505
250	Tube		4	098132525

9812M

Gewindedichtung-Mittlere Festigkeit

Ideal für Versiegeln und Abdichten Gewindeverbindungen, die einer regelmäßigen Wartung unterzogen werden müssen. Mit normalem Handwerkzeug leicht demontierbar.



Temperatur (°C)	-50/+150
Diametrales Spiel (mm)	0,35
Handfestigkeits-Aushärtezeit (minuten)	12/18
Funktionale Aushärtung (Stunden)	3-6
Viskosität (mPa.s) 25°C	20.000/40.000
Losbrechmoment ISO-10964	27-35 Nm
Weiterdrehmoment ISO-10964	20-30 Nm

ml	Flasche	€	12	098120002
20	Flasche	12,00	12	098120002
50	Blasebalg	20,80	6	098120305
50	Tube	19,50	4	098120505
250	Tube	48,00	4	098120525
20	Flasche		12	098122002
50	Blasebalg		6	098122305
50	Tube		4	098122505
250	Tube		4	098122525

9811L

Gewindedichtung-Niedrige Festigkeit

Ideal für Versiegeln und Abdichten Gewindeverbindungen von kleine Kupplungen. Erleichterter Ausbau der Teile.



Temperatur (°C)	-50/+150
Diametrales Spiel (mm)	0,20
Handfestigkeits-Aushärtezeit (minuten)	10/15
Funktionale Aushärtung (Stunden)	3-6
Viskosität (mPa.s) 25°C	10.000/20.000
Losbrechmoment ISO-10964	6-10 Nm
Weiterdrehmoment ISO-10964	4-8 Nm

ml	Flasche	€	12	098110002
20	Flasche	12,00	12	098110002
50	Blasebalg	20,80	6	098110305
50	Tube	19,50	4	098110505
250	Tube	48,00	4	098110525
20	Flasche		12	098112002
50	Blasebalg		6	098112305
50	Tube		4	098112505
250	Tube		4	098112525

9823H

Flüssigdichtung-Hohe Festigkeit

Ideal für permanenten Versiegeln von Oberflächen.
Ideal für das Wiederherstellen von Lageraufnahmen oder abgenutzten Teilen.
Ermöglicht nicht das Entfernen mit manuellen Werkzeugen.



Temperatur (°C)	-50/+150
Diametrales Spiel (mm)	0,35
Handfestigkeits-Aushärtezeit (minuten)	10/16
Funktionale Aushärtung (Stunden)	3-6
Viskosität (mPa.s) 25°C	100.000/200.000
Losbrechmoment ISO-10964	35-45 Nm
Weiterdrehmoment ISO-10964	20-30 Nm

ml		€			
20	Flasche	12,00	12	098230002	
50	Blasebalg	20,80	6	098230305	
50	Tube	19,50	4	098230505	
250	Tube	48,00	4	098230525	
20	Flasche		12	098232002	
50	Blasebalg		6	098232305	
50	Tube		4	098232505	
250	Tube		4	098232525	

9822M

Flüssigdichtung-Mittlere Festigkeit

Ideal für Versiegeln und Abdichten von Oberflächen, die einer regelmäßigen Wartung unterzogen werden müssen.
Mit normalem Handwerkzeug leicht demontierbar.



Temperatur (°C)	-50/+150
Diametrales Spiel (mm)	0,35
Handfestigkeits-Aushärtezeit (minuten)	10/15
Funktionale Aushärtung (Stunden)	3-6
Viskosität (mPa.s) 25°C	40.000/70.000
Losbrechmoment ISO-10964	25-35 Nm
Weiterdrehmoment ISO-10964	20-30 Nm

ml		€			
20	Flasche	12,00	12	098220002	
50	Blasebalg	20,80	6	098220305	
50	Tube	19,50	4	098220505	
250	Tube	48,00	4	098220525	
20	Flasche		12	098222002	
50	Blasebalg		6	098222305	
50	Tube		4	098222505	
250	Tube		4	098222525	

9821L

Flüssigdichtung-Niedrige Festigkeit

Ideal für Versiegeln und Abdichten von Oberflächen, die oft gewartet werden müssen.
Verträgt leichte Ölverschmutzung.
Schützt die Gewinde vor Korrosion und Festsetzen.
Erleichterter Ausbau der Teile.



Temperatur (°C)	-50/+150
Diametrales Spiel (mm)	0,35
Handfestigkeits-Aushärtezeit (minuten)	20/30
Funktionale Aushärtung (Stunden)	3-6
Viskosität (mPa.s) 25°C	60.000/90.000
Losbrechmoment ISO-10964	7-11 Nm
Weiterdrehmoment ISO-10964	4-9 Nm

ml		€			
20	Flasche	12,00	12	098210002	
50	Blasebalg	20,80	6	098210305	
50	Tube	19,50	4	098210505	
250	Tube	48,00	4	098210525	
20	Flasche		12	098212002	
50	Blasebalg		6	098212305	
50	Tube		4	098212505	
250	Tube		4	098212525	

9833H

Fügestoff-Hohe Festigkeit

Ideal zum Blockieren Teilen, die nicht demontiert werden müssen.
Eignet zum Sichern von bereits installierten Bauteilen, die sehr schlecht auszubauen sind.
Ermöglicht nicht das Entfernen mit manuellen Werkzeugen.



Temperatur (°C)	-50/+180
Diametrales Spiel (mm)	0,15
Handfestigkeits-Aushärtezeit (minuten)	10/15
Funktionale Aushärtung (Stunden)	3-6
Viskosität (mPa.s) 25°C	400/700
Losbrechmoment ISO-10964	35-45 Nm
Weiterdrehmoment ISO-10964	30-40 Nm

ml		€			
20	Flasche	12,50	12	098330002	
50	Flasche	19,50	4	098330005	
250	Flasche	49,50	4	098330025	
20	Flasche		12	098332002	
50	Flasche		4	098332005	
250	Flasche		4	098332025	

9832M

Fügestoff-Mittlere Festigkeit

Ideal zum Blockieren Teile, die einer regelmäßigen Wartung unterzogen werden müssen.
Mit normalem Handwerkzeug leicht demontierbar.



Temperatur (°C)	-50/+180
Diametrales Spiel (mm)	0,25
Handfestigkeits-Aushärtezeit (minuten)	12/20
Funktionale Aushärtung (Stunden)	3-6
Viskosität (mPa.s) 25°C	2000/4000
Losbrechmoment ISO-10964	25-35 Nm
Weiterdrehmoment ISO-10964	18-28 Nm

ml		€			
20	Flasche	12,50	12	098320002	
50	Flasche	19,50	4	098320005	
250	Flasche	49,50	4	098320025	
20	Flasche		12	098322002	
50	Flasche		4	098322005	
250	Flasche		4	098322025	

9831L

Fügestoff-Niedrige Festigkeit

Ideal zum Blockieren kleine Teile und Teile, die einer regelmäßigen Wartung unterzogen werden müssen.
Erleichterter Ausbau der Teile.



Temperatur (°C)	-50/+150
Diametrales Spiel (mm)	0,10
Handfestigkeits-Aushärtezeit (minuten)	10/15
Funktionale Aushärtung (Stunden)	3-6
Viskosität (mPa.s) 25°C	500/800
Losbrechmoment ISO-10964	6-10 Nm
Weiterdrehmoment ISO-10964	4-8 Nm

ml		€			
20	Flasche	12,50	12	098310002	
50	Flasche	19,50	4	098310005	
250	Flasche	49,50	4	098310025	
20	Flasche		12	098312002	
50	Flasche		4	098312005	
250	Flasche		4	098312025	



9841N

Schwarzer essigsäurevernetzender Silikon-Dichtstoff, beständig gegen hohe Temperaturen,

mit praktischem Druckspender

Hält Temperaturen bis 240 °C.

Ermöglicht elastisches, dauerhaftes Abdichten. Ersetzt vorgeformte Dichtungen.

Der Spender ermöglicht eine einfache, genaue, gleichmäßige Verteilung des Produktes.

Polymerisiert durch die Reaktion auf die Luftfeuchtigkeit und bildet eine elastische, dauerhafte Dichtung.

Ideal für Ölwannen, Ölpumpen, Kürbelgehäuse, Getriebegehäuse, Motorteile, die keinem hohen Druck ausgesetzt sind, und Anwendungen, bei denen hohe Temperaturen erzeugt werden können. Haftet auf nicht porösen Substraten, wie z. B. Glas, lackiertes Holz, Keramik und Emailoberflächen. Nicht geeignet für PE, PP, PC, PMMA, PTFE, Weichkunststoff, Neopren- und Bitumenoberflächen. Nicht lackierbar.



ml	€	12	098410120
200	31,00	12	098410120
200		12	098412120

9841R

Roter essigsäurevernetzender Silikon-Dichtstoff, beständig gegen hohe Temperaturen,

mit praktischem Druckspender

Hält Temperaturen bis 300 °C.

Ermöglicht elastisches, dauerhaftes Abdichten. Ersetzt vorgeformte Dichtungen.

Der Spender ermöglicht eine einfache, genaue, gleichmäßige Verteilung des Produktes.

Polymerisiert durch die Reaktion auf die Luftfeuchtigkeit und bildet eine elastische, dauerhafte Dichtung.

Ideal für Ofentüren, Platten, Heizungsinstallationen, Abflussrohre, Thermostaten, Pumpen, Heizrohre, Motorteile, die keinem hohen Druck ausgesetzt sind, und Anwendungen, bei denen hohe Temperaturen erzeugt werden können. Haftet auf nichtporösen Substraten, wie z. B. Glas, lackiertes Holz, Keramik und Emailoberflächen. Nicht geeignet für PE, PP, PC, PMMA, PTFE, Weichkunststoff, Neopren- und Bitumenoberflächen.

Nicht lackierbar.



ml	€	12	098410020
200	29,50	12	098410020
200		12	098412020

9851

Sofortklebstoff für sekundenschnelle Strukturverbindungen

Auf Ethyl-Cyanacrylatbasis.

Ermöglicht das Anhaften auf einer breiten Auswahl von Materialien, wie Metall, Kunststoffe, Leder, Holz und viele andere Substratarten, auch in Kombination untereinander. Sehr schnelle Haftung.



Temperatur (°C)	-55/+82
Viskosität (mPa.s) 25 °C	80-120

g	€	12	098510500
5 Tube	6,50	12	098510500
20 Flasche	12,50	12	098510002
50 Flasche	24,50	10	098510005
5 Tube		12	098512500
20 Flasche		12	098512002
50 Flasche		10	098512005

9710 - LUBRIBETA universal

Mehrzwecklöser 7 in 1

1. Kriechfähig und lösend;
 2. Schmiermittel;
 3. Reinigung und Entfettung;
 4. Rostschutz;
 5. Desoxidierend für elektrische Kontakte;
 6. Wasserabstoßend;
 7. Gefrierschutz.
- Enthält kein Silikon.



ml	€	12	097100040
400	10,60	12	097100040
400		12	097101040
400		12	097102040



9712 - Ultra Sblock

Löse- und Superkriechmittel

Kriech- und Superpenetriertöl, desoxidierend und wasserabstoßend.

Ideal zum Lösen von Rost von Muttern, Bolzen, Schrauben und Zahnrädern.



ml	€	12	097120040
400	7,30	12	097120040
400		12	097121040
400		12	097122040

9720 - Multi Grease

Mehrzweckfett

Besonders geeignet zum Schmieren von Ketten, Zahnrädern/Getrieben und beweglichen Metallteilen.

Reib- und wetterfest. Hoch haftfähig.

Rinnt und tropft nicht.



ml	€	12	097200040
400	8,70	12	097200040
400		12	097201040
400		12	097202040

9722 - Lithium Grease

Weißes Lithiumfett

Auf der Basis von Lithium-Titan- und Zinkoxydseifenfetten. Ideal für Zahnräder/Getriebe, Lagern und Verbinder.

Spezifisch für Marineanwendungen. Stark wasserbeständig, salz- und wetterfest sowie beständig gegen hohe Temperaturen (bis zu 150 °C).

Rinnt und tropft nicht.



ml	€	12	097220040
400	10,00	12	097220040
400		12	097221040
400		12	097222040

9724 - PTFE Grease

Fett aus PTFE Basis

Besonders geeignet für das Schmieren von Industrieketten und mechanischen Bewegungen unter hohem Druck und nicht hohen Drehungen.

Geeignet für Anwendungen auf Kunststoff und Gummi.

Vollständig farblos. Wasserabweisend und oxidationsbeständig.



ml	€	🔧	📦
400	11,40	12	097240040
400		12	097241040
400		12	097242040

9726 - Copper Grease

Kupferfett

Für die Schmierung von Verbindern, Bolzen, Getrieben, Kurbelwellen und anderen Metallteilen, die hohen Temperaturen ausgesetzt sind (bis zu 1.000 °C).

Schutzwirkung und Verschleißschutz.

Verhütet Oxidation. Rinnt und tropft nicht.



ml	€	🔧	📦
400	13,40	12	097260040
400		12	097261040
400		12	097262040

9729 - Silic Spray

Silikonspray

Geeignet für die Schmierung von Kunststoff-, Gummi- und Metallteilen.

Schützt vor Korrosion. Formtrennmittel. Antistatisch.

Wasserabweisend. Poliermittel für Holz, Kunststoff und Gummi.

Enthält keine Lösemittel.



ml	€	🔧	📦
400	7,80	12	097290040
400		12	097291040
400		12	097292040

9738 - Cutting Oil

Schneidöl

Hohe Schmier- und Schutzkraft.

Geeignet zum Fräsen, Ausbohren, Gewindeschneiden, Bohren und Bearbeitung für manuelle und automatische Maschinen.

Hohe Oxidationsbeständigkeit.

Waschbar mit Wasser. Enthält keine Lösemittel.



ml	€	🔧	📦
400	8,40	12	097380040
400		12	097381040
400		12	097382040

9740 - Brake Cleaner

Bremsenreinigungsmittel

Ideal für die Reinigung von Brems Scheiben und Bremsbelag, Motoren.

Entfernt Fett und Teer, ohne Rückstände zu hinterlassen.

Schnell verdunstend. Greift Gummi und Kunststoff nicht an.



ml	€	🔧	📦
500	7,60	12	097400050
500		12	097401050
500		12	097402050

9741 - Multi Cleaner

Mehrzweckreiniger- und entfetter

Reinigungs- und Entfettungsmittel zum Lösen von Fett, Öl, Teer, Silikon und Kleber.

Geeignet für die Reinigung von Oberflächen aus Metall, starrem Kunststoff, Keramik, Stahl und Aluminium.

Hinterlässt keine ölhaltigen Rückstände.



ml	€	🔧	📦
400	8,20	12	097410040
400		12	097411040
400		12	097412040

9742 - Contact Cleaner

Reinigungsmittel für elektrische und elektronische Kontakte

Entfernt Fett und Schmutz, ohne Ölrückstände zu hinterlassen.

Schnellverdunstend. Greift Gummi und Kunststoff nicht an.



ml	€	🔧	📦
400	7,90	12	097420040
400		12	097421040
400		12	097422040

9743 - SURFACE CLEANER

Reinigungsschaum

Reinigungsschaum für alle Oberflächen, Werkzeuge und Gewebe.

Auf der Basis von quaternären Ammoniumsalzen hergestellt. Bildet einen aktiven Schaum, der reinigt und Schmutz und Fett entfernt.

Neutralisiert üble Gerüche. Kein Abspülen erforderlich. Kein Desinfektionsmittel.



ml	€	🔧	📦
500	16,00	12	097430050
500		12	097431050
500		12	097432050

9745 - Carb Cleaner

Reinigungsmittel für Vergaser und Drosselklappengehäuse

Spezifisch für die Innen- und Außenreinigung von Vergasern, Saugrohren und Drosselklappengehäusen.

Entfernt vollständig kohlehaltige Rückstände, Ablagerungen und Unreinheiten.

Hinterlässt keine Ölrückstände.



ml	€	🔧	📦
400	8,50	12	097450040
400		12	097451040
400		12	097452040

9746 - Klima Cleaner

Reinigungsmittel für Klimaanlage

Reinigungsmittel für Klimaanlage und Luftkonditionierer für Industrie-, Zivil- und Fahrzeugsysteme. Aufgrund seiner Schaum-Formulierung und des mitgelieferten Röhrchens ermöglicht es die Beseitigung von Schmutz, Verkrustungen und Gerüchen in den Luftkanälen und hinterlässt einen angenehmen Duft.



ml	€		
400	13,80	12	097460040
400		12	097461040
400		12	097462040

9749 - Air Spray

Luftspray

Aerosol auf Druckgasbasis. Ideal zum Beseitigen von Staubablagerungen in den Schlitzen und Spalten, Zahnradern, elektrischen Komponenten, Tastaturen und empfindlichen Mechanismen im Allgemeinen. Das Abgaberröhrchen ermöglicht, auch tiefliegende, schlecht zugängliche Teile zu erreichen.



ml	€		
400	8,80	12	097490040
400		12	097491040
400		12	097492040

9752 - Zinc 98%

Klarzink

Mit hohem Deckvermögen ist dieses Mittel ideal zum Verzinken von Eisenteilen. Stark haftfähig durch einen elastischen, sehr hellen Film, der ähnlich der Heißverzinkung ist. Besonders beständig gegen Oxidation, abrieb- und wetterfest. Kann überlackiert werden. Rinnt und trocknet nicht.



ml	€		
400	9,70	12	097520040
400		12	097521040
400		12	097522040

9755 - Welding Spray

Schweißtrennmittel

Silikonfreies Schweißtrennmittel. Vermeidet das Anhaften von Schweißspritzern und Schweißperlen und erleichtert so den Schweißvorgang. Zu verwenden auf zu schweißenden Teilen und als Schutz für die Schweißbrennerdüsen. Ermöglicht darauffolgende Bearbeitungen wie Lackierung, Verzinkung und Verchromung. Entwickelt keinen Rauch. Leicht entfernbar. Enthält keine chlorhaltigen Stoffe.



ml	€		
400	8,70	12	097550040
400		12	097551040
400		12	097552040

9765 - Deicer Spray

Enteiserspray

Enteiser- und Entfrosterspray, zum Entfernen von Eis und Frost auf Glas und Scheiben. Ideal auch für Schlösser und Mechanismen, die vereist sind. Wirkt bis zu -40 °C. Fettig nicht und hinterlässt keine Ränder. Greift die behandelten Oberflächen, Gummi und Kunststoff nicht an.



ml	€		
400	14,50	12	097650040
400		12	097651040
400		12	097652040

9775 - Water Stop

Imprägniermittel für Textilien

Imprägnierendes und wasserabstoßendes Mittel für Textilien und Leder. Ideal für Schuhe, Jacken und Kleidung im Allgemeinen. Ermöglicht das Imprägnieren von Textilien, ohne deren Atmungsaktivität zu beeinträchtigen. Durch die schmutzabweisende Wirkung wird das Waschen der Textilien leichter gemacht. Verbessert die Knick- und Abriebfestigkeit.



ml	€		
400	15,60	12	097750040
400		12	097751040
400		12	097752040

9881U

Alkalischer Industriereiniger für Ultraschallwanne

Alkalischer Industriereiniger, Konzentrat, auf Wasserbasis. Für Ultraschallreinigung und andere Aufbereitungsverfahren. Zur sorgfältigen, wirksamen Reinigung der Ersatzteile und Metallteile im Allgemeinen (Injektoren, Vergaser, Ventile usw.). Entfernt Öle, Fette, Schmiermittel, Kleberrückstände, Harze, Wachs. Auch zur Reinigung von Aluminiumteilen geeignet.



Lt	€		
1	40,00	1	098810010
1		1	098812010

9882R

Selektive Ablösung von Rost

Selektiver Rostlöser auf Wasserbasis für Eisen, Stahl, Edelstahl, Gusseisen und Chromierungen. Entfernt ausschließlich die oxidierte Schicht, ohne das Metallsubstrat zu beschädigen. Verdünnung: von rein bis max. 1:1. Minimale Betriebstemperatur: 15 °C. Betriebszeiten: 30' - 24/48h (für dicke Rostschichten). Biologisch abbaubar und 100% wasserlöslich.



Lt	€		
1	48,50	1	098820010
1		1	098822010



Eine komplette Produktpalette von starren und flexiblen Schleifmitteln, bestehend aus mehr als 500 vollständig in Italien hergestellten Referenzen. Entstanden und entwickelt, um alle Industrie- und Berufsansprüche hinsichtlich Schneiden oder Materialabtrag zu erfüllen.

Mit dem Projekt "Beta Abrasives" bekräftigt Beta Utensili die feste Absicht des Unternehmens, den im Fachbereich tätigen Kräften eine umfassende Produktpalette und einen herausragenden, durch Kompetenz gekennzeichneten Service anzubieten, welcher auch durch den Beitrag der AbraBeta-Produkte garantiert wird.



STARRE SCHLEIFSCHEIBEN ZUM SCHNEIDEN UND ENTGRATEN

Die starren Schleifscheiben stellen die wichtigste Kategorie der neuen Produktfamilie dar. Daher lässt Beta Utensili der Auswahl der eingesetzten Werkstoffe und der jeweils angewandten Typologien größtmögliche Beachtung zukommen. Die Scheiben zum Schneiden und Entgraten sind die schnellsten und vielseitigsten Arbeitsmittel zur Bearbeitung der verschiedensten Werkstoffe, welche über spezifisch konzipierte Werkzeuge wie Winkelschleifer oder stationäre Maschinen ermöglicht wird.

FORMEN der Schleifscheiben

 **T42**
Gekröpfte Trennschleifscheibe

 **T41**
Flache Trennschleifscheibe

 **T27**
Gekröpfte Schruppscheibe



Für kompromisslose Qualität und extrem anspruchsvolle Anwender.



Hohe Qualität und optimale Leistungen bei ausgesprochen günstigem Verhältnis zwischen Qualität und Preis.

ZERTIFIKATIONEN



PIKTOGRAMME auf den Schleifscheiben



Schutzbrille anlegen



Schutzhandschuhe anlegen



Gehörschutz anlegen



Schutzkleidung anlegen



Staubmaske anlegen



Siehe Gebrauchsanleitungen



Scheibe nur zum Trennen geeignet – nicht zum Entgraten verwenden



Keine beschädigten Scheiben verwenden



Eisen-, Schwefel- und Chlorfrei ($\leq 0,1\%$)

Anwendungszeitraum

Der Zeitraum der max. Anwendung beläuft sich auf 3 Jahre ab dem Datum der Herstellung. Der auf der metallischen Unterlegscheibe in der Mitte der Scheibe eingravierte Schriftzug "V01" zeigt das Verfallsdatum (Quartal) an. Beispiel: Der Schriftzug "V07/2022" zeigt an, dass die Scheibe im 3. Quartal 2019 produziert wurde und bis Ende des 3. Quartals 2022 verwendet werden kann.

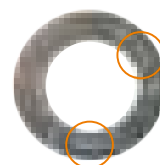

	Quartal
V01	Jan-März
V04	Apr-Juni
V07	Juli-Sept
V10	Okt-Dez



SCHLEIFSTIFTE

Schleifstifte zur Anwendung mit Einhandstabschleifern, in verschiedenen Formen zur optimalen Anpassung an die Anforderungen der Bearbeitung; mit drei verschiedenen Schleifmitteln.



SCHLEIFFÄCHER MIT SCHAFT

Die Schleiffächer mit Schaft haben flexible Lamellen für den präzisen und gleichförmigen Feinschliff bei unregelmäßigen Formen und Oberflächen.



LAMELLEN-SCHLEIFSCHEIBEIN

Die Lamellen-Schleifscheiben bestehen aus Lamellen aus Schleifsteinen, die auf einen Stützteller aufgeklebt sind. Sie sind ein optimales Arbeitsmittel zum Schruppen und Feinschleifen. Im Allgemeinen garantieren sie im Vergleich zu Schruppscheiben eine schnellere Abtragung, ein gleichartiges Bild des Feinschliffs, weniger Vibrationen und Lärmreduzierung bei niedrigeren Arbeitstemperaturen. Sie werden mit Schleifsteinen aus verschiedenen Materialien und mit unterschiedlicher Körnung sowie mit zwei verschiedenen Stütztellern angeboten.

Ausführungen



Flache Form

Max. Schleifwinkel 15 Grad zur Arbeitsfläche, zur Bearbeitung von ebenen Flächen und Kanten.



Schräge Form

Vereinfachung der Bearbeitung auf beschädigten Oberflächen, Schleifwinkel zwischen 15 und 25 Grad zur Arbeitsfläche. Größere Kontaktfläche zwischen Scheibe und Arbeitsfläche. Die Lamellen können so lange verwendet werden, bis sie vollständig abgenutzt sind.



Für kompromisslose Qualität und extrem anspruchsvolle Anwender.



Hohe Qualität und optimale Leistungen bei ausgesprochen günstigem Verhältnis zwischen Qualität und Preis.



SCHLEIFFÄCHER MIT BOHRUNG

Dank der Flexibilität der Lamellen eignen sich die Schleiffächer mit Flansch Aufnahme bestens zur Bearbeitung von unregelmäßigen Flächen, Kanten und Rahmen.



SCHLEIFFÄCHER FÜR SATINIERMASCHINEN

Die Schleiffächer für Beta-Satiniermaschinen sind die bestdenkbare Lösung zum Satinieren gleich welcher Materialien.

Körnung / Finishing	
C	Grob (Coarse)
M	Mittel (Medium)
F	Fein (Fine)
VF	Sehr fein (Very Fine)
UF	Ultra fein (Ultra Fine)



RADIAL- UND FIBERSCHLEIFSCHEIBEN

Spezialschleifscheiben mit Vlieslamellen für hohe Polierleistung bei schneller und genauer Bearbeitung.



SPARROLLEN

Ein breites Angebot an Sparrollen mit Schleifsteinen, Schleifpapier und Schleifvlies, alle der besten Qualität und für die verschiedensten Arten der Bearbeitung geeignet.

Weitere Informationen finden Sie in dem entsprechenden Katalog, der auf dem Beta Website unter www.beta-tools.com verfügbar ist.

11001
Trennschleifscheiben für Stahl
Ausführung gekröpft

A30S EN 12413



A30S



	Ø mm	S mm	F mm	max. rpm	€	10	110010118
11001	115	3,2	22,23	13300	2,20	10	110010118
11001	125	3,2	22,23	12200	2,40	10	110010128
11001	230	3,2	22,23	6600	5,00	10	110010233

11001H
Trennschleifscheiben für Stahl
Ausführung gekröpft

HARD

A30T EN 12413



A30T

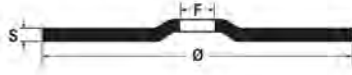

	Ø mm	S mm	F mm	max. rpm	€	10	110010733
11001H	230	3,2	22,23	6600	5,00	10	110010733

11003
Trennschleifscheiben für Stahl
Ausführung gerade

A30T EN 12413



A30T

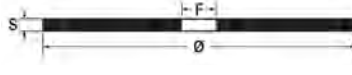

	Ø mm	S mm	F mm	max. rpm	€	10	110030117
11003	115	2,5	22,23	13300	2,20	10	110030117
11003	125	2,5	22,23	12200	2,10	10	110030127
11003	180	2,5	22,23	8500	4,30	10	110030182
11003	230	2,5	22,23	6600	4,60	10	110030232

11011
Schruppscheiben für Stahl
Ausführung gekröpft

A24N EN 12413



A24N



	Ø mm	S mm	F mm	max. rpm	€	10	110110115
11011	115	6,5	22,23	13300	3,00	10	110110115
11011	125	6,5	22,23	12200	3,30	10	110110125
11011	180	6,5	22,23	8500	6,10	10	110110180
11011	230	6,5	22,23	6600	8,90	10	110110230

11011H
Trennschleifscheiben für Stahl
Ausführung gekröpft

HARD

A24R EN 12413



A24R



	Ø mm	S mm	F mm	max. rpm	€	10	110110615
11011H	115	6,5	22,23	13300	3,10	10	110110615
11011H	125	6,5	22,23	12200	3,30	10	110110625
11011H	180	6,5	22,23	8500	6,10	10	110110680
11011H	230	6,5	22,23	6600	8,90	10	110110730

11018
Trennschleifscheiben zum Trennen von Stahl
Ausführung gerade

60 m/s

A46N EN 12413



A46N



	Ø mm	S mm	F mm	max. rpm	€	10	110180030
11018	300	2,5	25,40	4010	7,90	10	110180030
11018	350	3,0	25,40	3440	12,30	10	110180035
11018	400	3,2	25,40	3010	15,80	10	110180040

11019

Trennschleifscheiben zum Trennen von Stahl
Ausführung gerade

80 m/s

A24N EN 12413



A24N



	Ø mm	S mm	F mm	max. rpm	€		
11019	300	3,8	25,40	5100	9,70	10	110190030
11019	350	4,2	25,40	4400	14,50	10	110190035
11019	400	4,5	25,40	3800	18,90	10	110190040

11021

Trennschleifscheiben für Stahl und Inox
Ausführung gekröpft

A30Q EN 12413



A30Q



	Ø mm	S mm	F mm	max. rpm	€		
11021	115	3,2	22,23	13300	2,20	10	110210118
11021	125	3,2	22,23	12200	2,30	10	110210128
11021	180	3,2	22,23	8500	4,30	10	110210183
11021	230	3,2	22,23	6600	4,90	10	110210233

11023

Schruppscheiben für Stahl und Inox
Ausführung gekröpft

A24Q EN 12413



A24Q

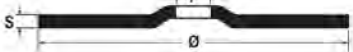

	Ø mm	S mm	F mm	max. rpm	€		
11023	115	6,5	22,23	13300	3,00	10	110230115
11023	125	6,5	22,23	12200	3,30	10	110230125
11023	230	6,5	22,23	6600	8,90	10	110230230

11024

Trennschleifscheiben für Stahl und Inox
Ausführung Dünnschicht und gekröpft

TOP LINE

A46U EN 12413



A46U

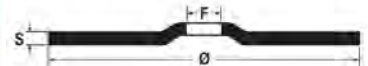

	Ø mm	S mm	F mm	max. rpm	€		
11024	230	2,0	22,23	6600	6,20	10	110240230

11031÷11038

Trennschleifscheiben für Stahl und Inox
Ausführung Dünnschicht und gerade

TOP LINE

Ø 65 mm

A46U EN 12413



A46U



	Ø mm	S mm	F mm	max. rpm	€		
11031	65	1,0	6,00	24000	1,90	25	110310006
11031	65	1,0	10,00	24000	1,90	25	110310010
11031	65	1,6	10,00	24000	1,90	25	110310020

	Ø mm	S mm	F mm	max. rpm	€		
11032	76	1,0	6,00	20200	1,90	25	110320006
11032	76	1,0	10,00	20200	1,90	25	110320010
11032	76	1,6	10,00	20200	1,90	25	110320020

	Ø mm	S mm	F mm	max. rpm	€		
11034	115	1,0	22,23	13300	2,90	25	110340022
11034	115	1,2	22,23	13300	2,90	25	110340042
11034	115	1,6	22,23	13300	2,90	25	110340062

	Ø mm	S mm	F mm	max. rpm	€		
11035	125	1,0	22,23	12200	3,00	25	110350022
11035	125	1,2	22,23	12200	3,00	25	110350042
11035	125	1,6	22,23	12200	3,00	25	110350062

	Ø mm	S mm	F mm	max. rpm	€		
11037	180	2,0	22,23	8500	4,90	10	110370022

	Ø mm	S mm	F mm	max. rpm	€		
11038	230	2,0	22,23	6600	5,70	10	110380022

11040

Trennschleifscheiben für Stahl und Inox
Ausführung Dünnschicht und gekröpft

PREMIUM LINE

A36Q EN 12413



	Ø mm	S mm	F mm	max. rpm	€		
11040	230	2,0	22,23	6600	4,60	10	110400230

11045-11046

Trennschleifscheiben für Stahl und Inox
Ausführung Dünnschicht und gerade

PREMIUM LINE

Ø 115 mm

A46Q EN 12413



	Ø mm	S mm	F mm	max. rpm	€		
11045	115	1,0	22,23	13300	2,20	25	110450010
11045	115	1,2	22,23	13300	2,20	25	110450012
11045	115	1,6	22,23	13300	2,20	25	110450016

	Ø mm	S mm	F mm	max. rpm	€		
11046	125	1,0	22,23	12200	2,40	25	110460010
11046	125	1,2	22,23	12200	2,40	25	110460012
11046	125	1,6	22,23	12200	2,40	25	110460016

11048-11049

Trennschleifscheiben für Stahl und Inox
Ausführung Dünnschicht und gerade

Ø 180 mm

A36Q EN 12413

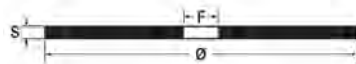

	Ø mm	S mm	F mm	max. rpm	€		
11048	180	2,0	22,23	8500	3,30	10	110480019

	Ø mm	S mm	F mm	max. rpm	€		
11049	230	2,0	22,23	6600	4,40	10	110490019

11050

Schruppscheiben für Stahl
Zirkon-Ausführung gekröpft

ZA24R - EN 12413

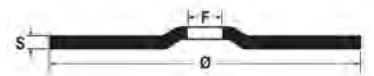

	Ø mm	S mm	F mm	max. rpm	€		
11050	115	6,5	22,23	13300	4,90	10	110500115
11050	125	6,5	22,23	12200	5,90	10	110500125
11050	230	7,0	22,23	6600	14,70	10	110500230

11069

Trennschleifscheiben für Stein und Marmor
Ausführung gekröpft

C30S EN 12413

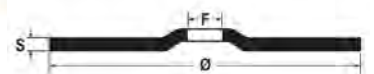

	Ø mm	S mm	F mm	max. rpm	€		
11069	115	3,2	22,23	13300	2,40	10	110690115
11069	125	3,2	22,23	12200	2,40	10	110690125
11069	230	3,2	22,23	6600	5,40	10	110690230



11100
Schleifstifte
Schleifkörner Korund rosa
Zylinderstift

Schaft Ø 3 x 37 mm
EN 12413

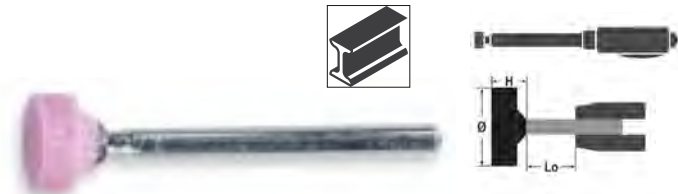

	Ø mm	h mm	max. rpm Lo=13 mm		€		
11100	4	8	130.000	AR60P5V	1,20	25	111000004
11100	6	10	93.100	AR60P5V	1,20	25	111000006
11100	8	12	64.500	AR60P5V	1,20	25	111000008
11100	10	10	60.100	AR60P5V	1,20	25	111000011
11100	10	12	52.700	AR60P5V	1,20	25	111000012
11100	12	15	37.300	AR60P5V	1,50	25	111000013

11101
Schleifstifte
Schleifkörner Korund rosa
Zylinderstift

Schaft Ø 6 x 40 mm
EN 12413

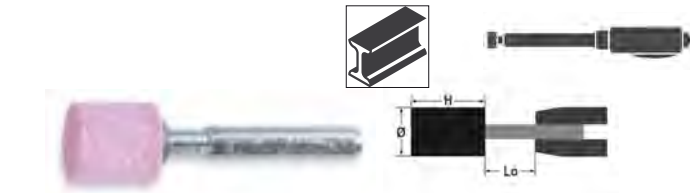

	Ø mm	h mm	max. rpm Lo=13 mm		€		
11101	4	8	130.000	AR60P5V	1,50	25	111010004
11101	5	10	130.000	AR60P5V	1,50	25	111010005
11101	6	10	130.000	AR60P5V	1,50	25	111010006
11101	8	10	119.300	AR60P5V	1,50	25	111010008
11101	10	10	95.400	AR60P5V	1,50	25	111010010
11101	10	15	95.400	AR60P5V	1,50	25	111010011
11101	10	20	86.600	AR60P5V	1,60	25	111010012
11101	10	25	72.700	AR60P5V	1,80	25	111010013
11101	10	32	58.700	AR60P5V	1,90	25	111010014
11101	12	10	79.500	AR60P5V	1,40	25	111010015
11101	12	15	79.500	AR60P5V	1,50	25	111010016
11101	12	20	79.500	AR60P5V	1,50	25	111010017
11101	15	3	63.600	AR60P5V	1,40	25	111010018
11101	15	15	63.600	AR60P5V	1,50	25	111010019
11101	16	20	59.600	AR46P5V	1,70	25	111010020
11101	16	25	56.900	AR46P5V	1,80	25	111010021
11101	16	32	45.100	AR46P5V	2,00	25	111010022
11101	20	4	47.700	AR60P5V	1,40	25	111010023
11101	20	15	47.700	AR46P5V	1,50	25	111010024
11101	20	20	47.700	AR46P5V	1,80	25	111010025
11101	20	25	46.100	AR46P5V	1,90	25	111010026
11101	20	30	38.900	AR46P5V	2,00	25	111010027
11101	20	40	29.000	AR46P5V	2,60	25	111010028
11101	25	10	38.100	AR60P5V	1,50	25	111010030
11101	25	25	37.200	AR36/46P5V	2,00	25	111010031
11101	25	40	23.300	AR36/46P5V	3,00	10	111010032
11101	30	10	31.800	AR60P5V	1,70	25	111010034
11101	30	30	26.200	AR36/46P5V	2,40	25	111010035
11101	30	40	19.500	AR36/46P5V	3,30	10	111010036
11101	32	20	29.800	AR36P5V	2,30	25	111010037
11101	32	32	23.100	AR36P5V	3,10	10	111010038
11101	40	10	23.800	AR36/46P5V	2,40	25	111010041
11101	40	20	23.800	AR36P5V	3,30	10	111010042
11101	40	25	23.400	AR36P5V	3,40	10	111010043
11101	40	30	19.700	AR36P5V	3,60	10	111010044
11101	40	40	14.700	AR36P5V	4,40	10	111010045
11101	50	15	19.000	AR36P5V	3,70	10	111010051
11101	50	25	18.800	AR36P5V	4,20	10	111010052
11101	60	10	15.900	AR36P5V	3,80	10	111010060

11102
Schleifstifte
Schleifkörner Korund rosa
Zylinderstift

Schaft Ø 6 x 80 mm
EN 12413

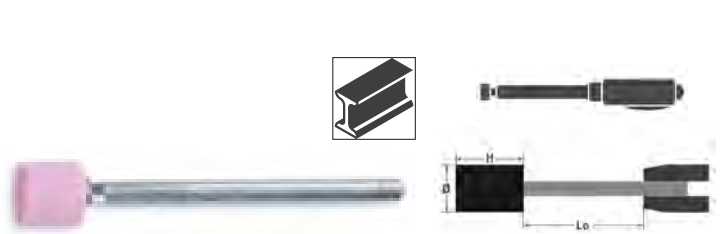

	Ø mm	h mm	max. rpm Lo=13 mm		€		
11102	8	20	100.500	AR60P5V	1,90	25	111020008
11102	10	15	95.400	AR60P5V	1,80	25	111020010
11102	10	30	62.200	AR60P5V	2,20	25	111020020
11102	12	15	79.500	AR60P5V	1,90	25	111020022
11102	15	15	63.600	AR60P5V	2,10	25	111020035
11102	15	30	51.000	AR46P5V	2,40	25	111020040
11102	20	30	38.900	AR46P5V	2,50	25	111020060

11105
Schleifstifte
Schleifkörner Korund rosa Zylinderstift dreieckig

Schaft Ø 6 x 40 mm
EN 12413

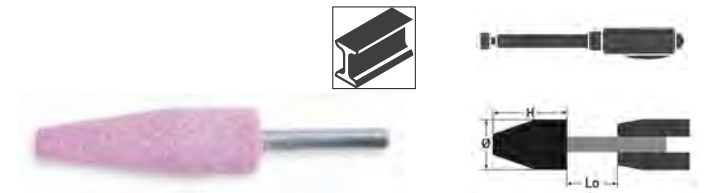

	Ø mm	h mm	max. rpm Lo=13 mm		€		
11105	20	65	16.200	AR36/46P5V	4,60	25	111050020

11106
Schleifstifte
Schleifkörner Korund rosa
Trapezform

Schaft Ø 3 x 37 mm
EN 12413

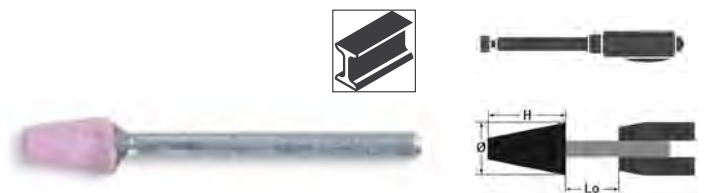

	Ø mm	h mm	max. rpm Lo=13 mm		€		
11106	6	10	93.100	AR60P5V	1,70	25	111060006

11107
Schleifstifte
Schleifkörner Korund rosa
Trapezform

Schaft Ø 6 x 40 mm
EN 12413

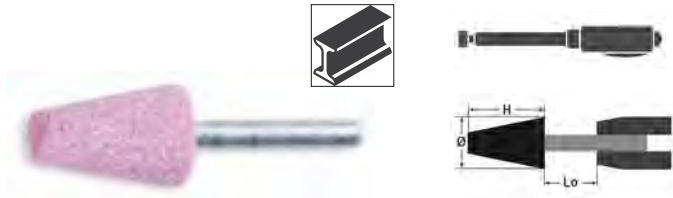

	Ø mm	h mm	max. rpm Lo=13 mm		€		
11107	12	20	79.500	AR60P5V	1,90	25	111070012
11107	15	25	60.400	AR46P5V	2,20	25	111070015
11107	20	30	38.900	AR46P5V	2,60	25	111070020
11107	25	40	23.300	AR36/46P5V	3,60	10	111070025

11110
Schleifstifte
Schleifkörner Korund rosa
Kegelstift

Schaft Ø 3 x 37 mm
EN 12413



	Ø mm	h mm	max. rpm Lo=13 mm		€		
11110	10	15	44.300	AR60P5V	1,70	25	111100010

11111
Schleifstifte
Schleifkörner Korund rosa
Kegelstift

Schaft Ø 6 x 40 mm
EN 12413



	Ø mm	h mm	max. rpm Lo=13 mm		€		
11111	10	20	86.600	AR60P5V	1,90	25	111110010
11111	15	30	51.000	AR46P5V	2,50	25	111110015
11111	16	45	31.400	AR46P5V	3,40	25	111110016
11111	20	28	41.500	AR46P5V	2,60	25	111110020
11111	20	40	29.000	AR46P5V	3,30	25	111110021
11111	30	50	15.100	AR36/46P5V	4,60	10	111110030

11115
Schleifstifte
Schleifkörner Korund rosa
Spitzbogenstift

Schaft Ø 3 x 37 mm
EN 12413

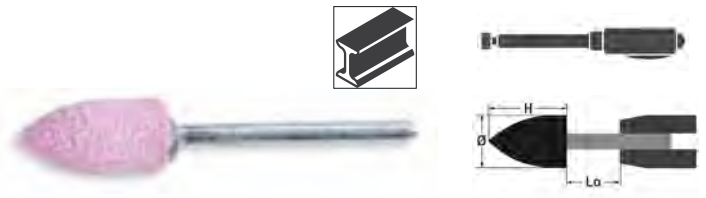

	Ø mm	h mm	max. rpm Lo=13 mm		€		
11115	10	20	34.700	AR60P5V	1,80	25	111150010

11116
Schleifstifte
Schleifkörner Korund rosa
Spitzbogenstift

Schaft Ø 6 x 40 mm
EN 12413

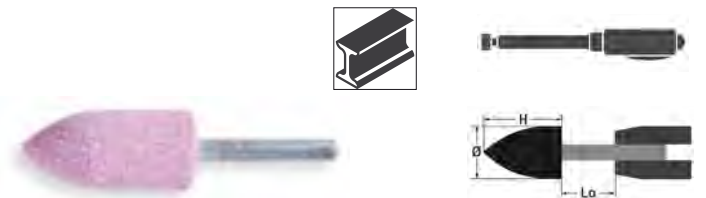

	Ø mm	h mm	max. rpm Lo=13 mm		€		
11116	10	20	86.600	AR60P5V	1,90	25	111160010
11116	18	30	43.000	AR46P5V	2,60	25	111160018
11116	20	50	22.500	AR36/46P5V	3,80	25	111160020
11116	22	70	13.400	AR36/46P5V	5,80	10	111160022

11120
Schleifstifte
Schleifkörner Korund rosa
Zylinderform Pyramide

Schaft Ø 3 x 37 mm
EN 12413

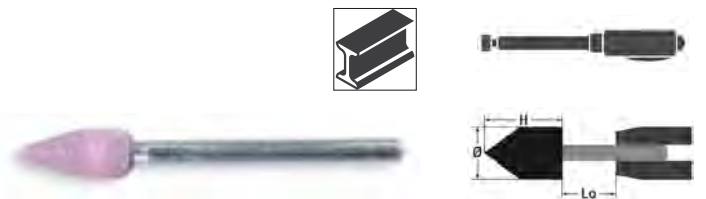

	Ø mm	h mm	max. rpm Lo=13 mm		€		
11120	6	13	77.800	AR60P5V	1,70	25	111200006



11121
 Schleifstifte
 Schleifkörner Korund rosa
 Zylinderform Pyramide
 Schaft Ø 6 x 40 mm
 EN 12413

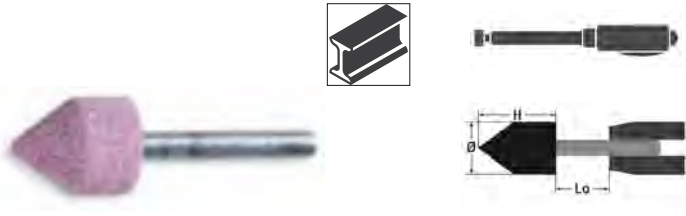

	Ø mm	h mm	max. rpm Lo=13 mm		€		
11121	6	25	100.700	AR60P5V	2,60	25	111210007
11121	12	20	79.500	AR60P5V	1,90	25	111210012
11121	20	25	46.100	AR46P5V	2,30	25	111210020
11121	25	25	37.200	AR36/46P5V	2,60	25	111210025
11121	30	30	26.200	AR36/46P5V	3,00	25	111210030

11125
 Schleifstifte
 Schleifkörner Korund rosa
 Walzenrundstift
 Schaft Ø 6 x 40 mm
 EN 12413



	Ø mm	h mm	max. rpm Lo=13 mm		€		
11125	6	20	117.700	AR60P5V	2,10	25	111250006
11125	25	25	37.200	AR36/46P5V	2,60	25	111250025
11125	30	50	15.100	AR36/46P5V	4,60	10	111250030
11125	40	40	14.700	AR36P5V	5,60	10	111250040

11130
 Schleifstifte
 Schleifkörner Korund rosa
 Kugelstift
 Schaft Ø 3 x 37 mm
 EN 12413



	Ø mm	h mm	max. rpm Lo=13 mm		€		
11130	6	6	124.900	AR60P5V	1,70	25	111300006
11130	8	8	84.800	AR60P5V	1,70	25	111300008
11130	10	10	60.100	AR60P5V	1,70	25	111300010

11131
 Schleifstifte
 Schleifkörner Korund rosa
 Kugelstift
 Schaft Ø 6 x 40 mm
 EN 12413

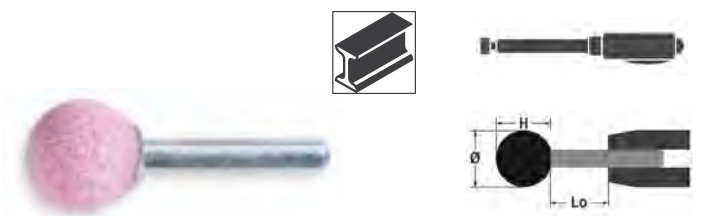

	Ø mm	h mm	max. rpm Lo=13 mm		€		
11131	10	10	95.400	AR60P5V	1,80	25	111310010
11131	15	15	63.600	AR60P5V	1,90	25	111310015
11131	20	20	47.700	AR46P5V	2,20	25	111310020
11131	25	25	37.200	AR36/46P5V	2,60	25	111310025
11131	30	30	26.200	AR36/46P5V	3,00	25	111310030

11132
 Schleifstifte
 Schleifkörner Korund rosa
 Kugelstift
 Schaft Ø 6 x 80 mm
 EN 12413

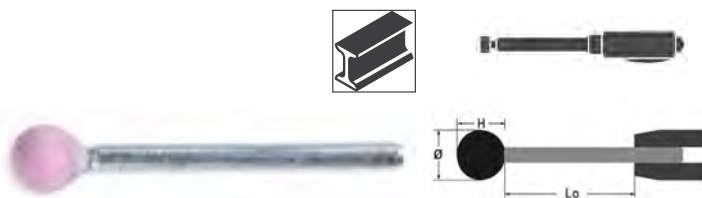

	Ø mm	h mm	max. rpm Lo=13 mm		€		
11132	10	10	95.400	AR60P5V	2,10	25	111320010
11132	15	15	63.600	AR60P5V	2,30	25	111320015
11132	20	20	47.700	AR46P5V	2,70	25	111320020

11135
 Schleifstifte
 Schleifkörner Korund rosa
 Scheibenstift
 Schaft Ø 6 x 40 mm
 EN 12413

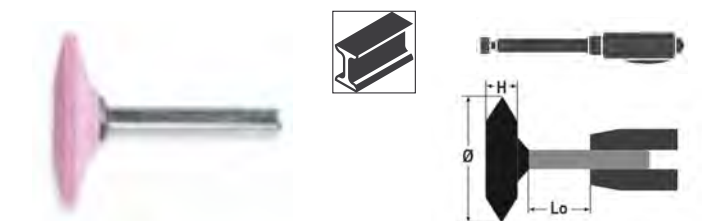

	Ø mm	h mm	max. rpm Lo=13 mm		€		
11135	30	6	31.800	AR60P5V	2,10	25	111350030
11135	40	10	23.800	AR36/46P5V	3,10	25	111350040

11140

Schleifstifte
Schleifkörner Korund grau/rosa
Zylinderstift

Schaft Ø 6 x 40 mm

EN 12413

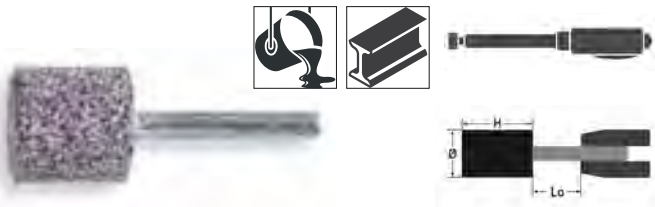

Ø mm	h mm	max. rpm Lo=13 mm		€		
11140	20	30	38.900	A/AR24R5V	2,10	25 111400020
11140	25	25	37.200	A/AR24R5V	2,10	25 111400025
11140	30	30	26.200	A/AR24R5V	2,40	25 111400030
11140	50	10	19.000	A/AR24R5V	3,30	10 111400050

11141

Schleifstifte
Schleifkörner Korund grau/rosa
Zylinderstift

Schaft Ø 6 x 80 mm

EN 12413

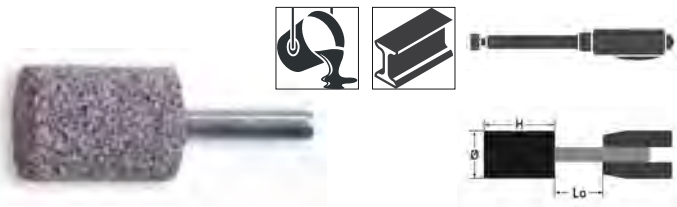

Ø mm	h mm	max. rpm Lo=13 mm		€		
11141	20	40	46.800	A/AR24R5V	2,90	25 111410020
11141	30	40	31.800	A/AR24R5V	3,40	10 111410030
11141	40	40	23.800	A/AR24R5V	4,90	10 111410040

11145

Schleifstifte
Schleifkörner Korund grau/rosa
Spitzbogenstift

Schaft Ø 6 x 40 mm

EN 12413

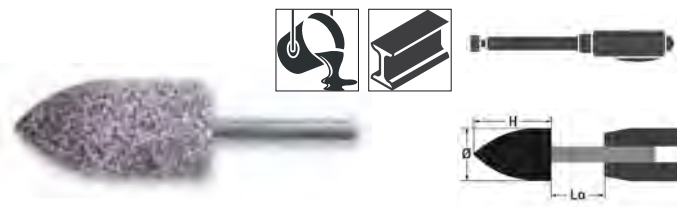

Ø mm	h mm	max. rpm Lo=13 mm		€		
11145	20	30	38.900	A/AR24R5V	2,60	25 111450020
11145	25	50	18.100	A/AR24R5V	4,40	10 111450025

11200A-11200B

Lamellenscheiben Zirkon Fächerschleifscheibe
Trägermaterial aus Kunststoff und Einzellamelle

Ausführung gerade

PREMIUM LINE

Ø 115 mm

EN 13743



Ø mm	P mm	F mm	€		
11200A	115	40	22,23	3,50	10 112000004
11200A	115	60	22,23	3,50	10 112000006
11200A	115	80	22,23	3,50	10 112000008
11200A	115	120	22,23	3,50	10 112000012

Ø mm	P mm	F mm	€		
11200B	125	40	22,23	4,30	10 112000104
11200B	125	60	22,23	4,30	10 112000106
11200B	125	80	22,23	4,30	10 112000108

11202A÷11202C

Lamellenscheiben Zirkon Fächerschleifscheibe
Trägermaterial Kunststoff und Doppellamelle

Ausführung gerade

PREMIUM LINE

Ø 115 mm

EN 13743



Ø mm	P mm	F mm	€		
11202A	115	40	22,23	3,50	10 112020004
11202A	115	60	22,23	3,50	10 112020006
11202A	115	80	22,23	3,50	10 112020008
11202A	115	120	22,23	3,50	10 112020012

Ø mm	P mm	F mm	€		
11202B	125	40	22,23	4,30	10 112020104
11202B	125	60	22,23	4,30	10 112020106
11202B	125	80	22,23	4,30	10 112020108

Ø mm	P mm	F mm	€		
11202C	180	40	22,23	9,00	10 112020204
11202C	180	60	22,23	9,00	10 112020206

11204A-11204B

Lamellenscheiben Zirkon Fächerschleifscheibe
Trägermaterial Glasfaser und Einzellamelle

Ausführung gerade
PREMIUM LINE
Ø 115 mm
EN 13743



	Ø mm	P	F mm	€		
11204A	115	40	22,23	3,50	10	112040004
11204A	115	60	22,23	3,50	10	112040006
11204A	115	80	22,23	3,50	10	112040008
11204A	115	120	22,23	3,50	10	112040012
<hr/>						
	Ø mm	P	F mm	€		
11204B	125	40	22,23	4,30	10	112040104
11204B	125	60	22,23	4,30	10	112040106
11204B	125	80	22,23	4,30	10	112040108

11208A-11208B

Lamellenscheiben Zirkon Fächerschleifscheibe
Trägermaterial Glasfaser und Doppellamelle

Ausführung gerade
PREMIUM LINE
Ø 115 mm
EN 13743



	Ø mm	P	F mm	€		
11208A	115	40	22,23	3,50	10	112080004
11208A	115	60	22,23	3,50	10	112080006
<hr/>						
	Ø mm	P	F mm	€		
11208B	125	40	22,23	4,30	10	112080104
11208B	125	60	22,23	4,30	10	112080106

11210A-11210B

Lamellenscheiben Zirkon Fächerschleifscheibe
Trägermaterial Glasfaser und Einzellamelle

Ausführung konisch
PREMIUM LINE
Ø 115 mm
EN 13743



	Ø mm	P	F mm	€		
11210A	115	40	22,23	3,50	10	112100004
11210A	115	60	22,23	3,50	10	112100006
11210A	115	80	22,23	3,50	10	112100008
11210A	115	120	22,23	3,50	10	112100012
<hr/>						
	Ø mm	P	F mm	€		
11210B	125	40	22,23	4,30	10	112100104
11210B	125	60	22,23	4,30	10	112100106
11210B	125	80	22,23	4,30	10	112100108

11212A-11212B

Lamellenscheiben Zirkon Fächerschleifscheibe
Trägermaterial Kunststoff und Einzellamelle

Ausführung gerade
TOP LINE
Ø 115 mm
EN 13743

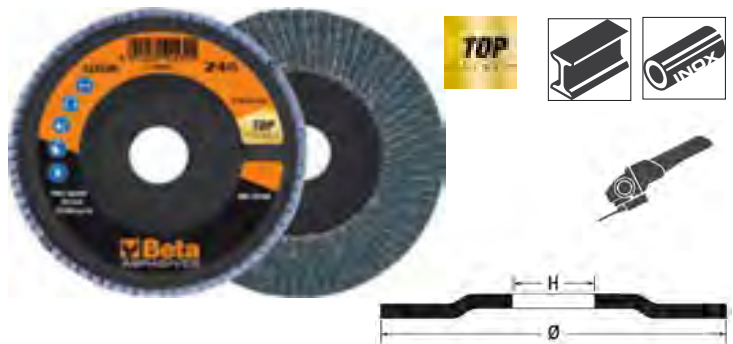

	Ø mm	P	F mm	€		
11212A	115	40	22,23	4,40	10	112120004
11212A	115	60	22,23	4,40	10	112120006
11212A	115	80	22,23	4,40	10	112120008
11212A	115	120	22,23	4,40	10	112120012
<hr/>						
	Ø mm	P	F mm	€		
11212B	125	40	22,23	5,40	10	112120104
11212B	125	60	22,23	5,40	10	112120106
11212B	125	80	22,23	5,40	10	112120108



11214A-11214C

Lamellenscheiben Zirkon Fächerschleifscheibe
Trägermaterial Kunststoff und Doppellamelle

Ausführung gerade
TOP LINE
Ø 115 mm
EN 13743



	Ø mm	P	F mm	€		
11214A	115	40	22,23	4,40	10	112140004
11214A	115	60	22,23	4,40	10	112140006
11214A	115	80	22,23	4,40	10	112140008
11214A	115	120	22,23	4,40	10	112140012

	Ø mm	P	F mm	€		
11214B	125	40	22,23	5,40	10	112140104
11214B	125	60	22,23	5,40	10	112140106
11214B	125	80	22,23	5,40	10	112140108

	Ø mm	P	F mm	€		
11214C	180	40	22,23	10,90	10	112140204
11214C	180	60	22,23	10,90	10	112140206

11216A-11216B

Lamellenscheiben Zirkon Fächerschleifscheibe
Trägermaterial Glasfaser und Einzellamelle

Ausführung gerade
TOP LINE
Ø 115 mm
EN 13743



	Ø mm	P	F mm	€		
11216A	115	40	22,23	4,40	10	112160004
11216A	115	60	22,23	4,40	10	112160006
11216A	115	80	22,23	4,40	10	112160008
11216A	115	120	22,23	4,40	10	112160012

	Ø mm	P	F mm	€		
11216B	125	40	22,23	5,40	10	112160104
11216B	125	60	22,23	5,40	10	112160106
11216B	125	80	22,23	5,40	10	112160108

11218A-11218B

Lamellenscheiben Zirkon Fächerschleifscheibe
Trägermaterial Glasfaser und Doppellamelle

Ausführung gerade
TOP LINE
Ø 115 mm
EN 13743



	Ø mm	P	F mm	€		
11218A	115	40	22,23	4,40	10	112180004
11218A	115	60	22,23	4,40	10	112180006

	Ø mm	P	F mm	€		
11218B	125	40	22,23	5,40	10	112180104
11218B	125	60	22,23	5,40	10	112180106

11220A-11220B

Lamellenscheiben Zirkon Fächerschleifscheibe
Trägermaterial Glasfaser und Einzellamelle

Ausführung konisch
TOP LINE
Ø 115 mm
EN 13743



	Ø mm	P	F mm	€		
11220A	115	40	22,23	4,40	10	112200004
11220A	115	60	22,23	4,40	10	112200006
11220A	115	80	22,23	4,40	10	112200008
11220A	115	120	22,23	4,40	10	112200012

	Ø mm	P	F mm	€		
11220B	125	40	22,23	5,40	10	112200104
11220B	125	60	22,23	5,40	10	112200106
11220B	125	80	22,23	5,40	10	112200108



11222B

Lamellenscheiben mit Zirkon-Schleifsteinen
Trägermaterial Glasfaser und Doppellamelle

Ausführung konisch
TOP LINE
Ø 115 mm
EN 13743



	Ø mm	P	F mm	€		
11222B	125	40	22,23	5,40	10	112220104
11222B	125	60	22,23	5,40	10	112220106
11222B	125	80	22,23	5,40	10	112220108

11230A-11230B

Lamellenscheiben Korund Fächerschleifscheibe
Trägermaterial Kunststoff und Einzellamelle

Ausführung gerade
PREMIUM LINE
Ø 115 mm
EN 13743



	Ø mm	P	F mm	€		
11230A	115	40	22,23	3,30	10	112300004
11230A	115	60	22,23	3,30	10	112300006
11230A	115	80	22,23	3,30	10	112300008
11230A	115	120	22,23	3,30	10	112300012

	Ø mm	P	F mm	€		
11230B	125	40	22,23	4,00	10	112300104
11230B	125	60	22,23	4,00	10	112300106

Beta

11232A

Lamellenscheiben Korund Fächerschleifscheibe
Trägermaterial Kunststoff und Doppellamelle

Ausführung gerade
PREMIUM LINE
Ø 115 mm
EN 13743



	Ø mm	P	F mm	€		
11232A	115	40	22,23	3,30	10	112320004
11232A	115	60	22,23	3,30	10	112320006
11232A	115	80	22,23	3,30	10	112320008
11232A	115	120	22,23	3,30	10	112320012

11234A

Lamellenscheiben Korund Fächerschleifscheibe
Trägermaterial Glasfaser und Einzellamelle

Ausführung gerade
TOP LINE
Ø 115 mm
EN 13743



	Ø mm	P	F mm	€		
11234A	115	40	22,23	3,80	10	112340004
11234A	115	60	22,23	3,80	10	112340006
11234A	115	80	22,23	3,80	10	112340008
11234A	115	120	22,23	3,80	10	112340012

Beta

11240A-11240B

Lamellenscheiben mit Schleifband Zirkonkeramisiert, Trägermaterial Kunststoff und Einzellamelle

Ausführung gerade
 Ø 115 mm
 EN 13743



	Ø mm	P	F mm	€		
11240A	115	40	22,23	6,20	10	112400004
11240A	115	60	22,23	6,20	10	112400006
	Ø mm	P	F mm	€		
11240B	125	40	22,23	7,50	10	112400104
11240B	125	60	22,23	7,50	10	112400106

11242A-11242B

Lamellenscheiben mit Schleifband Zirkonkeramisiert, Trägermaterial Glasfaser und Einzellamelle

Ausführung gerade
 Ø 115 mm
 EN 13743



	Ø mm	P	F mm	€		
11242A	115	40	22,23	6,10	10	112420004
11242A	115	60	22,23	6,10	10	112420006
	Ø mm	P	F mm	€		
11242B	125	40	22,23	7,50	10	112420104
11242B	125	60	22,23	7,50	10	112420106

11246A

Lamellenscheiben mit Schleifband keramisiert, Trägermaterial Kunststoff und Einzellamelle

Ausführung gerade
 Ø 115 mm
 EN 13743



	Ø mm	P	F mm	€		
11246A	115	40	22,23	7,50	10	112460004
11246A	115	60	22,23	7,50	10	112460006

11248A-11248B

Lamellenscheiben mit Schleifband keramisiert, Trägermaterial Glasfaser und Einzellamelle

Ausführung gerade
 Ø 115 mm
 EN 13743



	Ø mm	P	F mm	€		
11248A	115	40	22,23	7,50	10	112480004
11248A	115	60	22,23	7,50	10	112480006
	Ø mm	P	F mm	€		
11248B	125	40	22,23	9,70	10	112480104
11248B	125	60	22,23	9,70	10	112480106

11259

Lamellenscheiben mit Filzlamellen
 Trägermaterial Glasfaser und Einzellamelle

Ausführung gerade



	Ø mm	F mm	€		
11259	115	22,23	12,10	10	112590115
11259	125	22,23	13,90	10	112590125



11260÷11268

Lamellenräder mit Schaft
Lamellen Korund-Schleifsteinen

Schaft Ø 3 mm
EN 13743



	Ø mm	h mm	S mm	P	€		
11260	10	10	3	60	6,10		
11260	15	15	3	60	4,90		

	Ø mm	h mm	S mm	P	€		
11263	30	10	6	60	3,30		
11263	30	15	6	60	3,30		
11263	30	15	6	80	3,30		
11263	30	20	6	40	3,30		
11263	30	20	6	60	3,40		
11263	30	20	6	80	3,40		
11263	30	20	6	120	3,40		

	Ø mm	h mm	S mm	P	€		
11264	40	15	6	60	3,50		
11264	40	15	6	80	3,50		
11264	40	15	6	120	3,50		
11264	40	20	6	40	3,70		
11264	40	20	6	60	3,60		
11264	40	30	6	40	4,10		
11264	40	30	6	60	4,10		

	Ø mm	h mm	S mm	P	€		
11265	50	20	6	60	4,30		
11265	50	20	6	80	4,30		
11265	50	30	6	40	4,90		
11265	50	30	6	60	4,90		
11265	50	30	6	80	4,90		
11265	50	30	6	120	5,10		

	Ø mm	h mm	S mm	P	€		
11266	60	20	6	40	5,10		
11266	60	20	6	60	5,10		
11266	60	30	6	40	5,60		
11266	60	30	6	60	5,60		
11266	60	30	6	80	5,60		
11266	60	30	6	120	6,20		
11266	60	40	6	60	6,60		
11266	60	40	6	80	6,60		

	Ø mm	h mm	S mm	P	€		
11268	80	30	6	60	7,70		
11268	80	30	6	80	7,70		

Beta

11271A÷11271C

Schleif-Vliesräder mit Schaft
Gewebe synthetische Korundfasern

Ø 40 mm
Schaft Ø 6 mm



	Ø mm	h mm	S mm	P	€		
11271A	40	20	6	C	8,00		
11271A	40	20	6	M	8,00		
11271A	40	20	6	F	8,00		
11271A	40	20	6	VF	8,00		

	Ø mm	h mm	S mm	P	€		
11271B	60	30	6	C	9,00		
11271B	60	30	6	M	9,00		
11271B	60	30	6	F	9,00		
11271B	60	30	6	VF	9,00		

	Ø mm	h mm	S mm	P	€		
11271C	80	50	6	C	10,10		
11271C	80	50	6	M	10,10		
11271C	80	50	6	F	10,10		
11271C	80	50	6	VF	10,10		

11276A÷11276C

Kombinierte Vlies-/Leinen Lamellenräder mit Schaft
Lamellen aus Schleifsteinen wird abwechselnd mit Vlies aus
Korundfasern kombiniert

Ø 40 mm
Schaft Ø 6 mm



	Ø mm	h mm	S mm	P	€		
11276A	40	20	6	M/60	9,10		
11276A	40	20	6	M/80	9,10		
11276A	40	20	6	M/120	9,10		

	Ø mm	h mm	S mm	P	€		
11276B	60	30	6	M/60	10,00		
11276B	60	30	6	M/80	10,00		
11276B	60	30	6	M/120	10,00		

Beta

	Ø mm	h mm	S mm	P	€		
11276C	80	50	6	M/60	12,00	10	112760036
11276C	80	50	6	M/80	12,00	10	112760038
11276C	80	50	6	M/120	12,00	10	112760042

11300A÷11300G

Lamellenräder mit Korundleinen und Bohrung

Ø 165 x 30 mm

EN 13743



	Ø mm	H mm	P	F mm	€		
11300A	165	30	40	54	33,00	3	113000004
11300A	165	30	60	54	35,00	3	113000006
11300A	165	30	80	54	36,00	3	113000008
11300A	165	30	120	54	40,00	3	113000012
11300A	165	30	180	54	44,00	3	113000018
11300A	165	30	220	54	43,00	3	113000022

	Ø mm	H mm	P	F mm	€		
11300B	165	50	40	54	45,50	2	113000104
11300B	165	50	60	54	48,00	2	113000106
11300B	165	50	80	54	49,00	2	113000108
11300B	165	50	120	54	55,00	2	113000112
11300B	165	50	180	54	60,50	2	113000118
11300B	165	50	220	54	63,50	2	113000122

	Ø mm	H mm	P	F mm	€		
11300C	200	30	40	54	39,50	3	113000204
11300C	200	30	60	54	42,00	3	113000206
11300C	200	30	80	54	45,50	3	113000208
11300C	200	30	120	54	48,00	3	113000212
11300C	200	30	180	54	51,50	3	113000218

	Ø mm	H mm	P	F mm	€		
11300D	200	50	40	54	55,00	2	113000304
11300D	200	50	60	54	60,50	2	113000306
11300D	200	50	80	54	63,50	2	113000308
11300D	200	50	120	54	69,50	2	113000312
11300D	200	50	180	54	76,00	2	113000318
11300D	200	50	220	54	82,50	2	113000322

	Ø mm	H mm	P	F mm	€		
11300E	250	30	40	100	69,50	3	113000404
11300E	250	30	60	100	73,50	3	113000406
11300E	250	30	80	100	76,00	3	113000408
11300E	250	30	120	100	81,50	3	113000412

	Ø mm	H mm	P	F mm	€		
11300F	250	50	40	100	101,00	2	113000504
11300F	250	50	60	100	103,50	2	113000506
11300F	250	50	80	100	105,50	2	113000508
11300F	250	50	120	100	110,00	2	113000512
11300F	250	50	180	100	130,00	2	113000518
11300F	250	50	220	100	142,00	2	113000522

	Ø mm	H mm	P	F mm	€		
11300G	300	50	40	100	136,00	2	113000604
11300G	300	50	60	100	142,00	2	113000606
11300G	300	50	80	100	146,00	2	113000608

11320

Schleif-Vliesräder mit Bohrung
Gewebe synthetische Korundfasern

Ø 200 x 50 mm

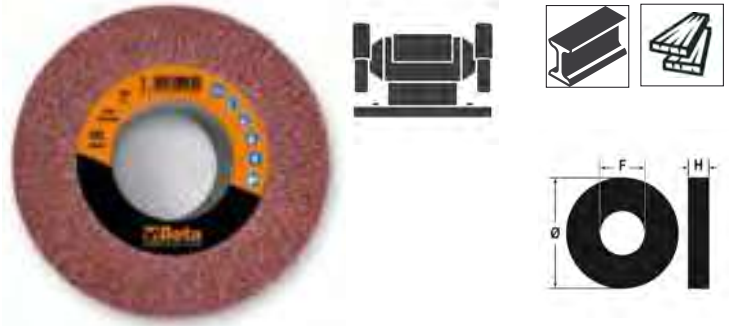

	Ø mm	H mm	P	F mm	€		
11320	200	50	C	76,2	41,50	2	113200006
11320	200	50	M	76,2	41,50	2	113200008
11320	200	50	F	76,2	41,50	2	113200012
11320	200	50	VF	76,2	41,50	2	113200024

11411

Lamellenräder mit Korund-Schleifleinen zum Einsatz auf
Satiniermaschinen

Ø 100 x 100 mm

EN 13743

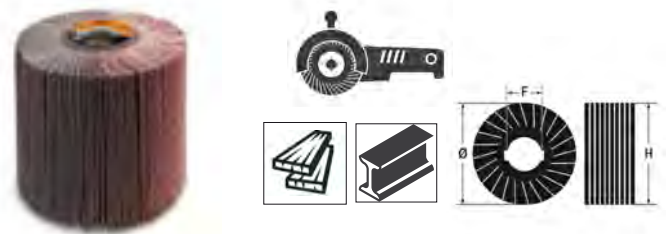

	Ø mm	H mm	P	F mm	€		
11411	100	100	40	19,1	35,00	2	114110004
11411	100	100	60	19,1	38,00	2	114110006
11411	100	100	80	19,1	39,50	2	114110008
11411	100	100	120	19,1	41,50	2	114110012
11411	100	100	240	19,1	42,00	2	114110024

11415B

Vlieswalzen
synthetische Korundfasern für Satiniermaschinen

Ø 100 x 100 mm

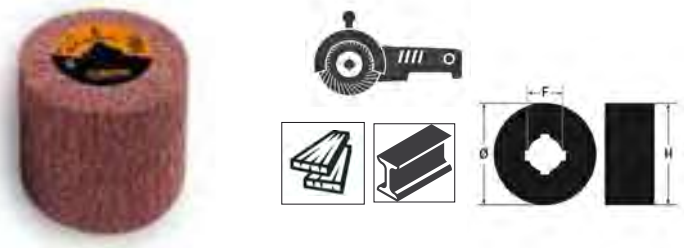

	Ø mm	H mm	P	F mm	€		
11415B	100	100	C	19,1	30,00	2	114150106
11415B	100	100	M	19,1	30,00	2	114150108
11415B	100	100	F	19,1	30,00	2	114150112
11415B	100	100	VF	19,1	30,00	2	114150124

11420B

Kombivlieswalzen für Satiniermaschinen
Schleifleinen wird abwechselnd mit synthetischen Korundfasern kombiniert

Ø 100 x 100 mm

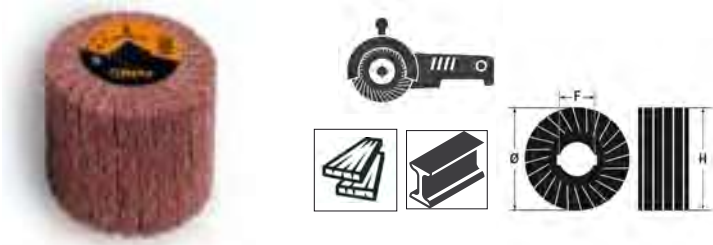

	Ø mm	H mm	P	F mm	€	🚚	📦
11420B	100	100	C/60	19,1	32,00	2	114200106
11420B	100	100	M/80	19,1	32,00	2	114200108
11420B	100	100	F/120	19,1	32,00	2	114200112
11420B	100	100	VF/240	19,1	32,00	2	114200124

11431

Vlies-Schleifteller
synthetische Korundfasern
Ø 115 mm



	Ø mm	P	F mm	€	🚚	📦
11431	115	C	22,23	18,50	4	114310006
11431	115	M	22,23	18,50	4	114310008
11431	115	F	22,23	18,50	4	114310012
11431	115	VF	22,23	18,50	4	114310024

11440A÷11440C

Fiberscheiben mit Zirkon-Schleifleinen

Ø 115 mm



	Ø mm	P	F mm	€	🚚	📦
11440A	115	24	22	1,70	25	114400024
11440A	115	36	22	1,70	25	114400036
11440A	115	60	22	1,50	25	114400060
11440A	115	120	22	1,50	25	114400120

	Ø mm	P	F mm	€	🚚	📦
11440B	125	24	22	2,10	25	114400224
11440B	125	36	22	2,10	25	114400236
11440B	125	60	22	1,90	25	114400260
11440B	125	120	22	1,90	25	114400320

	Ø mm	P	F mm	€	🚚	📦
11440C	180	24	22	3,20	25	114400424
11440C	180	36	22	3,20	25	114400436
11440C	180	60	22	3,00	25	114400460
11440C	180	120	22	3,00	25	114400520

11450A÷11450C

Fiberscheiben mit Korund-Schleifleinen

Ø 115 mm



	Ø mm	P	F mm	€	🚚	📦
11450A	115	24	22	1,40	25	114500024
11450A	115	36	22	1,40	25	114500036
11450A	115	60	22	1,20	25	114500060
11450A	115	120	22	1,20	25	114500120

	Ø mm	P	F mm	€	🚚	📦
11450B	125	24	22	1,40	25	114500224
11450B	125	36	22	1,40	25	114500236
11450B	125	60	22	1,40	25	114500260
11450B	125	120	22	1,40	25	114500320

	Ø mm	P	F mm	€	🚚	📦
11450C	180	24	22	2,20	25	114500424
11450C	180	36	22	2,20	25	114500436
11450C	180	60	22	2,10	25	114500460
11450C	180	120	22	2,10	25	114500520



11488PF

Fiberscheiben Stütz-/Befestigungsteller M14



	Ø mm	€		
11488P	115	9,40	1	114880115
11488P	125	10,30	1	114880125
11488P	180	15,70	1	114880180

11491-11493-11495

Schleifband-Sparrollen Korund

h 38 mm x 50 m



	H mm	L m	P	€		
11491	38	50	40	60,50	1	114910004
11491	38	50	60	59,00	1	114910006
11491	38	50	80	57,50	1	114910008
11491	38	50	100	56,50	1	114910010
11491	38	50	120	56,50	1	114910012
11491	38	50	150	56,50	1	114910015
11491	38	50	180	56,50	1	114910018
11491	38	50	220	56,50	1	114910022
11491	38	50	240	56,50	1	114910024
11491	38	50	320	56,50	1	114910032
11491	38	50	400	56,50	1	114910040

	H mm	L m	P	€		
11493	50	50	40	96,00	1	114930004
11493	50	50	60	87,50	1	114930006
11493	50	50	80	86,00	1	114930008
11493	50	50	100	81,50	1	114930010
11493	50	50	120	81,50	1	114930012
11493	50	50	150	81,50	1	114930015
11493	50	50	180	81,50	1	114930018
11493	50	50	220	81,50	1	114930022
11493	50	50	240	81,50	1	114930024
11493	50	50	320	81,50	1	114930032
11493	50	50	400	81,50	1	114930040

	H mm	L m	P	€		
11495	120	25	40	113,50	1	114950004
11495	120	25	60	110,50	1	114950006
11495	120	25	80	106,50	1	114950008
11495	120	25	100	104,50	1	114950010
11495	120	25	120	104,50	1	114950012
11495	120	25	180	104,50	1	114950018
11495	120	25	240	104,50	1	114950024
11495	120	25	400	104,50	1	114950040

11498

Vliesband-Sparrollen
synthetische Korundfasern

h 100 mm x 10 m



	H mm	L m	P	€		
11498	100	10	M	50,50	1	114980008
11498	100	10	F	41,00	1	114980012
11498	100	10	VF	41,00	1	114980015
* 11498	100	10	UF	44,50	1	114980018



ANPRESSZANGEN FÜR KABELVERBINDUNGEN UND KABELVERBINDUNGEN

		Kabelverbindungen	Abdruck Matrize	Range (mm ²)	Gebrauch
1601/PC					Für Telefon- und Datenübertragungskabelverbindungen 4P/6P/8P
1602				0,75-6	Für isolierte Kabelverbindungen, leichtes Modell
1602A				0-6	Für isolierte Kabelverbindungen, Standardmodell
1603				1,25-5,5	Für nichtisolierte Kabelverbindungen, leichtes Modell
1603A				0-8	Für nichtisolierte Kabelverbindungen mit geschlossenem Schaft, Standardmodell
1603B				0-8	Für nichtisolierte Kabelverbindungen mit offenem Schaft, Standardmodell
1606/2				0,14-10	Für Rundkabelverbindungen, für geringen Kraftaufwand
1606A				0,5-6 6-16	Für Rundkabelverbindungen
1606T				0,1-10	Für Rundkabelverbindungen, 4-Seiten-Crimpen
1607				6,48 5,41 1,69	Für BNC-Verbindungen zum Anschluss von Koaxialkabeln RG 58, RG 59, RG 62, RG 71, für geringen Kraftaufwand
1608				0,5-6	Für isolierte Kabelverbindungen, mit Druckregler
1608A				0,75-6	Für isolierte Kabelverbindungen, für geringen Kraftaufwand
1609				0,5-2,5	Für nichtisolierte Kabelverbindungen
1609A				0,5-6	Für nichtisolierte Kabelverbindungen, für geringen Kraftaufwand
1609B				10-120	Für nichtisolierte Kabelverbindungen



1601/PC

Anpresszange für Telefonkabelverbindungen und Datenübertragung



RJ11-RJ12-RJ45

€ 77,00

2 016010011

1602

Anpresszange für isolierte Kabelverbindungen, leichte Ausführung



mm²
0,75÷6

€ 19,20

5 016020001

1602/C9

Leichte Anpresszange und Sortiment mit 450 Kabelverbindungen



1602/C9

€ 165,00

1 016020045

1602

BM00180	R/6,3	50
BM00280	B/6,3	50
BM00380	G/6,3	50
BM00191	R/6,3	50
BM00291	B/6,3	50
BM00392	G/6,3	50
BM00160	R/1,6	50
BM00260	B/2,3	50
BM00360	G/3,6	50

420x185x60 mm - 1,5 kg

1602A

Anpresszange für isolierte Kabelverbindungen, Standardmodell

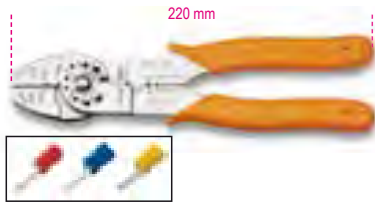

mm² 0÷6 € 70,00 2 016020005

1603

Anpresszange für nichtisolierte Kabelverbindungen, leichte Ausführung

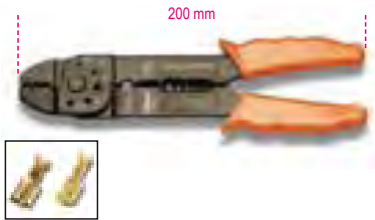

mm² 1,25÷5,5 € 19,20 5 016030001

1603A

Anpresszange für nichtisolierte Kabelverbindungen mit geschlossenem Schaft, Standardmodell

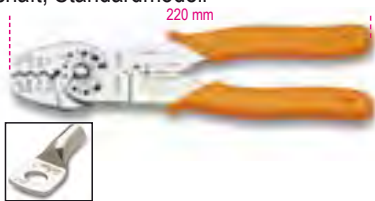

mm² 0÷8 € 70,00 2 016030005

1603B

Anpresszange für nichtisolierte Kabelverbindungen mit offenem Schaft, Standardmodell



mm² 0÷8 € 71,50 2 016030010



1606/2

Anpresszange für Stoßverbinder, für geringen Kraftaufwand



mm² 0,14÷10 L mm 175 A mm 65 B mm 20 € 418,00 1 016060002

1606A

Anpresszange für Rundkabelverbindungen



1606A6 mm² 0,5÷6 € 113,00 1 016060010
1606A16 mm² 6÷16 € 113,00 1 016060016

1606A/C9

anpresszange für Rundkabelverbindungen mit einem Sortiment mit 450 Kabelverbindungen von 0,5 mm² bis 6 mm²



1606A/C9 € 184,00 1 016060045

1606A6		n.
BM00601	W/0,5	50
BM00604	N/1,5	100
BM00506	B/2,5	100
BM00508	G/4	100
BM00610	Y/6	100

420x185x60 mm - 2,5 kg

Beta

1606T

Presszange für Rundkabel, 4-Seiten-Crimpen

Weniger Kraftbeanspruchung des Hebels



mm² 0.1÷10 L mm 173 A mm 61 B mm 13 € 373,00 1 016060005

1607

Anpresszange für BNC-Verbindungen zum Anschluss von Koaxialkabeln RG 58, RG 59, RG 62, RG 71, für geringen Kraftaufwand



1607 mm L 220 mm A 73 mm B 19 € 368,00 1 016070001

1608

Anpresszange für isolierte Kabelverbindungen, mit Druckregler



mm² 0,5÷6 € 144,00 1 016080001

Beta

1608/C9

Anpresszange und Sortiment mit 450 Kabelverbindungen



1608/C9 € 289,00 1 016080045

1608	n.
BM00180 R/6,3	50
BM00280 B/6,3	50
BM00380 G/6,3	50
BM00191 R/6,3	50
BM00291 B/6,3	50
BM00392 G/6,3	50
BM00160 R/1,6	50
BM00260 B/2,3	50
BM00360 G/3,6	50

420x185x60 mm - 2 kg

1608A

Anpresszange für isolierte Kabelverbindungen, für geringen Kraftaufwand



mm² 0,75÷6 € 291,00 1 016080005



1609

Anpresszange für nichtisolierte Kabelverbindungen, für professionellen Gebrauch



mm² 0,5÷2,5 € 144,00 1 016090001

1609A

Anpresszange für nichtisolierte Kabelverbindungen, für geringen Kraftaufwand



mm² 0,5÷6 € 565,00 1 016090005

1609B

Anpresszange für nichtisolierte Kabelverbindungen
Crimpen mit Stempel
von 10 mm² bis 120 mm²



L mm 600 mm² 10÷120 € 382,00 1 016090101

1609C/C5

Öldynamische Anpresszange für Kabelverbindungen mit 5 Matrizenpaaren

Sechskant-Crimpen
von 25 mm² bis 240 mm²



mm² 50÷240 € 2.445,00 1 016090210
500x300x110 mm - 4 kg

1609M

Matrizen für Art. 1609C

Sechskant-Crimpen



Art.	mm ²	€	n.
1609M/16	10-16	88,50	1 016090221
1609M/35	25-35	88,50	1 016090223
1609M/70	50-70	88,50	1 016090225
1609M/120	95-120	88,50	1 016090227
1609M/150	150	88,50	1 016090229
1609M/185	185	88,50	1 016090231
1609M/240	240	88,50	1 016090233

1639S

Einziehband aus Nylon

mit austauschbaren Köpfen



L m 10 Ø mm 4 € 24,70 1 016390010



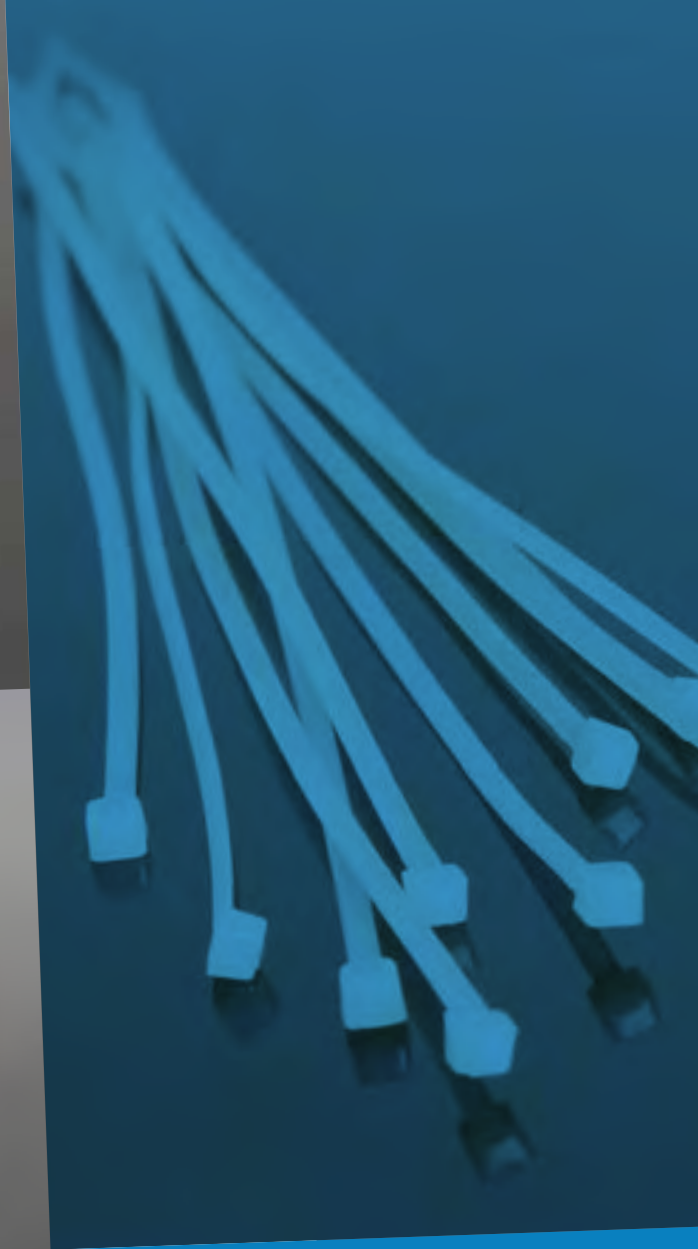

PRODUKTE DER MARKE BM: KABELSCHUHE, KABELBINDER, KLEMMLEISTEN, ISOLIER-/DICHTUNGSBÄNDER

BM Group entwirft, produziert und vertreibt seit 1958 Verbindungselemente und Produkte für Elektroinstallationen. Seit jeher sind Qualität, Sicherheit und Zuverlässigkeit die Hauptpfeiler von BM, jene Werte, die kombiniert mit der Leidenschaft für Spitzenleistung, das Unternehmen Schritt für Schritt zu einem Bezugspunkt im Marktsektor Elektromaterial gemacht hat.

Seit 2018 ist BM Group Teil von Beta Utensili.

In diesem Abschnitt wird eine sorgfältige Auswahl von Produkten der Marke BM, in Ergänzung zu der Produktauswahl Beta vorgestellt.

ZERTIFIZIERTE QUALITÄT



1610-B

Vorisierte Ringkabelschuhe



D mm	mm²	L mm	€	Stk	BM
4	0,25-1,5	20,6	9,50	100	BM00119
5	0,25-1,5	21,8	9,50	100	BM00125
5	1,5-2,5	22,4	9,70	100	BM00225
6	1,5-2,5	26	10,80	100	BM00231
8	1,5-2,5	29,8	12,90	100	BM00237
6	4-6	29,1	16,80	50	BM00331
8	4-6	34,5	20,70	50	BM00337

- Bei der Bestellung die Anzahl von Kabelschuhen und nicht die Packungsanzahl angeben
- Die angegebenen Preise beziehen sich auf 100 Stk.

1614-P

Vorisierte Stiftkabelschuhe

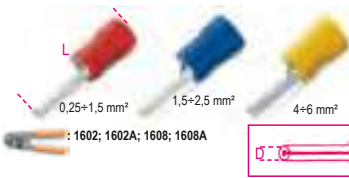

D mm	mm²	L mm	€	Stk	BM
1,9	0,25-1,5	19	9,50	100	BM00151
1,9	1,5-2,5	19	10,10	100	BM00251
2,7	4-6	28	16,60	50	BM00350

- Bei der Bestellung die Anzahl von Kabelschuhen und nicht die Packungsanzahl angeben
- Die angegebenen Preise beziehen sich auf 100 Stk.

1616-SM

Vorisierte Rundstecker

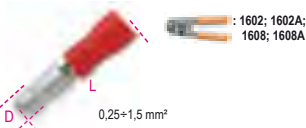

D mm	mm²	L mm	€	Stk	BM
4	0,25-1,5	21	18,70	100	BM00130

- Bei der Bestellung die Anzahl von Kabelschuhen und nicht die Packungsanzahl angeben
- Die angegebenen Preise beziehen sich auf 100 Stk.

1618-SF

Vorisierte Steckhülse



D mm	mm²	L mm	€	Stk	BM
3,8	0,25-1,5	23,5	21,80	100	BM00140

- Bei der Bestellung die Anzahl von Kabelschuhen und nicht die Packungsanzahl angeben
- Die angegebenen Preise beziehen sich auf 100 Stk.

1620-M

Vorisierte Schnellterminals Stecker

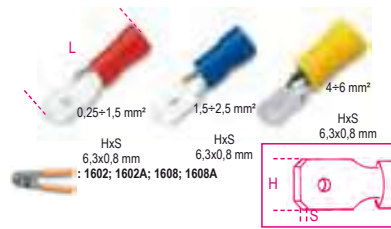

HxS mm	mm²	L mm	€	Stk	BM
6,3x0,8	0,25-1,5	21	18,10	100	BM00180
6,3x0,8	1,5-2,5	21	18,80	100	BM00280
6,3x0,8	4-6	24,5	20,50	50	BM00380

- Bei der Bestellung die Anzahl von Kabelschuhen und nicht die Packungsanzahl angeben
- Die angegebenen Preise beziehen sich auf 100 Stk.

1622-F

Vorisierte Schnellterminals Hülse



HxS mm	mm²	L mm	€	Stk	BM
6,3x0,8	0,25-1,5	20,7	18,40	100	BM00190
2,8x0,5	0,25-1,5	18,5	15,50	100	BM00395
6,3x0,8	1,5-2,5	20,7	18,70	100	BM00290
6,3x0,8	4-6	24,5	26,50	50	BM00391

- Bei der Bestellung die Anzahl von Kabelschuhen und nicht die Packungsanzahl angeben
- Die angegebenen Preise beziehen sich auf 100 Stk.

1624-FI

Isolierte Schnellterminals Hülse



HxS mm	mm²	L mm	€	Stk	BM
6,3x0,8	0,25-1,5	22	20,30	100	BM00191
6,3x0,8	1,5-2,5	22	20,60	50	BM00291
6,3x0,8	4-6	25	25,50	50	BM00392

- Bei der Bestellung die Anzahl von Kabelschuhen und nicht die Packungsanzahl angeben
- Die angegebenen Preise beziehen sich auf 100 Stk.

1628-C

Vorisierte Leitungsverbinder



D mm	mm²	L mm	€	Stk	BM
1,8	0,25-1,5	25	15,30	100	BM00160
2,5	1,5-2,5	26,5	18,00	100	BM00260
3,7	4-6	27	24,90	50	BM00360

- Bei der Bestellung die Anzahl von Kabelschuhen und nicht die Packungsanzahl angeben
- Die angegebenen Preise beziehen sich auf 100 Stk.

1630-CR

Schnellverbinder



mm²	L mm	€	Stk	BM
0,25-1	15,3	15,80	500	BM00110
1,25-2,5	15,9	15,30	500	BM00210

- Bei der Bestellung die Anzahl von Kabelschuhen und nicht die Packungsanzahl angeben
- Die angegebenen Preise beziehen sich auf 100 Stk.

1632-TS

Röhrchen Kabelschuh, einzeln



mm²	L mm	€	Stk	BM
0,5	14	1,90	500	BM00601
0,75	14	1,90	500	BM00602
1	14	1,90	500	BM00603
1,5	14	1,90	500	BM00604
2,5	14	2,50	250	BM00506
4	17	4,00	200	BM00508
6	20	6,40	100	BM00610
0,5	14	1,90	500	BM00501
0,75	14	1,90	500	BM00502
1	14	1,90	500	BM00503
1,5	14	1,80	500	BM00504
6	20	6,10	100	BM00510

- Bei der Bestellung die Anzahl von Kabelschuhen und nicht die Packungsanzahl angeben
- Die angegebenen Preise beziehen sich auf 100 Stk.

1634-TD

Röhrchen Kabelschuh, doppelt



mm²	L mm	€	Stk	BM
2x0,5	15	6,30	200	BM00651
2x0,75	15	4,90	200	BM00652
2x1	15	4,90	200	BM00654
2x1,5	16	5,30	200	BM00656
2x2,5	18,5	6,10	100	BM00558
2x4	23	17,50	100	BM00560
2x6	26	22,80	50	BM00661
2X0,5	15	4,70	200	BM00551
2X0,75	15	4,70	200	BM00552
2X1	15	4,70	200	BM00554
2X1,5	16	5,00	200	BM00556
2X6	26	21,70	50	BM00561

- Bei der Bestellung die Anzahl von Kabelschuhen und nicht die Packungsanzahl angeben
- Die angegebenen Preise beziehen sich auf 100 Stk.





1635-D

Mehrfachklemmen aus Polypropylen,
12-polige Stege

Isolierkörper: natürliches Polypropylen (PP) Leiterkörper: Messing
Unverlierbare Schraube: Verzinkter Stahl
Selbstlöschung: EN 60335-1: 2002+A2:2006 (par. 30.2.3), EN 60695-2-10 bei 850 °C, EN 60695-2-11
Betriebstemperatur: max. 85 °C
Schutzgrad: IP20
Bezugsnormen: EN 60998-1: 2004, EN 60998-2-1: 2004, EN 60335-1: 2002 + A2: 2006 (par. 30.2.3), IEC/EN 60695-2-11



mm ²	L mm	L1 mm	mm ²	€	📦	🚚
16	93,7	14,7	2,5	1,60	50	BM9200
20,5	116,5	17,2	4	2,00	50	BM9201
23,5	139,5	20,1	6	2,90	50	BM9202
25,3	175,5	22,5	16	5,10	25	BM9203
35,2	228	33,5	25	14,00	10	BM9204

1635-S

Klemmenstege für Schweißanschlüsse

Isolierkörper: Durchsichtiges Polycarbonat UL94 V0
Leiterkörper: Messing
Unverlierbare Schraube: Verzinkte Stahl
Selbstlöschung: EN60695-2-10 a 850 °C, EN 60335-1:2002 +A2:2006, EN60695-2-11
Betriebstemperatur: max. 85 °C
Schutzgrad: IP20
Bezugsnormen: EN60998-1: EN60998-2-1:2004



mm ²	L mm	L1 mm	S mm	mm ²	N	€	📦	🚚
1.5	15	7.5	14.5	1.5	2	1,50	10	BM991
					1 2÷3			
					0.75 2÷4			
2.5	17.5	9	18.2	2.5	2	1,60	10	BM992
					1.5 2÷3			
					1 2÷4			
4	21	10.3	20	4	2	2,10	10	BM9924
					2.5 2÷3			
					1.5 2÷4			
6	22.5	11.8	23	6	2	2,40	10	BM993
					4 2÷3			
					2.5 2÷4			
10	26	14.7	26	10	2	4,00	10	BM994
					6 2÷3			
					4 2÷4			
16	31.8	18.8	32.2	16	2	9,40	10	BM995
					10 2÷3			
					6 2÷4			

1635-S



mm ²	L mm	L1 mm	S mm	mm ²	N	€	📦	🚚
25	36.3	22.5	41.9	25	2	4,40	25	BM9960
					16 2÷3			
					10 2÷4			
					16 2÷4			
35	43.5	26.1	49.4	35	2	5,70	25	BM9961
					25 2÷3			
					16 2÷4			
					16 2÷4			



1748-BV2

Nylonkabelbinder, Naturfarbe

Material: Polyamid PA 6.6
Selbstlöschungsklasse: UL 94-V2
Betriebstemperatur: -40 °C + +85 °C
Installations-Mindesttemperatur: -10 °C
Chemikalienbeständigkeit: Gute Beständigkeit gegen Basen, Öle, Fette, Chlorid-Lösungsmittel. Begrenzte Beständigkeit gegen Säuren. Keine Beständigkeit gegen Phenole.
Bezugsnormen: EN 62275:2015-02
Klassifikation: Typ 1 (EN); Typ 21 (UL)



A mm	L mm	Ø MAX mm	F MAX N	€	📦	🚚
2.5	80	14	80	1,70	100	BMB0824
2.5	100	20.5	80	1,50	100	BMB1025
2.5	120	27	80	2,60	100	BMB1225
2.5	160	40	80	3,50	100	BMB1625
2.5	200	52.5	80	3,80	100	BMB2025
3.6	140	33	180	4,10	100	BMB1436
3.6	200	52.5	180	5,60	100	BMB2036
3.6	300	106	180	7,70	100	BMB2936
3.6	370	105	180	12,00	100	BMB3736
4.6	120	24	220	5,30	100	BMB1248
4.6	160	36	220	5,60	100	BMB1648
4.8	188	46	220	6,80	100	BMB1948
4.8	200	50	220	6,70	100	BMB2048
4.8	250	65	220	9,70	100	BMB2548
4.8	300	81	220	9,80	100	BMB3048
4.8	370	103.5	220	12,40	100	BMB3748
4.8	390	110	220	16,90	100	BMB3948
4.8	430	122.5	220	21,80	100	BMB4348
4.8	530	160	220	36,50	100	BMB5348
7.6	150	24	550	18,10	100	BMB1576
7.6	200	51	550	18,70	100	BMB2076
7.6	300	83	550	20,80	100	BMB2976
7.6	370	103.5	550	25,00	100	BMB3776
7.6	450	130.5	550	42,50	100	BMB4576
7.6	540	159	550	55,00	100	BMB5476
7.6	750	226	550	87,50	100	BMB7576
8.8	550	163.5	800	51,50	100	BMB5390
8.8	710	195	800	72,50	100	BMB7190
8.8	780	235.5	800	81,50	100	BMB7890
9.0	430	130.5	800	43,00	100	BMB4390
9.0	810	245	800	96,50	100	BMB8190
9.0	1020	295	800	133,00	100	BMB1090
9.0	1220	375.5	800	173,00	100	BMB1290
9.0	1530	460	800	236,00	100	BMB1590

- Bei der Bestellung bitte die Anzahl von Kabelbindern und nicht die Packungsanzahl angeben
- Die angegebenen Preise beziehen sich auf 100 Stück



1748V

Nylonkabelbinder,
grün

Material: Polyamid PA 6.6
Selbstlöschungsklasse: UL 94-V2
Betriebstemperatur: -40 °C + +85 °C
Installations-Mindesttemperatur: -10 °C
Chemikalienbeständigkeit: Gute Beständigkeit gegen Basen, Öle, Fette, Chlorid-Lösungsmittel. Begrenzte Beständigkeit gegen Säuren. Keine Beständigkeit gegen Phenole
Bezugsnormen: EN 62275:2015-02
Klassifikation: Typ 1 (EN); Typ 21 (UL)

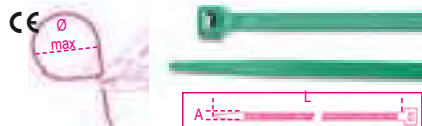

A mm	L mm	Ø MAX mm	F MAX N	€	📦	🚚
2.5	100	20.5	80	1,50	100	BMV1025
3.6	140	33	180	3,60	100	BMV1436
4.8	200	50	220	6,00	100	BMV2048
4.8	300	81	220	8,90	100	BMV3048

- Bei der Bestellung bitte die Anzahl von Kabelbindern und nicht die Packungsanzahl angeben
- Die angegebenen Preise beziehen sich auf 100 Stück

1748N

Nylonkabelbinder,
schwarz,

UV-strahlenbeständig
Material: Polyamid PA 6.6 + carbon black
Selbstlöschungsklasse: UL 94-V2
Betriebstemperatur: -40 °C + +85 °C
Installations-Mindesttemperatur: -10 °C
Chemikalienbeständigkeit: Gute Beständigkeit gegen Basen, Öle, Fette, Chlorid-Lösungsmittel. Begrenzte Beständigkeit gegen Säuren. Keine Beständigkeit gegen Phenole.
Bezugsnormen: EN 62275:2015-02
Klassifikation: Typ 1 (EN)

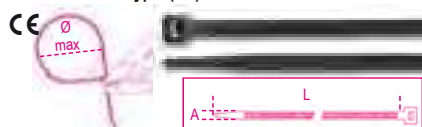

A mm	L mm	Ø mm	F MAX N	€	📦	🚚
2.5	80	14	80	1,70	100	BMN0824
2.5	100	20.5	80	1,50	100	BMN1025
2.5	120	27	80	2,70	100	BMN1225
2.5	160	40	80	3,50	100	BMN1625
2.5	200	52.5	80	3,80	100	BMN2025
3.6	140	33	180	4,10	100	BMN1436
3.6	200	52.5	180	5,50	100	BMN2036
3.6	300	106	180	7,70	100	BMN2936
3.6	370	105	180	12,40	100	BMN3736
4.6	120	24	220	5,30	100	BMN1248
4.6	160	36	220	5,80	100	BMN1648
4.8	188	46	220	6,90	100	BMN1948
4.8	200	50	220	6,70	100	BMN2048
4.8	250	65	220	9,70	100	BMN2548
4.8	300	81	220	9,80	100	BMN3048
4.8	370	103.5	220	12,40	100	BMN3748
4.8	390	110	220	16,90	100	BMN3948
4.8	430	122.5	220	21,80	100	BMN4348
4.8	530	160	220	36,50	100	BMN5348
7.6	150	24	550	18,10	100	BMN1576
7.6	200	51	550	18,70	100	BMN2076
7.6	300	83	550	20,80	100	BMN2976
7.6	370	103.5	550	24,60	100	BMN3776
7.6	450	130.5	550	42,50	100	BMN4576
7.6	540	159	550	55,00	100	BMN5476
7.6	750	226	550	87,50	100	BMN7576
8.8	550	163.5	800	51,50	100	BMN5390
8.8	710	195	800	72,50	100	BMN7190
8.8	780	235.5	800	80,50	100	BMN7890
9.0	430	130.5	800	43,00	100	BMN4390
9.0	810	245	800	96,50	100	BMN8190
9.0	1020	295	800	134,00	100	BMN1090
9.0	1220	375.5	800	173,00	100	BMN1290
9.0	1530	460	800	236,00	100	BMN1590

- Bei der Bestellung bitte die Anzahl von Kabelbindern und nicht die Packungsanzahl angeben
- Die angegebenen Preise beziehen sich auf 100 Stück

1748-UL

Nylonkabelbinder, für schwere Traglasten, schwarz, UV-strahlenbeständig und stoßfest

Material: Polyamid PA 6.6 + carbon black
Selbstlöschungsklasse: UL 94-V2
Betriebstemperatur: -40 °C ÷ +85 °C
Installations-Mindesttemperatur: -10 °C
Chemikalienbeständigkeit: Gute Beständigkeit gegen Basen, Öle, Fette, Chlorid-Lösungsmittel. Begrenzte Bes

CE



A	L	Ø MAX	F MAX	€		
mm	mm	mm	N			
12.4	230	57	1200	53,50	100	BMN2412
12.4	480	136.5	1200	92,00	100	BMN4912
12.4	730	216.1	1200	128,00	100	BMN7412
12.4	880	263.9	1200	153,00	100	BMN8912
12.4	1000	305	1200	183,00	100	BMN1012

- Bei der Bestellung bitte die Anzahl von Kabelbindern und nicht die Packungsanzahl angeben
- Die angegebenen Preise beziehen sich auf 100 Stück

1748-N2D

Nylonkabelbinder, schwarz, UV-strahlenbeständig

Material: Polyamid PA 6.6 + carbon black
Selbstlöschungsklasse: UL 94-V2
Betriebstemperatur: -40 °C ÷ +85 °C
Installations-Mindesttemperatur: -10 °C
Chemikalienbeständigkeit: Gute Beständigkeit gegen Basen, Öle, Fette, Chlorid-Lösungsmittel. Begrenzte Bes

CE



A	L	Ø MAX	F MAX	€		
mm	mm	mm	N			
9.0	180	40	400	27,50	100	BMN1890
9.0	265	62	540	43,50	100	BMN2690
9.0	360	93	540	53,00	100	BMN3690

- Bei der Bestellung bitte die Anzahl von Kabelbindern und nicht die Packungsanzahl angeben
- Die angegebenen Preise beziehen sich auf 100 Stück

1748-BVO

Selbstlöschende Nylonkabelbinder, weiß

Material: Polyamid PA 6.6
Selbstlöschungsklasse: UL 94-V0
Betriebstemperatur: -40 °C ÷ +85 °C
Installations-Mindesttemperatur: -10 °C
Chemikalienbeständigkeit: Gute Beständigkeit gegen Basen, Öle, Fette, Chlorid-Lösungsmittel. Begrenzte Beständigkeit gegen Säuren. Keine Beständigkeit gegen Phenole.
Bezugsnormen: EN 62275:2015-02
Klassifikation: Typ 1 (EN)

CE V0



A	L	Ø MAX	F MAX	€		
mm	mm	mm	N			
2.5	100	20.5	80	2,40	100	BMB1025V0
3.6	150	36.0	180	5,60	100	BMB1536V0
3.6	200	52.5	180	8,00	100	BMB2036V0
4.8	200	49.5	230	8,70	100	BMB2048V0
4.8	300	81.0	230	12,70	100	BMB3048V0
4.8	370	106.7	230	18,20	100	BMB3848V0
7.6	370	106.7	540	32,00	100	BMB3876V0

- Bei der Bestellung bitte die Anzahl von Kabelbindern und nicht die Packungsanzahl angeben
- Die angegebenen Preise beziehen sich auf 100 Stück

1748-BX

Nylonkabelbinder, blau, detektierbar mit metal detector

Material: Polyamid PA 6.6 + Metallpulver
Selbstlöschungsklasse: UL 94-V2
Betriebstemperatur: -40 °C ÷ +85 °C
Installations-Mindesttemperatur: -10 °C
Chemikalienbeständigkeit: Gute Beständigkeit gegen Basen, Öle, Fette, Chlorid-Lösungsmittel. Begrenzte Beständigkeit gegen Säuren. Keine Beständigkeit gegen Phenole.
Bezugsnormen: EN 62275:2015-02
Klassifikation: Typ 1 (EN)

CE

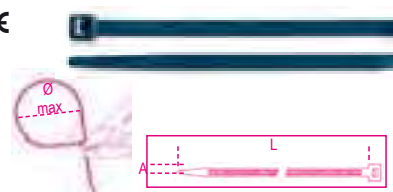

A	L	Ø MAX	F MAX	€		
mm	mm	mm	N			
2.5	100	20.5	80	3,00	100	BMBX1025
3.6	150	36.0	180	7,30	100	BMBX1536
3.6	200	52.5	180	9,80	100	BMBX2036
4.8	200	49.5	230	12,00	100	BMBX2048
4.8	300	81.0	230	17,30	100	BMBX3048
4.8	370	106.7	230	23,40	100	BMBX3848
7.6	370	106.7	540	42,50	100	BMBX3876

- Bei der Bestellung bitte die Anzahl von Kabelbindern und nicht die Packungsanzahl angeben
- Die angegebenen Preise beziehen sich auf 100 Stück

1748-BL

Nylonkabelbinder mit Zahn in Stahl, Naturfarbe

Material: Polyamid PA 6.6 + Stahl
Selbstlöschungsklasse: UL 94-V2
Betriebstemperatur: -40 °C ÷ +85 °C
Installations-Mindesttemperatur: -10 °C
Chemikalienbeständigkeit: Gute Beständigkeit gegen Basen, Öle, Fette, Chlorid-Lösungsmittel. Begrenzte Beständigkeit gegen Säuren. Keine Beständigkeit gegen Phenole.
Bezugsnormen: EN 62275:2015-02
Klassifikation: Typ 1 (EN)

CE

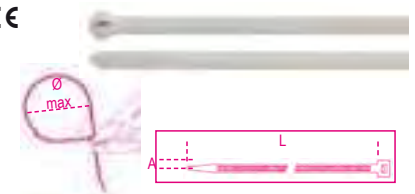

A	L	Ø MAX	F MAX	€		
mm	mm	mm	N			
2.5	100	20.5	180	5,50	100	BMBL1025
2.5	200	52.5	180	7,20	100	BMBL2025
3.6	140	33.0	250	12,30	100	BMBL1436
4.8	200	49.5	360	17,10	100	BMBL2048
4.8	300	81.0	360	22,00	100	BMBL3048
4.8	370	103.5	360	26,50	100	BMBL3748
7.6	370	103.5	780	49,50	100	BMBL3776

- Bei der Bestellung bitte die Anzahl von Kabelbindern und nicht die Packungsanzahl angeben
- Die angegebenen Preise beziehen sich auf 100 Stück

1748-NL

Nylonkabelbinder mit Zahn in Stahl, schwarz, UV-beständig

Material: Polyamid PA 6.6 + Stahl + carbon black
Selbstlöschungsklasse: UL 94-V2
Betriebstemperatur: -40 °C ÷ +85 °C
Installations-Mindesttemperatur: -10 °C
Chemikalienbeständigkeit: Gute Beständigkeit gegen Basen, Öle, Fette, Chlorid-Lösungsmittel. Begrenzte Beständigkeit gegen Säuren. Keine Beständigkeit gegen Phenole.
Bezugsnormen: EN 62275:2015-02
Klassifikation: Typ 1 (EN)

CE

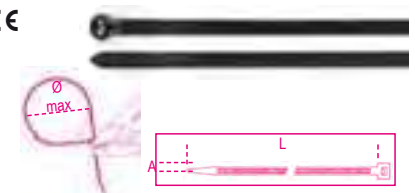

A	L	Ø MAX	F MAX	€		
mm	mm	mm	N			
2.5	100	20.5	180	5,50	100	BMNL1025
2.5	200	52.5	180	7,20	100	BMNL2025
3.6	140	33.0	250	12,30	100	BMNL1436
4.8	200	49.5	360	17,10	100	BMNL2048
4.8	300	81.0	360	22,00	100	BMNL3048
4.8	370	103.5	360	26,50	100	BMNL3748
7.6	370	103.5	780	49,00	100	BMNL3776

- Bei der Bestellung bitte die Anzahl von Kabelbindern und nicht die Packungsanzahl angeben
- Die angegebenen Preise beziehen sich auf 100 Stück

Beta

Beta

1748-BR

Nylonkabelbinder wiederverwendbar,
Naturfarbe

Material: Polyamid PA 6.6
Selbstlöschungsklasse: UL 94-V2
Betriebstemperatur: -40 °C + +85 °C
Installations-Mindesttemperatur: -10 °C
Chemikalienbeständigkeit: Gute Beständigkeit gegen Basen, Öle, Fette, Chlorid-Lösungsmittel. Begrenzte Beständigkeit gegen Säuren. Keine Beständigkeit gegen Phenole.
Bezugsnormen: EN 62275:2015-02
Klassifikation: Typ 1 (EN); Typ 21 (UL)

CE

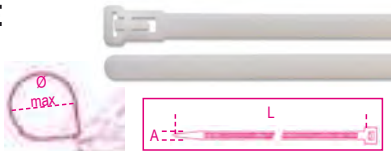

FILE N° E223175

A	L	Ø MAX	F MAX	€	📦	🏭
mm	mm	mm	N			
7.6	150	40	230	18,90	100	BMBR1576
7.6	200	55	230	20,30	100	BMBR2076
7.6	300	82	230	34,00	100	BMBR3076

- Bei der Bestellung bitte die Anzahl von Kabelbindern und nicht die Packungszahl angeben
- Die angegebenen Preise beziehen sich auf 100 Stück

1748-BH

Nylonkabelbinder mit Öse,
Naturfarbe

Material: Polyamid PA 6.6
Selbstlöschungsklasse: UL 94-V2
Betriebstemperatur: -40 °C + +85 °C
Installations-Mindesttemperatur: -10 °C
Chemikalienbeständigkeit: Gute Beständigkeit gegen Basen, Öle, Fette, Chlorid-Lösungsmittel. Begrenzte Beständigkeit gegen Säuren. Keine Beständigkeit gegen Phenole.
Bezugsnormen: EN 62275:2015-02
Klassifikation: Typ 1 (EN); Typ 21 (UL)

CE

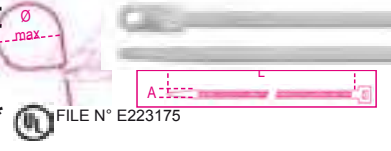

FILE N° E223175

A	L	Ø MAX	F MAX	€	📦	🏭
mm	mm	mm	N			
2.5	110	19.0	80	5,40	100	BMBH1125
* 4.8	200	49.8	230	12,40	100	BMBH2048
* 7.6	305	78.7	550	41,00	100	BMBH3076

- Bei der Bestellung bitte die Anzahl von Kabelbindern und nicht die Packungszahl angeben
- Die angegebenen Preise beziehen sich auf 100 Stück

1748-BP

Nylonkabelbinder Einfügung,
Naturfarbe

Material: Polyamid PA 6.6
Selbstlöschungsklasse: UL 94-V2
Betriebstemperatur: -40 °C + +85 °C
Installations-Mindesttemperatur: -10 °C
Chemikalienbeständigkeit: Gute Beständigkeit gegen Basen, Öle, Fette, Chlorid-Lösungsmittel. Begrenzte Beständigkeit gegen Säuren. Keine Beständigkeit gegen Phenole.
Bezugsnormen: EN 62275:2015-02
Klassifikation: Typ 1 (EN); Typ 21 (UL)

CE

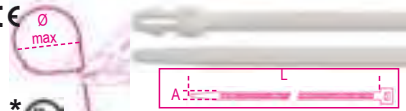

FILE N° E223175

A	L	Ø MAX	F MAX	€	📦	🏭
mm	mm	mm	N			
3.6	155	37.9	180	7,90	100	BMBP1536
* 4.8	200	50.8	230	13,30	100	BMBP2048

- Bei der Bestellung bitte die Anzahl von Kabelbindern und nicht die Packungszahl angeben
- Die angegebenen Preise beziehen sich auf 100 Stück

1748-BT

Nylonkabelbinder mit Querschild 25x8mm,
Naturfarbe

Material: Polyamid PA 6.6
Selbstlöschungsklasse: UL 94-V2
Betriebstemperatur: -40 °C + +85 °C
Installations-Mindesttemperatur: -10 °C
Chemikalienbeständigkeit: Gute Beständigkeit gegen Basen, Öle, Fette, Chlorid-Lösungsmittel. Begrenzte Beständigkeit gegen Säuren. Keine Beständigkeit gegen Phenole.
Bezugsnormen: EN 62275:2015-02
Klassifikation: Typ 1 (EN); Typ 21 (UL)

CE

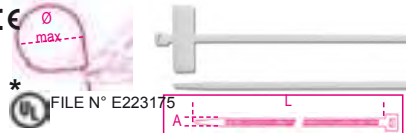

FILE N° E223175

A	L	Ø MAX	F MAX	€	📦	🏭
mm	mm	mm	N			
* 2.5	100	22.0	80	8,70	100	BMBT21025
2.5	200	53.5	80	13,50	100	BMBT22025

- Bei der Bestellung bitte die Anzahl von Kabelbindern und nicht die Packungszahl angeben
- Die angegebenen Preise beziehen sich auf 100 Stück

1748-BT2

Nylonkabelbinder mit Längsschild 13x27mm,
Naturfarbe

Material: Polyamid PA 6.6
Selbstlöschungsklasse: UL 94-V2
Betriebstemperatur: -40 °C + +85 °C
Installations-Mindesttemperatur: -10 °C
Chemikalienbeständigkeit: Gute Beständigkeit gegen Basen, Öle, Fette, Chlorid-Lösungsmittel. Begrenzte Beständigkeit gegen Säuren. Keine Beständigkeit gegen Phenole.
Bezugsnormen: EN 62275:2015-02
Klassifikation: Typ 1 (EN)

CE



A	L	Ø MAX	F MAX	€	📦	🏭
mm	mm	mm	N			
4.8	190	51	230	16,10	100	BMBT12248

- Bei der Bestellung bitte die Anzahl von Kabelbindern und nicht die Packungszahl angeben
- Die angegebenen Preise beziehen sich auf 100 Stück

1748-BT3

Nylonkabelbinder mit Außenschild 20x9mm,
Naturfarbe

Material: Polyamid PA 6.6
Selbstlöschungsklasse: UL 94-V2
Betriebstemperatur: -40 °C + +85 °C
Installations-Mindesttemperatur: -10 °C
Chemikalienbeständigkeit: Gute Beständigkeit gegen Basen, Öle, Fette, Chlorid-Lösungsmittel. Begrenzte Beständigkeit gegen Säuren. Keine Beständigkeit gegen Phenole.
Bezugsnormen: EN 62275:2015-02
Klassifikation: Typ 1 (EN)

CE

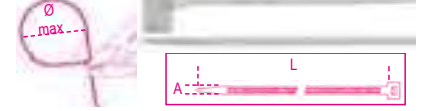

A	L	Ø MAX	F MAX	€	📦	🏭
mm	mm	mm	N			
2.5	110	22	80	8,90	100	BMBT11125

- Bei der Bestellung bitte die Anzahl von Kabelbindern und nicht die Packungszahl angeben
- Die angegebenen Preise beziehen sich auf 100 Stück

1748-BA1

Befestigungssockel

Material: Polyamid PA 6.6
Selbstlöschungsklasse: UL 94-V2
Betriebstemperatur: -40 °C + +85 °C
Installations-Mindesttemperatur: -10 °C
Chemikalienbeständigkeit: Gute Beständigkeit gegen Basen, Öle, Fette, Chlorid-Lösungsmittel. Begrenzte Beständigkeit gegen Säuren. Keine Beständigkeit gegen Phenole.



SxDxH	Ø	F	€	📦	🏭
mm	mm	mm			
15.2x9.4x6.8	3.3	3.6	12,00	100	BMB0905
22x16.2x10.8	5.2	9	27,00	100	BMB0906

- Bei der Bestellung bitte die Anzahl von Kabelbindern und nicht die Packungszahl angeben
- Die angegebenen Preise beziehen sich auf 100 Stück

1748-NA1

Befestigungssockel

Material: Polyamid PA 6.6
Selbstlöschungsklasse: UL 94-V2
Betriebstemperatur: -40 °C + +85 °C
Installations-Mindesttemperatur: -10 °C
Chemikalienbeständigkeit: Gute Beständigkeit gegen Basen, Öle, Fette, Chlorid-Lösungsmittel. Begrenzte Beständigkeit gegen Säuren. Keine Beständigkeit gegen Phenole.



SxDxH	Ø	F	€	📦	🏭
mm	mm	mm			
15.2x9.4x6.8	3.3	3.6	12,40	100	BMN0905
22x16.2x10.8	5.2	9	21,90	100	BMN0906

- Bei der Bestellung bitte die Anzahl von Kabelbindern und nicht die Packungszahl angeben
- Die angegebenen Preise beziehen sich auf 100 Stück



1748-BA2

Befestigungssockel, bidirektional

Material: Polyamid PA 6.6
 Selbstlöschungsklasse: UL 94-V2
 Betriebstemperatur: -40 °C ÷ +85 °C
 Installations-Mindesttemperatur: -10 °C
 Chemikalienbeständigkeit: Gute Beständigkeit gegen Basen, Öle, Fette, Chlorid-Lösungsmittel. Begrenzte Beständigkeit gegen Säuren. Keine Beständigkeit gegen Phenole.

CE

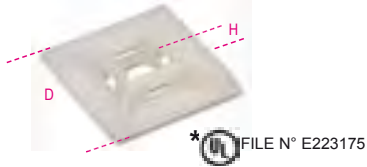

SxDxH mm	F mm	€	100	100
19x19x5.4	3.6	15,10	100	BMB0901
* 28x28x7	4.8	20,60	100	BMB0902
* 28x28x5.8	4.8	18,80	100	BMB0903

1748-NA2

Befestigungssockel, bidirektional,
 UV-beständig

Material: Polyamid PA 6.6
 Selbstlöschungsklasse: UL 94-V2
 Betriebstemperatur: -40 °C ÷ +85 °C
 Installations-Mindesttemperatur: -10 °C
 Chemikalienbeständigkeit: Gute Beständigkeit gegen Basen, Öle, Fette, Chlorid-Lösungsmittel. Begrenzte Beständigkeit gegen Säuren. Keine Beständigkeit gegen Phenole.

CE

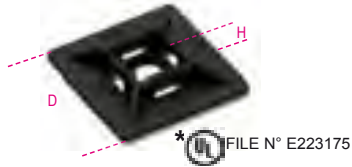

SxDxH mm	F mm	€	100	100
19x19x5.4	3.6	15,10	100	BMN0901
* 28x28x7	4.8	20,60	100	BMN0902
* 28x28x5.8	4.8	18,70	100	BMN0903

- Bei der Bestellung bitte die Anzahl von Kabelbindern und nicht die Packungszahl angeben
 - Die angegebenen Preise beziehen sich auf 100 Stück

1748-S

Selbstsperrende Kabelbinder aus Edelstahl

Material: Edelstahl AISI 304
 Befestigungsvorrichtung: Kugel
 Selbstlöschungsklasse: nicht entflammbar
 Plenum rating: AH-1
 UV-Strahlenbeständigkeit: hervorragend
 Betriebstemperatur: -60 °C ÷ +300 °C
 Installations-Mindesttemperatur: -60 °C
 Chemikalienbeständigkeit: hervorragend
 Bezugsnormen: EN 62275:2015-02
 Klassifikation: Typ 2 (EN); Typ 2 (UL)

CE



A mm	L mm	ØMAX mm	Trazione N	€	100	100
4.6	125	38	890	90,50	100	BMS1345
4.6	200	61.9	890	94,00	100	BMS2045
7.9	200	61.9	1500	99,50	100	BMS2079
4.6	290	90.6	890	101,00	100	BMS3045
7.9	300	90.6	1500	115,50	100	BMS3079
4.6	360	112.8	890	110,50	100	BMS3745
7.9	360	112.8	1500	125,50	100	BMS3779
7.9	500	163.8	1500	148,50	100	BMS5079
4.6	520	163.8	890	110,50	100	BMS5245
4.6	680	214.8	890	117,50	100	BMS6845
7.9	680	214.8	1500	170,00	100	BMS6879
4.6	840	265.7	890	123,00	100	BMS8445
7.9	840	265.7	1500	201,00	100	BMS8479

1748-SC

Selbstsperrende Kabelbinder aus Edelstahl,
 Beschichtung aus schwarzem Polyester

Material: Edelstahl AISI 304 + Polyester
 Befestigungsvorrichtung: Kugel
 Selbstlöschungsklasse: nicht entflammbar
 Plenum rating: AH-1
 UV-Strahlenbeständigkeit: hervorragend
 Betriebstemperatur: -60 °C ÷ +300 °C
 Installations-Mindesttemperatur: -60 °C
 Chemikalienbeständigkeit: hervorragend
 Bezugsnormen: EN 62275:2015-02
 Klassifikation: Typ 2 (EN); Typ 2 (UL)

CE

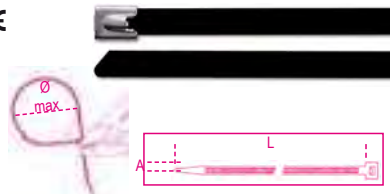

A mm	L mm	ØMAX mm	Trazione N	€	100	100
4.6	125	38	450	94,00	100	BMSC1345
4.6	200	61.9	450	110,00	100	BMSC2045
7.9	200	61.9	800	112,00	100	BMSC2079
4.6	290	90.6	450	122,50	100	BMSC3045
7.9	300	90.6	800	131,00	100	BMSC3079
4.6	360	112.8	450	135,50	100	BMSC3745
7.9	360	112.8	800	147,50	100	BMSC3779
7.9	520	163.8	800	185,50	100	BMSC5079
4.6	520	163.8	450	137,00	100	BMSC5245
4.6	680	214.8	450	155,50	100	BMSC6845
7.9	680	214.8	800	210,50	100	BMSC6879
4.6	840	265.7	450	166,00	100	BMSC8445
7.9	840	265.7	800	253,00	100	BMSC8479

1748-BV

Kabelbinder aus Klettverschluss,
 weiß

Material: Polyethylen-Polyamid (PE-PA)
 Betriebstemperatur: -20 °C ÷ +60 °C

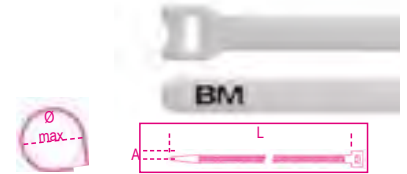

A mm	L mm	Ø MAX mm	F MAX N	€	100	100
12,7	229	55	180	265,00	10	BMBV2312
19	229	55	220	304,00	10	BMBV2319

- Bei der Bestellung bitte die Anzahl von Kabelbindern und nicht die Packungszahl angeben
 - Die angegebenen Preise beziehen sich auf 100 Stück

1748-NV

Kabelbinder aus Klettverschluss,
 schwarz

Material: Polyethylen-Polyamid (PE-PA)
 Betriebstemperatur: -20 °C ÷ +60 °C



A mm	L mm	Ø MAX mm	F MAX N	€	100	100
12,7	229	55	180	265,00	10	BMNV2312

- Bei der Bestellung bitte die Anzahl von Kabelbindern und nicht die Packungszahl angeben
 - Die angegebenen Preise beziehen sich auf 100 Stück

1743

Anpresszange für Nylonkabelbinder

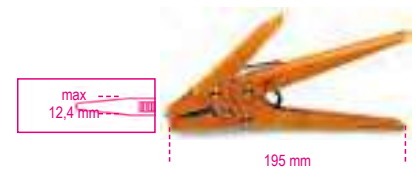

1743	€ 64,50	1	017430001
------	---------	---	-----------

1743T

Anpresszange für Kabelbinder

• Auch geeignet für das Schneiden von kleinen Kabeln (3x1.5mm²; 1x17mm²)



1743T	€ 38,50	1	017430100
-------	---------	---	-----------

Beta

Beta
 WORLDWIDE

1748-N

Zangen für Nylonkabelbinder, Breite 2.5 ÷ 4.8 mm

Automatisches Schneiden beim Erreichen der eingestellten Spannung.
Spannung verstellbar

Material: Gehäuse aus Polymer und Glasfaser, Innenteile aus Metall

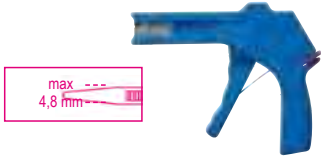

BM1100 € 72,00 1 BM1100

1748-ST

Automatische Zangen für Kabelbinder aus rostfreiem Stahl, für Kabelbinder von 4,6 bis 9 mm, mit automatischer Spannungs- und Abschneidemechanismus



BM1105 € 278,00 1 BM1105

1638M

Warmschrumpfschläuche, dünn, in Minibox

Schrumpfverhältnis: 2:1
Material: Polyäthylen
Betriebstemperatur: -55 °C + +125 °C
Schrumpftemperatur: +70 °C + +125 °C
Max. VRMS: 600 V
Selbstlöschungsgrad des Schlauchs: VW-1 / UL 224
Halogenfrei



L mm	Ø1 mm	Ø2 mm	€	1	BMGBS016MNE
1,6	1,6	0,8	21,20	1	BMGBS016MNE
2,4	2,4	1,2	21,20	1	BMGBS024MNE
3,2	3,2	1,6	21,20	1	BMGBS032MNE
4,8	4,8	2,4	21,20	1	BMGBS048MNE
6,4	6,4	3,2	21,20	1	BMGBS064MNE
9,5	9,5	4,8	21,20	1	BMGBS095MNE
12,7	12,7	6,4	21,20	1	BMGBS127MNE
19	19,1	9,5	21,60	1	BMGBS190MNE
25,4	25,4	12,7	22,00	1	BMGBS254MNE

1639ESB

PVC-Isolierband

Anwendungstemperatur: 0-90 °C
Zugfestigkeit: 28N/cm entspricht 18.6 N/mm²
Reißdehnung: 200%
Stahlhafffestigkeit: 2.2N/cm
Rückseitenhafffestigkeit: 2 N/cm
Durchschlagsfestigkeit: 45kV/mm
Entflammbarkeit: Flammschutzmitte
Bezugsnormen: IEC 60454-2
Klassifikation: CEI EN 60454-3-1-5/F-PVCP/90



S mm	A mm	L m	€	10	BMESB1510BI
0.15	15	10	1,00	10	BMESB1510BI
0.15	15	10	1,00	10	BMESB1510BL
0.15	15	10	1,00	10	BMESB1510GI
0.15	15	10	1,00	10	BMESB1510GR
0.15	15	10	1,20	10	BMESB1510GV
0.15	15	10	1,00	10	BMESB1510MA
0.15	15	10	1,00	10	BMESB1510NE
0.15	15	10	1,00	10	BMESB1510RO
0.15	15	10	1,00	10	BMESB1510VE
0.15	15	25	2,50	10	BMESB1525BI
0.15	15	25	2,50	10	BMESB1525BL
0.15	15	25	2,50	10	BMESB1525GI
0.15	15	25	2,50	10	BMESB1525GR
0.15	15	25	2,60	10	BMESB1525GV
0.15	15	25	2,50	10	BMESB1525MA
0.15	15	25	2,50	10	BMESB1525NE
0.15	15	25	2,50	10	BMESB1525RO
0.15	15	25	2,50	10	BMESB1525VE
0.15	19	25	2,60	10	BMESB1925BI
0.15	19	25	2,60	10	BMESB1925BL
0.15	19	25	2,60	10	BMESB1925GI
0.15	19	25	2,60	10	BMESB1925GR
0.15	19	25	2,80	10	BMESB1925GV
0.15	19	25	2,60	10	BMESB1925MA
0.15	19	25	2,60	10	BMESB1925NE
0.15	19	25	2,60	10	BMESB1925RO
0.15	19	25	2,60	10	BMESB1925VE
0.15	25	25	3,80	8	BMESB2525BI
0.15	25	25	3,80	8	BMESB2525BL
0.15	25	25	3,80	8	BMESB2525GI
0.15	25	25	3,80	8	BMESB2525GR
0.15	25	25	3,90	8	BMESB2525GV
0.15	25	25	3,80	8	BMESB2525MA
0.15	25	25	3,80	8	BMESB2525NE
0.15	25	25	3,80	8	BMESB2525RO
0.15	25	25	3,80	8	BMESB2525VE
0.15	50	25	5,60	4	BMESB5025NE

1639ESC

PVC-Isolierband

Betriebstemperatur: 0-80 °C
Zugfestigkeit: 28N/cm entspricht 18.6 N/mm²
Reißdehnung: 200%
Stahlhafffestigkeit: 2.2N/cm
Rückseitenhafffestigkeit: 2.2 N/cm
Durchschlagsfestigkeit: 38kV/mm
Entflammbarkeit: Flammschutzmitte
Bezugsnormen: ASTM-D-1000 ; UL510
Klassifikation: CEI EN 60454-3-1-5/F-PVCP/90



S mm 0.18 A mm 19 L m 20 € 3,60 10 BMESC1920NE

1639ETA

PVC-Isolierband für extreme Außentemperaturen

Betriebstemperatur: -18 ÷ +105 °C
Zugfestigkeit: 35N/cm entspricht 19.4 N/mm²
Reißdehnung: 300%
Stahlhafffestigkeit: 3.1N/cm
Rückseitenhafffestigkeit: 2.7 N/cm
Durchschlagsfestigkeit: 55.5kV/mm
Entflammbarkeit: Flammschutzmitte
Bezugsnormen: ASTM-D-1000 ; UL510 Klassifikation: CEI EN 60454-3-1-5/F-PVCP/90



S mm 0.18 A mm 19 L m 20 € 10,40 1 BMETA1920NE

1639EAB

Isolierband selbstverschweißend auf EPR-Basis

Betriebstemperatur: -40 ÷ +90 °C
Zugfestigkeit: 2.4 N/mm²
Reißdehnung: 750%
Durchschlagsfestigkeit: 29.5kV/mm
Entflammbarkeit: Flammschutzmitte
Bezugsnormen: ASTM-D-4388; ASTM-D-4325
Ausgezeichnete Beständigkeit gegen: Feuchtigkeit, Korrosion und Chemikalien



S mm 0.76 A mm 19 L m 9 € 21,20 1 BMEAB1909NE





BLISTER-SORTIMENT

für Ihren
Self-Service-
Verkauf!

- **Bessere Sichtbarkeit**
- **Ausstellungseffizienz**
- **Strichcode**



BLISTERHALTERUNG:

- Reißfester PVC
- 4 Formate zur Optimierung des Ausstellungsraums
- Befestigungssystem der neuen Generation mit Gummiband

42K



mm	€	U	PC
5,5x5,5	9,70	5	000429505
6x6	9,80	5	000429506
7x7	10,00	5	000429507
8x8	10,20	5	000429508
9x9	10,80	5	000429509
10x10	11,10	5	000429510
11x11	11,80	5	000429511
12x12	11,90	5	000429512
13x13	11,90	5	000429513
14x14	13,60	5	000429514
15x15	15,00	5	000429515
16x16	15,40	5	000429516
17x17	16,20	5	000429517
18x18	17,20	5	000429518
19x19	17,80	5	000429519
20x20	19,90	3	000429520
21x21	21,40	3	000429521
22x22	22,10	3	000429522
23x23	23,80	3	000429523
24x24	24,80	3	000429524
25x25	26,50	2	000429525
26x26	28,50	2	000429526
27x27	31,00	2	000429527
28x28	31,50	2	000429528
29x29	35,00	2	000429529
30x30	35,50	2	000429530
32x32	40,00	2	000429532

55K



mm	€	U	PC
6x7	6,50	5	000559012
8x9	6,70	5	000559021
10x11	7,00	5	000559030
10x12	9,40	5	000559033
10x13	10,30	5	000559035
12x13	7,90	5	000559042
12x14	10,50	5	000559045
13x17	12,40	5	000559051
14x15	9,90	5	000559054
14x17	13,30	5	000559057
16x17	11,20	5	000559060
17x19	14,80	2	000559063
18x19	13,30	2	000559066
19x22	16,80	2	000559069
20x22	14,80	2	000559075
21x23	15,70	2	000559078
22x24	18,10	2	000559081
24x26	18,60	2	000559087
24x27	20,20	2	000559090
25x28	21,20	2	000559096
27x29	24,00	2	000559099
27x30	27,50	2	000559102
30x32	26,50	2	000559108

90K



mm	€	U	PC
6x7	12,10	5	000909006
8x9	13,00	5	000909012
10x11	14,10	5	000909018
12x13	15,30	5	000909027
14x15	16,80	5	000909033
16x17	19,10	5	000909039
18x19	22,20	5	000909045

mm	€	U	PC
20x22	25,50	3	000909051
21x23	28,50	2	000909057
24x26	32,00	2	000909063
24x27	35,50	2	000909067
25x28	38,50	2	000909070
27x29	41,50	2	000909073
30x32	46,50	2	000909080

93K



mm	€	U	PC
21x22	48,50	3	000939021

94K



mm	€	U	PC
8x10	20,70	2	000949008
9x11	21,50	2	000949009
10x11	22,50	2	000949010
11x13	23,20	2	000949011
12x14	24,60	2	000949012
13x15	24,60	2	000949013
14x15	29,00	2	000949014
14x17	30,00	2	000949015
17x19	30,50	2	000949017
19x22	32,50	2	000949019
22x24	39,50	2	000949022
24x27	43,50	2	000949024
30x32	56,00	2	000949030

96/SC9



mm	€	U	PC
1,5-2-2,5-3-4-5-6-8-10	24,40	1	000960374

96/ST6K



mm	€	U	PC
2,5-3-4-5-6-8	17,20	3	000969370

96N/ST6K



mm	€	U	PC
2,5-3-4-5-6-8	12,30	3	000969640

96BPA/SC9



mm	€	U	PC
1,5-2-2,5-3-4-5-6-8-10	56,00	1	000961974

96BP-CL/SC9



mm	€	U	PC
1,5-2-2,5-3-4-5-6-8-10	62,00	1	000961619

96BPC/SC9



mm	€	U	PC
1,5-2-2,5-3-4-5-6-8-10	50,50	1	000960354

96C/AS



mm	€	U	PC
1/16	2,10	20	000961702
3/32	2,80	20	000961706
1/8	3,10	20	000961710
5/32	3,50	20	000961714
3/16	4,00	20	000961716
7/32	4,50	20	000961718
1/4	4,90	20	000961720
5/16	5,60	10	000961724
3/8	6,80	10	000961728

96LBP/SC9



96LBP/SC9 1,5-2-2,5-3-4-5-6-8-10 mm	€ 59,50	1	000961354
---	---------	---	-----------

96/BGS7



96/BGS7 1,5-2-2,5-3-4-5-6 mm	€ 36,50	1	000960367
--	---------	---	-----------

96/BG7



96/BG7 2,5-3-4-5-6-8-10 mm	€ 38,50	1	000960368
--------------------------------------	---------	---	-----------

96TK



mm	€		
2	14,10	5	000969934
2,5	14,10	5	000969935
3	14,80	5	000969936
4	15,30	5	000969938
5	15,50	5	000969940
6	17,80	5	000969941
8	22,50	3	000969943
10	26,00	3	000969945

97BTX/SC8



97BTX/SC8 T9-T10-T15-T20-T25-T27-T30-T40	€ 91,00	1	000970164
--	---------	---	-----------

97BTXL/SC8



97BTXL/SC8 T9-T10-T15-T20-T25-T27-T30-T40	€ 105,00	1	000970364
---	----------	---	-----------

111E



L mm	€		
100	29,00	3	001110110
150	30,00	3	001110115
200	37,00	3	001110120
250	44,50	3	001110125
300	59,00	3	001110130
380	116,00	3	001110138
450	193,00	2	001110145
600	267,00	1	001110160

111EN



L mm	€		
100	26,50	3	001110410
150	28,00	3	001110415
200	32,50	3	001110420
250	40,50	3	001110425
300	54,00	3	001110430
380	107,50	3	001110438
450	182,50	2	001110445

111ER



L mm	€		
200	38,50	3	001110520
250	47,50	3	001110525
300	62,00	2	001110530

123/K4



123/K4	€ 38,00	1	001230504
---------------	---------	---	-----------

142K



mm	€		
6	20,90	3	001429006
7	20,90	3	001429007
8	21,60	3	001429008
9	23,20	3	001429009
10	23,70	3	001429010
11	24,40	3	001429011
12	25,00	3	001429012
13	27,00	3	001429013
14	27,50	2	001429014
15	29,50	2	001429015
16	32,50	2	001429016
17	33,00	2	001429017
18	35,00	2	001429018
19	36,00	2	001429019
21	46,50	1	001429021
22	48,00	1	001429022
24	56,00	1	001429024

192/S2

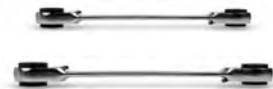

192/S2 8x10/12x13 mm 16x17/18x19 mm	€ 75,00	1	001920070
--	---------	---	-----------

195K



mm	€		
8x10	23,90	2	001959010
12x13	27,00	2	001959013
14x15	29,00	2	001959015
16x18	33,50	2	001959018
17x19	35,00	2	001959019

374K



374K	€ 44,50	1	003749024
-------------	---------	---	-----------



850MQ



L mm	€	1	008500910
233	28,00	1	008500910

855P



L1 mm	€	1	008550010
240	86,00	1	008550010

860/58K



L mm	€	1	008609884
126	91,50	1	008609884

860LP



SxA mm	€	5	008600005
0,5x3	2,40	5	008600005
0,6x4,5	2,40	5	008600010
0,8x5,5	2,40	5	008600015
1x5,5	2,40	5	008600020
1,2x6,5	2,40	5	008600025

860PH



PH	€	5	008600220
0	2,40	5	008600220
1	2,40	5	008600225
2	2,40	5	008600230
3	2,40	5	008600245
4	3,30	5	008600250

860PZ



PZ	€	5	008600320
1	2,40	5	008600320
2	2,40	5	008600325
3	2,40	5	008600330
4	3,30	5	008600335

860PE



mm	€	5	008600101
2	2,50	5	008600101
2,5	2,50	5	008600102
3	2,50	5	008600103
4	2,50	5	008600104
5	2,50	5	008600105
6	2,50	5	008600106
8	3,10	5	008600108
10	3,10	5	008600110

860TX



Ø	€	5	008600704
T6	3,10	5	008600704
T7	3,10	5	008600705
T8	3,10	5	008600710
T9	3,10	5	008600715
T10	2,50	5	008600720
T15	2,50	5	008600725
T20	2,50	5	008600730
T25	2,50	5	008600735
T27	2,50	5	008600740
T30	2,50	5	008600745
T40	2,50	5	008600750

860RTX



Ø	€	5	008600550
T9	3,30	5	008600550
T10	3,30	5	008600555
T15	3,30	5	008600560
T20	3,30	5	008600565
T25	3,30	5	008600570
T27	3,30	5	008600575
T30	3,30	5	008600580
T40	3,30	5	008600585

860/C27

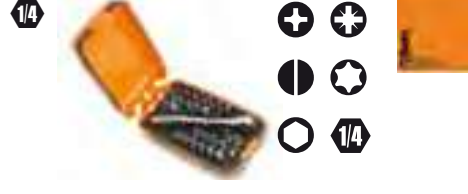

860/C27	€	1	008600880
860/C27	104,50	1	008600880

860MIX/A10



860MIX/A10	€	1	008600900
860MIX/A10	44,00	1	008600900

860TX/A10



860TX/A10	€	1	008600970
860TX/A10	46,50	1	008600970

860MIX/A31



860MIX/A31	€	1	008600902
860MIX/A31	103,00	1	008600902

862F/A7



862F/A7	€	1	008620950
862F/A7	59,50	1	008620950

900K



mm	€	10	009009040
4	5,10	10	009009040
4,5	5,10	10	009009045
5	5,10	10	009009050
5,5	5,10	10	009009055
6	5,10	10	009009060
7	5,10	10	009009070
8	5,10	10	009009080
9	5,10	10	009009090
10	5,10	10	009009100
11	5,10	10	009009110
12	5,10	10	009009120
13	5,10	10	009009130
14	5,20	10	009009140

900/20LK



L mm	€	5	009009819
100	11,10	5	009009819

900/25K

14"



L mm	€		
41	20,50	5	009009830

900BG/30K

14"



L mm	€		
128	10,80	5	009009834

900/55K

3/8"

14"



L mm	€		
125	54,50	5	009009870

900/55ZK

3/8"

14"



L mm	€		
125	54,50	3	009009882

900/58K

14"

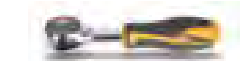

L mm	€		
126	83,00	2	009009884

910AK

3/8"

3/8"



Ø mm	€		
6	7,90	5	009109006
7	7,90	5	009109007
8	7,90	5	009109008
9	7,90	5	009109009
10	7,90	5	009109010
11	7,90	5	009109011
12	8,00	5	009109012
13	8,00	5	009109013
14	8,00	5	009109014
15	8,00	5	009109015
16	9,00	5	009109016
17	9,00	5	009109017
18	9,00	5	009109018
19	9,00	5	009109019
20	9,60	5	009109020
21	9,60	5	009109021
22	9,80	5	009109022

910/21K

3/8"



L mm	€		
125	14,10	5	009109822

910/25K

3/8"



L mm	€		
54,6	25,50	5	009109830

910/55K

7/16"

3/8"



L mm	€		
200	59,00	3	009109882

910/58K

3/8"



L mm	€		
222	91,00	1	009109884

920AK

12"

12"



Ø mm	€		
10	7,90	10	009209010
11	7,90	10	009209011
12	7,90	10	009209012
13	8,20	10	009209013
14	8,20	10	009209014
15	8,20	10	009209015
16	9,20	10	009209016
17	9,20	10	009209017
18	9,20	10	009209018
19	9,20	10	009209019
20	9,90	5	009209020
21	9,90	5	009209021
22	9,90	5	009209022
23	11,50	5	009209023
24	11,50	5	009209024
25	11,50	5	009209025
26	12,00	5	009209026
27	12,00	5	009209027
28	12,00	5	009209028
29	12,50	5	009209029
30	12,50	5	009209030
32	12,90	5	009209032

920/21K

12"



L mm	€		
125	19,30	5	009209822

920/25K

12"



L mm	€		
75	30,50	5	009209830

920/55K

7/16"

12"



L mm	€		
275	72,00	3	009209882

920/58K

12"



L mm	€		
281	109,00	1	009209926

935K



Ø mm	€		
6x7	9,70	5	009359105
8x9	10,50	5	009359111
10x11	11,60	5	009359115
12x13	13,20	5	009359117
14x15	15,00	5	009359126
16x17	16,40	5	009359128
18x19	19,30	5	009359131
20x22	23,20	3	009359138

937K



Ø mm	€		
6x6	10,50	5	009379006
7x7	10,90	5	009379007
8x8	11,40	5	009379008
9x9	12,00	5	009379009
10x10	12,50	5	009379010
11x11	13,20	5	009379011
12x12	14,40	5	009379012
13x13	14,80	5	009379013
14x14	16,10	5	009379014
15x15	17,80	5	009379015
16x16	19,20	5	009379016
17x17	19,90	5	009379017
18x18	20,40	5	009379018
19x19	21,20	5	009379019
20x20	23,90	5	009379020
21x21	26,00	3	009379021
22x22	27,50	3	009379022

943BXK



mm	€	U	Icon
5,5	20,40	5	009439005
6	20,40	5	009439006
7	21,80	5	009439007
8	21,80	5	009439008
10	23,90	3	009439010
13	25,00	3	009439013

951K



mm	€	U	Icon
2	22,50	5	009519521
2,5	22,50	5	009519525
3	22,50	5	009519530
3,5	23,20	5	009519535
4	23,20	5	009519540
4,5	25,50	5	009519545
5	25,50	5	009519550
6	29,00	5	009519560
8	32,00	5	009519580
10	39,50	5	009519610

1032K



L mm	€	U	Icon
140x0,9	30,00	5	010329013
140x1,3	30,00	5	010329014
180	32,00	5	010329017

1033K



L mm	€	U	Icon
140x0,9	34,00	5	010339013
140x1,3	33,50	5	010339014
180	35,00	5	010339017

1034K



L mm	€	U	Icon
130x0,9	34,00	5	010349013
130x1,3	33,50	5	010349014
170	35,00	5	010349017

1036K



L mm	€	U	Icon
140x0,9	33,00	5	010369013
140x1,3	32,00	5	010369014
175	33,50	5	010369017

1037K



L mm	€	U	Icon
140x0,9	36,00	5	010379013
140x1,3	35,00	5	010379014
175	36,00	5	010379017

1038K



L mm	€	U	Icon
135x0,9	36,00	5	010389013
135x1,3	35,00	5	010389014
175	36,00	5	010389017

1044NK



L mm	€	U	Icon
250	31,00	5	010449025

1048NK



L mm	€	U	Icon
175	32,50	3	010489910
250	34,50	5	010489915

1048VNK



L mm	€	U	Icon
175	32,00	3	010489111
250	36,50	5	010489116

1052K



L mm	€	U	Icon
140	32,50	3	010529014
190	36,00	3	010529019
240	39,50	3	010529024

1082K



L mm	€	U	Icon
140	31,50	5	010829004
160	33,00	5	010829006

1082GK



L mm	€	U	Icon
140	27,00	5	010829064
160	28,00	5	010829066

1082BMK



L mm	€	U	Icon
140	38,50	3	010829034
160	43,00	3	010829036

1082GBMK



L mm	€	U	Icon
140	34,00	3	010829264
160	38,50	3	010829266

1084K



L mm	€	U	Icon
160	36,00	3	010849006

1084GK



L mm	€		
160	32,00	5	010849066

1084BMK



L mm	€		
160	44,50	3	010849036

1084GBMK



L mm	€		
160	49,00	3	010849266

1088K



L mm	€		
160	45,00	2	010889006

1088BMK



L mm	€		
160	54,50	2	010889036

1096K



L mm	€		
200	28,00	5	010969020

1098K



L mm	€		
190	24,20	5	010989190
220	27,50	5	010989220

1098PLK



L mm	€		
220	30,00	5	010989320

1112K



L mm	€		
200	32,00	2	011129020

1122K



L mm	€		
250	43,50	2	011229020

1123K



L mm	€		
250	43,50	2	011239020

1124K



L mm	€		
250	43,50	2	011249020

1128BAX



L mm	€		
150	39,50	5	011280088

1128BMX



L mm	€		
147	21,20	5	011280051

1128BSX



L mm	€		
148	36,50	5	011280061

1128FX



L mm	€		
145	38,50	5	011280090

1128FXS



L mm	€		
145	46,00	5	011280095

1129BMK



L mm	€		
145	20,60	5	011299000

1130BMX



L mm	€	AV	Icon
185	23,70	1	

1132K



L mm	€	AV	Icon
170	61,00	2	

1132BMK



L mm	€	AV	Icon
170	75,00	2	

1142BMK



L mm	€	AV	Icon
160	49,50	3	

1144T



L mm	€	AV	Icon
112	25,00	1	

1149F



L mm	€	AV	Icon
175	20,80	1	

1150K



L mm	€	AV	Icon
160	27,50	5	
180	30,00	5	
200	33,50	5	
220	36,00	2	

1150GK



L mm	€	AV	Icon
160	26,00	5	
180	27,50	5	
200	31,50	5	
220	33,00	2	

1150BMK



L mm	€	AV	Icon
160	34,00	3	
180	38,00	3	
200	41,00	3	
220	44,50	2	

1150GBMK



L mm	€	AV	Icon
160	32,50	3	
180	34,00	3	
200	39,00	3	
220	41,00	2	

1162K



L mm	€	AV	Icon
160	32,50	5	
200	38,00	5	

1162GK



L mm	€	AV	Icon
160	27,50	5	
200	32,50	5	

1162BMK



L mm	€	AV	Icon
160	39,50	3	
200	44,50	3	

1162GBMK



L mm	€	AV	Icon
160	34,00	3	
200	40,00	3	

1164K



L mm	€	AV	Icon
160	35,50	5	
200	39,50	5	

1164BMK



L mm	€	AV	Icon
160	43,50	3	
200	49,00	3	

1166K



L mm	€	AV	Icon
160	32,50	5	
200	38,00	5	

1166GK



L mm	€	Handedness	Quantity	Code
160	27,50	5	3	011669066
200	32,50	5	3	011669070

1166BMK



L mm	€	Handedness	Quantity	Code
160	39,50	3	3	011669036
200	44,50	3	3	011669040

1166GBMK



L mm	€	Handedness	Quantity	Code
160	34,00	3	3	011669266
200	40,00	3	3	011669270

1168K



L mm	€	Handedness	Quantity	Code
160	35,50	5	3	011689006
200	39,50	5	3	011689010

1168GK



L mm	€	Handedness	Quantity	Code
160	30,00	5	3	011689066
200	34,00	5	3	011689070

1168BMK



L mm	€	Handedness	Quantity	Code
160	43,50	3	3	011689036
200	49,00	3	3	011689040

1168GBMK



L mm	€	Handedness	Quantity	Code
160	38,50	3	3	011689266
200	43,50	3	3	011689270

1201E/K



SxAxL mm	€	Handedness	Quantity	Code
0,4x2,5x50	5,20	5	5	012019203
0,4x2,5x75	5,30	5	5	012019206
0,5x3x75	5,40	5	5	012019209
0,5x3x100	5,80	5	5	012019212
0,6x3,5x75	5,80	5	5	012019218
0,6x3,5x100	5,90	5	5	012019221
0,8x4x100	6,00	5	5	012019230
0,8x4x125	6,40	5	5	012019233
0,8x4x150	6,90	5	5	012019236
1,0x5,5x100	7,40	5	5	012019239
1,0x5,5x125	7,90	5	5	012019240
1,0x5,5x150	8,00	5	5	012019242
1,2x6,5x100	8,80	5	5	012019248
1,2x6,5x125	9,10	5	5	012019250
1,2x6,5x150	9,30	5	5	012019251
1,2x8x150	11,90	3	3	012019257
1,2x8x200	12,90	3	3	012019260
1,6x10x200	14,50	3	3	012019266

1201EN/K



SxAxL mm	€	Handedness	Quantity	Code
0,8x4x30	7,40	3	3	012019303
1,2x6,5x30	7,70	3	3	012019306

1202E/K



PHxDxL mm	€	Handedness	Quantity	Code
0x3x60	5,30	5	5	012029203
0x3x100	5,90	5	5	012029206
1x4,5x80	6,80	5	5	012029209
1x4,5x120	7,60	5	5	012029212
2x6x100	9,10	5	5	012029218
2x6x150	9,80	5	5	012029221
3x8x150	12,30	3	3	012029224
4x9,5x200	15,90	3	3	012029227

1202EN/K



PHxDxL mm	€	Handedness	Quantity	Code
1x4,5x30	7,40	3	3	012029303
2x6x30	7,70	3	3	012029306

1204E/K



SxDxL mm	€	Handedness	Quantity	Code
0,4x2,5x60	5,30	5	5	012049103
0,6x3x75	5,40	5	5	012049106
0,5x3x100	5,50	5	5	012049109
0,8x4x100	6,20	5	5	012049112
0,8x4x125	6,50	5	5	012049115
1,0x5x125	7,50	5	5	012049118
1,0x5x150	8,10	5	5	012049121
1,2x6,5x150	8,80	5	5	012049124

1207E TX/K



Type	€	Handedness	Quantity	Code
T5	7,90	5	5	012079105
T6	8,20	5	5	012079106
T7	8,60	5	5	012079107
T8	8,60	5	5	012079108
T9	9,00	5	5	012079109
T10	10,10	5	5	012079110
T15	10,30	5	5	012079115
T20	10,40	5	5	012079120
T25	10,80	5	5	012079125
T27	11,30	5	5	012079127
T30	11,40	5	5	012079130
T40	13,40	2	2	012079140
T45	14,70	2	2	012079145

1208E RTX/K



Type	€	Handedness	Quantity	Code
T9	9,10	5	5	012089109
T10	10,10	5	5	012089110
T15	10,80	5	5	012089115
T20	10,90	5	5	012089120
T25	11,20	5	5	012089125
T27	12,00	5	5	012089127
T30	12,60	5	5	012089130
T40	14,80	2	2	012089140

1209E PZ/K



Type	€	Handedness	Quantity	Code
PZ 0	6,20	5	5	012099200
PZ 1	8,00	5	5	012099203
PZ 2	10,10	5	5	012099206
PZ 3	15,10	3	3	012099209
PZ 4	16,50	3	3	012099212



1209EN-PZ/K



	€	U	Icon
1	7,40	3	012099303
2	7,70	3	012099306

1253



SxAxL mm	€	U	Icon
0,5x3,5x100	11,60	5	012530001

1254



SxAxL mm	€	U	Icon
0,5x3x44	12,70	5	012540001

1260K



SxAxL	€	U	Icon
0,4x2,5x50	7,10	5	012609003
0,4x2,5x75	7,30	5	012609006
0,5x3x75	7,50	5	012609009
0,5x3x100	7,80	5	012609012
0,6x3,5x75	8,00	5	012609018
0,6x3,5x100	8,10	5	012609021
0,8x4x100	8,80	5	012609030
0,8x4x125	9,10	5	012609033
0,8x4x150	9,50	5	012609036
1x5,5x100	10,00	5	012609039
1x5,5x150	11,20	5	012609042
1,5x6,5x100	11,90	5	012609048
1,2x6,5x150	13,10	5	012609051
1,2x8x150	15,50	3	012609057
1,2x8x200	16,00	3	012609060
1,6x10x200	19,40	3	012609066

1260NK



SxAxL mm	€	U	Icon
0,8x4x30	9,20	5	012609103
1,2x6,5x30	10,30	5	012609106

1260EK



SxAxL mm	€	U	Icon
1,2x6,5x150	16,50	3	012609156
1,2x8x175	20,20	3	012609157
1,6x10x200	23,10	2	012609159
2x12x250	27,00	2	012609162

1262K



PHxDxL mm	€	U	Icon
0x3x60	7,50	5	012629003
0x3x100	7,90	5	012629006
1x4,5x80	9,80	5	012629009
1x4,5x120	10,60	5	012629012
2x6x100	11,90	5	012629018
2x6x150	13,30	5	012629021
3x8x150	17,20	3	012629024
4x10x200	21,80	3	012629027

1262NK



PHxDxL	€	U	Icon
1x4,5x30	9,20	5	012629103
2x6x30	10,30	5	012629106

1262EK



PHxDxL mm	€	U	Icon
2x6x150	16,50	3	012629153
3x8x175	20,00	3	012629156
4x10x200	25,00	3	012629159

1264K



SxDxL mm	€	U	Icon
0,5x2,5x60	7,10	5	012649003
0,6x3x75	7,50	5	012649006
0,6x3x100	7,80	5	012649009
0,8x4x100	8,80	5	012649012
0,8x4x125	9,10	5	012649015
1x5x125	10,30	5	012649018
1x5x150	10,90	5	012649021
1,2x6,5x150	13,10	5	012649024

1267TXK



Ø	€	U	Icon
T5	10,40	5	012679005
T6	10,90	5	012679006
T7	11,20	5	012679007
T8	11,60	5	012679008
T9	12,00	5	012679009
T10	12,50	5	012679010
T15	13,40	5	012679015
T20	13,90	5	012679020
T25	15,00	5	012679025
T27	15,50	5	012679027
T30	16,30	5	012679030
T40	18,90	2	012679040
T45	20,80	2	012679045

1268RTXK



Ø	€	U	Icon
T9	13,20	3	012689009
T10	13,50	3	012689010
T15	13,90	3	012689015
T20	15,00	3	012689020
T25	15,30	3	012689025
T27	16,30	3	012689027
T30	16,60	3	012689030
T40	19,20	2	012689040

1269PZK



PZ	€	U	Icon
0	8,50	5	012699000
1	11,20	5	012699001
2	13,30	5	012699002
3	18,50	3	012699003
4	23,40	3	012699004

1269N/PZK



PZ	€	U	Icon
1	9,20	5	012699011
2	10,30	5	012699012

1290K



SxAxL mm	€	🔧	📦
0,4x2,5x50	9,00	5	012909003
0,4x2,5x75	9,20	5	012909006
0,5x3x75	9,50	10	012909009
0,5x3x100	9,90	10	012909012
0,6x3,5x75	10,70	10	012909018
0,6x3,5x100	11,00	10	012909021
0,8x4x100	11,10	10	012909030
0,8x4x125	11,30	10	012909033
0,8x4x150	11,90	10	012909036
1x5,5x100	12,10	10	012909039
1x5,5x150	13,70	10	012909042
1,2x6,5x100	15,00	10	012909048
1,2x6,5x150	15,90	10	012909051
1,2x8x150	19,80	3	012909057
1,2x8x200	20,90	3	012909060
1,6x10x200	24,30	3	012909066

1290NK



SxAxL mm	€	🔧	📦
0,8x4x30	11,60	5	012909103
1,2x6,5x30	12,60	5	012909106

1290K/INOX



SxAxL mm	€	🔧	📦
0,4x2,5x50	11,50	4	012909403
0,5x3x75	11,70	4	012909409
0,8x4x100	12,00	4	012909430
1,0x5,5x150	15,20	4	012909442
1,2x6,5x150	17,40	4	012909451

1292K



PHxDxL mm	€	🔧	📦
0x3x60	8,50	10	012929003
0x3x100	9,70	5	012929006
1x4,5x80	11,60	10	012929009
1x4,5x120	13,00	10	012929012
2x6x100	15,30	10	012929018
2x6x150	16,30	10	012929021
3x8x150	20,70	3	012929024
4x10x200	28,00	3	012929027

1292NK



PHxDxL mm	€	🔧	📦
1x4,5x30	11,20	5	012929103
2x6x30	12,00	5	012929106

1292K/INOX



PHxDxL mm	€	🔧	📦
0x3x60	10,70	4	012929403
1x4,5x80	12,50	4	012929409
2x6x100	15,20	4	012929418

1294K



SxDxL mm	€	🔧	📦
0,5x2,5x60	8,50	5	012949003
0,6x3x75	8,80	5	012949006
0,8x4x100	11,10	5	012949012
1x5x125	13,80	5	012949018

1298RTXK



	€	🔧	📦
T9	18,10	5	012989009
T10	18,40	5	012989010
T15	19,50	5	012989015
T20	19,70	5	012989020
T25	20,20	5	012989025
T27	21,60	5	012989027
T30	22,30	5	012989030
T40	23,80	2	012989040

1299PZK



PZ	€	🔧	📦
0	12,10	5	012999000
1	14,40	5	012999003
2	19,20	5	012999006

1299N/PZK



PZ	€	🔧	📦
1	13,80	5	012999021
2	15,30	5	012999024

1472VW



L mm	€	🔧	📦
200	55,50	1	014720051

1473P



A Max mm	€	🔧	📦
53	43,50	1	014730020

1497BS



L mm	€	🔧	📦
230	27,50	1	014970190

1497SS



L mm	€	🔧	📦
245	25,00	1	014970195



1497RC



1497RC € 89,50 1 014970351

1600Q 8



1600Q 8 € 34,50 1 016000008

1600Q 10



1600Q 10 € 44,50 1 016000010

1603K



mm2 0÷8 € 20,20 5 016039001

1603BK



mm² 0÷8 € 74,50 2 016039010

1651DGTB



A Max mm	€		
150	122,00	1	016510211
200	159,00	1	016510212
300	207,00	1	016510213



1651DGTB/IP

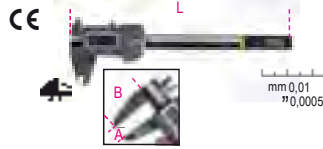

A Max mm 150 € 199,00 1 016510711

1691BM



L m	€		
5	19,00	1	016910205
8	28,50	1	016910208
10	34,50	1	016910210

1691MG



L m	€		
5	16,60	1	016910405
8	22,80	1	016910408
10	25,00	1	016910410

1692



L m	€		
2	9,40	5	016920052
3	11,70	5	016920053
5	16,40	5	016920055
8	23,70	5	016920058

1693

CE



IP54



H mm 100 € 146,00 1 016930020

1729CG



L mm 310 € 28,00 2 017290200

1729DM 450



L mm 450 € 32,50 4 017290450

1741U



Ø mm	2,4	3	3,2	4	4,8
Aluminium	•	•	•	•	•
Stahl	•	•	•	•	•
Edelstahl	•	•	•	•	•

1741U € 55,00 1 017410450



1741B



250 mm

Ø mm	2,4	3,2	4	4,8	5
Aluminium	•	•	•	•	•
Stahl	•	•	•	•	•
Edelstahl	•	•	•		

1741B	€ 46,50	1	017410000
-------	---------	---	-----------

1760K

CE

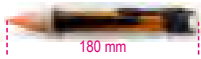

180 mm

CAT III-1000V

1760K	€ 44,50	1	017600140
-------	---------	---	-----------

1762K



Ø mm	€		
2-2,5-3	38,00	2	017629001
3,5-4-4,5			

1771



18 mm

170 mm

1771	€ 11,20	10	017710000
------	---------	----	-----------

1770BM



18 mm

140 mm

L mm	€		
140	15,00	10	017700050

1771BM



18 mm

170 mm

L mm	€		
170	24,30	10	017710050

1771HD



19 mm

190 mm

L mm	€		
190	27,50	5	017710100

1772R



19 mm

125 mm

L mm	€		
125	20,50	5	017720006

1773A



19 mm

180 mm

L mm	€		
180	21,60	10	017730000

1773S



19 mm

190 mm

L mm	€		
190	11,00	1	017730100

1777BMT



17 mm

170 mm

L mm	€		
170	33,00	5	017770050

1777T



16 mm

160 mm

L mm	€		
160	31,00	5	017770030

1778MT



L mm	€		
180	118,00	1	017780055

1783



L mm	€		
215	18,10	5	017830021
240	20,20	5	017830024

1820



L=1,25 m

230V Shuko

1820 30	€ 57,50	1	018200003
30W			
L = 210mm			
1820 60	€ 66,00	1	018200006
60W			
L = 220mm			
1820 80	€ 93,50	1	018200008
80W			
L = 260mm			



1822



1822 120	143,00	1	018220012
120W			
LxA = 250x125 mm			
1822 180	151,00	1	018220018
180W			
LxA = 250x125mm			
1822 320	188,00	1	018220032
320W			
LxA = 250x140mm			

1833XSW



L mm	€		
145	55,50	1	018330011

1833S



L mm	€		
150	44,50	1	018330002

1833M



L mm	€		
162	55,50	1	018330003

1833MW



L mm	€		
160	102,00	1	018330013

Beta

1833L



L mm	€		
196	92,00	1	018330004

1833XL



L mm	€		
300	116,00	1	018330005

1833L/USB



L mm	€		
240	136,00	1	018330054

1836AW



1836AW	83,00	1	018360051
--------	-------	---	-----------

1836B



1836B	151,00	1	018360200
-------	--------	---	-----------

1837F



L mm	€		
460	101,00	1	018370050

1837F/USB



L mm	€		
460	149,00	1	018370060

1838COB



1838COB	109,00	1	018380010
---------	--------	---	-----------

Beta

1838P



CE 1838P € 92,50 1 018380005

1838POCKET



CE 1838POCKET € 78,50 1 018380080

1838SLIM

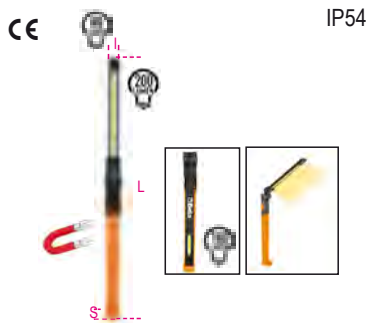

CE 1838SLIM € 84,50 1 018380221

1838SW



CE 1838SW € 113,00 1 018380142

1839BRW



CE 1839BRW € 107,00 1 018390002

1860M



1860M € 110,00 1 018600301

1875SP/K3



1875SP/K3 € 21,70 1 018750010

1949F2



1949F2 € 20,10 1 019490028

1949XS



1949XS € 9,00 25 019490025

6888B1/4

Blisterhalter für Steckschlüssel 1/4"



6888B1/4 € 0,90 50 068880900

6888B3/8

Blisterhalter für Steckschlüssel 3/8"



6888B3/8 € 1,00 50 068880910

6888B1/2

Blisterhalter für Steckschlüssel 1/2"



6888B1/2 € 1,00 50 068880920



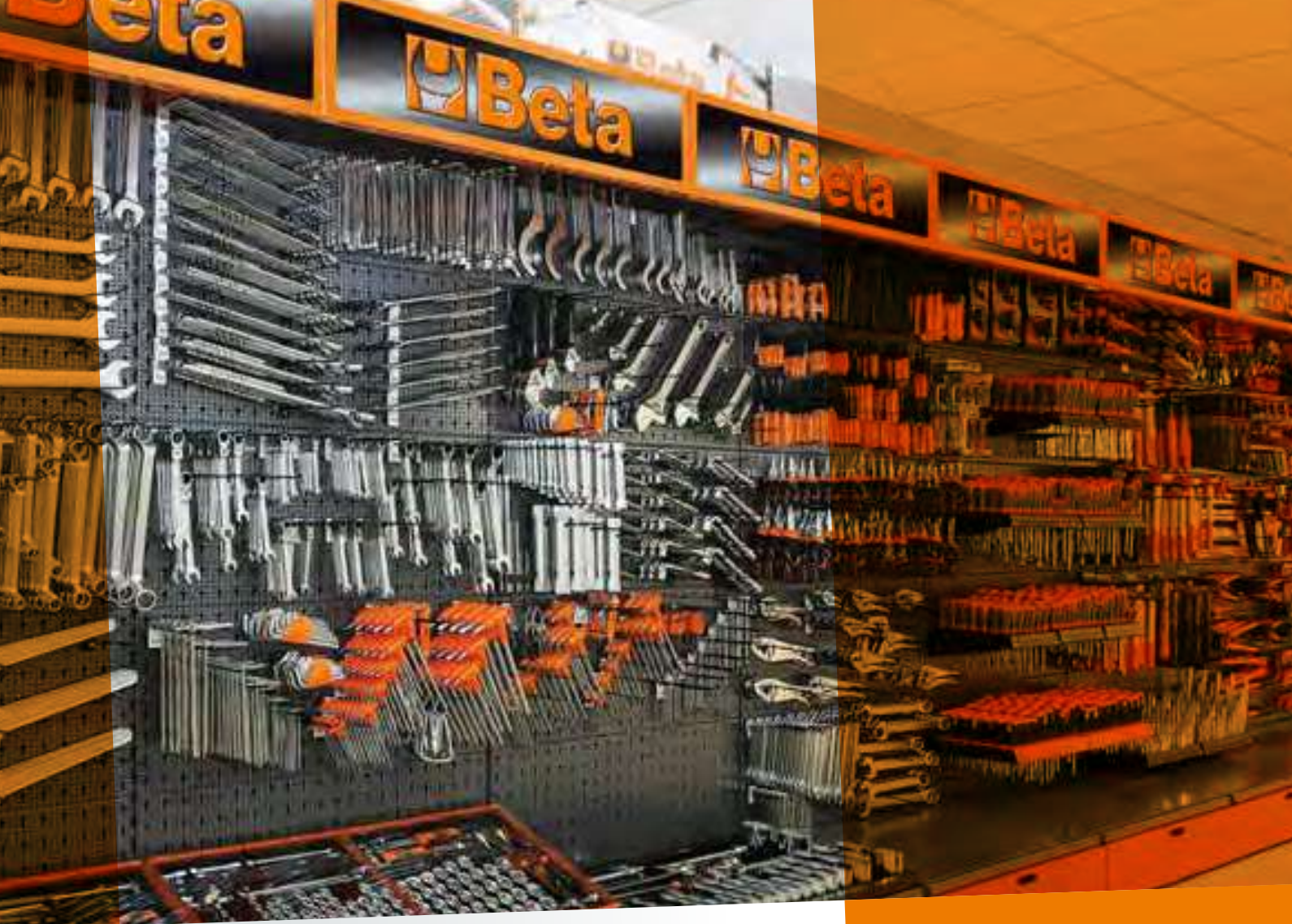

LÖSUNGEN FÜR DIE **VERKAUFSSTELLE**

 **Beta**
SHOP
in Shop



SCHAFFEN SIE IHREN BETA CORNER
www.beta-tools.com/planner3d/

38/DS1

Wandständer mit 75 Schlagwerkzeugen



495x260x332 mm

Ständer mit Sortiment
38/DS1 € 840,00 1 000380701

		n.
30	Ø 2 - 3 - 4 - 5 - 6 mm	5
31	Ø 2 - 3 - 4 - 5 - 6 - 8 - 10 mm	5
32	Ø 3 - 4 - 5 mm	5

Leerer Ständer
38/DVS1 € 131,00 1 000380751

38/DS2

Wandständer mit 65 Schlagwerkzeugen



495x260x332 mm

Ständer mit Sortiment
38/DS2 € 1.590,00 1 000380702

		n.
34	125 - 150 - 175 mm	5
35	100 - 125 - 150 - 200 - 250 - 300 mm	5
36	125 - 150 mm	5
37	150 - 200 mm	5

Leerer Ständer
38/DVS2 € 131,00 1 000380752

942BX/DG

Wandständer mit 43 Sechskant-Steckschlüsseln, kurze Ausführung



330x260x332 mm

Ständer mit Sortiment
942BX/DG € 841,00 1 009420701

		n.
942BX	5 - 5,5 mm	3
	6 - 7 mm	6
	8 - 9 - 10 mm	5
	11 mm	2
	12 mm	3
	13 mm	5

Leerer Ständer
942BX/DVG € 116,00 1 009420751

943BX/DG

Wandständer mit 43 Sechskant-Steckschlüsseln, lange Ausführung



330x260x332 mm

Ständer mit Sortiment
943BX/DG € 904,00 1 009430701

		n.
943BX	5 - 5,5 mm	3
	6 - 7 mm	6
	8 - 9 - 10 mm	5
	11 mm	2
	12 mm	3
	13 mm	5

Leerer Ständer
943BX/DVG € 117,00 1 009430751

944BX/DG

Wandständer mit 43 tiefen Sechskant-Steckschlüsseln mit Griff, lange Ausführung



330x260x332 mm

Ständer mit Sortiment
944BX/DG € 1.046,00 1 009440701

		n.
944BX	5 - 5,5 mm	3
	6 - 7 mm	6
	8 - 9 - 10 mm	5
	11 mm	2
	12 mm	3
	13 mm	5

Leerer Ständer
944BX/DVG € 117,00 1 009440751

943MQ/BG

Wandständer mit 30 Sechskant-Steckschlüsseln



1000 V

330x260x332 mm

Ständer mit Sortiment
943MQ/BG € 735,00 1 009430281

		n.
943MQ	5,5 - 6 - 7 - 8 - 10 - 13 mm	5

Leerer Ständer
943BG-MQ/DV € 117,00 1 009430285

1203/E1P

Wandständer mit 82 Schraubendrehern



495x260x310 mm

Ständer mit Sortiment
1203E/E1P € 551,00 1 012031301

		n.
● 1201	0,4x2,5x50 - 0,5x3x75 - 0,6x3,5x100	7
	0,8x4x100 - 0,8x4x125 mm	6
	1,0x5,5x100 - 1,0x5,5x150 - 1,2x6,5x150 mm	5
⊕ 1202	PH0x3x60 mm	7
	PH1x4,5x80 - PH2x6x100 mm	6
	PH3x8x150 mm	5

Leerer Ständer
1203E/EV1P € 146,00 1 012031351

1203/E5P

Wandständer mit 82 Schraubendrehern



495x260x310 mm

Ständer mit Sortiment
1203E/E5P € 561,00 1 012031305

		n.
⊕ 1202	PH0x3x60 mm	7
	PH1x4,5x80 - PH1x4,5x120	6
	PH2x6x100 - PH2x6x150 mm	5
	PH3x8x150 mm	5
● 1204	0,4x2,5x60 - 0,5x3x100 - 0,8x4x100 mm	7
	1,0x5x125 mm	6
⊕ 1209PZ	PZ0x3x60 mm	7
	PZ1x4,5x80 - PZ2x6x100 mm	6

Leerer Ständer
1203E/EV5P € 146,00 1 012031355

1263/E78

Wandständer mit 78 Schraubendrehern



495x260x310 mm

Ständer mit Sortiment
1263/E78 € 728,00 1 012630510

		n.
● 1260	2,5x75-3x75-3,5x100 mm	7
	4x100-4x125-5,5x100-5,5x150-6,5x150 mm	6
	8x150 mm	4
⊕ 1262	PH0x60 mm	7
	PH1x80-PH2x100 mm	6
	PH3x150	4

Leerer Ständer
1263/EV78 € 135,00 1 012630511

1203/E4P

Wandständer mit 85 Schraubendrehern



495x260x310 mm

Ständer mit Sortiment
1203E/E4P € 530,00 1 012031304

		n.
● 1201	0,4x2,5x50 - 0,5x3x75 - 0,8x4x125 mm	7
	1,0x5,5x100 - 1,0x5,5x150 - 1,2x6,5x150 mm	6
● 1204	0,4x2,5x60 - 0,5x3x100 - 0,8x4x100 mm	7
	1,0x5x125 mm	6
⊕ 1209PZ	PZ0x3x60 mm	7
	PZ1x4,5x80 - PZ2x6x100 mm	6

Leerer Ständer
1203E/EV4P € 146,00 1 012031354

1203/E10P

Wandständer mit 80 Schraubendrehern



495x260x310 mm

Ständer mit Sortiment
1203E/E10P € 755,00 1 012031310

		n.
⊕ 1207TX	T6	4
	T7	3
	T8	7
	T9 - T10 - T15 - T20 - T25	6
⊕ 1208RTX	T27 - T30	3
	T9 - T10	3
	T15 - T20 - T25	6
	T27 - T30	3

Leerer Ständer
1203E/EV10P € 146,00 1 012031360

1263/E74

Wandständer mit 74 Schraubendrehern



495x260x310 mm

Ständer mit Sortiment
1263/E74 € 682,00 1 012630540

		n.
● 1264	2,5x60 mm	7
	3x75 mm	3
	3x100 - 4x100 mm	4
	4x125 - 5x150 mm	2
	5x125 - 6,5x150 mm	4
	⊕ 1262	
⊕ 1262	PH 8x150	3
	PH 3x60 - 3x100 mm	7
	PH 4,5x80 - 4,5x120 mm	6
	PH 6x100 mm	10
	PH 6x150 mm	5

Leerer Ständer
1263/EV74 € 135,00 1 012630541

1263/E85

Wandständer
mit 85 Schraubendrehern



495x260x377 mm

Aussteller mit Sortiment	€	1	012630550	n.
1263/E85	811,00			
● 1260	2,5x50 mm			7
	2,5x75 mm			6
	3x75 - 3x100 - 3,5x100 mm			7
	4x100 - 4x125 - 5,5x125			6
	5,5x150 - 6,5x150 mm			4
	8x150 mm			4
● 1260E	10x200 mm			3
	12x250 mm			2
	4x30 - 6,5x30 mm			6

Leerer Aussteller	€	1	012630551
1263/EV85	135,00		

1263/E70

Wandständer
mit 70 Schraubendrehern



495x260x327 mm

Aussteller mit Sortiment	€	1	012630560	n.
1263/E70	799,00			
⊕ 1262	PH0x60 - PH0x100 mm			7
	PH1x80 - PH1x120 mm			6
	PH2x100 mm			9
	PH2x150 - PH3x150 mm			5
	PH4x200 mm			4
⊕ 1262E	PH2x150 mm			5
	PH3x175 mm			4
⊕ 1262N	PH1x30 - PH2x30 mm			6

Leerer Aussteller	€	1	012630561
1263/EV70	135,00		

1263/E50

Wandständer
mit 50 Schraubendrehern



330x260x269 mm

Aussteller mit Sortiment	€	1	012630570	n.
1263/E50	419,00			
● 1264	2,5x60 - 3x75 - 3x100 mm			7
	4x100 - 4x125 - 5x125 - 5x150 mm			6
	6,5x150 mm			5

Leerer Aussteller	€	1	012630571
1263/EV50	117,00		

1263/E62

Wandständer
mit 62 Schraubendrehern



495x260x257 mm

Aussteller mit Sortiment	€	1	012630590	n.
1263/E62	772,00			
⊕ 1267TX	T5			5
	T6			6
	T7			5
	T8			6
	T9			5
	T10 - T15 - T20			6
	T25			5
	T27 - T30			4
	T40 - T45			2

Leerer Aussteller	€	1	012630591
1263/EV62	135,00		

1263/E39

Wandständer
mit 39 Schraubendrehern



330x260x257 mm

Aussteller mit Sortiment	€	1	012630595	n.
1263/E39	547,00			
⊕ 1268RTX	T9x60 - T10x80 - T15x80			6
	T20x100 - T25x100 mm			4
	T27x115 mm			3
	T30x115 mm			2
	T40x130 mm			

Leerer Aussteller	€	1	012630596
1263/EV39	117,00		

1263/E40

Wandständer
mit 40 Schraubendrehern



330x260x327 mm

Aussteller mit Sortiment	€	1	012630580	n.
1263/E40	485,00			
⊕ 1269	PZ0x60 mm			7
	PZ1x80 mm			6
	PZ2x100 - PZ3x150 - PZ4x200 mm			5
⊕ 1269N	PZ1x30 - PZ2x30 mm			6

Leerer Aussteller	€	1	012630581
1263/EV40	117,00		

1273MQ/E1

Wandständer mit 40 Schraubendrehern



△ 1000 V

330x260x332 mm

Ständer mit Sortiment
1273MQ/E1 € 616,00 1 012730312

Code	Specification	n.
1272MQ	PH0x60 - PH1x80 mm	5
	PH2x100 mm	3
	PH3x150 mm	2
1274MQ	3x100 - 4x100 - 5,5x125 - 6,5x150 mm	5
	8x175 mm	3
	10x200 mm	2

Leerer Ständer
1273BG-MQ/DV € 117,00 1 012730651

1273MQ/E4

Wandständer mit 43 Schraubendrehern



△ 1000 V

330x260x332 mm

Ständer mit Sortiment
1273MQ/E4 € 835,00 1 012730315

Code	Specification	n.
1272MQF	4,5x80 - 6x100 mm	3
1274MQF	3,5x100 - 4,5x100 - 5,5x125 - 6,5x150 mm	3
1275MQ/C	4,5x80 - 6x100 mm	5
1276MQ/C	4,5x80 - 6x100 mm	5
1279MQ/F	4,5x80 mm	3
	6x100 mm	2

Leerer Ständer
1273BG-MQ/DV4 € 117,00 1 012730655

1293BX/DA

Wandständer mit 90 Schraubendrehern



495x260x332 mm

Ständer mit Sortiment
1293BX/DA € 1.085,00 1 012930701

Code	Specification	n.
1290	3x75 - 3,5x100 - 4x100 - 4x125	7
	5,5x100 - 5,5x150 mm	6
	6,5x150 mm	3
	8x150 mm	2
	10x200 mm	2
1290N	4x30 - 6,5x30 mm	3
1292	PH0x60 - PH1x80 mm	7
	PH2x100 mm	6
	PH3x150 mm	5
1292N	PH1x30 - PH2x30 mm	3

Leerer Ständer
1293BX/DVA € 135,00 1 012930751

1293BX/DD

Wandständer mit 48 Schraubendrehern



330x260x332 mm

Ständer mit Sortiment
1293BX/DD € 515,00 1 012930704

Code	Specification	n.
1294	2,5x60 - 3x75 - 3x100 - 4x100	7
	4x150 - 5x125 mm	6
	6,5x150 mm	6

Leerer Ständer
1293BX/DVD € 117,50 1 012930754

1293BX/DE

Wandständer mit 42 Schraubendrehern



330x260x332 mm

Ständer mit Sortiment
1293BX/DE € 767,00 1 012930705

Code	Specification	n.
1299PZ	PZ0x60 - PZ1x80 mm	7
	PZ2x100 mm	6
	PZ3x150 - PZ4x200 mm	5
1299N/PZ	PZ1x30 - PZ2x30 mm	6

Leerer Ständer
1293BX/DVE € 117,50 1 012930755

1293BX/DF

Wandständer mit 59 Schraubendrehern



330x260x332 mm

Ständer mit Sortiment
1293BX/DF € 1.015,00 1 012930706

Code	Specification	n.
1297TX	T6 - T8 - T10 - T15 - T20 - T25	7
	T27 - T30	6
	T40	5

Leerer Ständer
1293BX/DVF € 117,50 1 012930756

C68
Ausstellungswand Beta, leer



1000x560x2200 mm

		€		
C68/1	1 m	2.495,00	1	068000001
C68/2	2 m	4.350,00	1	068000002
C68/3	3 m	6.200,00	1	068000003
C68/4	4 m	8.050,00	1	068000004
C68/5	5 m	9.890,00	1	068000005
C68/6	6 m	11.750,00	1	068000006
C68/7	7 m	13.600,00	1	068000007
C68/8	8 m	15.450,00	1	068000008
C68/9	9 m	17.310,00	1	068000009
C68/10	10 m	19.150,00	1	068000010

C68N
Ausstellungswand Beta, leer



1000x560x2200 mm

		€		
C68N/1	1 m	2.150,00	1	068000031
C68N/2	2 m	4.010,00	1	068000032
C68N/3	3 m	5.850,00	1	068000033
C68N/4	4 m	7.710,00	1	068000034
C68N/5	5 m	9.540,00	1	068000035
C68N/6	6 m	11.410,00	1	068000036
C68N/7	7 m	13.250,00	1	068000037
C68N/8	8 m	15.110,00	1	068000038
C68N/9	9 m	16.950,00	1	068000039
C68N/10	10 m	18.810,00	1	068000040

C68 G
Ausstellungsgondel



1000x1120x1600 mm

		€		
C68G/1	1 m	2.275,00	1	068000051
C68G/2	2 m	4.200,00	1	068000052
C68G/3	3 m	6.100,00	1	068000053
C68G/4	4 m	8.010,00	1	068000054

C88 R/1
Ausstellungswand Robur, leer



1000x560x2200 mm

		€		
C88R/1	1 m	2.495,00	1	088000001

C88NR/1
Ausstellungswand Robur, leer



1000x560x2200 mm

		€		
C88NR/1	1 m	2.150,00	1	088000031

C88VE
Schale für Ausstellungswand Art. C88

Zur Aufnahme von Kettenspulen Art. 8120



		€		
C88VE		266,00	1	088000120

C88SE
Ständer für Kettenspulen (Kettentyp "Genovese")



		€		
C88SE		643,00	1	088000130

1700x600x600 mm



6888

Haken für Aussteller C60 - C61 - C68 - C88



	€	📦	🚚
6888S1	5,20	10	068880011
6888S2	5,20	10	068880012
6888D1	8,20	5	068880021
6888D2	8,20	5	068880022
6888D4	8,40	5	068880024
6888D5	8,40	5	068880025
6888T1	11,70	5	068880031
6888T2	11,70	5	068880032
6888CT	21,70	1	068880044
6888B	77,50	1	068880100
6888GA	25,50	3	068880120
6888S-1/4	46,50	1	068880605
6888S-3/8	46,50	1	068880610

6800 VE

Vitrine für Ausstellungswand Art. C68 und Art. C68 R/1



	€	📦	🚚
6800VE/1 1 m	1.245,00	1	068000401
6800VE/2 2 m	1.900,00	1	068000402
6800VE/3 3 m	2.550,00	1	068000403
6800VE/4 4 m	3.210,00	1	068000404
6800VE/5 5 m	3.870,00	1	068000405



	€	📦	🚚
6800AE	249,00	1	068000145
6800AI	514,00	1	068000140
6800AD/P	874,00	1	068000143

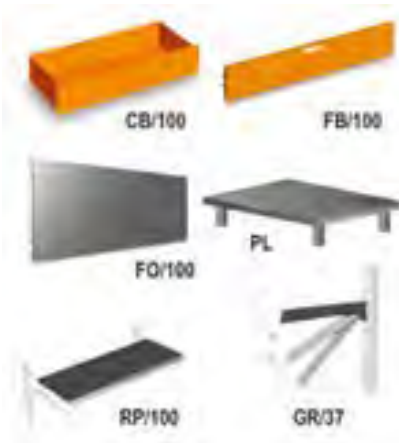

	€	📦	🚚
6800CB/100	288,00	1	068000104
6800FB/100	102,00	1	068000109
6800FO/100	69,00	1	068000108
6800PL	292,00	1	068000137
6800RP/100	92,00	1	068000150
6800GR/37	39,00	1	068000159



	€	📦	🚚
6800PM/40	92,00	1	068000171
6800PM/80	125,00	1	068000172

6600 M/14

Werkzeugsortiment, 154-teilig, mit Haken ohne Tafel

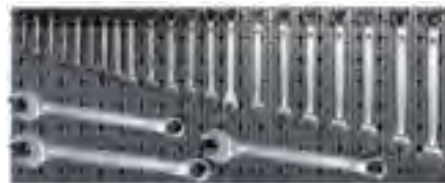

	€	📦	🚚
6600 M/14	2.720,00	1	066000014

6600 M/22

Werkzeugsortiment, 108teilig, mit Haken ohne Tafel



	€	📦	🚚
6600 M/22	1.840,00	1	066000022

6600 M/27

Werkzeugsortiment, 25teilig, mit Haken ohne Tafel



	€	📦	🚚
6600 M/27	1.280,00	1	066000027

6600 M/29

Werkzeugsortiment, 173-teilig, mit Haken ohne Tafel



	€	📦	🚚
6600 M/29	2.400,00	1	066000029

6600 M/33

Werkzeugsortiment, 37-teilig, mit Haken ohne Tafel



	€	📦	🚚
6600 M/33	2.045,00	1	066000033

6600 M/40

Werkzeugsortiment, 100teilig,
mit Haken ohne Tafel



6600 M/40 € 3.040,00 1 066000040

6600 M/42

Werkzeugsortiment, 65-teilig,
mit Haken ohne Tafel



6600 M/42 € 1.965,00 1 066000042

6600 M/44

Werkzeugsortiment, 48-teilig,
mit Haken ohne Tafel

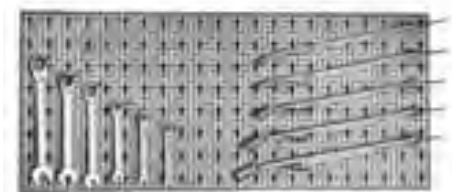

6600 M/44 € 1.705,00 1 066000044

6600 M/47

Werkzeugsortiment, 65teilig,
mit Haken ohne Tafel



6600 M/47 € 1.825,00 1 066000047

6600 M/51

Werkzeugsortiment, 257teilig,
mit Haken ohne Tafel



6600 M/51 € 3.250,00 1 066000051

6600 M/52

Werkzeugsortiment, 176teilig,
mit Haken ohne Tafel



6600 M/52 € 2.125,00 1 066000052

6600 M/58

Werkzeugsortiment, 150teilig,
mit Haken ohne Tafel



6600 M/58 € 2.310,00 1 066000058

6600 M/59

Werkzeugsortiment, 220-teilig,
mit Haken ohne Tafel



6600 M/59 € 2.460,00 1 066000059

6600 M/61

Werkzeugsortiment, 71teilig,
mit Haken ohne Tafel



6600 M/61 € 2.940,00 1 066000061

6600 M/62

Werkzeugsortiment, 28-teilig,
mit Haken ohne Tafel



6600 M/62 € 690,00 1 066000062

6600 M/63

Werkzeugsortiment, 110teilig,
mit Haken ohne Tafel



6600 M/63 € 2.670,00 1 066000063

6600 M/73

Werkzeugsortiment, 68teilig,
mit Haken ohne Tafel



6600 M/73 € 1.740,00 1 066000073

6600 M/112

Werkzeugsortiment, 329teilig,
mit Haken ohne Tafel



6600 M/112 € 2.870,00 1 066000112

6600 M/116

Werkzeugsortiment, 306teilig,
mit Haken ohne Tafel



6600 M/116 € 2.690,00 1 066000116

6600 M/120

Werkzeugsortiment, 163teilig,
mit Haken ohne Tafel



6600 M/120 € 1.945,00 1 066000120

6600 M/125

Werkzeugsortiment, 133teilig,
mit Haken ohne Tafel



6600 M/125 € 1.675,00 1 066000125

6600 M/126

Werkzeugsortiment, 58teilig,
mit Haken ohne Tafel



6600 M/126 € 1.033,00 1 066000126

6600 M/131

Werkzeugsortiment, 92teilig,
mit Haken ohne Tafel



6600 M/131 € 3.210,00 1 066000131

6600 M/174

Werkzeugsortiment, 13-teilig, mit Haken ohne
Tafel



6600 M/174 € 4.870,00 1 066000174

6600 M/175

Werkzeugsortiment, 12-teilig,
mit Haken ohne Tafel



6600 M/175 € 3.520,00 1 066000175

6600 M/217

Werkzeugsortiment, 74-teilig,
mit Haken ohne Tafel



6600 M/217 € 3.180,00 1 066000217

6600 M/218

Werkzeugsortiment, 58-teilig,
mit Haken ohne Tafel



6600 M/218 € 1.680,00 1 066000218

6600 M/222

Werkzeugsortiment, 74-teilig,
mit Haken ohne Tafel



6600 M/222 € 2.570,00 1 066000222

6600 M/223

Werkzeugsortiment, 58-teilig,
mit Haken ohne Tafel



6600 M/223 € 2.190,00 1 066000223

6600 M/230

Werkzeugsortiment, 78teilig,
mit Haken ohne Tafel



6600 M/230 € 2.810,00 1 066000230

6600 M/236

Werkzeugsortiment, 31teilig,
mit Haken ohne Tafel



6600 M/236 € 1.585,00 1 066000236

6600 M/241

Werkzeugsortiment, 43teilig,
mit Haken ohne Tafel



6600 M/241 € 1.360,00 1 066000241

6600 M/242

Werkzeugsortiment, 91-teilig,
mit Haken ohne Tafel



6600 M/242 € 3.250,00 1 066000242

6600 M/253

Werkzeugsortiment, 60-teilig,
mit Haken ohne Tafel



6600 M/253 € 2.275,00 1 066000253

6600 M/311

Werkzeugsortiment, 114teilig,
mit Haken ohne Tafel



6600 M/311 € 1.385,00 1 066000311

6600 M/315

Werkzeugsortiment, 149teilig,
mit Haken ohne Tafel



6600 M/315 € 2.300,00 1 066000315

6600 M/320

Werkzeugsortiment, 98teilig,
mit Haken ohne Tafel



6600 M/320 € 1.995,00 1 066000320

6600 M/326

Werkzeugsortiment, 155teilig,
mit Haken ohne Tafel



6600 M/326 € 1.610,00 1 066000326

6600 M/327

Werkzeugsortiment, 101teilig,
mit Haken ohne Tafel

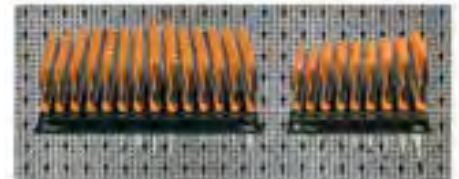

6600 M/327 € 1.315,00 1 066000327

6600 M/330

Werkzeugsortiment, 110teilig,
mit Haken ohne Tafel



6600 M/330 € 1.083,00 1 066000330

6600 M/371

Werkzeugsortiment, 162-teilig,
mit Haken ohne Tafel



6600 M/371 € 1.305,00 1 066000371

6600 M/380

Werkzeugsortiment, 71-teilig,
mit Haken ohne Tafel



6600 M/380 € 840,00 1 066000380

6600 M/406

Werkzeugsortiment, 107-teilig,
mit Haken ohne Tafel



6600 M/406 € 1.405,00 1 066000406

6600 M/417

Werkzeugsortiment, 43-teilig,
mit Haken ohne Tafel



6600 M/417 € 1.220,00 1 066000417

6600 M/423

Werkzeugsortiment, 30-teilig, mit Haken ohne
Tafel



6600 M/423 € 1.210,00 1 066000423

6600 M/424

Werkzeugsortiment, 36-teilig, mit Haken ohne
Tafel



6600 M/424 € 1.285,00 1 066000424

6600 M/427

Werkzeugsortiment, 24-teilig,
mit Haken ohne Tafel



6600 M/427 € 1.315,00 1 066000427

6600 M/430

Werkzeugsortiment, 29-teilig,
mit Haken ohne Tafel



6600 M/430 € 1.280,00 1 066000430

6600 M/440

Werkzeugsortiment, 140-teilig,
mit Haken ohne Tafel



6600 M/440 € 2.425,00 1 066000440

6600 M/456

Werkzeugsortiment, 41-teilig,
mit Haken ohne Tafel



6600 M/456 € 1.740,00 1 066000456

6600 M/465

Werkzeugsortiment, 36-teilig, mit Haken ohne
Tafel



6600 M/465 € 2.355,00 1 066000465

6600 M/480

Werkzeugsortiment, 18-teilig,
mit Haken ohne Tafel

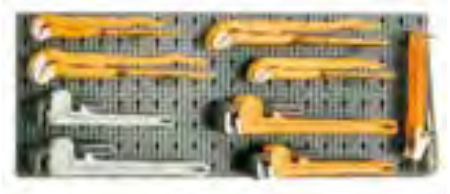

6600 M/480 € 1.400,00 1 066000480

6600 M/485

Werkzeugsortiment, 12-teilig,
mit Haken ohne Tafel

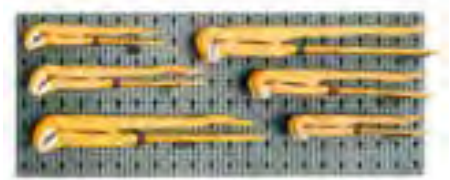

6600 M/485 € 1.010,00 1 066000485

6600 M/510

Werkzeugsortiment, 16teilig,
mit Haken ohne Tafel



6600 M/510 € 1.395,00 1 066000510

6600 M/532

Werkzeugsortiment, 24teilig,
mit Haken ohne Tafel



6600 M/532 € 1.135,00 1 066000532

6600 M/534

Werkzeugsortiment, 51teilig,
mit Haken ohne Tafel



6600 M/534 € 1.815,00 1 066000534

6600 M/542

Werkzeugsortiment, 53teilig,
mit Haken ohne Tafel



6600 M/542 € 1.127,00 1 066000542

6600 M/548

Werkzeugsortiment, 37-teilig,
mit Haken ohne Tafel



6600 M/548 € 1.030,00 1 066000548

6600 M/561

Werkzeugsortiment, 60teilig, mit Haken ohne
Tafel



6600 M/561 € 1.480,00 1 066000561

6600 M/583

Werkzeugsortiment, 22teilig,
mit Haken ohne Tafel



6600 M/583 € 1.032,00 1 066000583

6600 M/643

Werkzeugsortiment, 90-teilig,
mit Haken ohne Tafel



6600 M/643 € 2.490,00 1 066000643

6600 M/650

Werkzeugsortiment, 28teilig,
mit Haken ohne Tafel

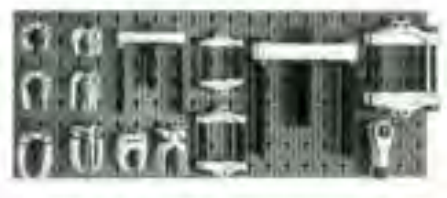

6600 M/650 € 3.040,00 1 066000650

6600 M/657

Werkzeugsortiment, 17teilig, mit Haken ohne
Tafel



6600 M/657 € 2.465,00 1 066000657

6600 M/658

Werkzeugsortiment, 14teilig,
mit Haken ohne Tafel



6600 M/658 € 2.750,00 1 066000658



6600 M/716

Werkzeugsortiment, 64teilig,
mit Haken ohne Tafel



6600 M/716 € 3.000,00 1 066000716

6600 M/813

Werkzeugsortiment, 25-teilig, mit Haken ohne
Tafel



6600 M/813 € 1.405,00 1 066000813

6600 M/842

Werkzeugsortiment, 36-teilig, mit Haken ohne
Tafel



6600 M/842 € 1.825,00 1 066000842

6600 M/852

Sortiment aus 560 Schleifmitteln
mit Haken ohne Tafel



6600 M/852 € 1.760,00 1 066000852

6600 M/856

Sortiment aus 560 Schleifmitteln
mit Haken ohne Tafel



6600 M/856 € 1.850,00 1 066000856

6600 M/857

Sortiment aus 560 Schleifmitteln
mit Haken ohne Tafel



6600 M/857 € 1.950,00 1 066000857

6600 M/871

Sortiment aus 120 Schleifmitteln
mit Haken ohne Tafel



6600 M/871 € 789,00 1 066000871



6600 M/878

Sortiment aus 100 Schleifmitteln
mit Haken ohne Tafel



6600 M/878 € 741,00 1 066000878

6600 M/881

Sortiment aus 410 Schleifmitteln
mit Ausstellerschale

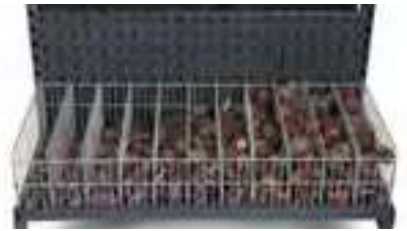

6600 M/881 € 2.195,00 1 066000881



8600 R/11

Sortiment aus 374 Seilzubehörteilen,
mit Haken ohne Tafel



8600 R/11 € 1.925,00 1 086000011

8600 R/12

Sortiment aus 259 Seilzubehörteilen,
mit Haken ohne Tafel

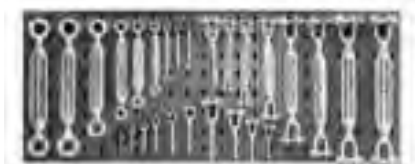

8600 R/12 € 1.885,00 1 086000012

8600 R/13

Sortiment aus 230 Seilzubehörteilen,
mit Haken ohne Tafel



8600 R/13 € 1.590,00 1 086000013

8600 R/113

Sortiment aus 1862 Seilzubehörteilen,
mit Haken ohne Tafel



8600 R/113 € 2.225,00 1 086000113

8600 R/114

Sortiment aus 1045 Seilzubehörteilen,
mit Haken ohne Tafel



8600 R/114 € 2.185,00 1 086000114

8600 R/225

Sortiment aus 64 Zubehörteilen GRAD 8
mit Haken ohne Tafel



8600 R/225 € 1.495,00 1 086000225

8600 R/412

Sortiment aus 348 Seilzubehörteilen,
EDELSTAHL,
mit Haken ohne Tafel



8600 R/412 € 2.210,00 1 086000412

8600 R/511

Sortiment mit 11 Kettenspulen (Kettentyp
"Genovese")
mit Ausstellungscha



8600 R/511 € 1.840,00 1 086000511

8600 R/601

Sortiment aus 50 Verankerungsratschen mit
Gittern, Ablage und Haken ohne Tafel



8600 R/601 € 1.210,00 1 086000601
C88/R601 € 360,00 1 088000160

8600 R/611

Sortiment aus 52 Hebebändern
mit Gittern ohne Tafel



8600 R/611 € 961,00 1 086000611
C88/R611 € 210,00 1 088000161



SICHERHEITSSCHUHE



Durchtrittsichere Einlage



Beständig gegen wiederholtes Durchbiegen > 60.000



Zehenschutzkappe



Kontakthitzebeständige Sohle (300 °C/min)



Antistatisch



Amagnetisch, ohne jegliche Metallteile



Energieaufnahme im Fersenbereich



Konstante Ableitung elektrostatischer Ladungen vom Körper zum Boden



Öl-, kohlenwasserstoff- und lösungsmittelbeständige Sohle



Breite Passform (11) für mehr Komfort



Rutschfeste Sohle



Kälteisoliertes Schuhwerk (-20 °C)

NORMEN UND KATEGORIEN

Vor der Verwendung überprüfen, dass die Schuhe ihre Nutzungsansprüche erfüllen und die Schutzkategorie hinsichtlich Arbeitsort und Arbeitstyp korrekt ist. Die von Beta Utensili hergestellten Sicherheitsschuhe entsprechen den geltenden EUROPÄISCHEN NORMEN. Laut Gesetz ist der Arbeitsgeber für die Angemessenheit der je nach vorhandenem Risikotyp einzusetzenden PSA verantwortlich (Eigenschaft der PAS und Zugehörigkeitskategorie).

VERALTUNG

Aufgrund zahlreicher Faktoren (Feuchtigkeit am Lagerort und Veränderung der Materialstruktur im Laufe der Zeit) kann die Dauer der Lagerfähigkeit des Schuhs nicht mit Sicherheit bestimmt werden. Generell gilt: für ganz aus Polyurethan gefertigte oder eine Polyurethansohle aufweisende Schuhe ist von einer maximalen Lebensdauer von drei Jahren ab Produktionsdatum auszugehen. Für ganz aus PVC bestehende Schuhe kann eine fünfjährigen Lebensdauer angenommen werden, während Schuhe mit Oberteil aus Leder, Schuhe aus Gummi, Thermoplasten und EVA eine Lebensdauer von maximal zehn Jahren ab Produktionsdatum haben können. Diese Frist gilt für neue, unter kontrollierten Bedingungen aufbewahrte Schuhe in der Verpackung, wobei starke Temperaturschwankungen und hohe Feuchtigkeit zu vermeiden sind.

EUROPÄISCHE RECHTSVORSCHRIFTEN UND ENTSPRECHENDE BEDEUTUNG EN ISO 20345:2011 - EN ISO 20347:2012

NORMENKONFORMITÄT EN ISO 20345:2011

Die Norm spezifiziert die Grundanforderungen und zusätzliche Anforderungen (fakultativ) für Sicherheitsschuhe für allgemeine Anwendungen. Die der Norm EN ISO 20345:211 entsprechenden Schuhe sind durch den Buchstaben "S" (Safety = Sicherheit) gekennzeichnet, mit einer Stoßfestigkeit von 200 Joule.

NORMENKONFORMITÄT EN ISO 20347:2012

Die Norm spezifiziert die Grundanforderungen und Zusatzanforderungen (fakultativ) für Arbeitsschuhe, die keinen mechanischen Risiken ausgesetzt sind (Stoß oder Kompression). Die der Norm EN ISO 20347:2012 entsprechenden Schuhe sind durch den Buchstaben "O" (Occupational = Berufsschuh) gekennzeichnet. Sie haben ähnliche Eigenschaften wie die vorab aufgeführten Schuhe, mit den beiden Unterschieden, dass sie über keine Zehenschutzkappen und durchtrittsichere Zwischensohlen verfügen.

EUROPÄISCHE RECHTSVORSCHRIFTEN UND ENTSPRECHENDE BEDEUTUNG EN ISO 20345:2022 - EN ISO 20347:2022

NORMENKONFORMITÄT EN ISO 20345:2022

Die Norm spezifiziert die Grundanforderungen und zusätzliche Anforderungen (fakultativ) für Sicherheitsschuhe für allgemeine Anwendungen. Die der Norm EN ISO 20345:211 entsprechenden Schuhe sind durch den Buchstaben "S" (Safety = Sicherheit) gekennzeichnet, mit einer Stoßfestigkeit von 200 Joule.

NORMENKONFORMITÄT EN ISO 20347:2022

Die Norm spezifiziert die Grundanforderungen und Zusatzanforderungen (fakultativ) für Arbeitsschuhe, die keinen mechanischen Risiken ausgesetzt sind (Stoß oder Kompression). Die der Norm EN ISO 20347:2022 entsprechenden Schuhe sind durch den Buchstaben "O" (Occupational = Berufsschuh) gekennzeichnet. Sie haben ähnliche Eigenschaften wie die vorab aufgeführten Schuhe, mit den beiden Unterschieden, dass sie über keine Zehenschutzkappen und durchtrittsichere Zwischensohlen verfügen. Außer den obligatorischen Grundanforderungen gemäß der Norm EN ISO 20345:2022, können die Schuhe auch Zusatzanforderungen erfüllen. Diese Anforderungen müssen mit Symbolen oder Klassen identifiziert und auf dem an der Schuhzunge angebrachten Etikett der Schuhzunge angegeben werden.

Informationen für Schuhe mit durchtrittsicherer Einlage

Der Durchtrittschutz dieses Schuhs wurde im Labor mit Standardnägeln und -kräften gemessen. Nägel mit geringerem Durchmesser sowie höhere statische oder dynamische Lasten steigern die Durchtrittgefahr. In solchen Situationen sind weitere Sicherheitsmaßnahmen in Betracht zu ziehen. Derzeit sind für PSA-Schuhe drei verschiedene, durchtrittsichere Einlagen erhältlich. Sie können metallisch oder nichtmetallisch sein, und sie sind auf Grundlage einer von der Art der Arbeitstätigkeit abhängigen Risikobewertung zu wählen. Alle Einlagen bieten Durchtrittschutz, aber jede einzelne hat darüber hinaus weitere Vor- bzw. Nachteile wie etwa die folgenden:

- **Metallische Durchtrittschutz-Einlage:** Der Durchtrittschutz wird weniger durch die Beschaffenheit des durchstechenden Gegenstands (wie beispielsweise Durchmesser, Form bzw. Spitze/Schärfe) beeinträchtigt. Aufgrund der produktionstechnischen Größenbeschränkungen deckt sie jedoch nicht die gesamte Schuhsohle ab.
- **Nichtmetallische Durchtrittschutz-Einlage:** Kann im Vergleich zur Metalleinlage leichter und flexibler sein und eine größere Fläche abdecken, aber die Durchtrittbeständigkeit kann je nach Beschaffenheit des durchstechenden Gegenstands (wie beispielsweise Durchmesser, Form bzw. Spitze/Schärfe) stärker variieren. Der Typ PS kann einen angemesseneren Schutz gegen Gegenstände mit kleinerem Durchmesser bieten als der Typ PL.

EN ISO 20345:2011 - EN ISO 20347:2012

GRUNDANFORDERUNGEN + ZUSATZANFORDERUNGEN SCHUHE

KLASSIFIZIERUNG DER SCHUHE

Klasse I: Schuhe aus Leder oder anderen Materialien ausgenommen ganz aus Gummi sowie ganz aus Polymeren bestehende Schuhe.

Klasse II: Ganz aus Gummi bestehende (das heißt vollständig vulkanisierte) Schuhe und ganz aus Polymeren bestehende (das heißt vollständig spritzgegossene) Schuhe).

GRUNDANFORDERUNGEN

- **Ganzer Schuh:** Höhe des Oberteils; Fersenbereich; Leistungen des Sohlenaufbaus (Aufbau und Beständigkeit gegen die Ablösung der Sohle vom Oberteil); Zehenschutz und Merkmale der Zehenschutzkappe (außer EN ISO 20347); Rutschhemmung.
- **Oberteil:** Merkmale der Oberteilmaterialien, Futter, Lasche, Innensohle (Reiß- und Abriebfestigkeit, Traktionsmerkmale, Wasserdampfdurchlässigkeit, pH-Wert, Wasseraufnahme und -abgabe von Innensohle und Einlegesohle).
- **Sohle:** Konstruktion und Reiß- sowie Abriebfestigkeit, Biegefestigkeit, Beständigkeit gegen Hydrolyse, die Ablösung von Sohlenschichten und gegen Öle und Kohlenwasserstoffe.

SCHUTZKLASSE	EN ISO 20345:2011				EN ISO 20347:2012				EN ISO 20345:2011		EN ISO 20347:2012		ERFORDERLICHE MINDESTWERTE	
	SB	S1	S2	S3	OB	O1	O2	O3	S4	S5	O4	O5		
	Geschlossener Fersenbereich	0	X	X	X	0	X	X	X	X	X	X	X	
	Stoßfestigkeit der Zehenschutzkappe 200 Joule	X	X	X	X	-	-	-	-	X	X	-	-	
A	Antistatische Schuhe	0	X	X	X	0	X	X	X	X	X	X	X	Elektrischer Widerstand > 100 kΩ, ≤ 1000 MΩ
E	Energieaufnahme im Fersenbereich	0	X	X	X	0	X	X	X	X	X	X	X	> 20 Joules
WRU	Wasserdurchtritt und Wasseraufnahme	0	-	X	X	0	-	X	X	-	-	-	-	Durchtritt: < 0.2 g x 60 min Aufnahme: < 30% x 60 min.
P	Durchtrittsichere Sohle	0	0	-	X	0	0	-	X	0	X	0	X	> 1100 N
CI	Kälteisolierung	0	0	0	0	0	0	0	0	0	0	0	0	Temp. Reduzierung Sohleninnenfläche: < 10° C
HI	Wärmeisolierung	0	0	0	0	0	0	0	0	0	0	0	0	Temp. Erhöhung Sohleninnenfläche: < 22° C
HRO	Beständigkeit der Sohle gegenüber Kontaktwärme	0	0	0	0	0	0	0	0	0	0	0	0	Beständig bis zu 300 °C
WR	Wasserdichtigkeit des Schuhs	0	0	0	0	0	0	0	0	-	-	-	-	Aufnahme: < 3 cm ²
FO	Kraftstoffbeständigkeit der Sohle	0	X	X	X	0	0	0	0	X	X	0	0	Volumenerhöhung der Sohle <12%
SRC	Rutschhemmung der Sohle	X	X	X	X	X	X	X	X					Anforderung SRA + SRB

X	Obligatorische Anforderung der Schutzkategorie
O	Fakultative Anforderung zusätzlich zu den Pflichtanforderungen, sofern in der Kennzeichnung angegeben
-	Nicht obligatorische Anforderung, Schuhkennzeichnung kontrollieren

Antistatische Schuhe:

Die antistatischen Schuhe werden benutzt, wenn die Notwendigkeit besteht, die Ansammlung von elektrostatischen Aufladungen auf ein Minimum zu reduzieren, um die Verbrennungsgefahr von entflammaren Stoffen und Dämpfen auszuschließen, und wenn die Gefahr von Stromschlag durch unter Spannung stehende Elemente besteht. Die antistatischen Schuhe liefern keinen Schutz gegen Stromschlag, da sie nur einen elektrischen Widerstand zwischen dem Boden und dem Fuß herstellen. Falls die Gefahr von Stromschlag nicht gänzlich ausgeschlossen werden kann, müssen zusätzliche Maßnahmen getroffen werden, die Teil eines Arbeitsunfallverhütungsprogramm sein sollten. Zur Wahrung der antistatischen Anforderungen dürfen keine Änderungen an den Schuhen vorgenommen werden.

Elektrisch isolierende Schuhe:

Die elektrisch isolierenden Schuhe bieten elektrischen Schutz vor versehentlichem Kontakt mit Spannungen bis zu 1000 V, vorausgesetzt, dass die Anwendungsbedingungen den elektrischen Widerstand mit der Beeinflussung von Feuchtigkeit nicht ändern oder beeinträchtigen. Es wird spezifiziert, dass der elektrische Widerstand sich nur auf die Schuhsohle und nicht auf das Obermaterial bezieht.

Elektrische Klassen der Schuhe:

Klasse 00 500V CA oder 750V CC

Klasse 0 1000V CA oder 1500V CC

Ableitende Schuhe für EPA-Bereiche:

Die ableitenden Schuhe sind spezifisch für (ESDS) EPA-Bereiche ausgelegt und ermöglichen, dass die am Körper der Person, die sie trägt, vorhandenen elektrostatischen Aufladungen kontinuierlich und kontrolliert abgeleitet werden, um so die elektronischen Komponenten und Geräte vor elektrostatischen Erscheinungen zu schützen. Der Bezugswert des Erdwiderstands gemäß CEI EN 61340-5-1: 2016, für denjenigen, der sie trägt / Schuhe / Boden, ist zwischen < 1 × 10⁹ Ω.

KLASSIFIZIERUNG DER SCHUHE

Klasse I: Schuhe aus Leder oder anderen Materialien ausgenommen ganz aus Gummi sowie ganz aus Polymeren bestehende Schuhe.

Klasse II: Ganz aus Gummi bestehende (das heißt vollständig vulkanisierte) Schuhe und ganz aus Polymeren bestehende (das heißt vollständig spritzgegossene) Schuhe).

GRUNDANFORDERUNGEN

- **Ganzer Schuh:** Höhe des Oberteils; Fersenbereich; Leistungen des Sohlenaufbaus (Aufbau und Beständigkeit gegen die Ablösung der Sohle vom Oberteil); Zehenschutz und Merkmale der Zehenschutzkappe (außer EN ISO 20347); Rutschhemmung.
- **Oberteil:** Merkmale der Oberteilmaterialien, Futter, Lasche, Innensohle (Reiß- und Abriebfestigkeit, Traktionsmerkmale, Wasserdampfdurchlässigkeit, pH-Wert, Wasseraufnahme und -abgabe von Innensohle und Einlegesohle).
- **Sohle:** Konstruktion und Reiß- sowie Abriebfestigkeit, Biegefestigkeit, Beständigkeit gegen Hydrolyse, die Ablösung von Sohlenschichten und gegen Öle und Kohlenwasserstoffe.

SCHUTZKLASSE	EN ISO 20345:2022											EN ISO 20347:2022						ERFORDERLICHE MINDESTWERTE
	SB	S1	S2	S3	S3L	S3S	S6	S7	S7L	S7S	OB	O1	O2	O3	O3L	O3S		
Klasse	I o II	I	I	I	I	I	I	I	I	I	I o II	I	I	I	I	I		
Geschlossener Fersenbereich	0	X	X	X	X	X	X	X	X	X	0	X	X	X	X	X		
Stoßfestigkeit der Zehenschutzkappe 200 Joule	X	X	X	X	X	X	X	X	X	X	-	-	-	-	-	-		
Profilierte Laufsohle	0	0	0	X	X	X	0	X	X	X	0	0	0	X	X	X		
P Durchtrittfestigkeit (Metalleinsatz P) *	0	0	0	X	-	-	0	X	-	-	0	0	0	X	-	-		
PL Durchtrittfestigkeit (nichtmetallischer Einsatz, Nachweis mit Nagel Ø 4,5 mm) *	0	0	0	-	X	-	0	-	X	-	0	0	0	-	X	-		
PS Durchtrittfestigkeit (nichtmetallischer Einsatz, Nachweis mit Nagel Ø 3,0 mm) *	0	0	0	-	-	X	0	-	-	X	0	0	0	-	-	X		
A Antistatische Schuhe	0	X	X	X	X	X	X	X	X	X	0	X	X	X	X	X		
HI Wärmeisolierung des Sohlenkomplexes	0	0	0	0	0	0	0	0	0	0	0	0	0	0	0	0		
CI Kälteisolierung des Sohlenkomplexes	0	0	0	0	0	0	0	0	0	0	0	0	0	0	0	0		
E Energieaufnahmevermögen im Fersenbereich	0	X	X	X	X	X	X	X	X	X	0	X	X	X	X	X		
WR Wasserdichtigkeit	0	0	0	0	0	0	X	X	X	X	0	0	0	0	0	0		
SC Abriebfestigkeit der Zehenkappenabdeckung	0	0	0	0	0	0	0	0	0	0	0	0	0	0	0	0		
SR Rutschfestigkeit auf Keramikboden mit Glycerin	X	X	X	X	X	X	X	X	X	X	X	X	X	X	X	X		
WPA Wasserdurchdringung und -aufnahme	0	0	X	X	X	X	-	-	-	-	0	0	X	X	X	X		
HRO Kontaktwärmebeständigkeit	0	0	0	0	0	0	0	0	0	0	0	0	0	0	0	0		
FO Beständigkeit gegen Kohlenwasserstoffe	0	0	0	0	0	0	0	0	0	0	0	0	0	0	0	0		
LG Grip auf Leiter	0	0	0	0	0	0	0	0	0	0	0	0	0	0	0	0		

X	Obligatorische Anforderung der Schutzkategorie
O	Fakultative Anforderung zusätzlich zu den Pflichtanforderungen, sofern in der Kennzeichnung angegeben
-	Nicht obligatorische Anforderung, Schuhkennzeichnung kontrollieren

Leitfähige Schuhe

Leitfähige Schuhe sind vorgeschrieben, wenn elektrostatische Aufladungen binnen kürzester Zeit minimiert werden müssen, wie beispielsweise bei der Handhabung von Sprengstoffen.

Sie dürfen nicht verwendet werden, wenn die von strombetriebenen Geräten oder unter Wechsel- bzw. Gleichspannung stehenden Teilen ausgehende Stromschlaggefahr nicht vollständig ausgeschlossen wurde. Zur Gewährleistung der Leitfähigkeit dieser Schuhe wurde als Obergrenze des Durchgangswiderstands im Neuzustand 100 kΩ festgelegt.

Antistatische Schuhe



Die antistatischen Schuhe werden benutzt, wenn die Notwendigkeit besteht, die Ansammlung von elektrostatischen Aufladungen auf ein Minimum zu reduzieren, um die Verbrennungsgefahr von entflammaren Stoffen und Dämpfen auszuschließen, und wenn die Gefahr von Stromschlag durch unter Spannung stehende Elemente besteht. Die antistatischen Schuhe liefern keinen Schutz gegen Stromschlag, da sie nur einen elektrischen Widerstand zwischen dem Boden und dem Fuß herstellen. Falls die Gefahr von Stromschlag nicht gänzlich ausgeschlossen werden kann, müssen zusätzliche Maßnahmen getroffen werden, die Teil eines Arbeitsunfallverhütungsprogramm sein sollten. Zur Wahrung der antistatischen Anforderungen dürfen keine Änderungen an den Schuhen vorgenommen werden.

Nach der alten Richtlinie ausgestellte Zertifizierungen unserer Schuhe bleiben bis zu ihrem Ablaufdatum gültig

EN ISO 20345:2011		S1P SRC										
LINIE	ARTIKEL	ANFORDERUNGEN				EMPFOHLENE SEKTOREN						📄
		ZUSÄTZLICHE ANFORDERUNGEN				AUTOMOTIVE	BAUWESEN	ELEKTRIZITÄT	INDUSTRIE	SERVICE LOGISTIK	THERMOHYDRAULIK	
FLEX 	7212G	ESD		X	X	X	X	X	X	X	635	
	7212B	ESD		X	X	X	X	X	X	X	634	
	7213G	ESD		X	X	X	X	X	X	X	635	
EASY PLUS 	7222PEK			X	X	X	X	X	X	X	633	
	7223PEK			X	X	X	X	X	X	X	633	
BASIC 	7241BK				X	X	X	X	X	X	630	
	7243BK				X	X	X	X	X	X	630	
	7246BK				X	X	X	X	X	X	632	
	7247BK				X	X	X	X	X	X	632	
EASY 	7246E				X	X	X	X	X	X	629	
TREKKING 	7249GK	RS			X	X	X	X	X	X	638	
ACTIVE 	7314AF			X	X	X	X	X	X	X	639	
	7316NB	ESD		X	X	X	X	X	X	X	639	
	7316NG	ESD		X	X	X	X	X	X	X	640	
	7317NA			X	X	X	X	X	X	X	640	
0-GRAVITY 	7352A	HRO		X	X	X	X	X	X	X	642	
	7352B	HRO		X	X	X	X	X	X	X	642	
	7352G	HRO ESD	X	X	X	X	X	X	X	X	642	
	7353Y	HRO		X	X	X	X	X	X	X	643	
	7372B	HRO	X	X	X	X	X	X	X	X	646	
	7376A	HRO	X	X	X	X	X	X	X	X	646	
0-GRAVITY LADY 	7352LG	HRO		X	X	X	X	X	X	X	643	

EN ISO 20347:2012		O1 SRC									
0-GRAVITY 	7362B	FO HRO		X	X	X	X	X	X	X	645

EN ISO 20345:2022		S1PS SR									
0-GRAVITY 	7371V	HRO FO ESD	X	X	X	X	X	X	X	X	645

EN ISO 20347:2012		O2 SRC									
BASIC 	7243FT	FO			X	X	X	X	X	X	631
0-GRAVITY 	7363N	FO HRO		X	X	X	X	X	X	X	645

EN ISO 20345:2011		S3 SRC										
LINIE	ARTIKEL	ANFORDERUNGEN				EMPFOHLENE SEKTOREN						📄
		ZUSÄTZLICHE ANFORDERUNGEN				LANDWIRTSCHAFT	AUTOMOTIVE	BAUWESEN	INDUSTRIE	ELEKTRIZITÄT	SERVICE LOGISTIK	
FLEX 	7214FN			X	X	X	X	X	X	X	635	
	7214G	ESD		X	X	X	X	X	X	X	636	
	7215FN			X	X	X	X	X	X	X	636	
	7218FN	RS		X	X	X	X	X	X	X	636	
	7218G	RS ESD		X	X	X	X	X	X	X	636	
EASY PLUS 	7220PEK			X	X	X	X	X	X	X	633	
	7221PEK	RS		X	X	X	X	X	X	X	633	
TREKKING 	7236BK	RS			X	X	X	X	X	X	638	
	7238WR	RS HRO WR			X	X	X	X	X	X	638	
EASY 	7241EN				X	X	X	X	X	X	629	
	7243EN	RS			X	X	X	X	X	X	629	
BASIC 	7241CK				X	X	X	X	X	X	630	
	7243CK	RS			X	X	X	X	X	X	631	
	7243CR	RS HRO			X	X	X	X	X	X	631	
HEAVY DUTY 	7245BK	RS			X	X	X	X	X	X	631	
	7293HM	HRO HI	X		X	X	X	X	X	X	647	
	7294HM	HRO HI	X		X	X	X	X	X	X	647	
ACTIVE 	7294HMC	HRO HI CI WR	X		X	X	X	X	X	X	647	
	7315AN			X	X	X	X	X	X	X	639	
	7318AN			X	X	X	X	X	X	X	640	
0-GRAVITY 	7320NA			X	X	X	X	X	X	X	640	
	7321NA	RS		X	X	X	X	X	X	X	641	
	7322SA			X	X	X	X	X	X	X	641	
	7323SA	RS		X	X	X	X	X	X	X	641	
	7354N	HRO		X	X	X	X	X	X	X	643	
	7355V	HRO		X	X	X	X	X	X	X	643	
0-GRAVITY LADY 	7356G	HRO		X	X	X	X	X	X	X	644	
	7357G	HRO		X	X	X	X	X	X	X	644	
	7356V	HRO		X	X	X	X	X	X	X	644	
0-GRAVITY 	7357V	HRO		X	X	X	X	X	X	X	645	
	7356LN	HRO		X	X	X	X	X	X	X	644	
	7381N	HRO WR	X	X	X	X	X	X	X	X	646	
0-GRAVITY 	7382N	HRO WR	X	X	X	X	X	X	X	X	646	

EN ISO 20345:2011		S5 SRC									
BASIC 	7328A				X	X	X	X	X	X	632
	7328N				X	X	X	X	X	X	632

EASY



7241EN

Lederschuhe, wasserabweisend

- Zehenschutzkappe aus Stahl
- Durchtrittssichere Einlage aus Federstahl

**EN ISO
20345
2011**



EU	UK	mm	€	W	S
35	2,5	230	44,50	1	072410835
36	3,5	237	44,50	1	072410836
37	4,5	244	44,50	1	072410837
38	5	250	44,50	1	072410838
39	6	257	44,50	1	072410839
40	6,5	264	44,50	1	072410840
41	7	270	44,50	1	072410841
42	8	277	44,50	1	072410842
43	9	284	44,50	1	072410843
44	10	290	44,50	1	072410844
45	10,5	297	44,50	1	072410845
46	11	304	44,50	1	072410846
47	12	310	44,50	1	072410847
48	13	317	44,50	1	072410848



CE

S3 SRC

7243EN

Schnür-Lederstiefel, wasserabweisend,
rasch abstreifbar

- Zehenschutzkappe aus Stahl
- Durchtrittssichere Einlage aus Federstahl

**EN ISO
20345
2011**



EU	UK	mm	€	W	S
35	2,5	230	46,00	1	072430835
36	3,5	237	46,00	1	072430836
37	4,5	244	46,00	1	072430837
38	5	250	46,00	1	072430838
39	6	257	46,00	1	072430839
40	6,5	264	46,00	1	072430840
41	7	270	46,00	1	072430841
42	8	277	46,00	1	072430842
43	9	284	46,00	1	072430843
44	10	290	46,00	1	072430844
45	10,5	297	46,00	1	072430845
46	11	304	46,00	1	072430846
47	12	310	46,00	1	072430847
48	13	317	46,00	1	072430848



CE

S3 RS SRC

7246E

Wildlederschuhe, perforiert

- Zehenschutzkappe aus Stahl
- Durchtrittssichere Einlage aus Federstahl

**EN ISO
20345
2011**



EU	UK	mm	€	W	S
35	2,5	230	46,00	1	072460435
36	3,5	237	46,00	1	072460436
37	4,5	244	46,00	1	072460437
38	5	250	46,00	1	072460438
39	6	257	46,00	1	072460439
40	6,5	264	46,00	1	072460440
41	7	270	46,00	1	072460441
42	8	277	46,00	1	072460442
43	9	284	46,00	1	072460443
44	10	290	46,00	1	072460444
45	10,5	297	46,00	1	072460445
46	11	304	46,00	1	072460446
47	12	310	46,00	1	072460447
48	13	317	46,00	1	072460448



CE

S1P SRC

BASIC



7241BK Lederschuhe

- Zehenschutzkappe aus Stahl
- Durchtrittsichere Einlage aus Verbundfaser

EU	UK	mm	€	CE	Art-Nr.
35	2,5	228	54,00	1	072411235
36	3,5	235	54,00	1	072411236
37	4,5	242	54,00	1	072411237
38	5	248	54,00	1	072411238
39	6	255	54,00	1	072411239
40	6,5	262	54,00	1	072411240
41	7	268	54,00	1	072411241
42	8	275	54,00	1	072411242
43	9	282	54,00	1	072411243
44	10	288	54,00	1	072411244
45	10,5	295	54,00	1	072411245
46	11	302	54,00	1	072411246
47	12	308	54,00	1	072411247
48	13	315	54,00	1	072411248



CE

S1P SRC

**EN ISO
20345
2011**



7241CK Lederschuhe, wasserabweisend

- Zehenschutzkappe aus Stahl
- Durchtrittsichere Einlage aus Federstahl

EU	UK	mm	€	CE	Art-Nr.
35	2,5	228	55,00	1	072411535
36	3,5	235	55,00	1	072411536
37	4,5	242	55,00	1	072411537
38	5	248	55,00	1	072411538
39	6	255	55,00	1	072411539
40	6,5	262	55,00	1	072411540
41	7	268	55,00	1	072411541
42	8	275	55,00	1	072411542
43	9	282	55,00	1	072411543
44	10	288	55,00	1	072411544
45	10,5	295	55,00	1	072411545
46	11	302	55,00	1	072411546
47	12	308	55,00	1	072411547
48	13	315	55,00	1	072411548



CE

S3 SRC

**EN ISO
20345
2011**



7243BK Schnür-Lederstiefel

- Zehenschutzkappe aus Stahl
- Durchtrittsichere Einlage aus Verbundfaser

EU	UK	mm	€	CE	Art-Nr.
35	2,5	228	55,00	1	072431235
36	3,5	235	55,00	1	072431236
37	4,5	242	55,00	1	072431237
38	5	248	55,00	1	072431238
39	6	255	55,00	1	072431239
40	6,5	262	55,00	1	072431240
41	7	268	55,00	1	072431241
42	8	275	55,00	1	072431242
43	9	282	55,00	1	072431243
44	10	288	55,00	1	072431244
45	10,5	295	55,00	1	072431245
46	11	302	55,00	1	072431246
47	12	308	55,00	1	072431247
48	13	315	55,00	1	072431248



CE

S1P SRC

**EN ISO
20345
2011**



7243CK

Schnür-Lederstiefel, wasserabweisend, rasch abstreifbar

- Zehenschutzkappe aus Stahl
- Durchtrittssichere Einlage aus Verbundfaser

EU	UK	mm	€	W	W
35	2,5	228	56,50	1	072431335
36	3,5	235	56,50	1	072431336
37	4,5	242	56,50	1	072431337
38	5	248	56,50	1	072431338
39	6	255	56,50	1	072431339
40	6,5	262	56,50	1	072431340
41	7	268	56,50	1	072431341
42	8	275	56,50	1	072431342
43	9	282	56,50	1	072431343
44	10	288	56,50	1	072431344
45	10,5	295	56,50	1	072431345
46	11	302	56,50	1	072431346
47	12	308	56,50	1	072431347
48	13	315	56,50	1	072431348

CE



S3 RS SRC

EN ISO 20345 2011



7243CR

Schnür-Stiefel aus Leder, wasserabweisend, hochwiderstandsfähige Gummilaufsohle, rasch abstreifbar

- Zehenschutzkappe aus Stahl
- Durchtrittssichere Einlage aus elastischem Stahl

EU	UK	mm	€	W	W
35	2,5	231	83,50	1	072430735
36	3,5	238	83,50	1	072430736
37	4,5	245	83,50	1	072430737
38	5	251	83,50	1	072430738
39	6	258	83,50	1	072430739
40	6,5	265	83,50	1	072430740
41	7	271	83,50	1	072430741
42	8	278	83,50	1	072430742
43	9	285	83,50	1	072430743
44	10	291	83,50	1	072430744
45	10,5	298	83,50	1	072430745
46	11	305	83,50	1	072430746
47	12	311	83,50	1	072430747
48	13	318	83,50	1	072430748

CE



S3 RS HRO SRC

EN ISO 20345 2011



7243FT

Schnür-Lederstiefel, wasserdicht, ohne Zehenschutzkappe und ohne durchtrittssichere Einlage

- Ohne Zehenschutzkappe
- Ohne durchtrittssichere Einlage

EU	UK	mm	€	W	W
35	2,5	228	49,00	1	072430635
36	3,5	235	49,00	1	072430636
37	4,5	242	49,00	1	072430637
38	5	248	49,00	1	072430638
39	6	255	49,00	1	072430639
40	6,5	262	49,00	1	072430640
41	7	268	49,00	1	072430641
42	8	275	49,00	1	072430642
43	9	282	49,00	1	072430643
44	10	288	49,00	1	072430644
45	10,5	295	49,00	1	072430645
46	11	302	49,00	1	072430646
47	12	308	49,00	1	072430647
48	13	315	49,00	1	072430648

CE



O2 FO SRC

EN ISO 20347 2012



7245BK

"Schweißertiefel", geschnürt, aus Leder, wasserabweisend, rasch abstreifbar, mit vorderem Schutz und Klettverschluss

- Zehenschutzkappe aus Stahl
- Durchtrittssichere Einlage aus Verbundfaser

EU	UK	mm	€	W	W
35	2,5	228	65,00	1	072451235
36	3,5	235	65,00	1	072451236
37	4,5	242	65,00	1	072451237
38	5	248	65,00	1	072451238
39	6	255	65,00	1	072451239
40	6,5	262	65,00	1	072451240
41	7	268	65,00	1	072451241
42	8	275	65,00	1	072451242
43	9	282	65,00	1	072451243
44	10	288	65,00	1	072451244
45	10,5	295	65,00	1	072451245
46	11	302	65,00	1	072451246
47	12	308	65,00	1	072451247
48	13	315	65,00	1	072451248

CE



S3 RS SRC

EN ISO 20345 2011



7246BK

Wildlederschuhe, perforiert

- Zehenschutzkappe aus Stahl
- Durchtrittsichere Einlage aus Verbundfaser

EU	UK	mm	€		
35	2,5	228	56,50	1	072461235
36	3,5	235	56,50	1	072461236
37	4,5	242	56,50	1	072461237
38	5	248	56,50	1	072461238
39	6	255	56,50	1	072461239
40	6,5	262	56,50	1	072461240
41	7	268	56,50	1	072461241
42	8	275	56,50	1	072461242
43	9	282	56,50	1	072461243
44	10	288	56,50	1	072461244
45	10,5	295	56,50	1	072461245
46	11	302	56,50	1	072461246
47	12	308	56,50	1	072461247
48	13	315	56,50	1	072461248

CE



S1P SRC

EN ISO 20345 2011



7247BK

Ledersandalen, perforiert

- Zehenschutzkappe aus Stahl
- Durchtrittsichere Einlage aus Verbundfaser

EU	UK	mm	€		
35	2,5	228	56,00	1	072471235
36	3,5	235	56,00	1	072471236
37	4,5	242	56,00	1	072471237
38	5	248	56,00	1	072471238
39	6	255	56,00	1	072471239
40	6,5	262	56,00	1	072471240
41	7	268	56,00	1	072471241
42	8	275	56,00	1	072471242
43	9	282	56,00	1	072471243
44	10	288	56,00	1	072471244
45	10,5	295	56,00	1	072471245
46	11	302	56,00	1	072471246
47	12	308	56,00	1	072471247
48	13	315	56,00	1	072471248

CE



S1P SRC

EN ISO 20345 2011



7328A

Hoch sichtbare Sicherheitsstiefel aus Nitril-PVC. Selbstreinigende, rutschfeste Laufsohle.

- Zehenschutzkappe aus Stahl
- Durchtrittsichere Einlage aus elastischem Stahl

EU	UK	mm	€		
38	5	253	44,00	1	073280638
39	6	260	44,00	1	073280639
40	6,5	267	44,00	1	073280640
41	7	273	44,00	1	073280641
42	8	280	44,00	1	073280642
43	9	287	44,00	1	073280643
44	10	293	44,00	1	073280644
45	10,5	300	44,00	1	073280645
46	11	307	44,00	1	073280646
47	12	313	44,00	1	073280647

CE



S5 SRC

EN ISO 20345 2011



7328N

Sicherheitsstiefel aus Nitril-PVC. Selbstreinigende, rutschfeste Laufsohle.

- Zehenschutzkappe aus Stahl
- Durchtrittsichere Einlage aus elastischem Stahl

EU	UK	mm	€		
38	5	253	44,00	1	073280838
39	6	260	44,00	1	073280839
40	6,5	267	44,00	1	073280840
41	7	273	44,00	1	073280841
42	8	280	44,00	1	073280842
43	9	287	44,00	1	073280843
44	10	293	44,00	1	073280844
45	10,5	300	44,00	1	073280845
46	11	307	44,00	1	073280846
47	12	313	44,00	1	073280847

CE



S5 SRC

EN ISO 20345 2011



EASY PLUS



7220PEK

Lederschuhe, wasserabweisend, mit Nyloneinsätzen und abriebfester Verstärkung auf der Zehenschutzkappe

- Zehenschutzkappe aus Verbundmaterial
- Durchtrittsichere Einlage aus Verbundfaser

**EN ISO
20345
2011**

METAL
FREE



EU	UK	mm	€	U	PC
35	2,5	228	74,50	1	072200235
36	3,5	235	74,50	1	072200236
37	4,5	242	74,50	1	072200237
38	5	248	74,50	1	072200238
39	6	255	74,50	1	072200239
40	6,5	262	74,50	1	072200240
41	7	268	74,50	1	072200241
42	8	275	74,50	1	072200242
43	9	282	74,50	1	072200243
44	10	288	74,50	1	072200244
45	10,5	295	74,50	1	072200245
46	11	302	74,50	1	072200246
47	12	308	74,50	1	072200247
48	13	315	74,50	1	072200248

CE



S3 SRC

7221PEK

Schnür-Lederstiefel, wasserabweisend, mit Nyloneinsätzen und abriebfester Verstärkung auf der Zehenschutzkappe, rasch abstreifbar

- Zehenschutzkappe aus Verbundmaterial
- Durchtrittsichere Einlage aus Verbundfaser

**EN ISO
20345
2011**

METAL
FREE



EU	UK	mm	€	U	PC
35	2,5	228	77,50	1	072210235
36	3,5	235	77,50	1	072210236
37	4,5	242	77,50	1	072210237
38	5	248	77,50	1	072210238
39	6	255	77,50	1	072210239
40	6,5	262	77,50	1	072210240
41	7	268	77,50	1	072210241
42	8	275	77,50	1	072210242
43	9	282	77,50	1	072210243
44	10	288	77,50	1	072210244
45	10,5	295	77,50	1	072210245
46	11	302	77,50	1	072210246
47	12	308	77,50	1	072210247
48	13	315	77,50	1	072210248

CE



S3 RS SRC

7222PEK

Schuhe aus perforiertem Wildleder mit Mesh-Einsätzen, hoch atmungsaktiv

- Zehenschutzkappe aus Verbundmaterial
- Durchtrittsichere Einlage aus Verbundfaser

**EN ISO
20345
2011**

METAL
FREE



EU	UK	mm	€	U	PC
35	2,5	228	71,50	1	072220135
36	3,5	235	71,50	1	072220136
37	4,5	242	71,50	1	072220137
38	5	248	71,50	1	072220138
39	6	255	71,50	1	072220139
40	6,5	262	71,50	1	072220140
41	7	268	71,50	1	072220141
42	8	275	71,50	1	072220142
43	9	282	71,50	1	072220143
44	10	288	71,50	1	072220144
45	10,5	295	71,50	1	072220145
46	11	302	71,50	1	072220146
47	12	308	71,50	1	072220147
48	13	315	71,50	1	072220148

CE



S1P SRC

7223PEK

Wildlederschuhe mit atmungsaktiven Mesh-Einsätzen und abriebfester Verstärkung auf der Zehenschutzkappe

- Zehenschutzkappe aus Verbundmaterial
- Durchtrittsichere Einlage aus Verbundfaser

**EN ISO
20345
2011**

METAL
FREE



EU	UK	mm	€		
35	2,5	228	77,00	1	072230135
36	3,5	235	77,00	1	072230136
37	4,5	242	77,00	1	072230137
38	5	248	77,00	1	072230138
39	6	255	77,00	1	072230139
40	6,5	262	77,00	1	072230140
41	7	268	77,00	1	072230141
42	8	275	77,00	1	072230142
43	9	282	77,00	1	072230143
44	10	288	77,00	1	072230144
45	10,5	295	77,00	1	072230145
46	11	302	77,00	1	072230146
47	12	308	77,00	1	072230147
48	13	315	77,00	1	072230148



CE

S1P SRC

FLEX



7212B

Schuhe aus perforiertem Wildleder mit Mesh-Einsätzen. Mit abriebfestem Einsatz im Zehenschutzkappenbereich. Höchste Leichtigkeit - Ungefährliches Gewicht. Größe 42: 490 g. Nicht geeignet für schwere Arbeiten (Bauwesen, Landwirtschaft, Schwerindustrie).

- Zehenschutzkappe aus Compound-Material
- Durchtrittsichere Einlage aus Compound-Faser

**EN ISO
20345
2011**

ESD

METAL
FREE



EU	UK	mm	€		
35	2,5	228	82,50	1	072120235
36	3,5	235	82,50	1	072120236
37	4,5	242	82,50	1	072120237
38	5	248	82,50	1	072120238
39	6	255	82,50	1	072120239
40	6,5	262	82,50	1	072120240
41	7	268	82,50	1	072120241
42	8	275	82,50	1	072120242
43	9	282	82,50	1	072120243
44	10	288	82,50	1	072120244
45	10,5	295	82,50	1	072120245
46	11	302	82,50	1	072120246
47	12	308	82,50	1	072120247
48	13	315	82,50	1	072120248



CE

S1P SRC ESD

 **Beta**

7212G

Schuhe aus perforiertem Wildleder. Mit abriebfestem Einsatz im Zehenschutzkappenbereich Extrem flexibel und leicht - Ungefähres Gewicht Größe 42: 490 g Nicht geeignet für schwere Arbeiten (Bauwesen, Landwirtschaft, Schwerindustrie)

- Zehenschutzkappe aus Compound-Material
- Durchtrittsichere Einlage aus Compound-Faser

EU	UK	mm	€	Hand	Foot
35	2.5	228	82,50	1	072120335
36	3.5	235	82,50	1	072120336
37	4.5	242	82,50	1	072120337
38	5	248	82,50	1	072120338
39	6	255	82,50	1	072120339
40	6.5	262	82,50	1	072120340
41	7	268	82,50	1	072120341
42	8	275	82,50	1	072120342
43	9	282	82,50	1	072120343
44	10	288	82,50	1	072120344
45	10.5	295	82,50	1	072120345
46	11	302	82,50	1	072120346
47	12	308	82,50	1	072120347
48	13	315	82,50	1	072120348

CE



S1P SRC ESD



EN ISO 20345 2011



7213G

Schuhe aus perforiertem Wildleder mit hoch atmungsaktiven Mesh-Einsätzen Extrem flexibel und leicht - Ungefähres Gewicht Größe 42: 490 g Nicht geeignet für schwere Arbeiten (Bauwesen, Landwirtschaft, Schwerindustrie)

- Zehenschutzkappe aus Compound-Material
- Durchtrittsichere Einlage aus Compound-Faser

EU	UK	mm	€	Hand	Foot
35	2.5	228	82,50	1	072130135
36	3.5	235	82,50	1	072130136
37	4.5	242	82,50	1	072130137
38	5	248	82,50	1	072130138
39	6	255	82,50	1	072130139
40	6.5	262	82,50	1	072130140
41	7	268	82,50	1	072130141
42	8	275	82,50	1	072130142
43	9	282	82,50	1	072130143
44	10	288	82,50	1	072130144
45	10.5	295	82,50	1	072130145
46	11	302	82,50	1	072130146
47	12	308	82,50	1	072130147
48	13	315	82,50	1	072130148

CE



S1P SRC ESD



EN ISO 20345 2011



7214FN

Schuhe aus "Action"-Nubukleder, wasserabweisend, mit abriebfestem Einsatz im Zehenschutzkappenbereich Extrem flexibel und leicht - Ungefähres Gewicht Größe 42: 500 g Nicht geeignet für schwere Arbeiten (Bauwesen, Landwirtschaft, Schwerindustrie)

- Zehenschutzkappe aus Compound-Material
- Durchtrittsichere Einlage aus Compound-Faser

EU	UK	mm	€	Hand	Foot
35	2,5	228	89,50	1	072140035
36	3,5	235	89,50	1	072140036
37	4,5	242	89,50	1	072140037
38	5	248	89,50	1	072140038
39	6	255	89,50	1	072140039
40	6,5	262	89,50	1	072140040
41	7	268	89,50	1	072140041
42	8	275	89,50	1	072140042
43	9	282	89,50	1	072140043
44	10	288	89,50	1	072140044
45	10,5	295	89,50	1	072140045
46	11	302	89,50	1	072140046
47	12	308	89,50	1	072140047
48	13	315	89,50	1	072140048

CE



S3 SRC



EN ISO 20345 2011



Beta

7214G

Schuhe aus "Action"-Nubukleder, wasserabweisend, mit abriebfestem Einsatz im Zehenschutzkappenbereich Extrem flexibel und leicht - Ungefährtes Gewicht Größe 42: 500 g Nicht geeignet für schwere Arbeiten (Bauwesen, Landwirtschaft, Schwerindustrie)

- Zehenschutzkappe aus Compound-Material
- Durchtrittsichere Einlage aus Compound-Faser

EU	UK	mm	€		
35	2.5	228	89,50	1	072140235
36	3.5	235	89,50	1	072140236
37	4.5	242	89,50	1	072140237
38	5	248	89,50	1	072140238
39	6	255	89,50	1	072140239
40	6.5	262	89,50	1	072140240
41	7	268	89,50	1	072140241
42	8	275	89,50	1	072140242
43	9	282	89,50	1	072140243
44	10	288	89,50	1	072140244
45	10.5	295	89,50	1	072140245
46	11	302	89,50	1	072140246
47	12	308	89,50	1	072140247
48	13	315	89,50	1	072140248

CE



S3 SRC ESD



EN ISO 20345 2011



7215FN

Mokassins aus "Action"-Nubukleder, wasserabweisend, mit abriebfestem Einsatz im Zehenschutzkappenbereich Extrem flexibel und leicht - Ungefährtes Gewicht Größe 42: 490 g Nicht geeignet für schwere Arbeiten (Bauwesen, Landwirtschaft, Schwerindustrie)

- Zehenschutzkappe aus Compound-Material
- Durchtrittsichere Einlage aus Compound-Faser

EU	UK	mm	€		
35	2.5	228	90,50	1	072150135
36	3.5	235	90,50	1	072150136
37	4.5	242	90,50	1	072150137
38	5	248	90,50	1	072150138
39	6	255	90,50	1	072150139
40	6.5	262	90,50	1	072150140
41	7	268	90,50	1	072150141
42	8	275	90,50	1	072150142
43	9	282	90,50	1	072150143
44	10	288	90,50	1	072150144
45	10.5	295	90,50	1	072150145
46	11	302	90,50	1	072150146
47	12	308	90,50	1	072150147
48	13	315	90,50	1	072150148

CE



S3 SRC



EN ISO 20345 2011



7218FN

Schnür-Stiefel aus "Action"-Nubukleder, wasserabweisend, mit abriebfestem Einsatz im Zehenschutzkappenbereich, rasch abstreifbar Extrem flexibel und leicht - Ungefährtes Gewicht Größe 42: 510 g Nicht geeignet für schwere Arbeiten (Bauwesen, Landwirtschaft, Schwerindustrie)

- Zehenschutzkappe aus Verbundmaterial
- Durchtrittsichere Einlage aus Verbundfaser

EU	UK	mm	€		
35	2.5	228	93,50	1	072180035
36	3.5	235	93,50	1	072180036
37	4.5	242	93,50	1	072180037
38	5	248	93,50	1	072180038
39	6	255	93,50	1	072180039
40	6.5	262	93,50	1	072180040
41	7	268	93,50	1	072180041
42	8	275	93,50	1	072180042
43	9	282	93,50	1	072180043
44	10	288	93,50	1	072180044
45	10.5	295	93,50	1	072180045
46	11	302	93,50	1	072180046
47	12	308	93,50	1	072180047
48	13	315	93,50	1	072180048

CE



S3 RS SRC



EN ISO 20345 2011



7218G

Schnür-Stiefel aus "Action"-Nubukleder, wasserabweisend, mit abriebfestem Einsatz im Zehenschutzkappenbereich. Rasch abstreifbar Extrem flexibel und leicht - Ungefährtes Gewicht Größe 42: 550 g Nicht geeignet für schwere Arbeiten (Bauwesen, Landwirtschaft, Schwerindustrie)

- Zehenschutzkappe aus Compound-Material
- Durchtrittsichere Einlage aus Compound-Faser

EU	UK	mm	€		
35	2.5	228	93,50	1	072180135
36	3.5	235	93,50	1	072180136
37	4.5	242	93,50	1	072180137
38	5	248	93,50	1	072180138
39	6	255	93,50	1	072180139
40	6.5	262	93,50	1	072180140
41	7	268	93,50	1	072180141
42	8	275	93,50	1	072180142
43	9	282	93,50	1	072180143
44	10	288	93,50	1	072180144
45	10.5	295	93,50	1	072180145
46	11	302	93,50	1	072180146
47	12	308	93,50	1	072180147
48	13	315	93,50	1	072180148

CE



S3 RS SRC ESD



EN ISO 20345 2011



BASIC PLUS



7201BKK

Schnür-Stiefel aus vollnarbigem Leder, wasserabweisend
NICHT ZUM VERKAUF VERFÜGBAR

- Zehenschutzkappe aus Verbundmaterial
- Durchtrittssichere Einlage aus Verbundfaser

EU	UK	mm	
35	2,5	228	1 072010435
36	3,5	235	1 072010436
37	4,5	242	1 072010437
38	5	248	1 072010438
39	6	255	1 072010439
40	6,5	262	1 072010440
41	7	268	1 072010441
42	8	275	1 072010442
43	9	282	1 072010443
44	10	288	1 072010444
45	10,5	295	1 072010445
46	11	302	1 072010446
47	12	308	1 072010447
48	13	315	1 072010448



CE

S3 SRC

**EN ISO
20345
2011**



7210BKK

Schuhe aus weichem Wildleder, perforiert
NICHT ZUM VERKAUF VERFÜGBAR

- Zehenschutzkappe aus Verbundmaterial
- Durchtrittssichere Einlage aus Verbundfaser

EU	UK	mm	
35	2,5	228	1 072100335
36	3,5	235	1 072100336
37	4,5	242	1 072100337
38	5	248	1 072100338
39	6	255	1 072100339
40	6,5	262	1 072100340
41	7	268	1 072100341
42	8	275	1 072100342
43	9	282	1 072100343
44	10	288	1 072100344
45	10,5	295	1 072100345
46	11	302	1 072100346
47	12	308	1 072100347
48	13	315	1 072100348



CE

S1P SRC

**EN ISO
20345
2011**



7216BKK

Sandalen aus weichem Wildleder
 mit Klettverschluss
NICHT ZUM VERKAUF VERFÜGBAR

- Zehenschutzkappe aus Verbundmaterial
- Durchtrittssichere Einlage aus Verbundfaser

EU	UK	mm	
35	2,5	228	1 072160335
36	3,5	235	1 072160336
37	4,5	242	1 072160337
38	5	248	1 072160338
39	6	255	1 072160339
40	6,5	262	1 072160340
41	7	268	1 072160341
42	8	275	1 072160342
43	9	282	1 072160343
44	10	288	1 072160344
45	10,5	295	1 072160345
46	11	302	1 072160346
47	12	308	1 072160347
48	13	315	1 072160348



CE

S1P SRC

**EN ISO
20345
2011**



TREKKING



7236BK

Schnür-Stiefel aus "Action"-Nubukleder, wasserabweisend, rasch abstreifbar, mit verstärkter Überkappe aus Polyurethan

- Zehenschutzkappe aus Stahl
- Durchtrittssichere Einlage aus Verbundfaser

EU	UK	mm	€	Stk	Art-Nr.
35	2,5	228	85,00	1	072360335
36	3,5	235	85,00	1	072360336
37	4,5	242	85,00	1	072360337
38	5	248	85,00	1	072360338
39	6	255	85,00	1	072360339
40	6,5	262	85,00	1	072360340
41	7	268	85,00	1	072360341
42	8	275	85,00	1	072360342
43	9	282	85,00	1	072360343
44	10	288	85,00	1	072360344
45	10,5	295	85,00	1	072360345
46	11	302	85,00	1	072360346
47	12	308	85,00	1	072360347
48	13	315	85,00	1	072360348

CE



S3 RS SRC

EN ISO 20345 2011



7238WR

Schnür-Stiefel aus Wildleder, mit Nyloneinsätzen, hochwiderstandsfähige Gummilaufsohle, rasch abstreifbar WR-Sicherheitsschuh, wasserbeständig: Geprüft in einer Wanne mit etwa 3 cm Wasser, nach 1000 Längen darf die im Schuh vorhandene nasse Fläche nicht 3 cm² (Flecken) überschreiten

- Zehenschutzkappe aus Compound-Material
- Durchtrittssichere Einlage aus Compound-Faser

EU	UK	mm	€	Stk	Art-Nr.
35	2,5	228	114,00	1	072380235
36	3,5	235	114,00	1	072380236
37	4,5	242	114,00	1	072380237
38	5	248	114,00	1	072380238
39	6	255	114,00	1	072380239
40	6,5	262	114,00	1	072380240
41	7	268	114,00	1	072380241
42	8	275	114,00	1	072380242
43	9	282	114,00	1	072380243
44	10	288	114,00	1	072380244
45	10,5	295	114,00	1	072380245
46	11	302	114,00	1	072380246
47	12	308	114,00	1	072380247
48	13	315	114,00	1	072380248

CE



S3 RS WR HRO SRC

EN ISO 20345 2011



7249GK

Schnür-Stiefel aus Wildleder mit Nylon-Einsätzen, rasch abstreifbar, mit verstärkter Überkappe aus Polyurethan

- Zehenschutzkappe aus Stahl
- Durchtrittssichere Einlage aus Verbundfaser

EU	UK	mm	€	Stk	Art-Nr.
35	2,5	231	71,50	1	072490235
36	3,5	238	71,50	1	072490236
37	4,5	245	71,50	1	072490237
38	5	251	71,50	1	072490238
39	6	258	71,50	1	072490239
40	6,5	265	71,50	1	072490240
41	7	271	71,50	1	072490241
42	8	278	71,50	1	072490242
43	9	285	71,50	1	072490243
44	10	291	71,50	1	072490244
45	10,5	298	71,50	1	072490245
46	11	305	71,50	1	072490246
47	12	311	71,50	1	072490247
48	13	318	71,50	1	072490248

CE



S1P RS SRC

EN ISO 20345 2011



ACTIVE



7314AF

Wildlederschuhe
mit Nylongewebe- und Carbon-Einsätzen

- Zehenschutzklappe aus Compound-Material
- Durchtrittsichere Einlage aus Compound-Faser

**EN ISO
20345
2011**

EU	UK	mm	€	W	W
35	2,5	228	113,50	1	073140235
36	3,5	235	113,50	1	073140236
37	4,5	242	113,50	1	073140237
38	5	248	113,50	1	073140238
39	6	255	113,50	1	073140239
40	6,5	262	113,50	1	073140240
41	7	268	113,50	1	073140241
42	8	275	113,50	1	073140242
43	9	282	113,50	1	073140243
44	10	288	113,50	1	073140244
45	10,5	295	113,50	1	073140245
46	11	302	113,50	1	073140246
47	12	308	113,50	1	073140247
48	13	315	113,50	1	073140248



CE

S1P SRC

METAL
FREE



7315AN

Schuhe aus Wildleder und Mikrofaser,
wasserabweisend, mit Carbon-Einsätzen

- Zehenschutzklappe aus Compound-Material
- Durchtrittsichere Einlage aus Compound-Faser

**EN ISO
20345
2011**

EU	UK	mm	€	W	W
35	2,5	228	131,00	1	073150535
36	3,5	235	131,00	1	073150536
37	4,5	242	131,00	1	073150537
38	5	248	131,00	1	073150538
39	6	255	131,00	1	073150539
40	6,5	262	131,00	1	073150540
41	7	268	131,00	1	073150541
42	8	275	131,00	1	073150542
43	9	282	131,00	1	073150543
44	10	288	131,00	1	073150544
45	10,5	295	131,00	1	073150545
46	11	302	131,00	1	073150546
47	12	308	131,00	1	073150547
48	13	315	131,00	1	073150548



CE

S3 SRC

METAL
FREE



7316NB

Schuhe aus hoch atmungsaktivem Mesh-Gewebe und
Wildleder,
mit Fersenstütze

- Zehenschutzklappe aus Compound-Material
- Durchtrittsichere Einlage aus Compound-Faser

**EN ISO
20345
2011**

EU	UK	mm	€	W	W
35	2,5	228	98,50	1	073160735
36	3,5	235	98,50	1	073160736
37	4,5	242	98,50	1	073160737
38	5	248	98,50	1	073160738
39	6	255	98,50	1	073160739
40	6,5	262	98,50	1	073160740
41	7	268	98,50	1	073160741
42	8	275	98,50	1	073160742
43	9	282	98,50	1	073160743
44	10	288	98,50	1	073160744
45	10,5	295	98,50	1	073160745
46	11	302	98,50	1	073160746
47	12	308	98,50	1	073160747
48	13	315	98,50	1	073160748



CE

S1P SRC ESD

ESD

METAL
FREE



7316NG

Schuhe aus hoch atmungsaktivem Mesh-Gewebe und Wildleder, mit Fersenstütze

- Zehenschutzkappe aus Compound-Material
- Durchtrittsichere Einlage aus Compound-Faser

EU	UK	mm	€		
35	2.5	228	98,50	1	073160635
36	3.5	235	98,50	1	073160636
37	4.5	242	98,50	1	073160637
38	5	248	98,50	1	073160638
39	6	255	98,50	1	073160639
40	6.5	262	98,50	1	073160640
41	7	268	98,50	1	073160641
42	8	275	98,50	1	073160642
43	9	282	98,50	1	073160643
44	10	288	98,50	1	073160644
45	10.5	295	98,50	1	073160645
46	11	302	98,50	1	073160646
47	12	308	98,50	1	073160647
48	13	315	98,50	1	073160648

CE



S1P SRC ESD



7317NA

Wildlederschuhe, perforiert mit Mikrofaserverstärkung im Fersenbereich

- Zehenschutzkappe aus Verbundmaterial
- Durchtrittsichere Einlage aus Verbundfaser

EU	UK	mm	€		
35	2.5	228	84,50	1	073170135
36	3.5	235	84,50	1	073170136
37	4.5	242	84,50	1	073170137
38	5	248	84,50	1	073170138
39	6	255	84,50	1	073170139
40	6.5	262	84,50	1	073170140
41	7	268	84,50	1	073170141
42	8	275	84,50	1	073170142
43	9	282	84,50	1	073170143
44	10	288	84,50	1	073170144
45	10.5	295	84,50	1	073170145
46	11	302	84,50	1	073170146
47	12	308	84,50	1	073170147
48	13	315	84,50	1	073170148

CE



S1P SRC



7318AN

Schnür-Stiefel aus Wildleder und Mikrofaser, wasserabweisend, mit Carbon-Einsätzen

- Zehenschutzkappe aus Verbundmaterial
- Durchtrittsichere Einlage aus Verbundfaser

EU	UK	mm	€		
35	2.5	228	135,50	1	073180535
36	3.5	235	135,50	1	073180536
37	4.5	242	135,50	1	073180537
38	5	248	135,50	1	073180538
39	6	255	135,50	1	073180539
40	6.5	262	135,50	1	073180540
41	7	268	135,50	1	073180541
42	8	275	135,50	1	073180542
43	9	282	135,50	1	073180543
44	10	288	135,50	1	073180544
45	10.5	295	135,50	1	073180545
46	11	302	135,50	1	073180546
47	12	308	135,50	1	073180547
48	13	315	135,50	1	073180548

CE



S3 SRC



7320NA

Schuhe aus Nubukleder, wasserabweisend, mit abriebfester Verstärkung auf der Zehenschutzkappe

- Zehenschutzkappe aus Verbundmaterial
- Durchtrittsichere Einlage aus Verbundfaser

EU	UK	mm	€		
35	2.5	228	89,00	1	073200435
36	3.5	235	89,00	1	073200436
37	4.5	242	89,00	1	073200437
38	5	248	89,00	1	073200438
39	6	255	89,00	1	073200439
40	6.5	262	89,00	1	073200440
41	7	268	89,00	1	073200441
42	8	275	89,00	1	073200442
43	9	282	89,00	1	073200443
44	10	288	89,00	1	073200444
45	10.5	295	89,00	1	073200445
46	11	302	89,00	1	073200446
47	12	308	89,00	1	073200447
48	13	315	89,00	1	073200448

CE



S3 SRC



7321NA

Schuhe aus Nubukleder, wasserabweisend, rasch abstreifbar, mit abriebfester Verstärkung auf der Zehenschutzkappe

- Zehenschutzkappe aus Verbundmaterial
- Durchtrittsichere Einlage aus Verbundfaser

EU	UK	mm	€	W	PC
35	2,5	228	91,50	1	073210435
36	3,5	235	91,50	1	073210436
37	4,5	242	91,50	1	073210437
38	5	248	91,50	1	073210438
39	6	255	91,50	1	073210439
40	6,5	262	91,50	1	073210440
41	7	268	91,50	1	073210441
42	8	275	91,50	1	073210442
43	9	282	91,50	1	073210443
44	10	288	91,50	1	073210444
45	10,5	295	91,50	1	073210445
46	11	302	91,50	1	073210446
47	12	308	91,50	1	073210447
48	13	315	91,50	1	073210448



CE

S3 RS SRC

EN ISO 20345 2011



7322SA

Textilschuhe, hoch abriebfest, mit Fersenstütze

- Zehenschutzkappe aus Verbundmaterial
- Durchtrittsichere Einlage aus Verbundfaser

EU	UK	mm	€	W	PC
35	2,5	228	96,00	1	073220435
36	3,5	235	96,00	1	073220436
37	4,5	242	96,00	1	073220437
38	5	248	96,00	1	073220438
39	6	255	96,00	1	073220439
40	6,5	262	96,00	1	073220440
41	7	268	96,00	1	073220441
42	8	275	96,00	1	073220442
43	9	282	96,00	1	073220443
44	10	288	96,00	1	073220444
45	10,5	295	96,00	1	073220445
46	11	302	96,00	1	073220446
47	12	308	96,00	1	073220447
48	13	315	96,00	1	073220448



CE

S3 SRC

EN ISO 20345 2011



7323SA

Schnür-Textilstiefel, hoch abriebfest, rasch abstreifbar, mit Fersenstütze

- Zehenschutzkappe aus Verbundmaterial
- Durchtrittsichere Einlage aus Verbundfaser

EU	UK	mm	€	W	PC
35	2,5	228	99,00	1	073230435
36	3,5	235	99,00	1	073230436
37	4,5	242	99,00	1	073230437
38	5	248	99,00	1	073230438
39	6	255	99,00	1	073230439
40	6,5	262	99,00	1	073230440
41	7	268	99,00	1	073230441
42	8	275	99,00	1	073230442
43	9	282	99,00	1	073230443
44	10	288	99,00	1	073230444
45	10,5	295	99,00	1	073230445
46	11	302	99,00	1	073230446
47	12	308	99,00	1	073230447
48	13	315	99,00	1	073230448



CE

S3 RS SRC

EN ISO 20345 2011



 **Beta**

O-GRAVITY



7352A

Schuhe aus Mesh-Gewebe, hoch atmungsaktiv, mit TPU-Einsätzen
Fersenstütze, Stretch "Slip-on" Schuhkragen zum leichten Reinschlüpfen in den Schuh und EVA-Sohle mit hochfester Nitrilgummi-Laufsohle

- Zehenschutzkappe aus Verbundmaterial
- Durchtrittsichere Einlage aus Verbundfaser
- HÖCHSTE LEICHTIGKEIT: indikatives Gewicht Größe 42: 450 Gramm

EN ISO 20345 2011

EU	UK	mm	€		
38	5	254	147,50	1	073520038
39	6	261	147,50	1	073520039
40	6,5	268	147,50	1	073520040
41	7	274	147,50	1	073520041
42	8	281	147,50	1	073520042
43	9	288	147,50	1	073520043
44	10	294	147,50	1	073520044
45	10,5	301	147,50	1	073520045
46	11	308	147,50	1	073520046
47	12	314	147,50	1	073520047
48	13	321	147,50	1	073520048



CE

S1P HRO SRC

7352B

Schuhe aus Mesh-Gewebe, hoch atmungsaktiv, mit TPU-Einsätzen
Fersenstütze, Stretch "Slip-on" Schuhkragen zum leichten Reinschlüpfen in den Schuh und EVA-Sohle mit hochfester Nitrilgummi-Laufsohle

- Zehenschutzkappe aus Verbundmaterial
- Durchtrittsichere Einlage aus Verbundfaser
- HÖCHSTE LEICHTIGKEIT: indikatives Gewicht Größe 42: 450 Gramm

EN ISO 20345 2011

EU	UK	mm	€		
38	5	254	147,50	1	073520138
39	6	261	147,50	1	073520139
40	6,5	268	147,50	1	073520140
41	7	274	147,50	1	073520141
42	8	281	147,50	1	073520142
43	9	288	147,50	1	073520143
44	10	294	147,50	1	073520144
45	10,5	301	147,50	1	073520145
46	11	308	147,50	1	073520146
47	12	314	147,50	1	073520147
48	13	321	147,50	1	073520148



CE

S1P HRO SRC

7352G

Schuhe aus hoch atmungsaktivem Mesh-Gewebe mit TPU-Einsätzen
Fersenstütze, traditionelle Schnürsenkel und breite Passform. EVA-Sohle mit hochfester Nitrilgummi-Laufsohle

- Zehenschutzkappe aus Compound-Material
- Durchtrittsichere Einlage aus Compound-Faser
- HÖCHSTE LEICHTIGKEIT - Indikatives Gewicht Größe 42: 450 Gramm

EN ISO 20345 2011

EU	UK	mm	€		
38	5	254	152,50	1	073520338
39	6	261	152,50	1	073520339
40	6,5	268	152,50	1	073520340
41	7	274	152,50	1	073520341
42	8	281	152,50	1	073520342
43	9	288	152,50	1	073520343
44	10	294	152,50	1	073520344
45	10,5	301	152,50	1	073520345
46	11	308	152,50	1	073520346
47	12	314	152,50	1	073520347
48	13	321	152,50	1	073520348



CE

S1P HRO SRC ESD

7352LG

Damenschuhe aus Mesh-Gewebe, hoch atmungsaktiv, mit TPU-Einsätzen

Oberschuh mit speziellen Leuchtmaschen

Fersenstütze, Stretch „Slip-on“ Schuhkragen zum leichten Reinschlüpfen in den Schuh

und EVA-Sohle mit hochfester Nitrilgummi-Laufsohle

- Zehenschutzkappe aus Glasfaser
- Durchtrittssichere Einlage aus Verbundfaser
- HÖCHSTE LEICHTIGKEIT: Indikatives Gewicht Größe 38: 390 Gramm

EN ISO 20345 2011

EU	UK	mm	€		
34	2	228	152,00	1	073520234
35	2,5	234	152,00	1	073520235
36	3,5	241	152,00	1	073520236
37	4,5	248	152,00	1	073520237
38	5	254	152,00	1	073520238
39	6	261	152,00	1	073520239
40	6,5	268	152,00	1	073520240
41	7	274	152,00	1	073520241
42	8	281	152,00	1	073520242



lady



METAL FREE



CE

S1P HRO SRC

7353Y

Schuhe aus Mesh-Gewebe, hoch atmungsaktiv, mit TPU-Einsätzen

Oberteil mit speziellen Leuchtmaschen, hoch sichtbar

Fersenstütze, Stretch "Slip-on" Schuhkragen zum leichten Reinschlüpfen in den Schuh und EVA-Sohle mit hochfester Nitrilgummi-Laufsohle

- Zehenschutzkappe aus Carbonfaser
- Durchtrittssichere Einlage aus Verbundfaser
- HÖCHSTE LEICHTIGKEIT: indikatives Gewicht Größe 42: 420 Gramm

EN ISO 20345 2011

EU	UK	mm	€		
38	5	254	189,50	1	073530038
39	6	261	189,50	1	073530039
40	6,5	268	189,50	1	073530040
41	7	274	189,50	1	073530041
42	8	281	189,50	1	073530042
43	9	288	189,50	1	073530043
44	10	294	189,50	1	073530044
45	10,5	301	189,50	1	073530045
46	11	308	189,50	1	073530046
47	12	314	189,50	1	073530047
48	13	321	189,50	1	073530048



CE

S1P HRO SRC

7354N

Schuhe aus Mesh-Gewebe, wasserabweisend, mit TPU-Einsätzen

Fersenstütze, Stretch "Slip-on" Schuhkragen zum leichten Reinschlüpfen in den Schuh und EVA-Sohle mit hochfester Nitrilgummi-Laufsohle

- Zehenschutzkappe aus Verbundmaterial
- Durchtrittssichere Einlage aus Verbundfaser
- HÖCHSTE LEICHTIGKEIT: indikatives Gewicht Größe 42: 460 Gramm

EN ISO 20345 2011

EU	UK	mm	€		
38	5	254	152,00	1	073540038
39	6	261	152,00	1	073540039
40	6,5	268	152,00	1	073540040
41	7	274	152,00	1	073540041
42	8	281	152,00	1	073540042
43	9	288	152,00	1	073540043
44	10	294	152,00	1	073540044
45	10,5	301	152,00	1	073540045
46	11	308	152,00	1	073540046
47	12	314	152,00	1	073540047
48	13	321	152,00	1	073540048



METAL FREE



CE

S3 HRO SRC

7355V

Schnür-Stiefel aus Mesh-Gewebe, wasserabweisend, mit TPU-Einsätzen

Fersenstütze, Stretch "Slip-on" Schuhkragen zum leichten Reinschlüpfen in den Schuh und EVA-Sohle mit hochfester Nitrilgummi-Laufsohle

- Zehenschutzkappe aus Verbundmaterial
- Durchtrittssichere Einlage aus Verbundfaser
- HÖCHSTE LEICHTIGKEIT: indikatives Gewicht Größe 42: 465 Gramm

EN ISO 20345 2011

EU	UK	mm	€		
38	5	254	162,50	1	073550038
39	6	261	162,50	1	073550039
40	6,5	268	162,50	1	073550040
41	7	274	162,50	1	073550041
42	8	281	162,50	1	073550042
43	9	288	162,50	1	073550043
44	10	294	162,50	1	073550044
45	10,5	301	162,50	1	073550045
46	11	308	162,50	1	073550046
47	12	314	162,50	1	073550047
48	13	321	162,50	1	073550048



METAL FREE



CE

S3 HRO SRC

7356G

Schuhe aus Mikrofaser, wasserabweisend, mit TPU-Einsätzen
Fersenstütze, Stretch „Slip-on“ Schuhkragen zum leichten
Reinschlüpfen in den Schuh und EVA-Sohle mit hochfester
Nitrilgummi-Laufsohle

- Zehenschutzkappe aus Compound-Material
- Durchtrittsichere Einlage aus Compound-Faser
- HÖCHSTE LEICHTIGKEIT: indikatives Gewicht Größe 42: 460 Gramm

**EN ISO
20345
2011**

EU	UK	mm	€		
38	5	254	157,00	1	073560038
39	6	261	157,00	1	073560039
40	6,5	268	157,00	1	073560040
41	7	274	157,00	1	073560041
42	8	281	157,00	1	073560042
43	9	288	157,00	1	073560043
44	10	294	157,00	1	073560044
45	10,5	301	157,00	1	073560045
46	11	308	157,00	1	073560046
47	12	314	157,00	1	073560047
48	13	321	157,00	1	073560048



METAL
FREE



CE

S3 HRO SRC

7356V

Schuhe aus Mikrofaser, wasserabweisend, mit TPU-Einsätzen
Fersenstütze, Stretch „Slip-on“ Schuhkragen zum leichten
Reinschlüpfen in den Schuh
und EVA-Sohle mit hochfester Nitrilgummi-Laufsohle

- Zehenschutzkappe aus Verbundmaterial
- Durchtrittsichere Einlage aus Verbundfaser
- HÖCHSTE LEICHTIGKEIT: Indikatives Gewicht Größe 42: 460 Gramm

**EN ISO
20345
2011**

EU	UK	mm	€		
38	5	254	157,00	1	073560138
39	6	261	157,00	1	073560139
40	6,5	268	157,00	1	073560140
41	7	274	157,00	1	073560141
42	8	281	157,00	1	073560142
43	9	288	157,00	1	073560143
44	10	294	157,00	1	073560144
45	10,5	301	157,00	1	073560145
46	11	308	157,00	1	073560146
47	12	314	157,00	1	073560147
48	13	321	157,00	1	073560148



METAL
FREE



CE

S3 HRO SRC

7356LN

Damenschuhe aus Mikrofaser, wasserabweisend, mit
TPU-Einsätzen
Fersenstütze, Stretch „Slip-on“ Schuhkragen zum leichten
Reinschlüpfen in den Schuh
und EVA-Sohle mit hochfester Nitrilgummi-Laufsohle

- Zehenschutzkappe aus Glasfaser
- Durchtrittsichere Einlage aus Verbundfaser
- HÖCHSTE LEICHTIGKEIT: Indikatives Gewicht Größe 38: 400 Gramm

**EN ISO
20345
2011**

EU	UK	mm	€		
34	2	228	156,00	1	073560234
35	2,5	234	156,00	1	073560235
36	3,5	241	156,00	1	073560236
37	4,5	248	156,00	1	073560237
38	5	254	156,00	1	073560238
39	6	261	156,00	1	073560239
40	6,5	268	156,00	1	073560240
41	7	274	156,00	1	073560241
42	8	281	156,00	1	073560242



METAL
FREE



CE

S3 HRO SRC

7357G

Schnür-Stiefel aus Mikrofaser, wasserabweisend, mit TPU-
Einsätzen
Fersenstütze, Stretch „Slip-on“ Schuhkragen zum leichten
Reinschlüpfen in den Schuh und EVA-Sohle mit hochfester
Nitrilgummi-Laufsohle

- Zehenschutzkappe aus Compound-Material
- Durchtrittsichere Einlage aus Compound-Faser
- HÖCHSTE LEICHTIGKEIT: indikatives Gewicht Größe 42: 480 Gramm

**EN ISO
20345
2011**

EU	UK	mm	€		
38	5	254	173,50	1	073570038
39	6	261	173,50	1	073570039
40	6,5	268	173,50	1	073570040
41	7	274	173,50	1	073570041
42	8	281	173,50	1	073570042
43	9	288	173,50	1	073570043
44	10	294	173,50	1	073570044
45	10,5	301	173,50	1	073570045
46	11	308	173,50	1	073570046
47	12	314	173,50	1	073570047
48	13	321	173,50	1	073570048



METAL
FREE



CE

S3 HRO SRC

7357V

Schnür-Stiefel aus Mikrofaser, wasserabweisend, mit TPU-Einsätzen

Fersenstütze, Stretch „Slip-on“ Schuhkragen zum leichten Reinschlüpfen in den Schuh

und EVA-Sohle mit hochfester Nitrilgummi-Laufsohle

- Zehenschutzkappe aus Verbundmaterial
- Durchtrittssichere Einlage aus Verbundfaser
- HÖCHSTE LEICHTIGKEIT: Indikatives Gewicht Größe 42: 480 Gramm

EN ISO 20345 2011

EU	UK	mm	€		
38	5	254	173,50	1	073570138
39	6	261	173,50	1	073570139
40	6,5	268	173,50	1	073570140
41	7	274	173,50	1	073570141
42	8	281	173,50	1	073570142
43	9	288	173,50	1	073570143
44	10	294	173,50	1	073570144
45	10,5	301	173,50	1	073570145
46	11	308	173,50	1	073570146
47	12	314	173,50	1	073570147
48	13	321	173,50	1	073570148

CE



S3 HRO SRC



METAL FREE



7362B

Arbeitsschuhe aus Mesh-Gewebe, hoch atmungsaktiv, mit TPU-Einsätzen

Fersenstütze, Stretch „Slip-on“ Schuhkragen zum leichten Reinschlüpfen in den Schuh und EVA-Sohle mit hochfester Nitrilgummi-Laufsohle

- Ohne Zehenschutzkappe
- Ohne durchtrittssichere Einlage
- HÖCHSTE LEICHTIGKEIT: indikatives Gewicht Größe 42: 330 Gramm

EN ISO 20347 2012

EU	UK	mm	€		
39	6	261	134,00	1	073620039
40	6,5	268	134,00	1	073620040
41	7	274	134,00	1	073620041
42	8	281	134,00	1	073620042
43	9	288	134,00	1	073620043
44	10	294	134,00	1	073620044
45	10,5	301	134,00	1	073620045
46	11	308	134,00	1	073620046
47	12	314	134,00	1	073620047
48	13	321	134,00	1	073620048

CE



O1 FO HRO SRC



METAL FREE



7363N

Arbeitsschuhe aus Mesh-Gewebe, wasserabweisend, mit TPU-Einsätzen

Fersenstütze, Stretch „Slip-on“ Schuhkragen zum leichten Reinschlüpfen in den Schuh

und EVA-Sohle mit hochfester Nitrilgummi-Laufsohle

- Ohne Zehenschutzkappe
- Ohne durchtrittssichere Einlage
- HÖCHSTE LEICHTIGKEIT: indikatives Gewicht Größe 42: 330 Gramm

EN ISO 20347 2012

EU	UK	mm	€		
39	6	261	140,00	1	073630039
40	6,5	268	140,00	1	073630040
41	7	274	140,00	1	073630041
42	8	281	140,00	1	073630042
43	9	288	140,00	1	073630043
44	10	294	140,00	1	073630044
45	10,5	301	140,00	1	073630045
46	11	308	140,00	1	073630046
47	12	314	140,00	1	073630047
48	13	321	140,00	1	073630048

CE



O2 FO HRO SRC



METAL FREE



7371V

Schuhe aus sehr atmungsaktivem Mesh-Gewebe.

Fersenstütze, traditionelle Schnürung, weite Passform.

EVA-Sohle mit hochfester Nitrilgummi-Laufsohle.

- Zehenschutzkappe aus Verbundmaterial
- Durchtrittssichere Einlage aus Verbundfaser
- HÖCHSTE LEICHTIGKEIT: indikatives Gewicht Größe 42: 450 Gramm

EN ISO 20345 2022

EU	UK	mm	€		
38	5	254	152,50	1	073710038
39	6	261	152,50	1	073710039
40	6,5	268	152,50	1	073710040
41	7	274	152,50	1	073710041
42	8	281	152,50	1	073710042
43	9	288	152,50	1	073710043
44	10	294	152,50	1	073710044
45	10,5	301	152,50	1	073710045
46	11	308	152,50	1	073710046
47	12	314	152,50	1	073710047
48	13	321	152,50	1	073710048

CE



S1PS HRO FO SR ESD



METAL FREE



7372B

Schuhe aus festem und sehr atmungsaktivem geflochtenem Gewebe.

Fersenstütze, traditionelle Schnürsenkel und breite Passform. EVA-Sohle mit hochfester Nitrilgummi-Laufsohle.

- Zehenschutzkappe aus Compound-Material
- Durchtrittsichere Einlage aus Compound-Faser
- HÖCHSTE LEICHTIGKEIT: Ungefähres Gewicht Größe 42: 450 Gramm

EN ISO 20345 2011

EU	UK	mm	€		
38	5	254	156,00	1	073720038
39	6	261	156,00	1	073720039
40	6,5	268	156,00	1	073720040
41	7	274	156,00	1	073720041
42	8	281	156,00	1	073720042
43	9	288	156,00	1	073720043
44	10	294	156,00	1	073720044
45	10,5	301	156,00	1	073720045
46	11	308	156,00	1	073720046
47	12	314	156,00	1	073720047
48	13	321	156,00	1	073720048

CE



S1P HRO SRC



7376A

Sandalen aus perforierter Mikrofaser und hoch atmungsaktivem Mesh-Gewebe

Fersenstütze, traditionelle Schnürung, mit Stretch-Schnürsenkeln, breite Passform.

EVA-Sohle mit hochfester Nitrilgummi-Laufsohle.

- Zehenschutzkappe aus Compound-Material
- Durchtrittsichere Einlage aus Compound-Faser
- HÖCHSTE LEICHTIGKEIT: Ungefähres Gewicht Größe 42: 490 Gramm

EN ISO 20345 2011

EU	UK	mm	€		
38	5	254	158,00	1	073760038
39	6	261	158,00	1	073760039
40	6,5	268	158,00	1	073760040
41	7	274	158,00	1	073760041
42	8	281	158,00	1	073760042
43	9	288	158,00	1	073760043
44	10	294	158,00	1	073760044
45	10,5	301	158,00	1	073760045
46	11	308	158,00	1	073760046
47	12	314	158,00	1	073760047
48	13	321	158,00	1	073760048

CE



S1P HRO SRC



7381N

Wasserdichte Schuhe aus besonders abriebfestem Gewebe mit TPU-Einsätzen. Fersenstütze, traditionelle Schnürsenkel und großzügige Passform. EVA-Sohle mit hochfester Nitrilgummi-Laufsohle.

- Zehenschutzkappe aus Compound-Material
- Durchtrittsichere Einlage aus Compound-Faser
- Wasserdichte Membran Beta TECH mit „Bootie“-System
- LEICHT: Indikatives Gewicht Größe 42: 500 Gramm

EN ISO 20345 2011

EU	UK	mm	€		
38	5	254	181,00	1	073810038
39	6	261	181,00	1	073810039
40	6,5	268	181,00	1	073810040
41	7	274	181,00	1	073810041
42	8	281	181,00	1	073810042
43	9	288	181,00	1	073810043
44	10	294	181,00	1	073810044
45	10,5	301	181,00	1	073810045
46	11	308	181,00	1	073810046
47	12	314	181,00	1	073810047
48	13	321	181,00	1	073810048

CE



S3 SRC HRO WR



7382N

Wasserdichte Schnür-Stiefel aus besonders abriebfestem Gewebe mit TPU-Einsätzen. Fersenstütze, traditionelle Schnürsenkel und großzügige Passform. EVA-Sohle mit hochfester Nitrilgummi-Laufsohle.

- Zehenschutzkappe aus Compound-Material
- Durchtrittsichere Einlage aus Compound-Faser
- Wasserdichte Membran Beta TECH mit „Bootie“-System
- LEICHT: Indikatives Gewicht Größe 42: 550 Gramm

EN ISO 20345 2011

EU	UK	mm	€		
38	5	254	203,00	1	073820038
39	6	261	203,00	1	073820039
40	6,5	268	203,00	1	073820040
41	7	274	203,00	1	073820041
42	8	281	203,00	1	073820042
43	9	288	203,00	1	073820043
44	10	294	203,00	1	073820044
45	10,5	301	203,00	1	073820045
46	11	308	203,00	1	073820046
47	12	314	203,00	1	073820047
48	13	321	203,00	1	073820048

CE



S3 SRC HRO WR



HEAVY DUTY



7293HM

Schuhe aus vollnarbigem, gefettetem Leder, wasserabweisend, mit Laufssole aus hochleistungsfähigem VIBRAM® Gummi, Abriebschutz an der Ferse und verstärkter Überkappe aus Polyurethan

- Zehenschutzkappe aus Glasfaser
- Durchtrittsichere Einlage aus Verbundfaser

EN ISO 20345 2011



EU	UK	mm	€	W	W
39	6	263	203,00	1	072930639
40	6,5	270	203,00	1	072930640
41	7	276	203,00	1	072930641
42	8	283	203,00	1	072930642
43	9	289	203,00	1	072930643
44	10	296	203,00	1	072930644
45	10,5	302	203,00	1	072930645
46	11	309	203,00	1	072930646
47	12	315	203,00	1	072930647
48	13	322	203,00	1	072930648

CE



S3 HRO HI SRC

7294HM

Schnür-Stiefel aus vollnarbigem, gefettetem Leder, wasserabweisend, mit Laufssole aus hochleistungsfähigem VIBRAM® Gummi, Abriebschutz an der Ferse und verstärkter Überkappe aus Polyurethan

- Zehenschutzkappe aus Glasfaser
- Durchtrittsichere Einlage aus Verbundfaser

EN ISO 20345 2011

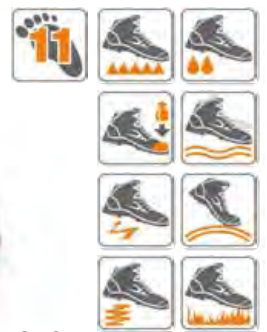

EU	UK	mm	€	W	W
39	6	263	214,50	1	072940639
40	6,5	270	214,50	1	072940640
41	7	276	214,50	1	072940641
42	8	283	214,50	1	072940642
43	9	289	214,50	1	072940643
44	10	296	214,50	1	072940644
45	10,5	302	214,50	1	072940645
46	11	309	214,50	1	072940646
47	12	315	214,50	1	072940647
48	13	322	214,50	1	072940648

CE



S3 HRO HI SRC

7294HMC

Schnür-Stiefel aus vollnarbigem, gefettetem Leder, wasserabweisend, mit Laufssole aus hochleistungsfähigem VIBRAM® Gummi, Abriebschutz an der Ferse und verstärkter Überkappe aus Polyurethan. Mit Tepor Membran, waterproof, windfest und extrem atmungsaktiv

- Zehenschutzkappe aus Glasfaser
- Durchtrittsichere Einlage aus Verbundfaser

EN ISO 20345 2011



EU	UK	mm	€	W	W
39	6	263	239,00	1	072940739
40	6,5	270	239,00	1	072940740
41	7	276	239,00	1	072940741
42	8	283	239,00	1	072940742
43	9	289	239,00	1	072940743
44	10	296	239,00	1	072940744
45	10,5	302	239,00	1	072940745
46	11	309	239,00	1	072940746
47	12	315	239,00	1	072940747
48	13	322	239,00	1	072940748

CE



S3 HRO HI CI WR SRC

ACCESSORIES

7398 0/G

Anatomisch geformte Einlegesohlen aus EVA-Schaum mit Dämpfkissen im Fersenbereich
(empfohlener Ersatz für die Schuhlinie 0-Gravity)



EU	UK	€		
38	5	8,30	1	073981238
39	6	8,30	1	073981239
40	6,5	8,30	1	073981240
41	7	8,30	1	073981241
42	8	8,30	1	073981242
43	9	8,30	1	073981243
44	10	8,30	1	073981244
45	10,5	8,30	1	073981245
46	11	8,30	1	073981246
47	12	8,30	1	073981247
48	13	8,30	1	073981248

7398ESD

Anatomisch geformte, atmungsaktive Einlegesohle, antibakterielle Oberschicht, geruchsneutral.
Ersatzteil für Schuhe mit ESD (ElectroStatic Discharge) Zertifizierung



EU	UK	€		
35	2,5	9,50	1	073981435
36	3,5	9,50	1	073981436
37	4,5	9,50	1	073981437
38	5	9,50	1	073981438
39	6	9,50	1	073981439
40	6,5	9,50	1	073981440
41	7	9,50	1	073981441
42	8	9,50	1	073981442
43	9	9,50	1	073981443
44	10	9,50	1	073981444
45	10,5	9,50	1	073981445
46	11	9,50	1	073981446
47	12	9,50	1	073981447
48	13	9,50	1	073981448

7398T

Anatomisch geformte Einlegesohlen mit Wärmeisolierung WINTHERM. 70% aluminisiertes Polyester, 30% Polyethylen, gekoppelt mit Vliesstoff in Synthetikfasern. Antistatisch, atmungsaktiv, schnelle Adsorption, geruchsfrei, antibakteriell, antimykotisch.



WINTHERM

EU	UK	€		
35	2,5	16,50	1	073981335
36	3,5	16,50	1	073981336
37	4,5	16,50	1	073981337
38	5	16,50	1	073981338
39	6	16,50	1	073981339
40	6,5	16,50	1	073981340
41	7	16,50	1	073981341
42	8	16,50	1	073981342
43	9	16,50	1	073981343
44	10	16,50	1	073981344
45	10,5	16,50	1	073981345
46	11	16,50	1	073981346
47	12	16,50	1	073981347
48	13	16,50	1	073981348

7398U

Anatomisch geformte TPR GEL-Einlegesohlen mit hoher Dämpfungswirkung, Fußbettstütze und Polster im Fersenbereich



EU	UK	€		
36 - 40	3,5 - 6,5	15,30	1	073980058
41 - 46	7 - 11	15,30	1	073980063

7398UP

Anatomische geformte TPE GEL-Einlegesohlen mit Zitrusduft, Fußbettstütze



EU	UK	€		
36 - 40	3,5 - 6	13,90	1	073980076
41 - 46	7 - 11	13,90	1	073980081

7398GEL

Anatomisch geformte Einlegesohlen mit Geleinsatz



EU	UK	€		
35	2,5	5,20	1	073980835
36	3,5	5,20	1	073980836
37	4,5	5,20	1	073980837
38	5	5,20	1	073980838
39	6	5,20	1	073980839
40	6,5	5,20	1	073980840
41	7	5,20	1	073980841
42	8	5,20	1	073980842
43	9	5,20	1	073980843
44	10	5,20	1	073980844
45	10,5	5,20	1	073980845
46	11	5,20	1	073980846
47	12	5,20	1	073980847
48	13	5,20	1	073980848

7398EF

Anatomisch geformte Einlegesohlen aus Polyurethan-Schaum, mit stoßdämpfendem Einsatz im Fersenbereich



EU	UK	€		
35	2,5	9,70	1	073981135
36	3,5	9,70	1	073981136
37	4,5	9,70	1	073981137
38	5	9,70	1	073981138
39	6	9,70	1	073981139
40	6,5	9,70	1	073981140
41	7	9,70	1	073981141
42	8	9,70	1	073981142
43	9	9,70	1	073981143
44	10	9,70	1	073981144
45	10,5	9,70	1	073981145
46	11	9,70	1	073981146
47	12	9,70	1	073981147
48	13	9,70	1	073981148

7399 A/N...

Packung mit 10 Paar Schnürsenkeln



cm	€		
100	18,20	1	073990010
120	21,40	1	073990012
140	26,00	1	073990017

Die angegebenen Preise beziehen sich auf 10 Paar

7421

Lange Strümpfe aus elastokompressivem Frottee mit Verstärkungen aus Nylon und Baumwolle an Spitze und Ferse
Fußsohle aus Bambusfaser, widerstandsfähig, antimykotisch und atmungsaktiv



EU	€		
M 39-42	19,30	1	074210002
L 43-46	19,30	1	074210004

7422P

Kurze Socken aus recyceltem Baumwollfrottee, mit Zehen- und Fersenbereich aus Frottee und „Tremor“-Effekt
2 Paar

Farbvarianten:
schwarz mit grauen, orangefarbenen und braunen Einsätzen
grau mit schwarzen, orangefarbenen und braunen Einsätzen



EU	€		
M 39-42	16,80	1	074220102
L 43-46	16,80	1	074220104

7425

Kurze Strümpfe mit atmungsaktiven Texture-Einsätzen und Verstärkungen aus Nylon/Baumwolle an Spitze und Ferse
Strumpfsohle aus Nylon verflechtet mit Bambusfaser, widerstandsfähig, antimykotisch und atmungsaktiv



EU	€		
M 39-42	12,70	1	074250002
L 43-46	12,70	1	074250004

7426P

Maxi-Sneakersocken aus recycelter Baumwolle mit Lauffläche aus Baumwollfrottee, Zehen- und Fersenbereich mit „Tremor“-Effekt
2 Paar

Farbvarianten:
grau mit schwarzen und leuchtend blauen Einsätzen
schwarz mit leuchtend blauen und grauen Einsätzen



EU	€		
M 39-42	15,60	1	074260102
L 43-46	15,60	1	074260104

7427

Maxi Sneaker Strümpfe mit atmungsaktiven Schutz-Einsätzen am Schienbein und am Spann
Verstärkungen aus Nylon und Baumwolle an der Spitze und an der Ferse, Strumpfsohle in Bambusfaser, widerstandsfähig, antimykotisch und atmungsaktiv



EU	€		
M 39-42	10,70	1	074270002
L 43-46	10,70	1	074270004

7430T

Sneakersocken aus recycelter Baumwolle mit Lauffläche aus Frottee, Zehen- und Fersenbereich mit „Tremor“-Effekt
3 Paar
Farbvarianten:
grau meliert mit schwarzen und bordeauxroten Einsätzen
schwarz mit grauen Einsätzen
grau meliert mit schwarzen Einsätzen

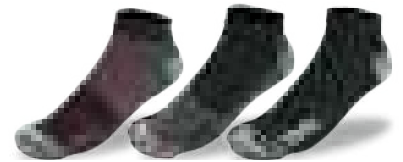

EU	€		
M 39-42	20,10	1	074300202
L 43-46	20,10	1	074300204

7431P

Zwei Paar Sneaker Strümpfe mit atmungsaktiven Texture-Einsätzen und Verstärkungen aus Nylon/Baumwolle an Zehen und Ferse

Strumpfsohle aus Nylon verflechtet mit Bambusfaser, widerstandsfähig, antimykotisch und atmungsaktiv.
Ein Paar schwarz/orangefarben und ein Paar schwarz/grau



EU	€		
M 39-42	9,50	1	074310102
L 43-46	9,50	1	074310104

WORKWEAR



Die Arbeitsbekleidungsline hat im Verlauf der Jahre das Vertrauen anspruchsvollster Facharbeiter gewonnen und wird heute von diesen bevorzugt gekauft.

Der Erfolg des Produkts hat zu einer kontinuierlichen Entwicklung und Erweiterung des Angebotsortiments geführt.

Die von Beta Utensili S.p.a. produzierte Bekleidung entspricht folgender Norm:

EN ISO 13688:2013

Die persönliche Schutzausrüstung schützt den Träger vor körperlichen Gefahren geringen Ausmaßes wie: kleine Hautabschürfungen, Sonnenstrahlen, Wind, Kälte, ungiftige Stäube und Beschmutzung durch ungiftige Materialien. Dieser Schutz ist auf die erste Kategorie des Gesetzentwurfs Nr. 475 vom 04.12.1992 zurückführbar.

ANLEITUNGEN FÜR DIE VERWENDUNG UND AUFBEWAHRUNG

Das Kleidungsstück ist korrekt anzuziehen, sodass es die Körperpartien des Trägers schützen kann. Das Kleidungsstück ist an einem frischen, trockenen Ort in seiner Originalverpackung, geschützt vor Wärmequellen, Sonnenstrahlen, Staub und Witterungseinflüssen aufzubewahren.

EINLAUFEN

Alle Naturfasern gehen beim Waschen im Wasser ein. Die Einlaufquote variiert in Abhängigkeit unterschiedlicher Parameter und insbesondere der Faserart und Wassertemperatur von 1 % bis 5 %.

GRÖSSENTABELLE

		HERREN						DAMEN							
		I	F	D	E	UK	USA	I	F	D	E	UK	USA		
HERREN	XS	46	38	42	40	30	32	DAMEN	XS	38	34	32	34	6	2
	S	48	40	44	42	32	34		S	40	36	34	36	8	4
	M	50	42	46	44	34	36		M	42	38	36	38	10	6
	L	52	44	48	46	36	38		L	44	40	38	40	12	8
	XL	54	46	50	48	38	40		XL	46	42	40	42	14	10
	2XL	56	48	52	50	40	42		2XL	48	44	42	44	16	12
3XL	58	50	54	52	42	44	3XL	50	46	44	46	18	14		
4XL	60	52	56	54	44	46									
5XL	62	54	58	56	46	48									

KÖRPERMASSE EN ISO 13688:2013

		HERREN									
		XS	S	M	L	XL	2XL	3XL	4XL	5XL	
A	88-92	92-96	96-104	104-108	108-116	116-124	124-132	132-140	140-148		
B	79-83	83-87	87-91	91-95	95-100	100-107	107-112	112-120	120-128		
H	158-164	164-170	170-176	176-182	182-188	188-194	194-200	200-206	206-212		

		DAMEN							
		XS	S	M	L	XL	2XL	3XL	
B	72-77	77-82	82-87	87-93	93-99	99-105	105-111		
H	162-165	164-167	168-171	170-173	172-175	174-177	176-179		

LEITFADEN ZUR WAHL VON BEKLEIDUNG PREISLISTE 2024

Kategorie	Linie	Artikel-Nr.	S.	Farbe	Empfohlene Kombinationen (gleiches Gewebe und Farbe zur Hose)										
					Shorts	S.	Latzhose	S.	Overall	S.	Weste	Page	Jacke	S.	
LEICHTE ARBEITSHOSEN	7610G	Trekking	653	■	7611G	657									
	7610N		653	■											
	7660B	Top Line	653	■	7661B	657									
	7660G		653	■	7661G	657									
	7830SN	Stretch	654	■	7831SN	657									
	7860G	Beta Easy	655	■	7861G	658	7863G	658	7865G	659	7867G	661	7869G	660	
	7860B		655	■	7861B	658			7865B	659	7867B	661			
	7930MG	Cotton	656	■	7931MG	658			7935MG	659	7937MG	662			
GANZJAHR ARBEITSHOSEN	7600G	Trekking	652	■											
	7600N		652	■											
	7650	Top Line	653	■									7653G	660	
	7650B		653	■											
	7818BL		654	■											
	7818CM		654	■	7815CM	657									
	7818G		654	■											
	7819G		654	■											
	7830ST	Stretch	655	■	7831ST	657									
	7840BL	Beta Easy	655	■									7849BL	660	
	7850G		655	■											
	7880SC	Stretch	655	■											
	7900B		656	■									7909B	660	
	7900G	Beta Easy	656	■	7901G	658	7903G	659	7905G	659	7907G	662	7909G	660	
	7900P		656	■			7903P	659					7909P	660	
7900V	656		■									7909V	660		
7940	Multischutz	656	■									7949	661		
7818LN	Lady	654	■												

LEITFADEN ZUR WAHL VON BEKLEIDUNG PREISLISTE 2024

Kategorie	Linie	Artikel-Nr.	S.	Farbe	Empfohlene Kombinationen (gleiches Gewebe und Farbe zur Hose)									
					Shorts	S.	Latzhose	S.	Overall	S.	Weste	Page	Jacke	S.
ARBEITSJEANS	7530		652											
	7528		652		7529	657								
	7527		652											
POLO SHIRTS	7547AZ		664		KOMBINIERBAR MIT ALLEN ANDEREN KLEIDUNGSSTÜCKEN JE NACH FARBKOMBINATION									
	7547BL		665											
	7547G		665											
	7547N		665											
	7547R		665											
	7557BL		666											
T-SHIRTS	7548M		665		KOMBINIERBAR MIT ALLEN ANDEREN KLEIDUNGSSTÜCKEN JE NACH FARBKOMBINATION									
	7548C		665											
	7549AZ		665											
	7549BL		665											
	7549G		665											
	7549N		666											
	7549NE		666											
	7549R		666											
	7550G	Top Line	666											
	7550N	Top Line	666											
HEMDEN	7545F		664											
SWEATSHIRTS	7637G		663		KOMBINIERBAR MIT ALLEN ANDEREN KLEIDUNGSSTÜCKEN JE NACH FARBKOMBINATION									
	7642G		663											
	7664G	Top Line	664											
	7664N		664											
	7665G		664											
	7665N		664											
FLEECE- und MIKROFLEECE PULLOVER	7636N		663		KOMBINIERBAR MIT ALLEN ANDEREN KLEIDUNGSSTÜCKEN JE NACH FARBKOMBINATION									
	7654B	Top Line	663											
	7654N		664											
	7657B		664											
	7657N		667											
WESTEN	7575N		661		KOMBINIERBAR MIT ALLEN ANDEREN KLEIDUNGSSTÜCKEN JE NACH FARBKOMBINATION									
	7579QN		661											
	7673NG	Top Line	661											
JACKEN UND SOFTSHELL	7658CM	Top Line	662		KOMBINIERBAR MIT ALLEN ANDEREN KLEIDUNGSSTÜCKEN JE NACH FARBKOMBINATION									
	7659N		662											
	7669N		662											
WATTIERTE JACKEN	7670G	Top Line	662		KOMBINIERBAR MIT ALLEN ANDEREN KLEIDUNGSSTÜCKEN JE NACH FARBKOMBINATION									
	7674NG		663											
	7780QN		663											
	7750N		663											

LEITFADEN ZUR WAHL VON BEKLEIDUNG PREISLISTE 2024

Kategorie	Linie	Artikel-Nr.	S.	Farbe	Empfohlene Kombinationen (gleiches Gewebe und Farbe zur Hose)									
					Shorts	S.	Latzhose	S.	Overall	S.	Weste	Page	Jacke	S.
REGENSCHUTZKLEIDUNG	7970	Hose	666										7979	667
	7971L	Hose	667										7978L	667
	7981N	Regenkappe	668											
ACCESSORIES	7980NC	Mütze	668		KOMBINIERBAR MIT ALLEN ANDEREN KLEIDUNGSSTÜCKEN JE NACH FARBKOMBINATION									
	7980RN	Mütze	668											
	7980L	Mütze mit Licht	668											
	7982N	Kappe	668											
	7984EG	Gürtel	668											
	7984G	Gürtel	668											
	7985N	Halswärmer	668											
	7996N	Techno-Unterwäsche Set	667											

PANTS



7527

Arbeitsjeans
aus 70 % Baumwolle, 27 % Polyester und 3%
Stretchgewebe
Normale Passform

CE

Jeans



Größe	I	€	U	Art-Nr.
XS	46	61,50	1	075270046
S	48	61,50	1	075270048
M	50	61,50	1	075270050
L	52	61,50	1	075270052
XL	54	61,50	1	075270054
XXL	56	61,50	1	075270056
XXXL	58	61,50	1	075270058

7528

Stretch-Arbeitsjeans
aus 98% Baumwolle und 2% Stretch-Gewebe,
figurbetonte Passform

CE

Jeans



Größe	I	€	U	Art-Nr.
XS	46	67,50	1	075280046
S	48	67,50	1	075280048
M	50	67,50	1	075280050
L	52	67,50	1	075280052
XL	54	67,50	1	075280054
XXL	56	67,50	1	075280056
XXXL	58	67,50	1	075280058

7530

Stretch-Arbeitsjeans
98% Baumwolle und 2% Stretchgewebe, mit
Verstärkungen aus Polyester
Figurbetonte Passform

CE

Jeans



Größe	I	€	U	Art-Nr.
XS	46	79,50	1	075300046
S	48	79,50	1	075300048
M	50	79,50	1	075300050
L	52	79,50	1	075300052
XL	54	79,50	1	075300054
XXL	56	79,50	1	075300056
XXXL	58	79,50	1	075300058

7600G

„Work Trekking“-Hose HEAVY
90% Nylon, 10% Stretchgewebe, 265 g/m²,
Verstärkungen im Knie- und Gesäßbereich,
Hosensaum aus Stretchgewebe mit
senkrechtem Reißverschluss
Dunkelgrau mit neongrünen Details
Figurbetonte Passform

CE

TREKKING
HEAVY



Größe	I	€	U	Art-Nr.
XS	46	82,50	1	076000000
S	48	82,50	1	076000001
M	50	82,50	1	076000002
L	52	82,50	1	076000003
XL	54	82,50	1	076000004
XXL	56	82,50	1	076000005
XXXL	58	82,50	1	076000006

7600N

„Work Trekking“-Hose HEAVY
90% Nylon, 10% Stretchgewebe, 265 g/m²,
Verstärkungen im Knie- und Gesäßbereich,
Hosensaum aus Stretchgewebe mit
senkrechtem Reißverschluss
Schwarz mit neongrünen Details
Figurbetonte Passform

CE

TREKKING
HEAVY



Größe	I	€	U	Art-Nr.
XS	46	82,50	1	076000100
S	48	82,50	1	076000101
M	50	82,50	1	076000102
L	52	82,50	1	076000103
XL	54	82,50	1	076000104
XXL	56	82,50	1	076000105
XXXL	58	82,50	1	076000106

7610G

Arbeitschhose "Work Trekking" LIGHT
90 % Nylon, 10 % Stretchgewebe, 140 g/m²,
r#ckseitig und Knie verst#rkt, elastische und
verstellbare Beinabschl#sse mit Kordelzug
Dunkelgrau mit gelben Details
Figurbetonte Passform

CE

TREKING
LIGHT



Gr#sse	I	€	St#ck	Art-Nr.
XS	46	80,50	1	076100000
S	48	80,50	1	076100001
M	50	80,50	1	076100002
L	52	80,50	1	076100003
XL	54	80,50	1	076100004
XXL	56	80,50	1	076100005
XXXL	58	80,50	1	076100006

7650

Dehnbare Mehrtaschen-Arbeitschhose
90% Nylon -10% Spandex, 260 g/m²,
anthrazitgrau
Knieschonertaschen, Taschen hinten und
Beinsaum mit Verst#rkungen aus Polyester
600D, reissfester Schritt

CE



Gr#sse	I	€	St#ck	Art-Nr.
XS	46	104,50	1	076500000
S	48	104,50	1	076500001
M	50	104,50	1	076500002
L	52	104,50	1	076500003
XL	54	104,50	1	076500004
XXL	56	104,50	1	076500005
XXXL	58	104,50	1	076500006

7660B

Mehrtaschen-Arbeitschhose aus Stretch-
Gewebe, leichte Ausf#hrung,
86% Nylon - 14% Spandex, 140 g/m², blau
Knieschonertaschen, Taschen hinten mit
Verst#rkungen aus Polyester 300D, reissfester
Schritt
Slim Fit

CE



Gr#sse	I	€	St#ck	Art-Nr.
XS	46	90,00	1	076600100
S	48	90,00	1	076600101
M	50	90,00	1	076600102
L	52	90,00	1	076600103
XL	54	90,00	1	076600104
XXL	56	90,00	1	076600105
XXXL	58	90,00	1	076600106

7610N

Arbeitschhose "Work Trekking" LIGHT
90 % Nylon, 10 % Stretchgewebe, 140 g/m²,
r#ckseitig und Knie verst#rkt, elastische und
verstellbare Beinabschl#sse mit Kordelzug
Schwarz mit gelben Details
Figurbetonte Passform

CE

TREKING
LIGHT



Gr#sse	I	€	St#ck	Art-Nr.
XS	46	80,50	1	076100100
S	48	80,50	1	076100101
M	50	80,50	1	076100102
L	52	80,50	1	076100103
XL	54	80,50	1	076100104
XXL	56	80,50	1	076100105
XXXL	58	80,50	1	076100106

7650B

Dehnbare Mehrtaschen-Arbeitschhose
90% Nylon - 10% Spandex, 260 g/m², blau
Knieschonertaschen, Taschen hinten und
Beinsaum mit Verst#rkungen aus Polyester
600D, reissfester Schritt

CE



Gr#sse	I	€	St#ck	Art-Nr.
XS	46	104,50	1	076500100
S	48	104,50	1	076500101
M	50	104,50	1	076500102
L	52	104,50	1	076500103
XL	54	104,50	1	076500104
XXL	56	104,50	1	076500105
XXXL	58	104,50	1	076500106

7660G

Mehrtaschen-Arbeitschhose, leichte Ausf#hrung,
aus Stretch-Gewebe -
86% Nylon - 14% Spandex, 140 g/m²,
anthrazitgrau Knieschonertaschen, Taschen
hinten mit Verst#rkungen aus Polyester 300D,
reissfester Schritt
Slim Fit

CE



Gr#sse	I	€	St#ck	Art-Nr.
XS	46	90,00	1	076600000
S	48	90,00	1	076600001
M	50	90,00	1	076600002
L	52	90,00	1	076600003
XL	54	90,00	1	076600004
XXL	56	90,00	1	076600005
XXXL	58	90,00	1	076600006

7818G

Mehrtaschen-Arbeitschse aus T/C Canvas 260 g/m², grau
Knieschonertaschen und Beine unten mit Verstärkungen aus Polyester 300D, reißfester Schritt und Einsatz aus Stretch-Gewebe am Innenbein und im Lendenbereich für höhere Bewegungsfreiheit

CE



Größe	I	€	CE	Info
XS	46	80,50	1	078180000
S	48	80,50	1	078180001
M	50	80,50	1	078180002
L	52	80,50	1	078180003
XL	54	80,50	1	078180004
XXL	56	80,50	1	078180005
XXXL	58	80,50	1	078180006

7818BL

Mehrtaschen-Arbeitschse aus T/C Canvas, 260 g/m², blau Mit Einsatz aus Stretch-Gewebe am Innenbein und im Lendenbereich Knieschonertaschen und Beine unten mit Verstärkungen aus Polyester 300D, reißfester Schritt und Einsatz aus Stretch-Gewebe am Innenbein und im Lendenbereich für höhere Bewegungsfreiheit

CE



Größe	I	€	CE	Info
XS	46	80,50	1	078180100
S	48	80,50	1	078180101
M	50	80,50	1	078180102
L	52	80,50	1	078180103
XL	54	80,50	1	078180104
XXL	56	80,50	1	078180105
XXXL	58	80,50	1	078180106

7818CM

Mehrtaschen-Arbeitschse aus T/C Canvas, 260 g/m², Camouflage grau
Knieschonertaschen und Beinabschlüsse mit Verstärkungen aus Polyester 300D, reißfester Schritt und Einsatz aus Stretchgewebe am Innenbein und im Lendenbereich für höhere Bewegungsfreiheit

CE



Größe	I	€	CE	Info
XS	46	85,00	1	078180300
S	48	85,00	1	078180301
M	50	85,00	1	078180302
L	52	85,00	1	078180303
XL	54	85,00	1	078180304
XXL	56	85,00	1	078180305
XXXL	58	85,00	1	078180306

7818LN

Mehrtaschen-Damenarbeitschse, schwarz, mit rosafarbenen Einsätzen 100% Stretch-Gewebe, 220 g/m² Knieschonertaschen und Beine unten mit Verstärkungen aus Polyester 300D, reißfester Schritt und Einsatz aus Stretch-Gewebe am Innenbein für höhere Bewegungsfreiheit

CE

lady



Größe	I	€	CE	Info
XS	38	80,50	1	078180200
S	40	80,50	1	078180201
M	42	80,50	1	078180202
L	44	80,50	1	078180203
XL	46	80,50	1	078180204
XXL	48	80,50	1	078180205
XXXL	50	80,50	1	078180206

7819G

Mehrtaschen-Arbeitschse mit abnehmbaren Hängetaschen, aus T/C Canvas 260 g/m², grau Knieschonertaschen und Beinabschluss mit Verstärkungen aus Polyester 300D, reißfester Schritt und Einsatz aus Stretch-Gewebe am Innenbein und im Lendenbereich für höhere Bewegungsfreiheit

CE



Größe	I	€	CE	Info
XS	46	80,50	1	078190000
S	48	80,50	1	078190001
M	50	80,50	1	078190002
L	52	80,50	1	078190003
XL	54	80,50	1	078190004
XXL	56	80,50	1	078190005
XXXL	58	80,50	1	078190006

7830SN

Stretch-Arbeitschse aus T/C Twill, 200 g/m², schwarz Figurbetonte Passform, reißfester Schritt und Stretch-Einsätze an den Taillenseiten

CE



Größe	I	€	CE	Info
XS	46	71,50	1	078300100
S	48	71,50	1	078300101
M	50	71,50	1	078300102
L	52	71,50	1	078300103
XL	54	71,50	1	078300104
XXL	56	71,50	1	078300105
XXXL	58	71,50	1	078300106

7830ST

Dehnbare Arbeitshose
aus T/C Twill, 250 g/m², grau
Figurbetonte Passform, reißfester Schritt und
Stretch-Einsätze an den Taillenseiten

CE



	I	€		
XS	46	71,50	1	078300000
S	48	71,50	1	078300001
M	50	71,50	1	078300002
L	52	71,50	1	078300003
XL	54	71,50	1	078300004
XXL	56	71,50	1	078300005
XXXL	58	71,50	1	078300006

7840BL

Arbeitshose aus T/C Twill, 245 g/m², blau,
Stretch-Einsätze an den Taillenseiten

CE

Beta EASY



	I	€		
XS	46	46,00	1	078400100
S	48	46,00	1	078400101
M	50	46,00	1	078400102
L	52	46,00	1	078400103
XL	54	46,00	1	078400104
XXL	56	46,00	1	078400105
XXXL	58	46,00	1	078400106
XXXXL	60	46,00	1	078400107

7850G

Cargo-Arbeitshose,
100 % Baumwolle, 240 g/m²,
elastischer Bund an den Seiten und
Seitentaschen mit Reflexeinsätzen,
grau mit neongrünen Details
schlanke Passform

CE



	I	€		
XS	46	52,00	1	078500100
S	48	52,00	1	078500101
M	50	52,00	1	078500102
L	52	52,00	1	078500103
XL	54	52,00	1	078500104
XXL	56	52,00	1	078500105
XXXL	58	52,00	1	078500106
XXXXL	60	52,00	1	078500107

7860B

Arbeitshose, leichte Ausführung,
aus T/C Twill, 180 g/m², mit Oxford-Einsätzen,
blau

CE



	I	€		
XS	46	60,00	1	078600700
S	48	60,00	1	078600701
M	50	60,00	1	078600702
L	52	60,00	1	078600703
XL	54	60,00	1	078600704
XXL	56	60,00	1	078600705
XXXL	58	60,00	1	078600706
XXXXL	60	60,00	1	078600707
5XL	62	60,00	1	078600708

7860G

Arbeitshose, leichte Ausführung,
aus T/C Twill, 180 g/m², mit Einsätzen aus
Oxford, grau
Neues Design - Bessere Passform

CE

Beta EASY

LIGHT



	I	€		
XS	46	60,00	1	078600800
S	48	60,00	1	078600801
M	50	60,00	1	078600802
L	52	60,00	1	078600803
XL	54	60,00	1	078600804
XXL	56	60,00	1	078600805
XXXL	58	60,00	1	078600806
XXXXL	60	60,00	1	078600807
5XL	62	60,00	1	078600808

7880SC

Dehnbare Arbeitshose
aus T/C Canvas, 290 g/m², schwarz
Figurbetonte Passform, reißfester Schritt und
Stretch-Einsätze an den Taillenseiten

CE



	I	€		
XS	46	72,50	1	078800000
S	48	72,50	1	078800001
M	50	72,50	1	078800002
L	52	72,50	1	078800003
XL	54	72,50	1	078800004
XXL	56	72,50	1	078800005
XXXL	58	72,50	1	078800006

7900B

Arbeitschse
aus T/C Canvas, 260 g/m², mit Einsätzen aus
Oxford, blau

CE

Beta EASY



Größe	I	€	Stück	Artikelnummer
XS	46	65,50	1	079000700
S	48	65,50	1	079000701
M	50	65,50	1	079000702
L	52	65,50	1	079000703
XL	54	65,50	1	079000704
XXL	56	65,50	1	079000705
XXXL	58	65,50	1	079000706
XXXXL	60	65,50	1	079000707

7900G

Arbeitschse
aus T/C Canvas, 260 g/m², mit Einsätzen aus
Oxford, grau
Neues Design - Bessere Passform

CE

Beta EASY



Größe	I	€	Stück	Artikelnummer
XS	46	65,50	1	079000800
S	48	65,50	1	079000801
M	50	65,50	1	079000802
L	52	65,50	1	079000803
XL	54	65,50	1	079000804
XXL	56	65,50	1	079000805
XXXL	58	65,50	1	079000806
XXXXL	60	65,50	1	079000807

7900P

Arbeitschse
aus T/C Canvas, 260 g/m², mit Einsätzen aus
Oxford, petrolblau

CE

Beta EASY



Größe	I	€	Stück	Artikelnummer
XS	46	65,50	1	079000600
S	48	65,50	1	079000601
M	50	65,50	1	079000602
L	52	65,50	1	079000603
XL	54	65,50	1	079000604
XXL	56	65,50	1	079000605
XXXL	58	65,50	1	079000606
XXXXL	60	65,50	1	079000607

7900V

Arbeitschse
aus T/C Canvas 260 g/m², mit Einsätzen aus
Oxford, grün

CE

Beta EASY



Größe	I	€	Stück	Artikelnummer
XS	46	65,50	1	079000500
S	48	65,50	1	079000501
M	50	65,50	1	079000502
L	52	65,50	1	079000503
XL	54	65,50	1	079000504
XXL	56	65,50	1	079000505
XXXL	58	65,50	1	079000506
XXXXL	60	65,50	1	079000507

7930MG

Mehrtaschen-Arbeitschse aus 97 % Baumwolle,
3 % Stretch-Gewebe, 220 g/m², grau

CE

Cotton



Größe	I	€	Stück	Artikelnummer
XS	46	67,00	1	079300400
S	48	67,00	1	079300401
M	50	67,00	1	079300402
L	52	67,00	1	079300403
XL	54	67,00	1	079300404
XXL	56	67,00	1	079300405
XXXL	58	67,00	1	079300406

7940

Multischutz-Arbeitschse
aus T/C Twill, 250 g/m², blau
Schutz vor Hitze, Flammen, elektrischem
Lichtbogen, Schweißgefahren und
Chemikalien.

CE



DPI: III^a Categoria
EN ISO 11611:2015 - Classe 1
EN ISO 11612:2015 - A1 B1
C1
EN 1149-5:2018
EN13034:2005+A1:2009
- Type 6
IEC 61482-2:2018 - APC 1

Größe	I	€	Stück	Artikelnummer
XS	46	95,50	1	079400000
S	48	95,50	1	079400001
M	50	95,50	1	079400002
L	52	95,50	1	079400003
XL	54	95,50	1	079400004
XXL	56	95,50	1	079400005
XXXL	58	95,50	1	079400006
XXXXL	60	95,50	1	079400007

BERMUDA



7529

Stretch-Arbeitsjeansshorts aus 98% Baumwolle und 2% Stretch-Gewebe, figurbetonte Passform

CE

Jeans



Größe	I	€	Stück	Artikelnummer
XS	46	54,00	1	075290046
S	48	54,00	1	075290048
M	50	54,00	1	075290050
L	52	54,00	1	075290052
XL	54	54,00	1	075290054
XXL	56	54,00	1	075290056
XXXL	58	54,00	1	075290058

7611G

Arbeitsshorts "Work Trekking" LIGHT 90 % Nylon, 10 % Stretchgewebe, 140 g/m², rückseitig verstärkt. Dunkelgrau mit gelben Details Figurbetonte Passform

CE

TREKING LIGHT



Größe	I	€	Stück	Artikelnummer
XS	46	61,50	1	076110000
S	48	61,50	1	076110001
M	50	61,50	1	076110002
L	52	61,50	1	076110003
XL	54	61,50	1	076110004
XXL	56	61,50	1	076110005
XXXL	58	61,50	1	076110006

7661B

Mehrtaschen-Arbeitsshorts, leichte Ausführung, aus Stretch-Gewebe - 86% Nylon - 14% Spandex, 140 g/m², blau Taschen hinten mit Verstärkungen aus Polyester 300D, reißfester Schritt Slim Fit

CE



Größe	I	€	Stück	Artikelnummer
XS	46	78,00	1	076610100
S	48	78,00	1	076610101
M	50	78,00	1	076610102
L	52	78,00	1	076610103
XL	54	78,00	1	076610104
XXL	56	78,00	1	076610105
XXXL	58	78,00	1	076610106

7661G

Multitaschen-Arbeitsshorts, leichte Ausführung, aus Stretch-Gewebe - 86% Nylon - 14% Spandex, 140 g/m², anthrazitgrau Taschen hinten mit Verstärkungen aus Polyester 300D, reißfester Schritt Slim Fit

CE



Größe	I	€	Stück	Artikelnummer
XS	46	78,00	1	076610000
S	48	78,00	1	076610001
M	50	78,00	1	076610002
L	52	78,00	1	076610003
XL	54	78,00	1	076610004
XXL	56	78,00	1	076610005
XXXL	58	78,00	1	076610006



7815CM

Mehrtaschen-Arbeitsshorts aus T/C Canvas, 260 g/m², Camouflage grau, reißfester Schritt und Stretchgewebe am Innenbein und im Lendenbereich für höhere Bewegungsfreiheit

CE



Größe	I	€	Stück	Artikelnummer
XS	46	66,50	1	078150300
S	48	66,50	1	078150301
M	50	66,50	1	078150302
L	52	66,50	1	078150303
XL	54	66,50	1	078150304
XXL	56	66,50	1	078150305
XXXL	58	66,50	1	078150306

7831SN

Stretch-Arbeitsshorts aus T/C Twill, 200 g/m², schwarz Figurbetonte Passform, reißfester Schritt und Stretch-Einsätze an den Taillenseiten

CE



Größe	I	€	Stück	Artikelnummer
XS	46	54,50	1	078310100
S	48	54,50	1	078310101
M	50	54,50	1	078310102
L	52	54,50	1	078310103
XL	54	54,50	1	078310104
XXL	56	54,50	1	078310105
XXXL	58	54,50	1	078310106

7831ST

Dehnbare Arbeitsshorts aus T/C Twill, 250 g/m², grau Figurbetonte Passform, reißfester Schritt und Stretch-Einsätze an den Taillenseiten

CE



Größe	I	€	Stück	Artikelnummer
XS	46	54,50	1	078310000
S	48	54,50	1	078310001
M	50	54,50	1	078310002
L	52	54,50	1	078310003
XL	54	54,50	1	078310004
XXL	56	54,50	1	078310005
XXXL	58	54,50	1	078310006

7861G

Bermudashorts, leichte Ausführung,
aus T/C Twill, 180 g/m², mit Einsätzen aus
Oxford, grau

Neues Design - Bessere Passform

BetaEASY

CE

LIGHT



Größe	I	€	W	L
XS	46	50,00	1	078610800
S	48	50,00	1	078610801
M	50	50,00	1	078610802
L	52	50,00	1	078610803
XL	54	50,00	1	078610804
XXL	56	50,00	1	078610805
XXXL	58	50,00	1	078610806
XXXXL	60	50,00	1	078610807
5XL	62	50,00	1	078610808

7861B

Arbeits-Bermuda-Shorts, leichte Ausführung,
aus T/C Twill, 180 g/m², mit Oxford-Einsätzen,
blau

BetaEASY

CE

LIGHT



Größe	I	€	W	L
XS	46	50,00	1	078610700
S	48	50,00	1	078610701
M	50	50,00	1	078610702
L	52	50,00	1	078610703
XL	54	50,00	1	078610704
XXL	56	50,00	1	078610705
XXXL	58	50,00	1	078610706
XXXXL	60	50,00	1	078610707
5XL	62	50,00	1	078610708

Beta

7901G

Arbeitsshorts
aus T/C Canvas, 260 g/m², mit Einsätzen aus
Oxford, grau

Neues Design - Bessere Passform

BetaEASY

CE



Größe	I	€	W	L
XS	46	53,00	1	079010800
S	48	53,00	1	079010801
M	50	53,00	1	079010802
L	52	53,00	1	079010803
XL	54	53,00	1	079010804
XXL	56	53,00	1	079010805
XXXL	58	53,00	1	079010806
XXXXL	60	53,00	1	079010807

7931MG

Arbeits-Bermuda-Shorts aus 97 % Baumwolle,
3 % Stretch-Gewebe, 220 g/m², grau

CE

Cotton



Größe	I	€	W	L
XS	46	54,00	1	079310400
S	48	54,00	1	079310401
M	50	54,00	1	079310402
L	52	54,00	1	079310403
XL	54	54,00	1	079310404
XXL	56	54,00	1	079310405
XXXL	58	54,00	1	079310406

OVERALLS



7863G

Arbeitslatzhose, leichte Ausführung,
aus T/C Twill, 180 g/m², mit Einsätzen aus
Oxford, grau

Neues Design - Bessere Passform

BetaEASY

CE

LIGHT



Größe	€	W	L
XS	72,50	1	078630800
S	72,50	1	078630801
M	72,50	1	078630802
L	72,50	1	078630803
XL	72,50	1	078630804
XXL	72,50	1	078630805
XXXL	72,50	1	078630806
XXXXL	72,50	1	078630807
5XL	72,50	1	078630808

7903G

Arbeitslatzhose
aus T/C Canvas, 260 g/m², mit Einsätzen aus
Oxford, grau
Neues Design - Bessere Passform

CE

BetaEASY



	€		
XS	82,00	1	079030800
S	82,00	1	079030801
M	82,00	1	079030802
L	82,00	1	079030803
XL	82,00	1	079030804
XXL	82,00	1	079030805
XXXL	82,00	1	079030806
XXXXL	82,00	1	079030807

7903P

Arbeitslatzhose
aus T/C Canvas, 260 g/m², mit Einsätzen aus
Oxford, petrolblau

CE

BetaEASY



	€		
XS	82,00	1	079030600
S	82,00	1	079030601
M	82,00	1	079030602
L	82,00	1	079030603
XL	82,00	1	079030604
XXL	82,00	1	079030605
XXXL	82,00	1	079030606
XXXXL	82,00	1	079030607

7865B

Arbeitsoverall, leichte Ausführung,
aus T/C Twill, 180 g/m², mit Oxford-Einsätzen,
blau

CE

BetaEASY

LIGHT



	€		
XS	95,00	1	078650700
S	95,00	1	078650701
M	95,00	1	078650702
L	95,00	1	078650703
XL	95,00	1	078650704
XXL	95,00	1	078650705
XXXL	95,00	1	078650706
XXXXL	95,00	1	078650707
5XL	95,00	1	078650708

7865G

Arbeitsoverall, leichte Ausführung,
aus T/C Twill, 180 g/m², mit Einsätzen aus
Oxford, grau
Neues Design - Bessere Passform

CE

BetaEASY

LIGHT



	€		
XS	95,00	1	078650800
S	95,00	1	078650801
M	95,00	1	078650802
L	95,00	1	078650803
XL	95,00	1	078650804
XXL	95,00	1	078650805

	€		
XXXL	95,00	1	078650806
XXXXL	95,00	1	078650807
5XL	95,00	1	078650808

7905G

Arbeitsoverall
aus T/C Canvas, 260 g/m², mit Einsätzen aus
Oxford, grau
Neues Design - Bessere Passform

CE

BetaEASY



	€		
XS	102,50	1	079050800
S	102,50	1	079050801
M	102,50	1	079050802
L	102,50	1	079050803
XL	102,50	1	079050804
XXL	102,50	1	079050805
XXXL	102,50	1	079050806
XXXXL	102,50	1	079050807

7935MG

Arbeitsoverall, 97 % Baumwolle und 3 %
Stretch-Gewebe, 220 g/m², grau

CE

Cotton



	€		
XS	117,00	1	079350400
S	117,00	1	079350401
M	117,00	1	079350402
L	117,00	1	079350403
XL	117,00	1	079350404
XXL	117,00	1	079350405
XXXL	117,00	1	079350406

WORK JACKETS



7653G

Mehrtaschen-Arbeitsjacke aus Stretchgewebe
90% Nylon -10% Spandex, 260g/m²,
Anthrazitgrau



Größe	€	Art-Nr.
XS	105,50	1 076530000
S	105,50	1 076530001
M	105,50	1 076530002
L	105,50	1 076530003
XL	105,50	1 076530004
XXL	105,50	1 076530005
XXXL	105,50	1 076530006

7849BL

Arbeitsjacke aus T/C Twill, 245 g/m², blau,
elastisches Band auf Taillenhöhe



Größe	€	Art-Nr.
XS	49,00	1 078490100
S	49,00	1 078490101
M	49,00	1 078490102
L	49,00	1 078490103
XL	49,00	1 078490104
XXL	49,00	1 078490105
XXXL	49,00	1 078490106
XXXXL	49,00	1 078490107

7869G

Arbeitsjacke, leichte Ausführung,
aus T/C Twill, 180 g/m², mit Einsätzen aus
Oxford, grau
Neues Design - Bessere Passform



Größe	€	Art-Nr.
XS	64,00	1 078690800
S	64,00	1 078690801
M	64,00	1 078690802
L	64,00	1 078690803
XL	64,00	1 078690804
XXL	64,00	1 078690805
XXXL	64,00	1 078690806
XXXXL	64,00	1 078690807
5XL	64,00	1 078690808

7909B

Arbeitsjacke
aus T/C Canvas, 260 g/m², mit Einsätzen aus
Oxford, blau



Größe	€	Art-Nr.
XS	72,50	1 079090700
S	72,50	1 079090701
M	72,50	1 079090702
L	72,50	1 079090703
XL	72,50	1 079090704
XXL	72,50	1 079090705
XXXL	72,50	1 079090706
XXXXL	72,50	1 079090707



7909G

Arbeitsjacke
aus T/C Canvas, 260 g/m², mit Einsätzen aus
Oxford, grau
Neues Design - Bessere Passform



Größe	€	Art-Nr.
XS	72,50	1 079090800
S	72,50	1 079090801
M	72,50	1 079090802
L	72,50	1 079090803
XL	72,50	1 079090804
XXL	72,50	1 079090805
XXXL	72,50	1 079090806
XXXXL	72,50	1 079090807

7909P

Arbeitsjacke
aus T/C Canvas, 260 g/m², mit Einsätzen aus
Oxford, petrolblau



Größe	€	Art-Nr.
XS	72,50	1 079090600
S	72,50	1 079090601
M	72,50	1 079090602
L	72,50	1 079090603
XL	72,50	1 079090604
XXL	72,50	1 079090605
XXXL	72,50	1 079090606
XXXXL	72,50	1 079090607

7909V

Arbeitsjacke
aus T/C Canvas, 260 g/m², mit Einsätzen aus
Oxford, grün



Größe	€	Art-Nr.
XS	72,50	1 079090500
S	72,50	1 079090501
M	72,50	1 079090502
L	72,50	1 079090503
XL	72,50	1 079090504
XXL	72,50	1 079090505
XXXL	72,50	1 079090506
XXXXL	72,50	1 079090507

7949

Multischutz-Arbeitsjacke aus T/C Twill, 250 g/m², blau
Schutz vor Hitze, Flammen, elektrischem Lichtbogen, Schweißgefahren und Chemikalien.

CE

DPI: III^A Categoria
EN ISO 11611:2015 - Classe 1
EN ISO 11612:2015 - A1 B1 C1
EN 1149-5:2018
EN13034:2005+A1:2009 - Type 6
IEC 61482-2:2018 - APC 1



Größe	€	Hand	Computer
XS	110,50	1	079490000
S	110,50	1	079490001
M	110,50	1	079490002
L	110,50	1	079490003
XL	110,50	1	079490004
XXL	110,50	1	079490005
XXXL	110,50	1	079490006
XXXXL	110,50	1	079490007

SLEEVELESS JACKETS



7575N

Softshell-Westе aus 90% Nylon, 10% Stretch-Gewebe, 250 g/m²



Größe	€	Hand	Computer
S	96,50	1	075750301
M	96,50	1	075750302
L	96,50	1	075750303
XL	96,50	1	075750304
XXL	96,50	1	075750305
XXXL	96,50	1	075750306

7579QN

Mehrtaschen-Arbeitsweste aus zwei Materialien.
100% wasserdichter Nylon 300D und Softshell-Gewebe 96% Polyester, 4% Spandex, Wattierung aus Polyester, 160 g/m²
Schwarz/Anthrazitgrau

CE



Größe	€	Hand	Computer
S	83,00	1	075790201
M	83,00	1	075790202
L	83,00	1	075790203
XL	83,00	1	075790204
XXL	83,00	1	075790205
XXXL	83,00	1	075790206

7673NG

Arbeitsweste mit GRAPHENE-Futter 80 g/m², Frontbereich verstärkt in Softshell-Gewebe, 96% Polyester, 4% Spandex, Rückenteil aus 100% Nylon 20D anthrazitgrau (Frontbereich), schwarz (Rückenteil)
Stretch-Einsatz am Ärmelloch
Antistatisch, antibakteriell, winddicht

CE



Größe	€	Hand	Computer
S	106,50	1	076730001
M	106,50	1	076730002
L	106,50	1	076730003
XL	106,50	1	076730004
XXL	106,50	1	076730005
XXXL	106,50	1	076730006

Beta

7867B

Arbeitsweste, leichte Ausführung, aus T/C Twill, 180 g/m², mit Oxford-Einsätzen, blau

CE

Beta EASY

LIGHT



Größe	€	Hand	Computer
XS	55,00	1	078670700
S	55,00	1	078670701
M	55,00	1	078670702
L	55,00	1	078670703
XL	55,00	1	078670704
XXL	55,00	1	078670705
XXXL	55,00	1	078670706
XXXXL	55,00	1	078670707
5XL	55,00	1	078670708

7867G

Arbeitsweste, leichte Ausführung, aus T/C Twill, 180 g/m², mit Einsätzen aus Oxford, grau
Neues Design - Bessere Passform

CE

Beta EASY

LIGHT



Größe	€	Hand	Computer
XS	55,00	1	078670800
S	55,00	1	078670801
M	55,00	1	078670802
L	55,00	1	078670803
XL	55,00	1	078670804
XXL	55,00	1	078670805
XXXL	55,00	1	078670806
XXXXL	55,00	1	078670807
5XL	55,00	1	078670808

7907G

Arbeitsweste
aus T/C Canvas, 260 g/m², mit Einsätzen aus
Oxford, grau
Neues Design - Bessere Passform

CE

Beta EASY



Größe	€	Stk	Art-Nr.
XS	61,00	1	079070800
S	61,00	1	079070801
M	61,00	1	079070802
L	61,00	1	079070803
XL	61,00	1	079070804
XXL	61,00	1	079070805
XXXL	61,00	1	079070806
XXXXL	61,00	1	079070807

7937MG

Arbeitsweste, 97 % Baumwolle und 3 %
Stretch-Gewebe, 220 g/m², grau

CE

Cotton



Größe	€	Stk	Art-Nr.
XS	63,00	1	079370400
S	63,00	1	079370401
M	63,00	1	079370402
L	63,00	1	079370403
XL	63,00	1	079370404
XXL	63,00	1	079370405
XXXL	63,00	1	079370406

JACKETS



7658CM

Softshell-Jacke, 94% Polyester, 6% Spandex,
290 g/m², Camouflage-Grau
Mit wasserabweisender, winddichter und
atmungsaktiver TPU-Membran
(Beständigkeit Wassersäule 8.000 mm -
Atmungsaktivität 8.000 mvp)

TOP



Größe	€	Stk	Art-Nr.
S	132,50	1	076580101
M	132,50	1	076580102
L	132,50	1	076580103
XL	132,50	1	076580104
XXL	132,50	1	076580105
XXXL	132,50	1	076580106

7659N

Softshell-Jacke, 94% Polyester, 6% Spandex, 290 g/
m², mit abnehmbarer Kapuze und Ärmeln, schwarz
Mit wasserabweisender, winddichter und atmungsaktiver
TPU-Membran (Beständigkeit Wassersäule 8.000 mm
-Atmungsaktivität 8.000 mvp)

TOP



Größe	€	Stk	Art-Nr.
S	170,00	1	076590001
M	170,00	1	076590002
L	170,00	1	076590003
XL	170,00	1	076590004
XXL	170,00	1	076590005
XXXL	170,00	1	076590006

7669N

Mehrtaschen-Arbeitsjacke, leichte Ausführung,
aus Stretch-Gewebe - 86% Nylon, 14%
Spandex, 140 g/m², schwarz
Mit abnehmbaren Ärmeln und Kapuze im
Kragen.
Wasserfest, winddicht

TOP



Größe	€	Stk	Art-Nr.
XS	119,00	1	076690000
S	119,00	1	076690001
M	119,00	1	076690002
L	119,00	1	076690003
XL	119,00	1	076690004
XXL	119,00	1	076690005
XXXL	119,00	1	076690006

7670G

Jacke aus wasserdichtem Polyester Oxford
300D,
mit PU-Beschichtung, anthrazitgrau
Mit abtrennbarer Kapuze und Verstärkungen
an den Ärmeln.
Wasserabweisend, winddicht und
atmungsaktiv (Beständigkeit Wassersäule
2.000 mm - Atmungsaktivität 2.000 mvp)
Futter aus Polyester 210T, Wattierung aus
Polyester, 120 g/m² Körper, 100 g/m² Ärmel

CE

TOP



Größe	€	Stk	Art-Nr.
S	119,00	1	076700001
M	119,00	1	076700002
L	119,00	1	076700003
XL	119,00	1	076700004
XXL	119,00	1	076700005
XXXL	119,00	1	076700006

Beta

Beta



7674NG

Arbeitsdaunenjacke mit GRAPHENE-Futter, 80 g/m², Frontbereich und Vorderarm verstärkt in Softshell-Gewebe, 96% Polyester, 4% Spandex, Rückenteil und Ärmel aus 100% Nylon 20D anthrazitgrau (Frontbereich), schwarz (Rückenteil) Stretch-Manschetten Antistatisch, antibakteriell, winddicht



	€		
S	132,50	1	076740001
M	132,50	1	076740002
L	132,50	1	076740003
XL	132,50	1	076740004
XXL	132,50	1	076740005
XXXL	132,50	1	076740006

7780QN

Bomber-Arbeitsjacke mit mehreren Taschen aus zwei Materialien. 100% wasserdichter Nylon 300D und Softshell-Gewebe 96% Polyester, 4% Spandex, Wattierung aus Polyester 160 g/m² mit fest verbundener Kapuze Schwarz/Anthrazitgrau

CE



	€		
S	141,00	1	077800201
M	141,00	1	077800202
L	141,00	1	077800203
XL	141,00	1	077800204
XXL	141,00	1	077800205
XXXL	141,00	1	077800206

7750N

Bomber-Arbeitsjacke mit mehreren Taschen aus 100 % Polyester, Wattierung 100 % Polyester 120 g/m², schwarz

CE



	€		
XS	89,00	1	077500000
S	89,00	1	077500001
M	89,00	1	077500002
L	89,00	1	077500003
XL	89,00	1	077500004
XXL	89,00	1	077500005
XXXL	89,00	1	077500006



7636N

Microfleece-Pullover mit kurzem Reißverschluss, 180 g/m², schwarz mit Reflexeinsätzen



	€		
XS	29,00	1	076360500
S	29,00	1	076360501
M	29,00	1	076360502
L	29,00	1	076360503
XL	29,00	1	076360504
XXL	29,00	1	076360505
XXXL	29,00	1	076360506

7637G

Sweatshirt aus technischem Fleece mit langem Reißverschluss, 250 g/m², mit Kapuze Fleece 100% Polyester mit Einsätzen aus Softshell-Gewebe 100D, mit gebundenem Fleece, 270 g/m² Melange grau/Schwarz



	€		
XS	94,00	1	076370000
S	94,00	1	076370001
M	94,00	1	076370002
L	94,00	1	076370003
XL	94,00	1	076370004
XXL	94,00	1	076370005
XXXL	94,00	1	076370006

7642G

Sweatshirt mit Rundhalsausschnitt, 240 g/m², 60 % Baumwolle, 40 % Polyester grau meliert und schwarze Einsätze



	€		
XS	35,50	1	076420000
S	35,50	1	076420001
M	35,50	1	076420002
L	35,50	1	076420003
XL	35,50	1	076420004
XXL	35,50	1	076420005
XXXL	35,50	1	076420006

7654B

Microfleece-Pullover mit kurzem Reißverschluss, elastisch, 180 g/m², blau 95% Polyester, 5% Spandex



	€		
XS	50,50	1	076540100
S	50,50	1	076540101
M	50,50	1	076540102
L	50,50	1	076540103
XL	50,50	1	076540104
XXL	50,50	1	076540105
XXXL	50,50	1	076540106

7654N

Microfleece-Pullover mit kurzem Reißverschluss, elastisch, 180 g/m², schwarz, 95% Polyester, 5% Spandex



Größe	€	Stk	Art-Nr.
XS	50,50	1	076540000
S	50,50	1	076540001
M	50,50	1	076540002
L	50,50	1	076540003
XL	50,50	1	076540004
XXL	50,50	1	076540005
XXXL	50,50	1	076540006

7657B

Fleece-Pullover mit langem Reißverschluss, elastisch, 280 g/m², blau, 95% Polyester, 5% Spandex



Größe	€	Stk	Art-Nr.
XS	64,00	1	076570100
S	64,00	1	076570101
M	64,00	1	076570102
L	64,00	1	076570103
XL	64,00	1	076570104
XXL	64,00	1	076570105
XXXL	64,00	1	076570106

7657N

Fleece-Pullover mit langem Reißverschluss, elastisch, 280 g/m², schwarz, 95% Polyester, 5% Spandex



Größe	€	Stk	Art-Nr.
XS	64,00	1	076570000
S	64,00	1	076570001
M	64,00	1	076570002
L	64,00	1	076570003
XL	64,00	1	076570004
XXL	64,00	1	076570005
XXXL	64,00	1	076570006

7664G

Sweatshirt mit langem Reißverschluss, 280 g/m², grau, 60% Baumwolle, 40% Polyester



Größe	€	Stk	Art-Nr.
XS	58,50	1	076640100
S	58,50	1	076640101
M	58,50	1	076640102
L	58,50	1	076640103
XL	58,50	1	076640104
XXL	58,50	1	076640105
XXXL	58,50	1	076640106

7664N

Sweatshirt mit langem Reißverschluss, 280 g/m², schwarz, 60% Baumwolle, 40% Polyester



Größe	€	Stk	Art-Nr.
XS	58,50	1	076640000
S	58,50	1	076640001
M	58,50	1	076640002
L	58,50	1	076640003
XL	58,50	1	076640004
XXL	58,50	1	076640005
XXXL	58,50	1	076640006

7665G

Sweatshirt mit langem Reißverschluss und Kapuze, 280 g/m², grau, 60% Baumwolle, 40% Polyester



Größe	€	Stk	Art-Nr.
XS	63,00	1	076650100
S	63,00	1	076650101
M	63,00	1	076650102
L	63,00	1	076650103
XL	63,00	1	076650104
XXL	63,00	1	076650105
XXXL	63,00	1	076650106

7665N

Sweatshirt mit langem Reißverschluss und Kapuze, 280 g/m², schwarz, 60% Baumwolle, 40% Polyester



Größe	€	Stk	Art-Nr.
XS	63,00	1	076650000
S	63,00	1	076650001
M	63,00	1	076650002
L	63,00	1	076650003
XL	63,00	1	076650004
XXL	63,00	1	076650005
XXXL	63,00	1	076650006

SHIRT & T-SHIRT

7545F

Kariertes Arbeitshemd aus Flanell, 100 % Baumwolle, 190 g/m²



Größe	€	Stk	Art-Nr.
XS	44,50	1	075450200
S	44,50	1	075450201
M	44,50	1	075450202
L	44,50	1	075450203
XL	44,50	1	075450204
XXL	44,50	1	075450205
XXXL	44,50	1	075450206

7547AZ

Poloshirt, 3 Knöpfe, aus 100% Baumwolle, 200 g/m², hellblau



Größe	€	Stk	Art-Nr.
XS	33,00	2	075470500
S	33,00	2	075470501
M	33,00	2	075470502
L	33,00	2	075470503
XL	33,00	2	075470504
XXL	33,00	2	075470505
XXXL	33,00	2	075470506

7547BL

Polo-Shirt mit 3 Knöpfen,
aus 100% Baumwolle, 200 g/m², blau



	€		
XS	33,00	2	075470200
S	33,00	2	075470201
M	33,00	2	075470202
L	33,00	2	075470203
XL	33,00	2	075470204
XXL	33,00	2	075470205
XXXL	33,00	2	075470206

7547G

Polo-Shirt mit 3 Knöpfen,
aus 100% Baumwolle, 200 g/m², grau



	€		
XS	33,00	2	075470300
S	33,00	2	075470301
M	33,00	2	075470302
L	33,00	2	075470303
XL	33,00	2	075470304
XXL	33,00	2	075470305
XXXL	33,00	2	075470306

7547N

Polo-Shirt mit 3 Knöpfen
aus 100% Baumwolle, 150 g/m², schwarz



	€		
XS	33,00	2	075470400
S	33,00	2	075470401
M	33,00	2	075470402
L	33,00	2	075470403
XL	33,00	2	075470404
XXL	33,00	2	075470405
XXXL	33,00	2	075470406

7547R

Polo-Shirt mit 3 Knöpfen,
aus 100% Baumwolle, 200 g/m², rot



	€		
XS	33,00	2	075470600
S	33,00	2	075470601
M	33,00	2	075470602
L	33,00	2	075470603
XL	33,00	2	075470604
XXL	33,00	2	075470605
XXXL	33,00	2	075470606

7548M

T-Shirt mit modernem Aufdruck, 100 %
Baumwolle, 150 g/m²



	€		
XS	29,00	1	075480400
XL	29,00	1	075480404
S	29,00	1	075480401
M	29,00	1	075480402
L	29,00	1	075480403
XXL	29,00	1	075480405
XXXL	29,00	1	075480406

7548C

T-Shirt mit klassischem Aufdruck, 100 %
Baumwolle, 150 g/m²



	€		
XS	29,00	1	075480500
S	29,00	1	075480501
M	29,00	1	075480502
L	29,00	1	075480503
XL	29,00	1	075480504
XXL	29,00	1	075480505
XXXL	29,00	1	075480506

7549AZ

Work-T-Shirt aus 100% Baumwolle, 150 g/m²,
hellblau



	€		
XS	21,30	5	075490500
S	21,30	5	075490501
M	21,30	5	075490502
L	21,30	5	075490503
XL	21,30	5	075490504
XXL	21,30	5	075490505
XXXL	21,30	5	075490506

7549BL

Work-T-Shirt aus 100% Baumwolle, 150 g/m²,
blau



	€		
XS	21,30	5	075490200
S	21,30	5	075490201
M	21,30	5	075490202
L	21,30	5	075490203
XL	21,30	5	075490204
XXL	21,30	5	075490205
XXXL	21,30	5	075490206

7549G

Work-T-Shirt aus 100% Baumwolle, 150 g/m²,
grau



	€		
XS	21,30	5	075490300
S	21,30	5	075490301
M	21,30	5	075490302
L	21,30	5	075490303
XL	21,30	5	075490304
XXL	21,30	5	075490305
XXXL	21,30	5	075490306

7549NE

Work-T-Shirt aus 100% Baumwolle, 150 g/m², schwarz



Größe	€	Stk	Art-Nr.
XS	21,30	5	075490700
S	21,30	5	075490701
M	21,30	5	075490702
L	21,30	5	075490703
XL	21,30	5	075490704
XXL	21,30	5	075490705
XXXL	21,30	5	075490706

7549N

Work-T-Shirt aus 100% Baumwolle, 150 g/m², schwarz



Größe	€	Stk	Art-Nr.
XS	21,30	5	075490400
S	21,30	5	075490401
M	21,30	5	075490402
L	21,30	5	075490403
XL	21,30	5	075490404
XXL	21,30	5	075490405
XXXL	21,30	5	075490406

7549R

Work-T-Shirt aus 100% Baumwolle, 150 g/m², rot



Größe	€	Stk	Art-Nr.
XS	21,30	5	075490600
S	21,30	5	075490601
M	21,30	5	075490602
L	21,30	5	075490603
XL	21,30	5	075490604
XXL	21,30	5	075490605
XXXL	21,30	5	075490606

7550G

Technisches Arbeits-T-Shirt aus Polyester, 120 g/m², mit 37.5°-Technologie, grau mit schwarzen, orangefarbenen und reflektierenden Details



Größe	€	Stk	Art-Nr.
XS	45,50	1	075500400
S	45,50	1	075500401
M	45,50	1	075500402
L	45,50	1	075500403
XL	45,50	1	075500404
XXL	45,50	1	075500405
XXXL	45,50	1	075500406

7550N

Technisches Arbeits-T-Shirt aus Polyester, 120 g/m², mit 37.5°-Technologie, schwarz mit grauen, orangefarbenen und reflektierenden Details



Größe	€	Stk	Art-Nr.
XS	45,50	1	075500500
S	45,50	1	075500501
M	45,50	1	075500502
L	45,50	1	075500503
XL	45,50	1	075500504
XXL	45,50	1	075500505
XXXL	45,50	1	075500506

7557BL

Langarm-Poloshirt, 3 Knöpfe, aus 100% Baumwolle, 200 g/m², blau



Größe	€	Stk	Art-Nr.
XS	38,50	1	075570200
S	38,50	1	075570201
M	38,50	1	075570202
L	38,50	1	075570203
XL	38,50	1	075570204
XXL	38,50	1	075570205
XXXL	38,50	1	075570206

RAIN

7970

Hose aus PVC Trikot, wasserdicht, blau
NUR NOCH SOLANGE DER VORRAT REICHT

CE



EN 343

Größe	€	Stk	Art-Nr.
XS	49,00	1	079700000
S	49,00	1	079700001
M	49,00	1	079700002
L	49,00	1	079700003
XL	49,00	1	079700004
XXL	49,00	1	079700005
XXXL	49,00	1	079700006



7971L

Wasserdichte Hose aus PVC-beschichtetem Polyester mit durch Thermoklebeband geschützten Nähten, blau
Mit Gummi im Taillenumfang und mit über Druckknöpfe regulierbarem Beinabschluss

CE



EN 343

	€		
XS	27,50	1	079710100
S	27,50	1	079710101
M	27,50	1	079710102
L	27,50	1	079710103
XL	27,50	1	079710104
XXL	27,50	1	079710105
XXXL	27,50	1	079710106

7978L

Regenmantel aus PVC-beschichtetem Polyester mit nicht abnehmbarer Kapuze und durch Thermoklebeband geschützte Nähten, blau
Mit Druckknöpfen, die ein Verkürzen des Mantels auf 3/4 ermöglichen

CE



EN 343

	€		
XS	38,00	1	079780100
S	38,00	1	079780101
M	38,00	1	079780102
L	38,00	1	079780103
XL	38,00	1	079780104
XXL	38,00	1	079780105
XXXL	38,00	1	079780106

7979

Jacke aus PVC Trikot, wasserdicht, blau
NUR NOCH SOLANGE DER VORRAT REICHT

CE



EN 343

	€		
S	80,50	1	079790001
M	80,50	1	079790002
L	80,50	1	079790003
XL	80,50	1	079790004
XXL	80,50	1	079790005
XXXL	80,50	1	079790006

UNDERWEAR

7996N

Techno-Unterwäsche Set, Techno-Langarmunterhemd + Techno-Leggings, 92% Polyester, 8% Spandex, 160 g/m², schwarz



	€		
XS-S	46,00	1	079960000
M-L	46,00	1	079960002
XL-XXL	46,00	1	079960004



ACCESSORIES

7800G

Knieschützer (Paar) für Arbeitskleidung



7800G € 16,50 1 078000500

7980L

Wintermütze mit wiederaufladbarem LED-Licht und Umschlag,

100 % Acryl

LED-Licht mit 3 Leuchtstärken, bis zu 60

Lumen,

Einheitsgröße,

schwarz

- Über USB-Anschluss wiederaufladbar
- Leuchtstärke: bis zu 60 Lumen
- Akkulatedauer: 80 Minuten
- Akkulaufzeit: 85 ÷ 290 Minuten



7980L € 15,80 10 079800200

7980NC

Fleece-Wintermütze, 100% Polyester, doppelseitig verwendbar (Double-face), Camouflage/Schwarz

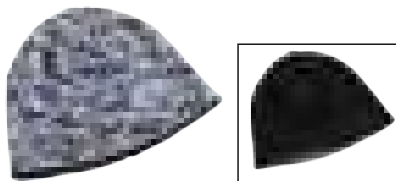

7980NC € 14,50 10 079800112

7980RN

Wintermütze mit Umschlag aus 100 %

Acrylgewebe

Mit 3M Thinsulate™-Futter,

Einheitsgröße,

schwarz



7980RN € 13,50 10 079800120

7981N

Regenkappe

100 % PU-beschichtetes Nylon mit wasserabweisender Behandlung



L = Ø 58 cm € 23,60 1 079810158
XL = Ø 60 cm € 23,60 1 079810160

7982N

Schwarze Kappe mit gewölbtem Schild, 100 % Polyester, Riemenverschluss



7982N € 12,00 10 079820000

7984EG

Arbeitsgürtel aus Stretch-Gewebe, mit Hakenschnalle aus satiniertem Zinkmetall, Einheitsgröße 120 cm, verkürzbar, Breite 37 mm, grau



7984EG € 28,00 1 079840520

7984G

Arbeitsgürtel aus 100% TPE mit Schnalle aus chromiertem Zinkmetall

Einheitsgröße 125 cm verkürzbar, Breite 35 mm, schwarz



7984G € 19,30 1 079840525

7985N

Halswärmer aus Mikrofleece mit Kordelzug, auch als Mütze verwendbar schwarz mit grauen und Reflex-Details



7985N € 13,50 10 079850000



7104 90

Kunststoffsäulen mit auffüllbarem Sockel



7104 90 H mm 90 € 30,00 4 071040004

7105 6

Abgrenzungskette aus Kunststoff



7105 6 Ø mm 6 L m 25 € 72,50 1 071050006

7109A

Warnschilder aus Aluminium



	H mm	€		
7109A 1	140	12,70	1	071090001
7109A 2	140	12,70	1	071090002
7109A 3	140	12,70	1	071090003
7109A 4	140	12,70	1	071090004

7109D

Verbotsschilder



	H mm	€		
7109D 1	115	12,70	1	071090051
7109D 2	115	12,70	1	071090052
7109D 3	115	12,70	1	071090053



7061TC

Schutzbrille mit transparenten Polycarbonat-Gläsern

CE



EN166:2001
EN170
2C-1.2 1F

7061TC € 10,70 1 070610001

7076BC

Schutzbrille mit transparenten Polycarbonat-Gläsern

CE



EN166:2001
EN172
5-1.7 1F

7076BC € 24,30 1 070760009

7076BD

Schutzbrille mit transparenten Polycarbonat-Gläsern

CE



EN166:2001
EN172
5-3.1 1F

7076BD € 24,30 1 070760019

7076BP

Schutzbrille mit polarisierten Polycarbonat-Gläsern

CE



EN ISO 12312-1:2013+A1:2015
EN 1836
3P

7076BP € 38,50 1 070760029

7076BU

Schutzbrille mit orangefarbenen Polycarbonat-Gläsern

CE



EN ISO 12311:2013
UV 500

7076BU € 19,90 1 070760039

7093BC

Schutzbrille mit transparenten Polycarbonat-Gläsern

CE



EN166:2001
EN170
2C-1.2 1F

7093BC € 36,50 1 070930009

7093BD

Schutzbrille mit dunklen Polycarbonat-Gläsern

CE



EN166:2001
EN172
5-3.1 1F

7093BD € 36,50 1 070930019



C62M/WW

Schaufensterpuppe, realistische Größe, Metallfuß



185 cm

C62M/WW € 281,00 1 062000362

C64

Ausstellungswand Bekleidung und Schuhe, leer



2400 mm

L	€	1	064000021
1 m	1.565,00	1	064000021
2 m	2.860,00	1	064000022
3 m	4.120,00	1	064000023
4 m	5.390,00	1	064000024

C64G

Ausstellungsgondel Bekleidung und Schuhe,
leer

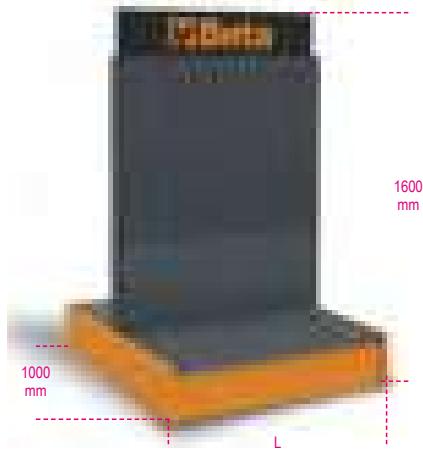

L	€	Icon	Icon
1 m	1.960,00	1	064000051
2 m	3.560,00	1	064000052

C64CW

Kabine



C64CW	€	Icon	Icon
	668,00	1	064000610

6200AP/S10

Kleiderbügelsatz, 10teilig



6200AP/S10	€	Icon	Icon
	48,00	1	062000331

6800BA

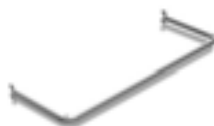

6800BA	€	Icon	Icon
	141,00	1	068000130

6800RS



6800RS	€	Icon	Icon
	121,00	1	068000135

6888GS

Schuhhaken für Aussteller Art. C64



6888GS	€	Icon	Icon
	30,00	2	068880122

170x120 mm

6888GW

Haken für Aussteller Art. C64



6888GW	€	Icon	Icon
	8,50	2	068880121

400 mm

9562TB

Schuhanprobe-Teppich, mit Rückseite aus
rutschfestem Gummi



9562TB	L mm	H mm	€	Icon	Icon
	800	600	54,50	1	095620500

9565S

Stahlblechtonne mit Sitz aus abziehbarem
Ökoleder



9565S	H cm	ø cm	€	Icon	Icon
	60	38	240,50	1	095650300





Robur

Seit 1930 stellt Robur als Zweigbetrieb von BetaUtensili Seilzubehör mit der bewährten Qualität her.

Erfahrung, Organisation und Technologie sind die Voraussetzungen für eine stetige Weiterentwicklung auf der Grundlage der Marktbedürfnisse.

Seit 1984 befindet sich der Sitz von Robur in einem modernen Werk in Sulmona.

 **Sonderverpackungen für den freien Service**

BELASTUNG

WLL: Maximale Betriebsbelastung (bei Hebevorrichtungen)

WFL: Arbeits-Grenzkraft (für nicht für den Hub bestimmtes Zubehör)

BF: Max. Kraft beim Artikel während der statischen Zugkraftprüfung

LC: Ankerspannung

Neue Artikel 2024

8134

Permanent-Lasthebemagnete

CE



EN13155

Technische Daten:
 • Sicherheitskoeffizient: 3
 • Serienidentifikationsplatte

Verfügbare Zertifikationen:
 • Herstellerzertifikat
 • Konformitätserklärung DM2006/42/EG
 • Abnahmeprüfzeugnis Typ 2.2 UNI EN10204
 • Bedienungs- und Wartungsanleitung

Maß	WLL kg	A mm	B mm	C mm	€	Preis	Nummer
Standard-Packung	100	70	64	92	510,00	1	081340010
	300	96	88	165	896,00	1	081340030
	600	120	118	230	1.665,00	1	081340060
	1000	168	168	264	2.750,00	1	081340100

8105
Spannschlösser mit zwei Osen,
hochwiderstandsfähig - feuerverzinkt

CE

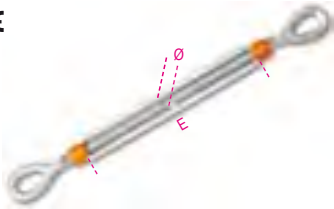

TECHNISCHE DATEN

- Mindest-Sicherheitskoeffizient: 5
- Wärmebehandlung der Spannschlossmutter: Normalglühen
- Wärmebehandlung der Osen: Vergütung

LABORANALYSEN

- chemische Analyse

- Zerreißprobe

VERFÜGBARE ZERTIFIKATIONEN

- Produktspezifikation
- Abnahmeprüfzeugnis Typ 2.2 UNI EN10204

ØxE "	≈ mm	WLL kg	€	📦	🚚
3/8x6	M10x150	540	16,10	5	081050010
1/2x6	M12x150	1000	26,50	5	081050011
1/2x9	M12x230	1000	34,00	5	081050012
5/8x6	M16x150	1590	41,00	2	081050014
5/8x9	M16x230	1590	50,50	2	081050016
5/8X12	M16X300	1590	60,50	2	081050015
3/4x6	M20x150	2360	65,00	2	081050017
3/4x9	M20x230	2360	75,50	2	081050020
3/4x12	M20x300	2360	90,00	2	081050018
3/4x18	M20x460	2360	118,50	2	081050021
7/8x12	M22x300	3270	127,50	1	081050022
1x6	M24x150	4540	135,00	1	081050024
1x12	M24x300	4540	194,50	1	081050025
1x18	M24X460	4540	228,50	1	081050026
1.1/4x12	M33x300	6900	332,00	1	081050031
1.1/4x18	M33x460	6900	342,00	1	081050032
1.1/4x24	M33x610	6900	463,00	1	081050033
1.1/2x12	M39x300	9710	410,00	1	081050034
1.1/2x18	M39x460	9710	498,00	1	081050035
1.3/4x18	M45x460	12700	754,00	1	081050036

Sonderverpackungen für den freien Service



ØxE "	📦	€	📦	🚚
3/8x6	1	17,60	1	081059010
1/2x9	1	36,00	1	081059012



8109
Spannschlösser mit zwei Gabeln,
hochwiderstandsfähig - feuerverzinkt

CE

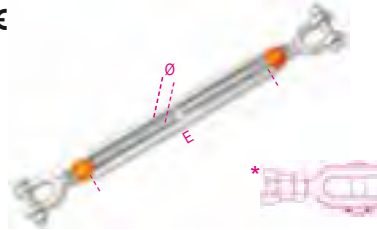

TECHNISCHE DATEN

- Mindest-Sicherheitskoeffizient: 5
- Wärmebehandlung der Spannschlossmutter: Normalglühen
- Wärmebehandlung der Gabel: Vergütung

LABORANALYSEN

- chemische Analyse

- Zerreißprobe

VERFÜGBARE ZERTIFIKATIONEN

- Produktspezifikation
- Abnahmeprüfzeugnis Typ 2.2 UNI EN10204

ØxE "	≈ mm	WLL kg	€	📦	🚚
3/8x6	M10x150	540	20,90	5	081090010
1/2x6	M12x150	1000	34,50	5	081090011
1/2x9	M12x230	1000	41,50	5	081090012
1/2x12	M12x300	1000	52,50	5	081090013
5/8x6	M16x150	1590	63,00	2	081090015
5/8x9	M16x230	1590	75,00	2	081090016
5/8X12	M16X300	1590	84,00	2	081090017
3/4x6	M20x150	2360	88,50	2	081090018
3/4x9	M20x230	2360	102,00	2	081090020
3/4x12	M20x300	2360	114,00	2	081090019
3/4x18	M20x460	2360	136,00	2	081090021
7/8x12	M22x300	3270	171,00	1	081090022
7/8x18	M22x460	3270	206,50	1	081090023
1x6	M24x150	4540	169,00	1	081090024
1x12	M24x300	4540	243,00	1	081090025
1x18	M24x460	4540	280,00	1	081090026
* 1.1/4x12	M33x300	6900	394,00	1	081090031
* 1.1/4x18	M33x460	6900	442,00	1	081090032
* 1.1/4x24	M33x610	6900	613,00	1	081090033
* 1.1/2X12	M39x300	9710	572,00	1	081090034
* 1.1/2x18	M39x460	9710	654,00	1	081090038
* 1.1/2x24	M39x610	9710	784,00	1	081090039
* 1.3/4X18	M45x460	12700	954,00	1	081090036

Sonderverpackungen für den freien Service



ØxE "	📦	€	📦	🚚
3/8x6	1	22,40	1	081099010
1/2x9	1	42,50	1	081099012

8110
Spannschlösser mit Ose und Gabel, hochfest,
heißverzinkt

CE

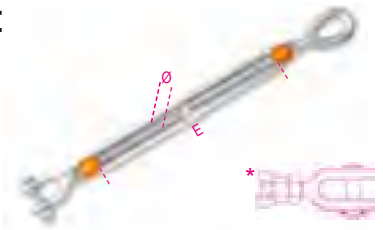

TECHNISCHE DATEN

- Mindest-Sicherheitskoeffizient: 5
- Wärmebehandlung der Spannschlossmutter: Normalglühen
- Wärmebehandlung der Gabel: Vergütung

LABORANALYSEN

- chemische Analyse

- Zerreißprobe

VERFÜGBARE ZERTIFIKATIONEN

- Produktspezifikation
- Abnahmeprüfzeugnis Typ 2.2 UNI EN10204
- Prüfbescheinigung Typ 3.1 UNI EN10204
- CE-Konformitätserklärung

ØxE "	≈ mm	WLL kg	€	📦	🚚
3/8x6	M10X150	540	19,00	5	081100004
1/2x6	M12x150	1000	30,50	5	081100006
1/2x9	M12x230	1000	37,50	5	081100010
5/8x6	M16x150	1590	52,50	2	081100014
5/8x9	M16X230	1590	61,50	2	081100015
5/8x12	M16x300	1590	71,50	2	081100016
3/4x6	M20x150	2360	77,50	2	081100019
3/4x9	M20x230	2360	89,50	2	081100020
3/4x12	M20x300	2360	101,50	2	081100021
7/8X12	M22x300	3270	148,50	1	081100022
1x6	M24x150	4540	152,50	1	081100027
1x12	M24x300	4540	218,50	1	081100029
*1.1/4x12	M33x300	6900	364,00	1	081100034
*1.1/4x18	M33X460	6900	432,00	1	081100035
*1.1/4x24	M33X610	6900	537,00	1	081100036
*1.1/2x12	M39x300	9710	510,00	1	081100038
*1.1/2x18	M39x460	9710	578,00	1	081100039
*1.3/4x18	M45x460	12700	882,00	1	081100044

* Gabel mit durchgehendem Bolzen und Splint



SPANNSCHLÖSSER



Das originelle Design der historischen Spannschlösser Robur wird von italienischen Konstrukteuren und Bauingenieuren besonders geschätzt, da sie präzise Maßtoleranzen aufweisen, höhere Festigkeitswerte als die Modelle nach DIN 1480 haben und die Rückverfolgbarkeit durch den Hersteller und den Identifikationscode auf der Mutter gewährleistet ist. Die hochwertige elektrolytische Verzinkung mit gleichmäßiger Ablagerung und ohne sechswertiges Chrom sorgt für Witterungsbeständigkeit und ein sauberes Erscheinungsbild bei sichtbaren baulichen Einbauten



8005Z

Spannschlösser mit zwei Ösen, verzinkt

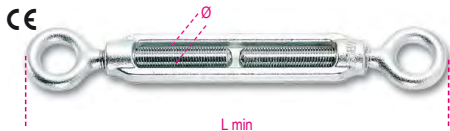

TECHNISCHE DATEN

• Mindest-Sicherheitskoeffizient: 4

LABORANALYSEN

• chemische Analyse
• Zerreißprobe

VERFÜGBARE ZERTIFIKATIONEN

• Produktspezifikation
• Abnahmeprüfzeugnis Typ 2.2 UNI EN10204
* CE-Konformitätserklärung

Ø mm	≈	L min mm	WFL kg	€	📦	🚚
M5	3/16	118	115	2,70	400	080050105
M6	1/4	130	160	3,10	300	080050106
M8	5/16	158	300	4,60	200	080050108
M10	3/8	192	470	6,70	100	080050110
M11	7/16	206	580	8,60	80	080050111
M12	1/2	226	690	10,10	60	080050112
M14	9/16	256	940	13,70	15	080050114
M16	5/8	290	1290	20,70	10	080050116
M18	11/16	358	1660	31,50	1	080050118
M20	3/4	358	2130	34,50	1	080050120
M22	7/8	400	2630	47,00	1	080050122
M24	1"	436	3060	59,00	1	080050124
M27	1 1/8	474	4000	85,50	1	080050125
M30	1 3/16	498	4860	104,00	1	080050130
M33	1 1/4	516	6040	121,00	1	080050126
M36	1 3/8	532	6500	149,50	1	080050136
M39	1 1/2	544	7900	176,00	1	080050139

Spezial-Verpackung



Ø mm	≈	📦	€	📦	🚚
M5	3/16	30	91,00	1	080050705
M6	1/4	30	100,00	1	080050706
M8	5/16	20	101,50	1	080050708
M10	3/8	15	110,00	1	080050710
M11	7/16	15	143,00	1	080050711
M12	1/2	15	169,00	1	080050712

Sonderverpackungen für den freien Service

Ø mm	📦	€	📦	🚚
M5	2	6,40	1	080059305
M6	2	7,30	1	080059306
M8	1	6,10	1	080059108
M10	1	7,90	1	080059110
M11	1	10,30	1	080059111
M12	1	11,50	1	080059112
M14	1	14,80	1	080059114
M16	1	22,10	1	080059116

8005TZ

Rohrspannschlösser mit zwei Ösen, verzinkt



TECHNISCHE DATEN

• Mindest-Sicherheitskoeffizient: 4

LABORANALYSEN

• chemische Analyse
• Zerreißprobe

VERFÜGBARE ZERTIFIKATIONEN

• Produktspezifikation
• Abnahmeprüfzeugnis Typ 2.2 UNI EN10204
• CE-Konformitätserklärung

Ø mm	≈	WFL kg	€	📦	🚚
M12	1/2	690	13,60	15	080050512
M16	5/8	1290	23,30	1	080050516
M20	3/4	2130	33,50	1	080050520
M24	1"	3060	61,00	1	080050524
M27	1 1/8	4000	83,00	1	080050527
M30	1 3/16	4860	95,50	1	080050530
M36	1 3/8	6500	153,50	1	080050536

Sonderverpackungen für den freien Service

Ø mm	📦	€	📦	🚚
M12	1	16,10	1	080059512



Robur

8006Z

Spannschlösser mit Haken und Öse, verzinkt

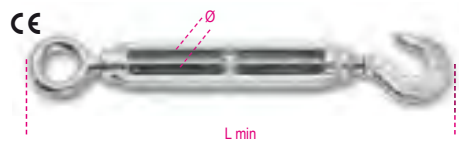

TECHNISCHE DATEN

• Mindest-Sicherheitskoeffizient: 4

LABORANALYSEN

• chemische Analyse
• Zerreißprobe

VERFÜGBARE ZERTIFIKATIONEN

• Produktspezifikation
• Abnahmeprüfzeugnis Typ 2.2 UNI EN10204
* CE-Konformitätserklärung

Ø mm	≈	L min mm	WFL kg	€	📦	🚚
M5	3/16	121	25	3,00	400	080060105
M6	1/4	132	45	3,20	250	080060106
M8	5/16	170	95	4,80	180	080060108
M10	3/8	204	140	7,10	100	080060110
M11	7/16	221	165	9,30	15	080060111
M12	1/2	244	300	11,00	15	080060112
M14	9/16	284	420	15,70	10	080060114
M16	5/8	322	570	23,20	1	080060116
M18	11/16	373	700	34,00	1	080060118
M20	3/4	391	900	40,50	1	080060120
M22	7/8	433	1100	54,00	1	080060122
M24	1"	470	1300	72,50	1	080060124
M27	1 1/8	503	2300	98,50	1	080060127

Spezial-Verpackung



Ø mm	≈	📦	€	📦	🚚
M5	3/16	30	96,00	1	080060705
M6	1/4	30	105,50	1	080060706
M8	5/16	20	107,00	1	080060708
M10	3/8	15	119,50	1	080060710

Sonderverpackungen für den freien Service

Ø mm	📦	€	📦	🚚
M5	2	7,20	1	080069305
M6	2	8,10	1	080069306
M8	1	6,20	1	080069108
M10	1	8,40	1	080069110
M11	1	10,80	1	080069111
M12	1	12,10	1	080069112
M14	1	17,40	1	080069114

8007Z

Spannschlösser mit zwei Haken, verzinkt

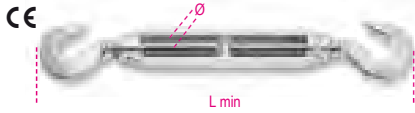

TECHNISCHE DATEN

- Mindest-Sicherheitskoeffizient: 4
- LABORANALYSEN
- chemische Analyse
- Zerreißprobe
- VERFÜGBARE ZERTIFIKATIONEN
- Produktspezifikation
- Abnahmeprüfzeugnis Typ 2.2 UNI EN10204
- CE-Konformitätserklärung

Ø mm	≈	L min mm	WFL kg	€	📦	🚚
M5	3/16	124	25	3,10	30	080070105
M6	1/4	134	45	3,40	30	080070106
M8	5/16	181	95	5,10	20	080070108
M10	3/8	211	140	7,60	15	080070110
M11	7/16	231	165	10,00	15	080070111
M12	1/2	262	300	12,00	15	080070112
M14	9/16	312	420	17,80	1	080070114
M16	5/8	354	570	25,50	1	080070116
M18	11/16	388	700	36,50	1	080070118
M20	3/4	424	900	47,00	1	080070120
M22	7/8	466	1100	60,50	1	080070122
M24	1"	504	1300	85,50	1	080070124
M27	1 1/8	532	2300	111,00	1	080070127

Sonderverpackungen für den freien Service

Ø mm	📦	€	🚚
M5	2	7,70	1
M6	2	8,10	1
M8	1	6,10	1
M10	1	8,20	1
M11	1	11,10	1
M12	1	13,20	1

8008N

Spannschlösser mit zwei Anschweissenden, schwarz

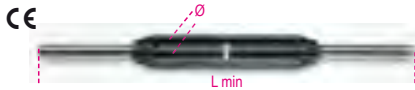

TECHNISCHE DATEN

- Mindest-Sicherheitskoeffizient: 4
- LABORANALYSEN
- chemische Analyse
- Zerreißprobe
- VERFÜGBARE ZERTIFIKATIONEN
- Produktspezifikation
- Abnahmeprüfzeugnis Typ 2.2 UNI EN10204
- CE-Konformitätserklärung

Ø mm	≈	L min mm	WFL kg	€	📦	🚚
M5	3/16	160	115	2,70	30	080080205
M6	1/4	180	160	3,00	30	080080206
M8	5/16	210	300	4,10	20	080080208
M10	3/8	250	470	5,50	15	080080210
M12	1/2	280	690	8,20	15	080080212
M14	9/16	340	940	11,40	5	080080214
M16	5/8	380	1290	15,20	5	080080216
M18	11/16	410	1660	22,60	3	080080218
M20	3/4	440	2130	26,50	3	080080220
M22	7/8	480	2630	34,00	2	080080222
M24	1"	520	3060	44,00	2	080080224
M27	1 1/8	560	4000	68,00	1	080080227
M30	1 1/4	600	4860	85,50	1	080080230
M33	1 1/2	600	6040	91,50	1	080080233
M36	1 3/8	600	6500	119,00	1	080080236
M39	1 1/2	600	7900	135,00	1	080080239

Sonderverpackungen für den freien Service

Ø mm	📦	€	🚚
M5	2	7,30	1
M6	2	7,40	1
M8	1	5,50	1
M10	1	7,20	1
M12	1	9,10	1
M14	1	12,80	1

8008TZN

Spannschlösser mit zwei Anschweißenden Rohrmutter DIN 1478 schwarze Enden, verzinkter Körper



TECHNISCHE DATEN

- Mindest-Sicherheitskoeffizient: 4
- LABORANALYSEN
- chemische Analyse
- Zerreißprobe
- VERFÜGBARE ZERTIFIKATIONEN
- Produktspezifikation
- Abnahmeprüfzeugnis Typ 2.2 UNI EN10204
- CE-Konformitätserklärung

Ø mm	≈	WFL kg	€	📦	🚚
M12	1/2	690	11,20	10	080080512
M16	5/8	1290	18,30	1	080080516
M20	3/4	2130	27,00	1	080080520
M24	1	3060	48,00	1	080080524
M27	1.1/8	4000	69,00	1	080080527
M30	1.3/16	4860	82,50	1	080080530
M36	1.3/8	6500	129,50	1	080080536

8009Z

Spannschlösser mit zwei Gabeln, verzinkt

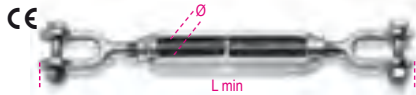

TECHNISCHE DATEN

- Mindest-Sicherheitskoeffizient: 4
- LABORANALYSEN
- chemische Analyse
- Zerreißprobe
- VERFÜGBARE ZERTIFIKATIONEN
- Produktspezifikation
- Abnahmeprüfzeugnis Typ 2.2 UNI EN10204
- CE-Konformitätserklärung

Ø mm	≈	L min mm	WFL kg	€	📦	🚚
M8	5/16	192	300	14,90	15	080090008
M10	3/8	234	470	17,80	15	080090010
M12	1/2	274	690	24,00	15	080090012
M14	9/16	342	940	33,00	1	080090014
M16	5/8	372	1290	38,50	1	080090016
M18	11/16	406	1660	56,50	1	080090018
M20	3/4	406	2130	60,00	1	080090020
M22	7/8	466	2630	83,00	1	080090022
M24	1"	486	3060	96,50	1	080090024
M27	1 1/8	510	4000	151,50	1	080090027
M30	1 3/16	566	4860	194,50	1	080090030

Spezielle Spannschlösser



Ø mm	≈	📦	€	🚚
M8	5/16	5	83,00	1
M10	3/8	5	100,00	1
M12	1/2	5	133,00	1

Sonderverpackungen für den freien Service

Ø mm	📦	€	🚚
M8	1	16,80	1
M10	1	19,20	1
M12	1	26,00	1

8009TZ

Spannschlösser mit zwei Gabeln, Rohrmutter DIN 1478, verzinkt



TECHNISCHE DATEN

- Sicherheitskoeffizient: 4
- LABORANALYSEN
- chemische Analyse
- Zerreißprobe
- VERFÜGBARE ZERTIFIKATIONEN
- Produktspezifikation
- Abnahmeprüfzeugnis Typ 2.2 UNI EN10204
- CE-Konformitätserklärung

Ø mm	≈	WFL kg	€	📦	🚚
M12	1/2	690	26,50	10	080090512
M16	5/8	1290	41,50	1	080090516
M20	3/4	2130	58,50	1	080090520
M24	1	3060	98,50	1	080090524
M27	1.1/8	4000	148,50	1	080090527
M30	1.3/16	4860	187,00	1	080090530

Sonderverpackungen für den freien Service

Ø mm	📦	€	🚚
M12	1	26,50	1

Robur

8010Z

Spannschlösser mit Öse und Gabel, verzinkt

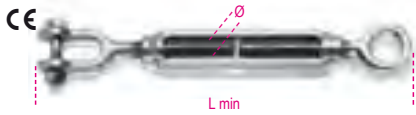

TECHNISCHE DATEN

• Mindest-Sicherheitskoeffizient: 4

LABORANALYSEN

- chemische Analyse
- Zerreißprobe

VERFÜGBARE ZERTIFIKATIONEN

- Produktspezifikation
- Abnahmeprüfzeugnis Typ 2.2 UNI EN10204
- CE-Konformitätserklärung

Ø mm	≈	L min mm	WFL kg	€	📦	📄
M8	5/16	175	300	9,80	20	080100008
M10	3/8	215	470	12,20	15	080100010
M12	1/2	250	690	17,00	10	080100012
M14	9/16	299	940	23,30	10	080100014
M16	5/8	331	1290	30,00	1	080100016
M18	11/16	382	1660	43,00	1	080100018
M20	3/4	382	2130	47,00	1	080100020
M22	7/8	433	2630	65,00	1	080100022
M24	1"	461	3060	77,50	1	080100024
M27	1 1/8	492	4000	118,50	1	080100027
M30	1 3/16	529	4860	149,00	1	080100030

Sonderverpackungen für den freien Service



Ø mm	📦	€	📄
M8	1	10,90	1 080109008
M10	1	13,50	1 080109010
M12	1	18,30	1 080109012
M14	1	26,00	1 080109014

8010TZ

Spannschlösser mit Öse und Gabel Rohrmutter DIN 1478 verzinkt



TECHNISCHE DATEN

• Mindest-Sicherheitskoeffizient: 4

LABORANALYSEN

- chemische Analyse
- Zerreißprobe

VERFÜGBARE ZERTIFIKATIONEN

- Produktspezifikation
- Abnahmeprüfzeugnis Typ 2.2 UNI EN10204
- CE-Konformitätserklärung

Ø mm	≈	WFL kg	€	📦	📄
M12	1/2	690	19,80	10	080100612
M16	5/8	1290	33,00	1	080100616
M20	3/4	2130	46,50	1	080100620
M24	1	3060	79,50	1	080100624
M27	1.1/8	4000	116,00	1	080100627
M30	1.3/16	4860	141,00	1	080100630

8011Z

Spannschlösser mit Haken und Gabel, verzinkt

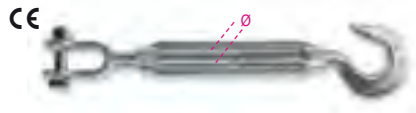

TECHNISCHE DATEN

• Mindest-Sicherheitskoeffizient: 4

LABORANALYSEN

- chemische Analyse
- Zerreißprobe

VERFÜGBARE ZERTIFIKATIONEN

- Produktspezifikation
- Abnahmeprüfzeugnis Typ 2.2 UNI EN10204
- CE-Konformitätserklärung

Ø mm	≈	L min mm	WFL kg	€	📦	📄
M12	1/2	270	300	15,20	1	080110112
M16	5/8	360	570	31,50	1	080110116
M20	3/4	420	900	52,00	1	080110120
M24	1"	490	1300	87,00	1	080110124
M27	1 1/8	500	2300	121,00	1	080110127

8011TZ

Spannschlösser mit Haken und Gabel, Rohrmutter DIN 1478, verzinkt



TECHNISCHE DATEN

• Mindest-Sicherheitskoeffizient: 4

LABORANALYSEN

- chemische Analyse
- Zerreißprobe

VERFÜGBARE ZERTIFIKATIONEN

- Produktspezifikation
- Abnahmeprüfzeugnis Typ 2.2 UNI EN10204
- CE-Konformitätserklärung

Ø mm	≈	L min mm	WFL kg	€	📦	📄
M12	1/2	260	300	17,40	1	080110612
M16	5/8	350	570	32,00	1	080110616
M20	3/4	400	900	48,50	1	080110620
M24	1"	490	1300	84,00	1	080110624
M27	1 1/8	500	2300	111,50	1	080110627

8001Z

Spannschlossmutter, verzinkt



TECHNISCHE DATEN

• Mindest-Sicherheitskoeffizient: 4

LABORANALYSEN

- chemische Analyse
- Zerreißprobe

VERFÜGBARE ZERTIFIKATIONEN

- Produktspezifikation
- Abnahmeprüfzeugnis Typ 2.2 UNI EN10204
- CE-Konformitätserklärung

Ø mm	≈	L mm	WFL kg	€	📦	📄
M5	3/16	80	115	1,80	100	080010105
M6	1/4	80	160	1,80	100	080010106
M8	5/16	105	300	2,70	25	080010108
M10	3/8	125	470	3,50	20	080010110
M11	7/16	135	580	4,40	15	080010111
M12	1/2	140	690	4,60	20	080010112
M14	9/16	170	940	6,60	15	080010114
M16	5/8	190	1290	8,70	15	080010116
M18	11/16	205	1660	13,80	10	080010118

Ø mm	≈	L mm	WFL kg	€	📦	📄
M20	3/4	220	2130	15,90	10	080010120
M22	7/8	240	2630	20,20	8	080010122
M24	1"	260	3060	24,60	5	080010124
M27	1 1/8	270	4000	38,50	1	080010127
M30	1 3/16	280	4860	48,50	1	080010130
M33	1 1/4	290	6040	53,50	1	080010133
M36	1 3/8	300	6500	68,50	1	080010136
M39	1 1/2	300	7900	82,00	1	080010139

Sonderverpackungen für den freien Service



Ø mm	📦	€	📄
M5	2	4,90	1 080019305
M6	2	5,40	1 080019306
M8	1	4,40	1 080019108
M10	1	5,00	1 080019110
M11	1	6,00	1 080019111
M12	1	6,20	1 080019112
M14	1	8,20	1 080019114
M16	1	10,50	1 080019116
M18	1	15,50	1 080019118
M20	1	17,40	1 080019120
M22	1	22,00	1 080019122
M24	1	26,50	1 080019124

8001TZ

Rohrspannschlossmutter, verzinkt



DIN 1478

TECHNISCHE DATEN

• Mindest-Sicherheitskoeffizient: 4

LABORANALYSEN

- chemische Analyse
- Zerreißprobe

VERFÜGBARE ZERTIFIKATIONEN

- Produktspezifikation
- Abnahmeprüfzeugnis Typ 2.2 UNI EN10204
- CE-Konformitätserklärung

Ø mm	≈	L mm	WFL kg	€	📦	📄
M12	1/2	125	690	7,60	10	080010512
M16	5/8	170	1290	11,50	5	080010516
M20	3/4	200	2130	15,20	5	080010520
M24	1	255	3060	26,50	3	080010524
* M27	1.1/8	255	4000	36,00	1	080010527
M30	1.3/16	255	4860	40,50	1	080010530
M36	1.3/8	295	6500	72,50	1	080010536
M42	1.5/8	330	9700	102,00	1	080010542

Sonderverpackungen für den freien Service



Ø mm	📦	€	📄
M12	1	9,10	1 080019512
M16	1	12,80	1 080019516
M20	1	16,50	1 080019520
M24	1	27,50	1 080019524

8002ZD

Ösen für Spannschlösser,
Rechtsgewinde, verzinkt

Auf Anfrage mit linksgängigem Gewinde



TECHNISCHE DATEN

• Mindest-Sicherheitskoeffizient: 4

LABORANALYSEN

- chemische Analyse
- Zerreißprobe

VERFÜGBARE ZERTIFIKATIONEN

- Produktspezifikation
- Abnahmeprüfzeugnis Typ 2.2 UNI EN10204

Ø mm	≈ "	E mm	WFL kg	€	📦	🚚
M5	3/16	37	115	0,60	200	080020105
M6	1/4	40	160	0,90	150	080020106
M8	5/16	52	300	1,10	100	080020108
M10	3/8	60	470	1,80	100	080020110
M11	7/16	65	580	2,40	1	080020111
M12	1/2	72	690	2,90	50	080020112
M14	9/16	85	940	3,60	1	080020114
M16	5/8	95	1290	6,00	1	080020116
M18	11/16	103	1660	8,70	1	080020118
M20	3/4	110	2130	9,80	1	080020120
M22	7/8	120	2630	14,20	1	080020122
M24	1"	130	3060	18,10	1	080020124
M27	1 1/8	135	4000	24,80	1	080020127
M30	1 3/16	140	4860	29,00	1	080020130
M33	1 1/4	148	6040	35,50	1	080020133
M36	1 3/8	150	6500	42,50	1	080020198
M39	1 1/2	150	7900	50,00	1	080020199

Ø mm	≈ "	E mm	WFL kg	€	📦	🚚
M5	3/16	37	115	0,60	1	080020305
M6	1/4	40	160	0,90	1	080020306
M8	5/16	52	300	1,10	1	080020308
M10	3/8	60	470	1,80	1	080020310
M11	7/16	65	580	2,40	1	080020311
M12	1/2	72	690	2,90	1	080020312
M14	9/16	85	940	3,60	1	080020314
M16	5/8	95	1290	6,00	1	080020316
M18	11/16	103	1660	8,70	1	080020318
M20	3/4	110	2130	9,80	1	080020320
M22	7/8	120	2630	14,20	1	080020322
M24	1"	130	3060	18,10	1	080020324
M27	1 1/8	135	4000	24,80	1	080020327
M30	1 3/16	140	4860	29,00	1	080020330
M33	1 1/4	148	6040	35,50	1	080020333
M36	1 3/8	150	6500	42,50	1	080020398
M39	1 1/2	150	7900	50,00	1	080020399



8003ZD

Haken für Spannschlösser,
Rechtsgewinde, verzinkt

Auf Anfrage mit linksgängigem Gewinde



TECHNISCHE DATEN

• Mindest-Sicherheitskoeffizient: 4

LABORANALYSEN

- chemische Analyse
- Zerreißprobe

VERFÜGBARE ZERTIFIKATIONEN

- Produktspezifikation
- Abnahmeprüfzeugnis Typ 2.2 UNI EN10204

Ø mm	≈ "	E mm	WFL kg	€	📦	🚚
M5	3/16	40	25	0,90	150	080030105
M6	1/4	40	45	1,00	120	080030106
M8	5/16	52	95	1,30	100	080030108
M10	3/8	60	140	2,40	70	080030110
M11	7/16	65	165	3,20	1	080030111
M12	1/2	70	300	3,90	30	080030112
M14	9/16	85	420	6,00	1	080030114
M16	5/8	95	570	8,90	1	080030116
M18	11/16	103	700	11,90	1	080030118
M20	3/4	110	900	16,10	1	080030120
M22	7/8	120	1100	20,90	1	080030122
M24	1"	130	1300	32,00	1	080030124
M27	1 1/8	135	2300	38,00	1	080030127

Ø mm	≈ "	WFL kg	E mm	€	📦	🚚
M5	3/16	40	25	0,90	1	080030305
M6	1/4	40	45	1,00	1	080030306
M8	5/16	52	95	1,30	1	080030308
M10	3/8	60	140	2,40	1	080030310
M11	7/16	65	165	3,20	1	080030311
M12	1/2	70	300	3,90	1	080030312
M14	9/16	85	420	6,00	1	080030314
M16	5/8	95	570	8,90	1	080030316
M18	11/16	103	700	11,90	1	080030318
M20	3/4	110	900	16,10	1	080030320
M22	7/8	120	1100	20,90	1	080030322
M24	1"	130	1300	32,00	1	080030324
M27	1 1/8	135	2300	38,00	1	080030327

8004ND

Anschweissenden für Spannschlösser
rechtsgängig - schwarz

Auf Anfrage mit linksgängigem Gewinde



TECHNISCHE DATEN

Mindest-Sicherheitskoeffizient: 4

LABORANALYSEN

- chemische Analyse
- Zerreißprobe

VERFÜGBARE ZERTIFIKATIONEN

- Produktspezifikation
- Abnahmeprüfzeugnis Typ 2.2 UNI EN10204

Ø mm	≈ "	E mm	WFL kg	€	📦	🚚
M5	3/16	40	115	0,70	1	080040005
M6	1/4	44	160	0,90	1	080040006
M8	5/16	53	300	0,82	1	080040008
M10	3/8	63	470	1,30	1	080040010
M12	1/2	70	690	2,10	1	080040012
M14	9/16	85	940	2,80	1	080040014
M16	5/8	95	1290	3,80	1	080040016
M18	11/16	103	1660	5,10	1	080040018
M20	3/4	110	2130	6,50	1	080040020
M22	7/8	120	2630	7,90	1	080040022
M24	1"	130	3060	11,30	1	080040024
M27	1 1/8	135	4000	17,90	1	080040027
M30	1 3/16	140	4860	22,20	1	080040030
M33	1 1/4	150	6040	22,90	1	080040033
M36	1 3/8	150	6500	30,50	1	080040098
M39	1 1/2	150	7900	33,00	1	080040099

Ø mm	≈ "	E mm	WFL kg	€	📦	🚚
M5	3/16	40	115	0,70	1	080040105
M6	1/4	44	160	0,90	1	080040106
M8	5/16	53	300	0,82	1	080040108
M10	3/8	63	470	1,30	1	080040110
M12	1/2	70	690	2,10	1	080040112
M14	9/16	85	940	2,80	1	080040114
M16	5/8	95	1290	3,80	1	080040116
M18	11/16	103	1660	5,10	1	080040118
M20	3/4	110	2130	6,50	1	080040120
M22	7/8	120	2630	7,90	1	080040122
M24	1"	130	3060	11,30	1	080040124
M27	1 1/8	135	4000	17,90	1	080040127
M30	1 3/16	140	4860	22,20	1	080040130
M33	1 1/4	150	6040	22,90	1	080040133
M36	1 3/8	150	6500	30,50	1	080040198
M39	1 1/2	150	7900	33,00	1	080040199



8009FD

Gabeln für Spannschlösser
rechtsgängig - verzinkt
Auf Anfrage mit linksgängigem Gewinde

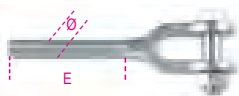

TECHNISCHE DATEN

Mindest-Sicherheitskoeffizient: 4

LABORANALYSEN

- chemische Analyse
- Zerreißprobe

VERFÜGBARE ZERTIFIKATIONEN

- Produktspezifikation
- Abnahmeprüfzeugnis Typ 2.2 UNI EN10204

Ø mm	≈ mm	E mm	WFL kg	€		
M8	5/16	53	300	6,30	1	080090208
M10	3/8	63	470	7,40	1	080090210
M12	1/2	70	690	10,00	1	080090212
M14	9/16	85	940	13,80	1	080090214
M16	5/8	95	1290	15,70	1	080090216
M18	11/16	103	1660	22,20	1	080090218
M20	3/4	110	2130	22,90	1	080090220
M22	7/8	120	2630	34,00	1	080090222
M24	1"	130	3060	37,50	1	080090224
M27	1 1/8	135	4000	58,50	1	080090227
M30	1 3/16	140	4860	76,00	1	080090230

Gabeln für Spannschlösser, rechtsgängig -
verzinkt

Ø mm	≈ mm	WFL kg	G mm	€		
M8	5/16	53	300	6,30	1	080090408
M10	3/8	63	470	7,40	1	080090410
M12	1/2	70	690	10,00	1	080090412
M14	9/16	85	940	13,80	1	080090414
M16	5/8	95	1290	15,70	1	080090416
M18	11/16	103	1660	22,20	1	080090418
M20	3/4	110	2130	22,90	1	080090420
M22	7/8	120	2630	33,00	1	080090422
M24	1"	130	3060	37,50	1	080090424
M27	1 1/8	135	4000	58,50	1	080090427
M30	1 3/16	140	4860	76,00	1	080090430

8048

Augenschrauben, Rechtsgewinde,
schwarz

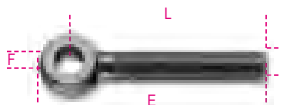

UNI 6058

ØxL mm	WFL kg	F mm	E mm	€		
M8x50	430	6	39	4,00	20	080480108
M8x65	430	6	54	4,40	20	080480109
M10x80	690	8	66	6,70	10	080480110
M10x100	690	8	86	6,80	10	080480210
M10x130	690	8	116	7,40	10	080480111
M12x70	1020	10	53	6,90	8	080480212
M12x95	1020	10	78	7,00	8	080480112
M12x125	1020	10	108	8,50	8	080480113
M14x110	1420	12	91	9,60	6	080480114
M16x100	1980	14	79	7,90	6	080480115
M16x130	1980	14	109	8,20	6	080480116
M18x150	2390	16	126	18,50	2	080480118
M20x160	3100	18	134	22,90	2	080480120
M22x180	3890	18	152	36,00	1	080480122
M24x200	4460	20	168	41,00	1	080480124
M24x220	4460	20	188	44,00	1	080480125
M27x220	5900	22	185	53,00	1	080480127

8302Z

Dübelösen, Rechtsgewinde, verzinkt



TECHNISCHE DATEN

• Mindest-Sicherheitskoeffizient: 4

VERFÜGBARE ZERTIFIKATIONEN

- Produktspezifikation
- Abnahmeprüfzeugnis Typ 2.2 UNI EN10204

Ø mm	E mm	F mm	WFL kg	€		
M5	48	8	115	0,70	200	083020005
M6	55	10	160	0,90	150	083020006
M8	60	12	300	1,10	100	083020008
M10	73	14	470	1,90	100	083020010
M12	90	17	690	3,50	50	083020012

Spezielle Verpackungen
Dübelösen



Ø mm	E mm	WFL kg	€		
M5	48	100	71,00	1	083020705
M6	55	75	65,00	1	083020706
M8	60	50	58,00	1	083020708
M10	73	50	99,00	1	083020710
M12	90	25	96,00	1	083020712

8303Z

Dübelhaken, Rechtsgewinde, verzinkt



TECHNISCHE DATEN

• Mindest-Sicherheitskoeffizient: 4

VERFÜGBARE ZERTIFIKATIONEN

- Produktspezifikation
- Abnahmeprüfzeugnis Typ 2.2 UNI EN10204

Ø mm	C mm	E mm	WFL kg	€		
M5	6,0	48	25	0,90	120	083030005
M6	8,0	55	45	0,82	100	083030006
M8	10,0	60	95	1,40	75	083030008
M10	12,5	73	140	2,40	50	083030010
M12	16,0	90	220	3,80	20	083030012

Spezielle Verpackungen
Dübelhaken



Ø mm	C mm	WFL kg	€		
M5	6,0	60	50,00	1	083030705
M6	8,0	50	46,00	1	083030706
M8	10,0	30	45,00	1	083030708
M10	12,5	25	63,00	1	083030710
M12	16,0	10	42,00	1	083030712

8702N - 8702Z - 8702ZC

Presskabelschuhe aus geschmiedetem Stahl

Augterminals
schwarz



TECHNISCHE DATEN

• Herstellungsnummer

LABORANALYSEN

- chemische Analyse
- Zerreißprobe

VERFÜGBARE ZERTIFIKATIONEN

- Produktspezifikation
- Abnahmeprüfzeugnis Typ 2.2 UNI EN10204
- Prüfbescheinigung Typ 3.1 UNI EN10204

M	ø B mm	ø A mm	ø D mm	€		
6	6,8	13	19	53,00	1	087020106
8	8,8	20	22	63,50	1	087020108
9	9,8	20	22	63,50	1	087020109
10	10,8	20	22	63,50	1	087020110
11	11,8	25	27	79,00	1	087020111
12	12,8	25	27	79,00	1	087020112
13	13,8	25	27	79,00	1	087020113
14	14,8	32	32	109,50	1	087020114
15	15,9	32	32	109,50	1	087020115
16	17,0	32	32	109,50	1	087020116
18	19,0	39	37	142,00	1	087020118
19	20,0	39	37	142,00	1	087020119
20	21,1	39	37	142,00	1	087020120
22	23,2	43	43	197,00	1	087020122
24	25,4	50	52	227,50	1	087020124
25	26,4	50	52	227,50	1	087020125
26	27,4	50	52	227,50	1	087020126

Die Pressung der Kabelschuhe erfordert geeignete
Pressen und Pressformen und darf nur von
Fachpersonal durchgeführt werden.

8702Z verzinkt

M	ø B mm	ø A mm	ø D mm	€		
6	6,8	13	19	55,50	1	087020306
8	8,8	20	22	67,00	1	087020308
9	9,8	20	22	67,00	1	087020309
10	10,8	20	22	67,00	1	087020310
11	11,8	25	27	82,00	1	087020311
12	12,8	25	27	82,00	1	087020312
13	13,8	25	27	82,00	1	087020313
14	14,8	32	32	115,00	1	087020314
15	15,9	32	32	115,00	1	087020315
16	17,0	32	32	115,00	1	087020316
18	19,0	39	37	148,50	1	087020318
19	20,0	39	37	148,50	1	087020319
20	21,1	39	37	148,50	1	087020320
22	23,2	43	43	185,50	1	087020322
24	25,4	50	52	237,50	1	087020324
25	26,4	50	52	237,50	1	087020325
26	27,4	50	52	237,50	1	087020326

8702ZC feuerverzinkt

M	ø B mm	ø A mm	ø D mm	€		
6	6,8	13	19	58,50	1	087020206
8	8,8	20	22	72,50	1	087020208
9	9,8	20	22	72,50	1	087020209
10	10,8	20	22	72,50	1	087020210
11	11,8	25	27	90,00	1	087020211
12	12,8	25	27	90,00	1	087020212
13	13,8	25	27	90,00	1	087020213
14	14,8	32	32	133,00	1	087020214
15	15,9	32	32	133,00	1	087020215
16	17,0	32	32	133,00	1	087020216
18	19,0	39	37	171,50	1	087020218
19	20,0	39	37	171,50	1	087020219
20	21,1	39	37	171,50	1	087020220
22	23,2	43	43	233,00	1	087020222
24	25,4	50	52	272,00	1	087020224
25	26,4	50	52	272,00	1	087020225
26	27,4	50	52	272,00	1	087020226

8709N - 8709Z - 8709ZC

Presskabelschuhe aus geschmiedetem Stahl

Gabelterminal

schwarz



TECHNISCHE DATEN

• Herstellungsnummer

LABORANALYSEN

• chemische Analyse

• Zerreißprobe

VERFÜGBARE ZERTIFIKATIONEN

• Produktspezifikation

• Abnahmeprüfzeugnis Typ 2.2 UNI EN10204

• Prüfbescheinigung Typ 3.1 UNI EN10204

M	ø B mm	ø A mm	ø C mm	€		
6	6,8	13	17	72,50	1	087090106
8	8,8	20	21	94,00	1	087090108
9	9,8	20	21	94,00	1	087090109
10	10,8	20	21	94,00	1	087090110
11	11,8	25	25	117,50	1	087090111
12	12,8	25	25	117,50	1	087090112
13	13,8	25	25	117,50	1	087090113
14	14,8	32	30	163,50	1	087090114
15	15,9	32	30	163,50	1	087090115
16	17,0	32	30	163,50	1	087090116
18	19,0	39	35	212,00	1	087090118
19	20,0	39	35	212,00	1	087090119
20	21,1	39	35	212,00	1	087090120
22	23,2	43	41	271,00	1	087090122
24	25,4	50	51	279,00	1	087090124
25	26,4	50	51	279,00	1	087090125
26	27,4	50	51	279,00	1	087090126

Die Pressung der Kabelschuhe erfordert geeignete Pressen und Pressformen und darf nur von Fachpersonal durchgeführt werden.

8709Z verzinkt

M	ø B mm	ø A mm	ø C mm	€		
6	6,8	13	17	75,00	1	087090306
8	8,8	20	21	98,50	1	087090308
9	9,8	20	21	98,50	1	087090309
10	10,8	20	21	98,50	1	087090310
11	11,8	25	25	122,50	1	087090311
12	12,8	25	25	122,50	1	087090312
13	13,8	25	25	122,50	1	087090313
14	14,8	32	30	171,50	1	087090314
15	15,9	32	30	171,50	1	087090315
16	17,0	32	30	171,50	1	087090316
18	19,0	39	35	222,50	1	087090318
19	20,0	39	35	222,50	1	087090319
20	21,0	39	35	222,50	1	087090320
22	23,2	43	41	291,00	1	087090322
24	25,4	50	51	291,00	1	087090324
25	26,4	50	51	291,00	1	087090325
26	27,4	50	51	291,00	1	087090326

8709ZC feuerverzinkt

M	ø B mm	ø A mm	ø C mm	€		
6	6,8	13	17	77,50	1	087090206
8	8,8	20	21	103,50	1	087090208
9	9,8	20	21	103,50	1	087090209
10	10,8	20	21	103,50	1	087090210
11	11,8	25	25	133,50	1	087090211
12	12,8	25	25	133,50	1	087090212
13	13,8	25	25	133,50	1	087090213
14	14,8	32	30	194,00	1	087090214
15	15,9	32	30	194,00	1	087090215
16	17,0	32	30	194,00	1	087090216
18	19,0	39	35	247,00	1	087090218
19	20,0	39	35	247,00	1	087090219
20	21,1	39	35	247,00	1	087090220
22	23,2	43	41	315,00	1	087090222
24	25,4	50	51	346,00	1	087090224
25	26,4	50	51	346,00	1	087090225
26	27,4	50	51	346,00	1	087090226

DRAHTSEILKLEMMEN



Professionelle Drahtseilklemmen ermöglichen die Bildung von Schlaufen aus Litzenseilen mit Stahleinlage, die zum Verankern und Spannen verwendet werden. Im Gegensatz zu vielen anderen Produkten auf dem Markt hat unsere Klemme KEINEN Gusseisenkörper.

Denn um die besten mechanischen Leistungen auch bei schwierigen Anwendungen zu gewährleisten, ist der Sockel heiß geschmiedet und hat ein durchschnittlich höheres Gewicht als vergleichbare Produkte.

Eine hochwertige elektrolytische Verzinkung ohne sechswertiges Chrom gewährleistet eine gute Korrosionsbeständigkeit und bessere Optik.

Im Laufe der jahrzehntelangen Firmengeschichte haben all diese charakteristischen Merkmale den Artikel 8016 zur Ikone der Marke Robur gemacht und zeichnen die Klemme „der italienischen Art“ weltweit aus.

8015

Drahtseilklemmen, amerikanischer Typ, Körper aus Stahl, feuerverzinkt

CE

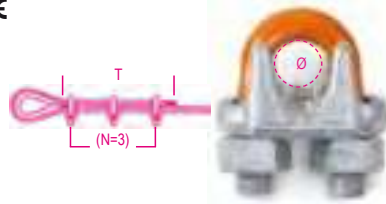

dimensioni EN 13411-5 tipo B

TECHNISCHE DATEN

• Identifizierungskode

LABORANALYSEN

• Chemische Analyse

• Drehmomenttest

VERFÜGBARE ZERTIFIKATIONEN

• Produktspezifikation

• Abnahmeprüfzeugnis Typ 2.2 UNI EN10204

• Herstellerbescheinigung UNI EN13411-5

• CE-Konformitätserklärung

ø mm	ø "	N x T	Nm	€		
8	5/16	3x133	40,7	2,70	12	080150808
10	3/8	3x165	61	3,80	12	080150810
13	1/2	3x292	88	5,80	6	080150813
16	5/8	3x305	129	8,10	6	080150816
20	3/4	4x460	176	11,10	6	080150820
22	7/8	4x480	305	17,60	6	080150822
26	1	5x660	305	19,20	5	080150826
30	1-1/8	6x860	305	20,50	2	080150830

8016

Drahtseilklemmen aus Stahl, verzinkt

CE

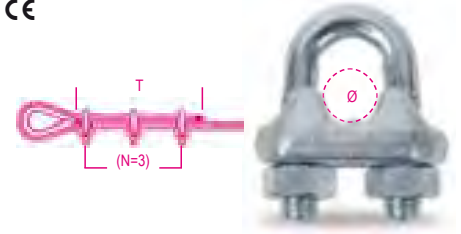

LABORANALYSEN

• chemische Analyse

• Drehmomentstest

VERFÜGBARE ZERTIFIKATIONEN

• Produktspezifikation

• Abnahmeprüfzeugnis Typ 2.2 UNI EN10204

* CE-Konformitätserklärung

ø mm	ø "	N x T	Nm	€		
3	1/8	3x80	1,53	0,90	500	080160003
5	3/16	3x110	3,02	1,10	300	080160005
6	1/4	3x120	5,19	1,10	200	080160006
8	5/16	5x210	5,19	1,30	150	080160008
10	3/8	5x240	12,54	2,00	70	080160010
11	7/16	5x260	12,54	2,10	70	080160011
12-13	1/2	5x300	24,76	2,80	40	080160013
14	9/16	5x295	24,76	3,10	35	080160014
16	5/8	5x335	24,76	3,50	30	080160016
18	11/16	5x380	42,42	4,80	30	080160018
20	3/4	5x540	42,42	5,10	30	080160020
22	7/8	7x595	42,42	6,00	25	080160022
24-26	1"	7x700	67,56	8,20	15	080160026
28	1-1/16	8x840	67,56	10,30	5	080160028
30-32	1-1/8	8x990	67,56	10,30	5	080160030
34-36	1-1/4	8x1155	105,80	13,60	4	080160034
38-40	1-1/2	8x1320	105,80	18,30	2	080160040
45-50	2"	8x1500	206	28,00	1	080160050

Spezial-Verpackung



ø mm	ø "	N x T	Nm	€		
3	1/8	100		80,50	1	080160703
5	3/16	50		51,00	1	080160705
6	1/4	50		56,50	1	080160706
8	5/16	30		41,50	1	080160708
10	3/8	30		63,50	1	080160710
11	7/16	25		56,50	1	080160711
12-13	1/2	15		45,50	1	080160713

Sonderverpackungen für den freien Service



ø mm	€		
3	5,60	1	080169403
5	4,80	1	080169405
6	5,40	1	080169406
8	6,20	1	080169408
10	5,00	1	080169410
11	3,60	1	080169011
12-13	4,40	1	080169013
14	4,50	1	080169014
16	5,00	1	080169016
18	6,30	1	080169018
20	6,50	1	080169020
22	7,60	1	080169022
24-26	9,90	1	080169026

8016FR

Drahtseilklemmen aus Stahl,
mit kalt gepresstem Körper, verzinkt

CE

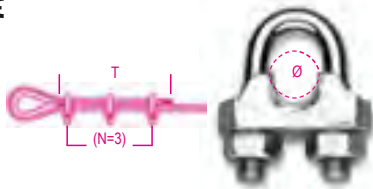

LABORANALYSEN

- chemische Analyse
- VERFÜGBARE ZERTIFIKATIONEN
- Produktspezifikation
- Abnahmeprüfzeugnis Typ 2.2 UNI EN10204
- CE-Konformitätserklärung

Ø mm	Ø mm	N x T	Nm	€		
3	1/8	3x80	1,25	0,70	500	080160253
5	3/16	3x110	2,46	0,82	300	080160255
6	1/4	3x120	4,24	1,10	200	080160256
8	5/16	5x210	4,24	1,20	150	080160258

8018E

Gusseisen,
verzinkt



LABORANALYSEN

- chemische Analyse
- VERFÜGBARE ZERTIFIKATIONEN
- Produktspezifikation
- Abnahmeprüfzeugnis Typ 2.2 UNI EN10204

Ø mm	A mm	L mm	Nm	€		
4÷6	M6	34	4,24	1,60	100	080180001



Robur

8016U2

Drahtseilklemmen

CE

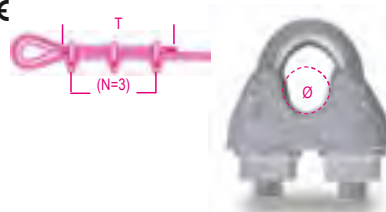

dimensioni EN 13411-5 tipo A

TECHNISCHE DATEN

- Identifizierungscode
- LABORANALYSEN
- chemische Analyse
- Drehmomentstest
- VERFÜGBARE ZERTIFIKATIONEN
- Produktspezifikation
- Abnahmeprüfzeugnis Typ 2.2 UNI EN10204
- Herstellerzertifikat UNI EN 13411-5
- CE-Konformitätserklärung

Ø mm	Ø "	N x T	Nm	€		
5	3/16	3x156	2,0	0,50	300	080160855
6,5	1/4	3x192	3,5	0,60	150	080160856
8	5/16	4x320	6	1,20	70	080160858
10	3/8	4x320	9	1,20	60	080160860
12	1/2	4x384	20	2,20	25	080160862
14	9/16	4x448	33	3,40	15	080160864
16	5/8	4x512	49	5,00	10	080160866
19	3/4	4x512	68	5,80	10	080160869
22	7/8	5x680	107	8,20	10	080160872
26	1	5x760	147	14,80	5	080160876
30	1.1/8	6x984	212	19,00	5	080160880
34	1.1/4	6x1080	296	26,00	5	080160884
40	1.1/2	6x1176	363	32,00	5	080160890

Sonderverpackungen für den freien Service

Ø mm		€	
5	4	4,80	1 080169805
6	4	6,00	1 080169806
8	4	9,20	1 080169808
10	2	6,20	1 080169810
12	1	6,00	1 080169612
14	1	6,90	1 080169614
16	1	9,20	1 080169616
19	1	10,00	1 080169619
22	1	13,10	1 080169622
26	1	21,30	1 080169626

8016UGK

Drahtseilklemmen
aus Temporguss
HEIßVERZINKTER Körper
Bügel und Schraubenmuttern GEOMET-
GEEKOTE

CE



- Hohe

Korrosionsbeständigkeit
- Identifizierungskode

dimensioni EN 13411-5 tipo A

TECHNISCHE DATEN

- Identifizierungscode
- LAVOR ANALYSEN
- chemische Analyse
- Drehmomenttest
- VERFÜGBARE ZERTIFIKATIONEN
- Produktspezifikation
- Abnahmeprüfzeugnis Typ 2.2 UNI EN10204
- Herstellerbescheinigung UNI EN13411-5
- CE-Konformitätserklärung

Ø mm	Ø "	N x T	Nm	€		
8	5/16	4x320	6	2,20	70	080160758
10	3/8	4x320	9	2,50	60	080160760
12	1/2	4x448	33	4,40	25	080160762
14	9/16	4x384	20	6,20	15	080160764
16	5/8	4x512	49	9,20	10	080160766
19	3/4	4x512	68	10,30	10	080160769
22	7/8	5x680	107	14,80	10	080160772
26	1	5x760	147	24,20	5	080160776
30	1.1/8	6x984	212	29,00	1	080160780
34	1.1/4	6x1080	296	41,50	1	080160784
40	1.1/2	6x1176	363	51,50	1	080160790

8018T

Gusseisen, verzinkt



RUM-MU-21:1980

LABORANALYSEN

- chemische Analyse
- VERFÜGBARE ZERTIFIKATIONEN
- Produktspezifikation
- Abnahmeprüfzeugnis Typ 2.2 UNI EN10204

Ø mm	A mm	L mm	Nm	€		
8÷10	M8	42	10,20	1,60	200	080180003



8020A

Kauschen, leichtes Modell, verzinkt

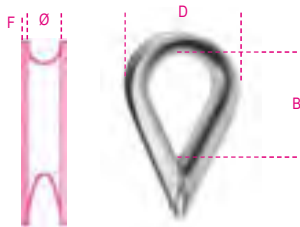

VERFÜGBARE ZERTIFIKATIONEN

- Produktspezifikation
- Abnahmeprüfzeugnis Typ 2.2 UNI EN10204

Ø mm	F mm	B mm	D mm	€	📦	🚚
2-3	1,0	20	18	0,40	150	080200503
4	1,2	23	19	0,40	150	080200504
5	1,2	24	23	0,40	100	080200505
6	1,2	27	28	0,50	100	080200506
8	1,4	33	32	0,60	50	080200508
10	1,8	41	38	0,90	30	080200510
12	2,2	44	45	1,10	30	080200512
14	2,2	52	49	1,40	50	080200514
16	3,0	58	58	1,90	50	080200516
18	3,7	64	68	2,70	50	080200518
20	3,7	73	74	3,40	35	080200520
22	3,7	83	79	3,80	30	080200522
24	3,7	93	88	5,00	20	080200525

Spezial-Verpackung



Ø mm	S mm	📦	€	🚚	🚚
2-3	0,8	150	43,00	1	080200703
4	1,0	150	44,50	1	080200704
5	1,0	100	35,50	1	080200705
6	1,0	100	35,50	1	080200706
8	1,2	50	28,00	1	080200708
10	1,5	30	24,90	1	080200710

8021A

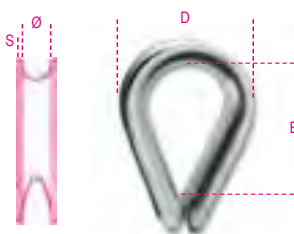

Ø mm	S mm	B mm	D mm	€	📦	🚚
2-3	0,6	15	16	0,50	150	080210103
5	1,7	29	28	0,70	120	080210105
6	1,8	33	30	0,70	100	080210106
8	2,5	36	37	1,00	100	080210108
10	2,5	42	43	1,20	80	080210110
12	2,5	48	50	1,60	100	080210112
14	2,7	58	57	2,00	70	080210114
16	3	61	62	2,50	50	080210116
18	3,5	71	71	3,20	70	080210118
20	4	79	79	4,80	30	080210120
22	4	87	84	5,50	25	080210122
24	4	93	92	6,40	25	080210124
26	4	103	103	7,90	20	080210126
28	5	107	116	18,50	1	080210128
30	5	118	121	18,50	1	080210130
32	5,5	138	135	22,20	1	080210132
35	6	140	147	31,00	1	080210135
40	6,0	174	170	44,00	1	080210140

SCHÄKEL



Die hochfesten Schäkel Robur werden im Gegensatz zu ähnlichen Produkten vollständig aus gehärtetem und vergütetem Chrom-Molybdän-Stahl hergestellt und sind so ausgelegt, dass sie in Labortests 20.000 Zyklen unter Vollast standhalten. Aus diesen Gründen stehen sie an der Spitze ihrer Klasse und da sie einen höheren Sicherheitskoeffizienten als die Referenznorm (6:1 statt 5:1) und auch bei niedrigen Temperaturen eine ausgezeichnete Widerstandsfähigkeit aufweisen, können sie die beste Wahl für Schwerlastanwendungen sein.

Die Weichstahlschäkel Robur sind dank der Güte des Rohmaterials, der Bearbeitungssorgfalt und das Normalisieren eine Garantie für Zuverlässigkeit und Langlebigkeit und ermöglichen so eine höhere Arbeitslast und einen höheren Sicherheitsfaktor als vergleichbare Produkte auf dem Markt.

Die eindeutige und unauslöschliche Kennzeichnung auf jedem Stück ermöglicht es, die Herkunft des Schäkels auch bei Kontrollen durch Prüfungsgesellschaften oder zuständige Behörden zu ermitteln.

8026R

Hochfeste gerade Schäkel, aus legiertem Stahl, Bügel heiß verzinkt

CE

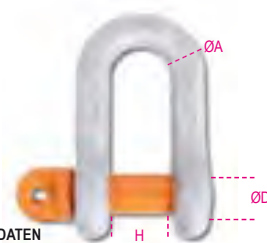

EN 13889

TECHNISCHE DATEN

- Mindest-Sicherheitskoeffizient: 6
- Wärmebehandlung: Vergütung
- Herstellungsnummer auf Bolzen und Bügel

LABORANALYSEN

- chemische Analyse • metallographische Analyse
- Zerreißprobe • Ermüdungstest (min. 20.000 Zyklen)
- Probebelastungstest (2 x WLL)

VERFÜGBARE ZERTIFIKATIONEN

- Produktspezifikation
- Abnahmeprüfzeugnis Typ 2.2 UNI EN10204
- Prüfbescheinigung Typ 3.1 UNI EN10204
- CE-Konformitätserklärung

ØD mm	ØA mm	H mm	WLL kg	€	📦	🚚
11	10	17	1000	7,20	5	080260210
16	13	21	2000	13,40	5	080260212
19	16	27	3250	22,50	3	080260216
22	19	32	4750	33,00	2	080260219
25	22	37	6500	50,00	2	080260222

Sonderverpackungen für den freien Service



ØD mm	📦	€	🚚	🚚
16	1	14,60	1	080269212
19	1	24,20	1	080269216

8029R

Hochfeste herzförmige Schäkel, aus legiertem Stahl, Bügel heiß verzinkt

CE



EN 13889

TECHNISCHE DATEN

- Mindest-Sicherheitskoeffizient: 6
- Wärmebehandlung: Vergütung
- Herstellungsnummer auf Bolzen und Bügel

LABORANALYSEN

- Chemische Analyse
- Metallographische Analyse
- Zerreißprobe
- Ermüdungstest (min. 20.000 Zyklen)
- Probebelastungstest (2 x WLL)

VERFÜGBARE ZERTIFIKATIONEN

- Produktspezifikation
- Abnahmeprüfzeugnis Typ 2.2 UNI EN10204
- Prüfbescheinigung Typ 3.1 UNI EN10204
- CE-Konformitätserklärung

ØD mm	ØA mm	H mm	WLL kg	€	📦	🚚
8	6	13	500	4,40	20	080290106
10	8	13,5	750	5,40	15	080290108
11	10	17	1000	7,60	15	080290110
13	11	18,5	1500	10,00	10	080290111
16	13	20,5	2000	10,30	8	080290112
19	16	27	3250	17,60	8	080290116
22	19	32	4750	26,00	4	080290120
25	22	37	6500	38,50	4	080290122
28	26	43,5	8500	53,00	1	080290124

ØD mm	ØA mm	H mm	WLL kg	€	📦	🚚
32	29	48	9500	99,00	1	080290128
35	32	53	12000	132,50	1	080290132
38	35	59	13500	173,50	1	080290135
42	38	62	17000	227,50	1	080290138
50	45	75	25000	389,00	1	080290145
57	50	83	35000	680,00	1	080290150
65	57	95	42500	1.171,00	1	080290157
70	65	105	55000	1.340,00	1	080290165

Sonderverpackungen für den freien Service



ØD mm	📦	€	📦	🚚
8	1	6,00	1	080299106
10	1	6,90	1	080299108
11	1	9,20	1	080299110
13	1	11,60	1	080299111
16	1	11,80	1	080299112
19	1	19,80	1	080299116

Spezielle Verpackungen Schäkel



ØD mm	ØA mm	📦	€	📦	🚚
8	6	10	50,00	1	080290706
10	8	10	60,00	1	080290708
11	10	10	85,00	1	080290710
13	11	5	57,00	1	080290711
16	13	4	46,00	1	080290712
19	16	4	79,00	1	080290716
22	19	2	59,00	1	080290720
25	22	2	87,00	1	080290722

8031R

Hochfeste herzförmige Schäkel mit Splintmutter aus legiertem Stahl, Bügel heiß verzinkt

CE

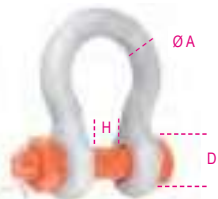

EN 13889

TECHNISCHE DATEN

- Mindest-Sicherheitskoeffizient: 6
- Wärmebehandlung: Vergütung
- Herstellungsnummer auf Bolzen und Bügel

LABORANALYSEN

- Chemische Analyse
- Metallographische Analyse
- Zerreißprobe
- Ermüdungstest (min. 20.000 Zyklen)
- Probelastungstest (2 x WLL)

VERFÜGBARE ZERTIFIKATIONEN

- Produktspezifikation
- Abnahmeprüfzeugnis Typ 2.2 UNI EN10204
- Prüfbescheinigung Typ 3.1 UNI EN10204
- CE-Konformitätserklärung

ØD mm	ØA mm	H mm	WLL kg	€	📦	🚚
11	10	17	1000	8,10	5	080310110
13	11	18	1500	12,50	5	080310111
16	13	21	2000	12,80	5	080310112
19	16	27	3250	21,70	3	080310116
22	19	32	4750	31,00	2	080310120
25	22	37	6500	42,50	2	080310122
28	26	43	8500	63,00	1	080310124

ØA mm	ØD mm	H mm	WLL kg	€	📦	🚚
29	32	48	9500	108,50	1	080310128
32	35	53	12000	140,00	1	080310132
35	38	59	13500	197,00	1	080310135
38	42	62	17000	240,50	1	080310138
45	50	75	25000	421,00	1	080310145
50	57	83	35000	739,00	1	080310150
65	70	105	55000	1.515,00	1	080310165
75	83	127	85000	2.295,00	1	080310183

Sonderverpackungen für den freien Service



ØD mm	📦	€	📦	🚚
16	1	15,70	1	080319112
19	1	26,50	1	080319116

8032

Hochfeste herzförmige Schäkel, Bolzen mit Innenvierkant, aus legiertem Stahl, Bügel heiß verzinkt

CE

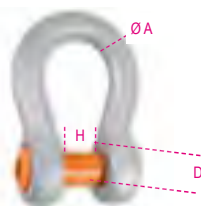

TECHNISCHE DATEN

- Mindest-Sicherheitskoeffizient: 5
- Wärmebehandlung: Vergütung
- Herstellungsnummer auf Bolzen und Bügel

LABORANALYSEN

- chemische Analyse
- metallographische Analyse
- Zerreißprobe
- Ermüdungstest (min. 20.000 Zyklen)
- Probelastungstest (2 x WLL)

VERFÜGBARE ZERTIFIKATIONEN

- Produktspezifikation
- Abnahmeprüfzeugnis Typ 2.2 UNI EN10204
- Prüfbescheinigung Typ 3.1 UNI EN10204
- CE-Konformitätserklärung

ØD mm	ØA mm	H mm	WLL kg	€	📦	🚚
11	10	17	1000	9,60	5	080320010
16	13	21	2000	12,10	5	080320012
19	16	27	3250	22,10	3	080320016
22	19	32	4750	38,00	2	080320020
25	22	37	6500	55,50	2	080320022

Sonderverpackungen für den freien Service



ØD mm	📦	€	📦	🚚
16	1	14,60	1	080329012
19	1	24,20	1	080329016

Robur

8025

Gerade Schäkel, breites Modell, geschmiedet, verzinkt

CE

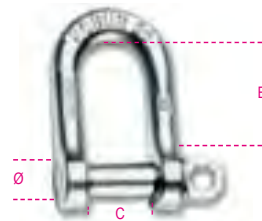

TECHNISCHE DATEN

- Mindest-Sicherheitskoeffizient: 5
- Wärmebehandlung: Normalglühen
- Herstellungsnummer

LABORANALYSEN

- chemische Analyse
- metallographische Analyse
- Zerreißprobe

VERFÜGBARE ZERTIFIKATIONEN

- Produktspezifikation
- Abnahmeprüfzeugnis Typ 2.2 UNI EN10204
- Prüfbescheinigung Typ 3.1 UNI EN10204
- CE-Konformitätserklärung

Ø mm	≈ "	B x C mm	WLL kg	€	📦	🚚
5	3/16	21x10	70	1,80	250	080250005
6	1/4	25x12	100	2,40	250	080250006
8	5/16	33x16	250	3,90	150	080250008
10	3/8	42x20	400	4,40	180	080250010
11	7/16	46x22	500	5,30	130	080250011
12	1/2	50x24	600	5,60	100	080250012
14	9/16	57x28	800	7,30	70	080250014
16	5/8	61x32	1000	9,50	10	080250016
18	11/16	65x36	1300	13,70	10	080250018
20	3/4	70x40	1600	16,00	10	080250020
22	7/8	74x44	2000	22,20	10	080250022
25	1"	80x48	2800	29,50	2	080250025

Spezial-Verpackung



Ø mm	📦	€	📦	🚚	
5	3/16	25	47,50	1	080250705
6	1/4	25	64,50	1	080250706
8	5/16	25	107,00	1	080250708
10	3/8	15	71,00	1	080250710
11	7/16	12	69,50	1	080250711
12	1/2	12	75,00	1	080250712
14	9/16	10	81,00	1	080250714

Sonderverpackungen für den freien Service



Ø mm	📦	€	📦	🚚
5	4	8,50	1	080259205
6	4	10,90	1	080259206
8	2	9,10	1	080259208
10	2	9,80	1	080259210
11	1	6,50	1	080259011
12	1	7,00	1	080259012
14	1	8,50	1	080259014
16	1	10,80	1	080259016
18	1	16,00	1	080259018
20	1	18,10	1	080259020
22	1	23,50	1	080259022
25	1	31,00	1	080259025

8026A

Gerade Schakel - Type A, geschmiedet, verzinkt

CE

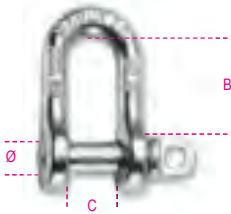

TECHNISCHE DATEN

- Mindest-Sicherheitskoeffizient: 5
- Warmebehandlung: Normalgluhen
- Herstellungsnummer

LABORANALYSEN

- chemische Analyse
- metallographische Analyse
- Zerreiprobe

VERFUGBARE ZERTIFIKATIONEN

- Produktspezifikation
- Abnahmeprufzeugnis Typ 2.2 UNI EN10204
- Prufbescheinigung Typ3.1 UNI EN10204
- CE-Konformitatserklrung

Ø mm	≈	B x C mm	WLL kg	€	📦	🚚
12	1/2	42x20	630	5,40	35	080260012
14	9/16	46x22	800	6,70	30	080260014
16	5/8	50x24	1000	8,50	20	080260016
18	11/16	54x26	1300	12,00	15	080260018
20	3/4	58x28	1600	15,20	10	080260020
22	7/8	69x32	2000	19,80	10	080260022
25	1"	79x36	2500	28,00	5	080260025
28	1.1/8	90x40	3150	38,50	2	080260028
32	1.1/4	100x45	4000	53,00	1	080260032
36	1.3/8	110x50	5000	76,00	1	080260036
40	1.9/16	120x55	6300	105,00	1	080260040
42	1.5/8	131x60	8000	143,50	1	080260042
45	1.3/4	143x65	10000	196,00	1	080260045
50	2"	155x70	12500	243,50	1	080260050

Sonderverpackungen fur den freien Service



Ø mm	📦	€	📦	🚚
12	1	6,90	1	080269012
14	1	8,20	1	080269014
16	1	9,60	1	080269016
18	1	14,60	1	080269018
20	1	17,40	1	080269020
22	1	22,20	1	080269022
25	1	31,00	1	080269025



8028

Herzformige Schakel, geschmiedet, verzinkt

CE

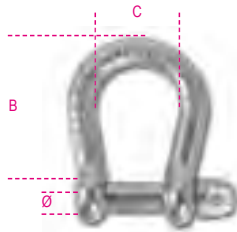

TECHNISCHE DATEN

- Mindest-Sicherheitskoeffizient: 5
- Warmebehandlung: Normalgluhen
- Herstellungsnummer

LABORANALYSEN

- chemische Analyse
- metallographische Analyse
- Zerreiprobe

VERFUGBARE ZERTIFIKATIONEN

- Produktspezifikation
- Abnahmeprufzeugnis Typ 2.2 UNI EN10204
- Prufbescheinigung Typ3.1 UNI EN10204
- CE-Konformitatserklrung

Ø mm	≈	B x C mm	WLL kg	€	📦	🚚
5	3/16	20x16	80	1,60	100	080280105
6	1/4	24x20	100	2,30	70	080280106
8	5/16	32x24	200	3,80	35	080280108
10	3/8	40x33	300	4,40	25	080280110
12	1/2	48x39	500	6,90	15	080280112
14	9/16	56x46	600	9,80	7	080280114
16	5/8	64x46	800	14,70	10	080280116
18	11/16	71x59	950	18,10	5	080280118
20	3/4	80x65	1100	26,00	5	080280120
22	7/8	88x72	1500	33,00	5	080280122
25	1"	100x81	2000	50,00	2	080280125
28	1.1/8	112x91	2600	77,00	1	080280128
32	1.1/4	128x104	3200	105,50	1	080280132
38	1.1/2	152x124	4500	210,00	1	080280138

Sonderverpackungen fur den freien Service



Ø mm	📦	€	📦	🚚
5	4	7,30	1	080289305
6	4	10,50	1	080289306
8	2	9,40	1	080289308
10	2	10,10	1	080289310
12	1	8,40	1	080289112
14	1	11,40	1	080289114
16	1	15,90	1	080289116
18	1	20,20	1	080289118
20	1	28,00	1	080289120
22	1	36,00	1	080289122

8049 WLL (t)

	A°	M8	M10	M12	M16	M20	M24	M30
	0°	0,3	0,6	1	1,6	2,5	4	6,3
	0°	0,6	1,2	2	3,2	5	8	12,6
	90°	0,3	0,6	1	1,6	2,5	4	6,3
	90°	0,6	1,2	2	3,2	5	8	12,6
	0°	0,4	0,8	1,4	2,2	3,5	5,6	8,8
	45°							
	46° 60°	0,3	0,6	1	1,6	2,5	4	6,3
	0°	0,6	1,3	2,1	3,4	5,3	8,4	13,2
	46° 60°	0,3	0,6	1	1,6	2,3	4	6,3

8049

Ringschrauben, ausrichtbar, mit Doppelgelenk, aus hoch resistentem legiertem Stahl

CE

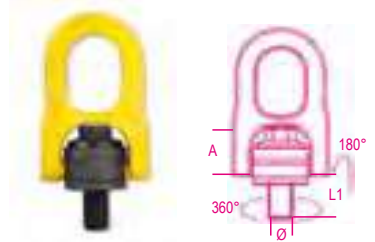

TECHNISCHE DATEN

- Mindest-Sicherheitskoeffizient: 5
- Warmebehandlung: Vergutung
- Herstellungsnummer

LABORANALYSEN

- chemische Analyse
- metallographische Analyse
- Zerreiprobe

VERFUGBARE ZERTIFIKATIONEN

- Ermudungstest (20.000 Zyklen)
- Produktspezifikation
- Abnahmeprufzeugnis Typ 2.2 UNI EN10204
- Prufbescheinigung Typ3.1 UNI EN10204
- CE-Konformitatserklrung

Ø mm	A mm	L1 mm	WLL 90° kg	€	📦	🚚
M8	31,5	14	300	145,00	1	080490008
M10	31,5	17	600	151,50	1	080490010
M12	31,5	21	1000	155,50	1	080490012
M16	45	27	1600	178,50	1	080490016
M20	45	30	2500	183,00	1	080490020
M24	60,5	36	4000	314,00	1	080490024
M30	60,5	45	6300	327,00	1	080490030



8049A WLL (kg)											
	2T	3T	4T	5T	6T	8T	10T	15T	20T	30T	45T
	400	600	800	1000	1200	1600	2000	2800	3600	5400	8100
	600	900	1200	1500	1800	2400	3000	4200	5400	8100	12150
	800	1200	1600	2000	2400	3200	4000	5400	7200	10800	16200
	1000	1500	2000	2500	3000	4000	5000	6600	8400	12600	18900
	1200	1800	2400	3000	3600	4800	6000	8000	10800	16200	24300
	1600	2400	3200	4000	4800	6400	8000	10800	14400	21600	32400
	2000	3000	4000	5000	6000	8000	10000	13200	17100	25650	38475
	3000	4500	6000	7500	9000	12000	15000	20000	27000	40500	60675
	4000	6000	8000	10000	12000	16000	20000	27000	36000	54000	81000
	6000	9000	12000	15000	18000	24000	30000	40000	54000	81000	121500
	8000	12000	16000	20000	24000	32000	40000	54000	72000	108000	162000
	10000	15000	20000	25000	30000	40000	50000	66000	84000	126000	189000

8049A

Ringschrauben mit Doppelgelenk, unter Last dreh- und ausrichtbar, mit verschweißtem Ring aus hoch resistentem legiertem Stahl

CE



TECHNISCHE DATEN

- Mindest-Sicherheitskoeffizient: 4
- Wärmebehandlung: Vergütung
- Herstellungsnummer

LABORANALYSEN

- chemische Analyse
- metallographische Analyse
- Zerreiprobe

- Ermüdungstest (20.000 Zyklen)
- Prüflast (100% der Partie)

VERFÜGBARE ZERTIFIKATIONEN

- Produktspezifikation
- Abnahmeprüfzeugnis Typ 2.2 UNI EN10204
- Prüfbescheinigung Typ 3.1 UNI EN10204
- CE-Konformitätserklärung

Ø	E	A	WLL 90°	€		
mm	mm	mm	kg			
M6	13	30	200	47,50	1	080490106
M8	13	30	300	49,00	1	080490108
M10	19	30	450	51,50	1	080490110
M12	19	30	500	54,50	1	080490112
M16	20	30	1120	58,00	1	080490116
M20	30	40	2000	83,50	1	080490120
M24	30	40	3150	122,00	1	080490124
M30	35	50	5300	211,50	1	080490130
M36	54	50	8000	222,50	1	080490136

8049V

Ringschrauben mit versetztem Bügel, aus hochfestem legiertem Stahl

Um 360° drehbare Ringschraube und schwenkbare Halterung

CE



TECHNISCHE DATEN

- Mindest-Sicherheitskoeffizient: 4
- Wärmebehandlung: Vergütung
- Herstellungsnummer

LABORANALYSEN

- Chemische Analyse
- Metallographische Analyse
- Zerreiprobe
- Ermüdungstest (20.000 Zyklen)
- Prüflast (100% der Partie)

VERFÜGBARE ZERTIFIKATIONEN

- Produktspezifikation
- Abnahmeprüfzeugnis Typ 2.2 UNI EN10204
- Prüfbescheinigung Typ 3.1 UNI EN10204
- CE-Konformitätserklärung

Ø	E	B	WLL	€		
mm	mm	mm	kg			
M10	13,5	37	630	80,50	1	080490310
M12	18	37,5	1000	98,50	1	080490312
M16	24	37,5	1500	105,00	1	080490316
M20	35,5	54	2500	152,50	1	080490320
M24	35,5	54	4000	157,00	1	080490324

8068S

Anschlagpunkte mit einzelner Anschweißbasis und Stellfeder, Bügel aus hochfestem legiertem Stahl

- Minimaler Platzbedarf für Hebevorgänge
- Ausgelegt für 20.000 Arbeitszyklen mit Vollast
- Prüfbelastung von 100 % der Teile vor dem Verkauf
- Sicherheitsfaktor 4 in allen Richtungen

CE



TECHNISCHE DATEN

- Sicherheitsfaktor: 4
- Wärmebehandlung: Vergütung
- Herstellungsnummer

LABORANALYSEN

- chemische Analyse
- metallographische Analyse
- Zerreiprobe
- Ermüdungstest (min. 20.000 Zyklen)
- Probelastungstest (100 % der Partie)

VERFÜGBARE ZERTIFIKATIONEN

- Produktspezifikation
- Abnahmeprüfzeugnis Typ 2.2 UNI EN10204
- Prüfbescheinigung Typ 3.1 UNI EN10204
- CE-Konformitätserklärung

WLL	B	M	A	€		
Kg	mm	mm	mm			
1500	78	37	41	11,90	1	080680115
2500	88	40	42	15,60	1	080680125
4000	94	42	45	22,30	1	080680140
6700	118	51	55	41,50	1	080680167

Achtung: - Das Aufnahmeelement muss eine ausreichende mechanische Festigkeit aufweisen und zum Schweißen geeignet sein. - Das Schweißen muss kompetenten, entsprechend geschulten Schweißern überlassen werden.

8041

Ringschrauben, aus hochfestem legiertem Stahl

CE



TECHNISCHE DATEN

- Mindest-Sicherheitskoeffizient: 4
- Wärmebehandlung: Vergütung
- Herstellungsnummer

LABORANALYSEN

- chemische Analyse
- metallographische Analyse
- Zerreiprobe
- Ermüdungstest (20.000 Zyklen)
- Probelastungstest (100% der Partie)

VERFÜGBARE ZERTIFIKATIONEN

- Produktspezifikation
- Abnahmeprüfzeugnis Typ 2.2 UNI EN10204
- Prüfbescheinigung Typ 3.1 UNI EN10204
- CE-Konformitätserklärung

Ø	E	WLL	€			
mm	mm	kg				
M6	1	11	4,00	10	080410206	
* M8	1,25	13	4,00	10	080410208	
* M10	1,5	17	6,10	6	080410210	
* M12	1,75	20,5	16,00	4	080410212	
M14	2	20,5	30,00	15,20	2	080410214
M16	2,5	27	40,00	22,90	2	080410217
M18	2,5	27	50,00	22,90	2	080410218
M20	3,0	30	60,00	42,50	2	080410221
M22	2,5	30	70,00	42,50	2	080410222
M24	3	36	80,00	51,50	2	080410225
M27	3	41	100,00	78,00	1	080410227
* M30	3,5	45	120,00	78,00	1	080410230

(* Dimensionale Eigenschaften DIN 580:2010

WLL gemäß der technischen Dokumentation und Akte von Robur erhöht

Sonderverpackungen für den freien Service

Ø	€			
mm				
* M8	1	6,30	1	080419208
* M10	1	8,80	1	080419210
* M12	1	12,10	1	080419212

Robur

Robur

8043

Ringmutter,
aus hochfestem legiertem Stahl

CE



TECHNISCHE DATEN

- Mindest-Sicherheitskoeffizient: 4
- Wärmebehandlung: Vergütung
- Herstellungsnummer

LABORANALYSEN

- chemische Analyse
- metallographische Analyse
- Zerreißprobe
- Ermüdungstest (20.000 Zyklen)
- Probelastungstest (100% der Partie)

VERFÜGBARE SPEZIFIKATIONEN

- Produktspezifikation
- Abnahmeprüfzeugnis Typ 2.2 UNI EN10204
- Prüfbescheinigung Typ 3.1 UNI EN10204
- CE-Konformitätserklärung

Ø mm	F mm	WLL kg	€	📦	🚚
M6	1 20	400	3,90	10	080430206
* M8	1,25 20	800	3,90	10	080430208
* M10	1,50 25	1000	6,00	6	080430210
* M12	1,75 30	1600	9,10	4	080430212
M14	2 35	3000	14,80	2	080430214
M16	2 40	4000	21,40	2	080430216
M18	2,5 40	5000	21,40	2	080430218
M20	2,5 50	6000	41,50	2	080430220
M22	2,5 50	7000	41,50	2	080430222
M24	3 55	8000	48,00	2	080430224
M27	3 60	10000	75,00	1	080430227
* M30	3,5 60	12000	75,00	1	080430230

(* Dimensionale Eigenschaften DIN 582:2010

WLL gemäß der technischen Dokumentation und Akte von Robur erhöht

Sonderverpackungen für den freien Service



Ø mm	📦	€	📦	🚚
* M8	1	6,00	1	080439208
* M10	1	8,50	1	080439210
* M12	1	11,60	1	080439212

RINGSCHRAUBEN/ RINGMUTTER



Die Ringschrauben/
Ringmutter Robur sind
aus unlegiertem
Kohlenstoffstahl mit einem
minimalen Prozentsatz
an Aluminium und müssen
die strengen Parameter hinsichtlich der
Korngröße des Materials gemäß DIN580-
582 erfüllen.

Auch die sorgfältige Bearbeitung trägt
dazu bei, den Unterschied auszumachen.
Der Radius des Kragens an der Basis
der Ringschraube/Ringmutter fördert die
Haftung und den vollen Kontakt mit der
Oberfläche des zu hebenden Körpers.
Dank dieser besonderen Eigenschaften
sind unsere Ringschrauben geeignet
für komplexes Heben und intensiven
Gebrauch, z. B. in Umgebungen mit
Dauerbetrieb oder bei Temperaturen
zwischen -20 °C/+200 °C.

8040EZ

Ringschrauben, verzinkt

CE



DIN 580:2018-04(**)

TECHNISCHE DATEN

- Mindest-Sicherheitskoeffizient: 6
- Wärmebehandlung: Normalglühen
- Herstellungsnummer

LABORANALYSEN

- Chemische Analyse
- Metallographische Analyse
- Zerreißprobe

VERFÜGBARE ZERTIFIKATIONEN

- Produktspezifikation
- Abnahmeprüfzeugnis Typ 2.2 UNI EN10204
- Prüfbescheinigung Typ 3.1 UNI EN10204
- CE-Konformitätserklärung

Ø mm	F mm	E mm	WLL kg	€	📦	🚚
* M6	1 11	90	2,20	60	080400406	
M8	1,25 13	140	2,20	60	080400408	
M10	1,5 17	230	2,90	40	080400410	
M12	1,75 20,5	340	3,90	20	080400412	
* M14	2 20,5	480	5,10	20	080400414	
M16	2 27	700	6,30	10	080400416	
* M18	2,5 27	930	7,70	10	080400418	
M20	2,5 30	1200	9,80	10	080400420	
* M22	2,5 30	1450	12,80	10	080400422	
M24	3 36	1800	18,50	5	080400424	
* M27	3 41	2400	22,90	5	080400427	
M30	3,5 45	3200	38,00	2	080400430	
* M33	3,5 54	3900	53,00	2	080400433	
* M33F	2 54	3900	53,00	2	080400434	
M36	4 54	4600	55,00	2	080400436	
* M36F	3 54	4600	55,00	2	080400437	
M42	4,5 63	6300	100,50	1	080400442	
* M42F	3 63	6300	100,50	1	080400443	
M48	5 68	8600	161,50	1	080400448	
* M48F	3 68	8600	161,50	1	080400449	
M56	5,5 78	11500	264,00	1	080400456	
* M56F	4 78	11500	264,00	1	080400457	
M64	6 90	16000	388,00	1	080400464	
* M64F	4 90	16000	388,00	1	080400465	

*Maße gemäß der Technischen Dokumentation Robur

Spezielle Verpackungen Ringschrauben



Ø mm	F mm	📦	€	📦	🚚
M6	1 20	48,00	1	080400906	
M8	1,25 20	48,00	1	080400908	
M10	1,5 20	65,00	1	080400910	
M12	1,75 15	65,00	1	080400912	

Sonderverpackungen für den freien Service



Ø mm	📦	€	📦	🚚
M6	4	10,60	1	080409606
M8	4	10,60	1	080409608
M10	2	7,90	1	080409610
M12	1	5,50	1	080409412
* M14	1	6,50	1	080409414
M16	1	7,90	1	080409416
* M18	1	9,40	1	080409418
M20	1	11,30	1	080409420

Ø mm	📦	€	📦	🚚
* M22	1	14,80	1	080409422
M24	1	19,90	1	080409424
* M27	1	25,00	1	080409427
M30	1	39,00	1	080409430

8040EN

Ringschrauben, schwarz

CE



DIN 580:2018-04(**)

TECHNISCHE DATEN

- Mindest-Sicherheitskoeffizient: 6
- Wärmebehandlung: Normalglühen
- Herstellungsnummer

LABORANALYSEN

- Chemische Analyse
- Metallographische Analyse
- Zerreißprobe

VERFÜGBARE ZERTIFIKATIONEN

- Produktspezifikation
- Abnahmeprüfzeugnis Typ 2.2 UNI EN10204
- Prüfbescheinigung Typ 3.1 UNI EN10204
- CE-Konformitätserklärung

Ø mm	F mm	E mm	WLL kg	€	📦	🚚
* M6	1 11	90	2,10	60	080400306	
M8	1,25 13	140	2,10	60	080400308	
M10	1,5 17	230	2,90	40	080400310	
M12	1,75 20,5	340	3,90	20	080400312	
* M14	2 20,5	480	4,80	20	080400314	
M16	2 27	700	6,00	10	080400316	
* M18	2,5 27	930	7,40	10	080400318	
M20	2,5 30	1200	9,20	10	080400320	
* M22	2,5 30	1450	12,00	10	080400322	
M24	3 36	1800	16,90	5	080400324	
* M27	3 41	2400	21,30	5	080400327	
M30	3,5 45	3200	36,00	2	080400330	
* M33	3,5 54	3900	50,00	2	080400333	
* M33F	2 54	3900	50,00	2	080400334	
M36	4 54	4600	52,50	2	080400336	
* M36F	3 54	4600	52,50	2	080400337	
M42	4,5 63	6300	96,50	1	080400342	
* M42F	3 63	6300	96,50	1	080400343	
M48	5 68	8600	158,00	1	080400348	
* M48F	3 68	8600	158,00	1	080400349	
M56	5,5 78	11500	252,00	1	080400356	
* M56F	4 78	11500	252,00	1	080400357	
M64	6 90	16000	366,00	1	080400364	
* M64F	4 90	16000	366,00	1	080400365	

*Maße gemäß der Technischen Dokumentation Robur

Sonderverpackungen für den freien Service



Ø mm	📦	€	📦	🚚
M6	4	10,00	1	080409506
M8	4	10,00	1	080409508
M10	2	7,30	1	080409510
M12	1	5,30	1	080409312
* M14	1	6,20	1	080409314
M16	1	7,30	1	080409316
* M18	1	8,70	1	080409318
M20	1	10,10	1	080409320
* M22	1	13,80	1	080409322
M24	1	18,50	1	080409324
* M27	1	22,90	1	080409327
M30	1	37,00	1	080409330

8042EZ

Ringmuttern, verzinkt

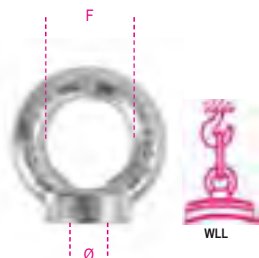

DIN582:2018-04(**)

TECHNISCHE DATEN

- Mindest-Sicherheitskoeffizient: 6
- Wärmebehandlung: Normalglühen
- Herstellungsnummer

LABORANALYSEN

- Chemische Analyse
- Metallographische Analyse
- Zerreißprobe

VERFÜGBARE ZERTIFIKATIONEN

- Produktspezifikation
- Abnahmeprüfzeugnis Typ 2.2 UNI EN10204
- Prüfbescheinigung Typ 3.1 UNI EN10204
- CE-Konformitätserklärung

Ø mm	WLL mm	F mm	WLL kg	€	Stk	Art-Nr
* M6	1	14	90	2,20	60	080420406
M8	1,25	20	140	2,20	60	080420408
M10	1,5	25	230	2,90	40	080420410
M12	1,75	30	340	4,00	30	080420412
* M14	2	30	480	5,10	30	080420414
M16	2	35	700	6,30	20	080420416
* M18	2,5	35	930	7,70	20	080420418
M20	2,5	40	1200	9,60	10	080420420
* M22	2,5	40	1450	12,50	10	080420422
M24	3	50	1800	18,50	5	080420424
* M27	3	55	2400	22,20	5	080420427
M30	3,5	60	3200	36,00	3	080420430
M36	4	70	4600	54,00	2	080420436
* M36F	3	70	4600	54,00	2	080420437
M42	4,5	80	6300	98,50	1	080420442
* M42F	3	80	6300	98,50	1	080420443
M48	5	90	8600	159,00	1	080420448
* M48F	3	90	8600	159,00	1	080420449

*Maße gemäß der Technischen Dokumentation Robur

Spezielle Verpackungen Ringmuttern



Ø mm	WLL mm	Stk	€	Art-Nr
M6	1	20	46,00	1 080420906
M8	1,25	20	46,00	1 080420908
M10	1,5	20	63,00	1 080420910
M12	1,75	15	65,00	1 080420912

Sonderverpackungen für den freien Service



Ø mm	Stk	€	Art-Nr
M6	4	10,30	1 080429606
M8	4	10,30	1 080429608
M10	2	7,40	1 080429610
M12	1	5,50	1 080429412
* M14	1	6,20	1 080429414
M16	1	7,70	1 080429416
* M18	1	8,80	1 080429418
M20	1	10,90	1 080429420
* M22	1	13,80	1 080429422
M24	1	21,30	1 080429424
* M27	1	23,50	1 080429427
M30	1	36,50	1 080429430



8042EN

Ringmuttern, schwarz



DIN582:2018-04(**)

TECHNISCHE DATEN

- Mindest-Sicherheitskoeffizient: 6
- Wärmebehandlung: Normalglühen
- Herstellungsnummer

LABORANALYSE

- Chemische Analyse
- Metallographische Analyse
- Zerreißprobe

VERFÜGBARE ZERTIFIKATIONEN

- Produktspezifikation
- Abnahmeprüfzeugnis Typ 2.2 UNI EN10204
- Prüfbescheinigung Typ 3.1 UNI EN10204
- CE-Konformitätserklärung

Ø mm	WLL mm	F mm	WLL kg	€	Stk	Art-Nr
* M6	1	14	90	2,10	60	080420306
M8	1,25	20	140	2,10	60	080420308
M10	1,5	25	230	2,80	40	080420310
M12	1,75	30	340	3,90	30	080420312
* M14	2	30	480	4,90	30	080420314
M16	2	35	700	5,80	20	080420316
* M18	2,5	35	930	7,30	20	080420318
M20	2,5	40	1200	8,80	10	080420320
* M22	2,5	40	1450	11,80	10	080420322
M24	3	50	1800	16,90	5	080420324
* M27	3	55	2400	20,50	5	080420327
M30	3,5	60	3200	33,00	3	080420330
M36	4	70	4600	50,00	2	080420336
* M36F	3	70	4600	50,00	2	080420337
M42	4,5	80	6300	92,00	1	080420342
* M42F	3	80	6300	92,00	1	080420343
M48	5	90	8600	151,50	1	080420348
* M48F	3	90	8600	151,50	1	080420349

*Maße gemäß der Technischen Dokumentation Robur

Sonderverpackungen für den freien Service



Ø mm	Stk	€	Art-Nr
M6	4	10,00	1 080429506
M8	4	10,00	1 080429508
M10	2	7,30	1 080429510
M12	1	5,10	1 080429312
* M14	1	6,00	1 080429314
M16	1	7,30	1 080429316
* M18	1	8,50	1 080429318
M20	1	10,30	1 080429320
* M22	1	13,50	1 080429322
M24	1	19,20	1 080429324
* M27	1	22,90	1 080429327
M30	1	34,50	1 080429330

8044

Ringmuttern,
schwarz



UNI 2948

TECHNISCHE DATEN

- Mindest-Sicherheitskoeffizient: 4
- Wärmebehandlung: Normalglühen
- Herstellungsnummer

LABORANALYSEN

- chemische Analyse
- metallographische Analyse
- Zerreißprobe

VERFÜGBARE ZERTIFIKATIONEN

- Produktspezifikation
- Abnahmeprüfzeugnis Typ 2.2 UNI EN10204
- Prüfbescheinigung Typ3.1 UNI EN10204
- CE-Konformitätserklärung

Ø mm	WLL mm	WLL kg	€	Stk	Art-Nr
M8	1,25	80	2,80	4	080440008
M10	1,5	160	4,50	4	080440010
M12	1,75	250	7,80	4	080440012
M14	2	250	12,80	2	080440014
M16	2	400	12,80	2	080440016
M20	2,5	630	21,30	2	080440020
M24	3	1000	37,00	2	080440024



WLL Ton UNI EN 818				
Ø mm	WLL 1		WLL 2	
	0° < β ≤ 45°	45° < β ≤ 60°	0° < β ≤ 45°	45° < β ≤ 60°
6	1,12	1,8	1,8	1,12
7	1,5	2,12	2,12	1,5
8	2	2,8	2,8	2
10	3,15	4,25	4,25	3,15
13	5,3	7,5	7,5	5,3
16	8	11,2	11,2	8
Ø mm	WLL 3		WLL 4	
	0° < β ≤ 45°	45° < β ≤ 60°	0° < β ≤ 45°	45° < β ≤ 60°
6	2,38	1,7	1,7	2,38
7	3,15	2,24	2,24	3,15
8	4,25	3	3	4,25
10	6,7	4,75	4,75	6,7
13	11,2	8	8	11,2
16	17	11,2	11,2	17

8091

Bandschlingen, einarmig,
im Koffer

Auf Anfrage mit Self-locking und Verkürzern

CE



UNI EN 818-4

TECHNISCHE DATEN

- Mindest-Sicherheitskoeffizient: 4
 - Serieidentifikationsplatte
- ANLIEGENDE ZERTIFIKATIONEN
- Herstellerzertifikat UNI EN818-4
 - CE-Konformitätserklärung
- VERFÜGBARE ZERTIFIKATIONEN
- Produktspezifikation

D mm	L m	WLL ton	€	U	U
6*	1	1,12	99,50	1	080910001
6*	2	1,12	121,50	1	080910002
6*	3	1,12	144,50	1	080910003
6*	4	1,12	166,50	1	080910004
7*	1	1,5	109,50	1	080910021
7*	2	1,5	138,00	1	080910022
7*	3	1,5	167,00	1	080910023
7*	4	1,5	196,00	1	080910024
8*	1	2	122,00	1	080910041
8*	2	2	155,50	1	080910042
8*	3	2	189,00	1	080910043
8*	4	2	239,50	1	080910044
10*	1	3,15	156,00	1	080910051
10*	2	3,15	207,50	1	080910052
10*	3	3,15	273,00	1	080910053
10*	4	3,15	324,00	1	080910054
13*	1	5,3	252,00	1	080910131
13*	2	5,3	339,00	1	080910132
13*	3	5,3	422,00	1	080910133
13*	4	5,3	508,00	1	080910134
16*	1	8	495,00	1	080910161
16*	2	8	623,00	1	080910162
16*	3	8	753,00	1	080910163
16*	4	8	886,00	1	080910164
20	1	12,5	961,00	1	080910171
20	2	12,5	1.198,00	1	080910172
20	3	12,5	1.435,00	1	080910173
20	4	12,5	1.670,00	1	080910174

* Dem Gewicht entsprechende Holzverpackung

8091SL

Bandschlingen, 1-armig, mit Self-locking
Haken
Güteklasse 8

CE

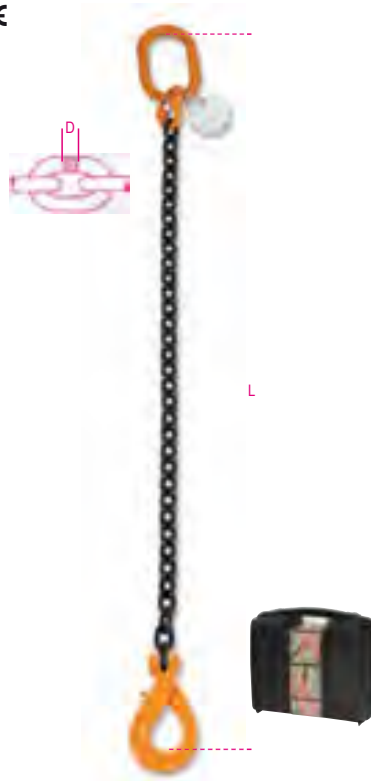

UNI EN 818-4

TECHNISCHE DATEN

- Mindest-Sicherheitskoeffizient: 4
 - Serialidentifikationsplatte
- ANLIEGENDE ZERTIFIKATIONEN
- Herstellerzertifikat UNI EN818-4
 - CE-Konformitätserklärung
- VERFÜGBARE ZERTIFIKATIONEN
- Produktspezifikation

D mm	L m	WLL ton	€	U	U
6*	1	1,12	126,50	1	080910201
6*	2	1,12	148,50	1	080910202
6*	3	1,12	171,00	1	080910203
6*	4	1,12	193,00	1	080910204
7*	1	1,5	144,50	1	080910221
7*	2	1,5	172,50	1	080910222
7*	3	1,5	201,00	1	080910223
7*	4	1,5	230,50	1	080910224
8*	1	2	156,50	1	080910241
8*	2	2	184,00	1	080910242
8*	3	2	223,50	1	080910243
8*	4	2	273,00	1	080910244
10*	1	3,15	196,50	1	080910251
10*	2	3,15	247,00	1	080910252
10*	3	3,15	314,00	1	080910253
10*	4	3,15	381,00	1	080910254
13*	1	5,3	348,00	1	080910331
13*	2	5,3	460,00	1	080910332
13*	3	5,3	520,00	1	080910333
13*	4	5,3	628,00	1	080910334
16*	1	8	654,00	1	080910361
16*	2	8	820,00	1	080910362
16*	3	8	911,00	1	080910363
16*	4	8	1.082,00	1	080910364
20	1	12,5	1.450,00	1	080910401
20	2	12,5	1.685,00	1	080910402
20	3	12,5	1.925,00	1	080910403
20	4	12,5	2.160,00	1	080910404

* Dem Gewicht entsprechende Holzverpackung

8092

Bandschlingen, zweiarmig,
im Koffer

Auf Anfrage mit Self-locking und Verkürzern

CE



EN 818-4

TECHNISCHE DATEN

- Mindest-Sicherheitskoeffizient: 4
 - Serieidentifikationsplatte
- ANLIEGENDE ZERTIFIKATIONEN
- Herstellerzertifikat UNI EN818-4
 - CE-Konformitätserklärung
- VERFÜGBARE ZERTIFIKATIONEN
- Produktspezifikation

D mm	L m	WLL ton	€	U	U
6*	1	1,6	146,50	1	080920001
6*	2	1,6	191,00	1	080920002
6*	3	1,6	236,00	1	080920003
6*	4	1,6	298,00	1	080920004
7*	1	2,12	170,50	1	080920021
7*	2	2,12	229,00	1	080920022
7*	3	2,12	303,00	1	080920023
7*	4	2,12	359,00	1	080920024
8*	1	2,8	193,00	1	080920041
8*	2	2,8	261,00	1	080920042
8*	3	2,8	345,00	1	080920043
8*	4	2,8	413,00	1	080920044
10*	1	4,25	281,00	1	080920051
10*	2	4,25	383,00	1	080920052
10*	3	4,25	480,00	1	080920053
10*	4	4,25	581,00	1	080920054
13*	1	7,5	450,00	1	080920131
13*	2	7,5	618,00	1	080920132
13	3	7,5	767,00	1	080920133
13	4	7,5	995,00	1	080920134
16*	1	11,2	898,00	1	080920161
16	2	11,2	1.192,00	1	080920162
16	3	11,2	1.455,00	1	080920163
16	4	11,2	1.715,00	1	080920164
20	2	17,0	2.185,00	1	080920172
20	3	17,0	2.660,00	1	080920173
20	4	17,0	3.130,00	1	080920174

* Dem Gewicht entsprechende Holzverpackung

Robur

Robur

8092SL

Bandschlingen, 2-armig, mit Self-locking Haken
Güteklasse 8

CE



EN 818-4

TECHNISCHE DATEN

- Mindest-Sicherheitskoeffizient: 4
- Serialidentifikationsplatte
- ANLIEGENDE ZERTIFIKATIONEN
- Herstellerzertifikat UNI EN818-4
- CE-Konformitätserklärung
- VERFÜGBARE ZERTIFIKATIONEN
- Produktspezifikation

D mm	L m	WLL ton	€	📄	📄
6*	1	1,6	201,00	1	080920201
6*	2	1,6	235,00	1	080920202
6*	3	1,6	281,00	1	080920203
6*	4	1,6	349,00	1	080920204
7*	1	2,12	241,00	1	080920221
7*	2	2,12	286,00	1	080920222
7*	3	2,12	373,00	1	080920223
7*	4	2,12	429,00	1	080920224
8*	1	2,8	249,00	1	080920241
8*	2	2,8	332,00	1	080920242
8*	3	2,8	401,00	1	080920243
8*	4	2,8	481,00	1	080920244
10*	1	4,25	395,00	1	080920251
10*	2	4,25	464,00	1	080920252
10*	3	4,25	560,00	1	080920253
10*	4	4,25	693,00	1	080920254
13*	1	7,5	689,00	1	080920331
13*	2	7,5	736,00	1	080920332
13*	3	7,5	1.007,00	1	080920333
13*	4	7,5	1.235,00	1	080920334
16*	1	11,2	1.325,00	1	080920361
16*	2	11,2	1.585,00	1	080920362
16*	3	11,2	1.850,00	1	080920363
16*	4	11,2	2.110,00	1	080920364
20	2	17,0	3.160,00	1	080920402
20	3	17,0	3.640,00	1	080920403
20	4	17,0	4.110,00	1	080920404

* Dem Gewicht entsprechende Holzverpackung

8094

Bandschlingen, vierarmig,
im Koffer

Auf Anfrage mit Self-locking und Verkürzern

CE



EN 818-4

TECHNISCHE DATEN

- Mindest-Sicherheitskoeffizient: 4
- Serieidentifikationsplatte
- ANLIEGENDE ZERTIFIKATIONEN
- Herstellerzertifikat UNI EN818-4
- CE-Konformitätserklärung
- VERFÜGBARE ZERTIFIKATIONEN
- Produktspezifikation

D mm	L m	WLL ton	€	📄	📄
6*	1	2,36	306,00	1	080940001
6*	2	2,36	414,00	1	080940002
6*	3	2,36	503,00	1	080940003
6*	4	2,36	588,00	1	080940004
7*	1	3,15	360,00	1	080940021
7*	2	3,15	475,00	1	080940022
7*	3	3,15	587,00	1	080940023
7*	4	3,15	704,00	1	080940024
8*	1	4,25	432,00	1	080940041
8*	2	4,25	561,00	1	080940042
8*	3	4,25	696,00	1	080940043
8	4	4,25	862,00	1	080940044
10*	1	6,7	573,00	1	080940051
10	2	6,7	784,00	1	080940052
10	3	6,7	1.008,00	1	080940053
10	4	6,7	1.210,00	1	080940054
13	1	11,2	950,00	1	080940131
13	2	11,2	1.295,00	1	080940132
13	3	11,2	1.645,00	1	080940133
13	4	11,2	1.985,00	1	080940134
16	1	17	1.865,00	1	080940161
16	2	17	2.390,00	1	080940162
16	3	17	2.910,00	1	080940163
16	4	17	3.430,00	1	080940164
20	2	26,5	4.160,00	1	080940172
20	3	26,5	5.110,00	1	080940173
20	4	26,5	6.060,00	1	080940174

* Dem Gewicht entsprechende Holzverpackung

Robur

Robur

8094SL

Bandschlingen, 4-armig, mit Self-locking Haken
Güteklasse 8

CE



EN 818-4

TECHNISCHE DATEN

- Mindest-Sicherheitskoeffizient: 4
- Serialidentifikationsplatte
- ANLIEGENDE ZERTIFIKATIONEN
- Herstellerzertifikat UNI EN818-4
- CE-Konformitätserklärung
- VERFÜGBARE ZERTIFIKATIONEN
- Produktspezifikation

D mm	L m	WLL ton	€	📄	📄
6*	1	2,36	412,00	1	080940201
6*	2	2,36	516,00	1	080940202
6*	3	2,36	606,00	1	080940203
6*	4	2,36	693,00	1	080940204
7*	1	3,15	500,00	1	080940221
7*	2	3,15	617,00	1	080940222
7*	3	3,15	726,00	1	080940223
7*	4	3,15	840,00	1	080940224
8*	1	4,25	545,00	1	080940241
8*	2	4,25	675,00	1	080940242
8*	3	4,25	838,00	1	080940243
8	4	4,25	1.003,00	1	080940244
10*	1	6,7	743,00	1	080940251
10	2	6,7	948,00	1	080940252
10	3	6,7	1.180,00	1	080940253
10	4	6,7	1.380,00	1	080940254
13	1	11,2	1.345,00	1	080940331
13	2	11,2	1.685,00	1	080940332
13	3	11,2	2.035,00	1	080940333
13	4	11,2	2.390,00	1	080940334
16	1	17	2.520,00	1	080940361
16	2	17	3.050,00	1	080940362
16	3	17	3.570,00	1	080940363
16	4	17	4.090,00	1	080940364
20	2	26,5	6.290,00	1	080940402
20	3	26,5	7.240,00	1	080940403
20	4	26,5	8.190,00	1	080940404

* Dem Gewicht entsprechende Holzverpackung

8096

Bandschlingen, einarmig,
mit Verkürzern,
im Koffer

CE



EN 818-4

TECHNISCHE DATEN

- Mindest-Sicherheitskoeffizient: 4
- Serieidentifikationsplatte
- ANLIEGENDE ZERTIFIKATIONEN
- Herstellerzertifikat UNI EN818-4
- CE-Konformitätserklärung
- VERFÜGBARE ZERTIFIKATIONEN
- Produktspezifikation

D mm	L m	WLL ton	€		
6*	1	1,12	119,00	1	080960001
6*	2	1,12	142,00	1	080960002
6*	3	1,12	164,00	1	080960003
6*	4	1,12	181,00	1	080960004
7*	1	1,5	131,50	1	080960021
7*	2	1,5	159,50	1	080960022
7*	3	1,5	183,00	1	080960023
7*	4	1,5	211,00	1	080960024
8*	1	2	145,00	1	080960041
8*	2	2	178,00	1	080960042
8*	3	2	212,00	1	080960043
8*	4	2	262,00	1	080960044
10*	1	3,15	201,00	1	080960051
10*	2	3,15	268,00	1	080960052
10*	3	3,15	318,00	1	080960053
10*	4	3,15	370,00	1	080960054
13*	1	5,3	330,00	1	080960131
13*	2	5,3	392,00	1	080960132
13*	3	5,3	474,00	1	080960133
13*	4	5,3	586,00	1	080960134
16*	1	8	651,00	1	080960161
16*	2	8	738,00	1	080960162
16*	3	8	869,00	1	080960163
16	4	8	1.032,00	1	080960164
20	1	12,5	1.250,00	1	080960171
20	2	12,5	1.490,00	1	080960172
20	3	12,5	1.725,00	1	080960173
20	4	12,5	1.965,00	1	080960174

* Dem Gewicht entsprechende Holzverpackung

8096SL

Bandschlingen, 1-armig, mit Self-locking
Haken und Verkürzern
Güteklasse 8

CE



EN 818-4

TECHNISCHE DATEN

- Mindest-Sicherheitskoeffizient: 4
- Serialidentifikationsplatte
- ANLIEGENDE ZERTIFIKATIONEN
- Herstellerzertifikat UNI EN818-4
- CE-Konformitätserklärung
- VERFÜGBARE ZERTIFIKATIONEN
- Produktspezifikation

D mm	L m	WLL ton	€		
6*	1	1,12	140,00	1	080960201
6*	2	1,12	163,00	1	080960202
6*	3	1,12	185,00	1	080960203
6*	4	1,12	208,00	1	080960204
7*	1	1,5	160,00	1	080960221
7*	2	1,5	189,00	1	080960222
7*	3	1,5	219,00	1	080960223
7*	4	1,5	247,00	1	080960224
8*	1	2	174,00	1	080960241
8*	2	2	207,00	1	080960242
8*	3	2	241,00	1	080960243
8*	4	2	290,00	1	080960244
10*	1	3,15	242,00	1	080960251
10*	2	3,15	308,00	1	080960252
10*	3	3,15	359,00	1	080960253
10*	4	3,15	409,00	1	080960254
13*	1	5,3	425,00	1	080960331
13*	2	5,3	511,00	1	080960332
13*	3	5,3	595,00	1	080960333
13*	4	5,3	681,00	1	080960334
16*	1	8	809,00	1	080960361
16*	2	8	936,00	1	080960362
16*	3	8	1.067,00	1	080960363
16	4	8	1.191,00	1	080960364
20	1	12,5	1.785,00	1	080960401
20	2	12,5	2.020,00	1	080960402
20	3	12,5	2.260,00	1	080960403
20	4	12,5	2.495,00	1	080960404

* Dem Gewicht entsprechende Holzverpackung

8097

Bandschlingen, zweiarmig,
mit Verkürzern,
im Koffer

CE



EN 818-4

TECHNISCHE DATEN

- Mindest-Sicherheitskoeffizient: 4
- Serieidentifikationsplatte
- ANLIEGENDE ZERTIFIKATIONEN
- Herstellerzertifikat UNI EN818-4
- CE-Konformitätserklärung
- VERFÜGBARE ZERTIFIKATIONEN
- Produktspezifikation

D mm	L m	WLL ton	€		
6*	1	1,6	184,00	1	080970001
6*	2	1,6	220,00	1	080970002
6*	3	1,6	285,00	1	080970003
6*	4	1,6	326,00	1	080970004
7*	1	2,12	215,00	1	080970021
7*	2	2,12	260,00	1	080970022
7*	3	2,12	335,00	1	080970023
7*	4	2,12	393,00	1	080970024
8*	1	2,8	239,00	1	080970041
8*	2	2,8	309,00	1	080970042
8*	3	2,8	390,00	1	080970043
8*	4	2,8	458,00	1	080970044
10*	1	4,25	373,00	1	080970051
10*	2	4,25	473,00	1	080970052
10*	3	4,25	571,00	1	080970053
10*	4	4,25	671,00	1	080970054
13*	1	7,5	599,00	1	080970131
13*	2	7,5	774,00	1	080970132
13	3	7,5	926,00	1	080970133
13	4	7,5	1.099,00	1	080970134
16	1	11,2	1.160,00	1	080970161
16	2	11,2	1.425,00	1	080970162
16	3	11,2	1.685,00	1	080970163
16	4	11,2	1.955,00	1	080970164
20	2	17,0	2.650,00	1	080970172
20	3	17,0	3.120,00	1	080970173
20	4	17,0	3.600,00	1	080970174

* Dem Gewicht entsprechende Holzverpackung

Robur

Robur

8097SL

Bandschlingen, 2-armig, mit Self-locking Haken und Verkürzern
Güteklasse 8

CE



EN 818-4

TECHNISCHE DATEN

- Mindest-Sicherheitskoeffizient: 4
- Serialidentifikationsplatte
- ANLIEGENDE ZERTIFIKATIONEN
- Herstellerzertifikat UNI EN818-4
- CE-Konformitätserklärung
- VERFÜGBARE ZERTIFIKATIONEN
- Produktspezifikation

D mm	L m	WLL ton	€		
6*	1	1,6	227,00	1	080970201
6*	2	1,6	263,00	1	080970202
6*	3	1,6	316,00	1	080970203
6*	4	1,6	377,00	1	080970204
7*	1	2,12	273,00	1	080970221
7*	2	2,12	334,00	1	080970222
7*	3	2,12	393,00	1	080970223
7*	4	2,12	449,00	1	080970224
8*	1	2,8	294,00	1	080970241
8*	2	2,8	363,00	1	080970242
8*	3	2,8	445,00	1	080970243
8*	4	2,8	512,00	1	080970244
10*	1	4,25	453,00	1	080970251
10*	2	4,25	555,00	1	080970252
10*	3	4,25	651,00	1	080970253
10*	4	4,25	753,00	1	080970254
13*	1	7,5	789,00	1	080970331
13*	2	7,5	962,00	1	080970332
13	3	7,5	1.168,00	1	080970333
13	4	7,5	1.290,00	1	080970334
16	1	11,2	1.565,00	1	080970361
16	2	11,2	1.815,00	1	080970362
16	3	11,2	2.080,00	1	080970363
16	4	11,2	2.260,00	1	080970364
20	2	17,0	3.720,00	1	080970402
20	3	17,0	4.190,00	1	080970403
20	4	17,0	4.660,00	1	080970404

* Dem Gewicht entsprechende Holzverpackung

8098

Bandschlingen, vierarmig, mit Verkürzern, im Koffer

CE



EN 818-4

TECHNISCHE DATEN

- Mindest-Sicherheitskoeffizient: 4
- Serialidentifikationsplatte
- ANLIEGENDE ZERTIFIKATIONEN
- Herstellerzertifikat UNI EN818-4
- CE-Konformitätserklärung
- VERFÜGBARE ZERTIFIKATIONEN
- Produktspezifikation

D mm	L m	WLL ton	€		
6*	1	2,36	380,00	1	080980001
6*	2	2,36	469,00	1	080980002
6*	3	2,36	554,00	1	080980003
6*	4	2,36	644,00	1	080980004
7*	1	3,15	448,00	1	080980021
7*	2	3,15	539,00	1	080980022
7*	3	3,15	651,00	1	080980023
7*	4	3,15	767,00	1	080980024
8*	1	4,25	495,00	1	080980041
8*	2	4,25	625,00	1	080980042
8*	3	4,25	760,00	1	080980043
8	4	4,25	927,00	1	080980044
10*	1	6,7	690,00	1	080980051
10	2	6,7	923,00	1	080980052
10	3	6,7	1.125,00	1	080980053
10	4	6,7	1.325,00	1	080980054
13	1	11,2	1.155,00	1	080980131
13	2	11,2	1.500,00	1	080980132
13	3	11,2	1.860,00	1	080980133
13	4	11,2	2.200,00	1	080980134
16	1	17	2.325,00	1	080980161
16	2	17	2.860,00	1	080980162
16	3	17	3.380,00	1	080980163
16	4	17	3.910,00	1	080980164
20	2	26,5	5.270,00	1	080980172
20	3	26,5	6.220,00	1	080980173
20	4	26,5	7.170,00	1	080980174

* Dem Gewicht entsprechende Holzverpackung

8098SL

Bandschlingen, 4-armig, mit Self-locking Haken und Verkürzern
Güteklasse 8

CE



EN 818-4

TECHNISCHE DATEN

- Mindest-Sicherheitskoeffizient: 4
- Serialidentifikationsplatte
- ANLIEGENDE ZERTIFIKATIONEN
- Herstellerzertifikat UNI EN818-4
- CE-Konformitätserklärung
- VERFÜGBARE ZERTIFIKATIONEN
- Produktspezifikation

D mm	L m	WLL ton	€		
6*	1	2,36	468,00	1	080980201
6*	2	2,36	574,00	1	080980202
6*	3	2,36	641,00	1	080980203
6*	4	2,36	750,00	1	080980204
7*	1	3,15	564,00	1	080980221
7*	2	3,15	655,00	1	080980222
7*	3	3,15	766,00	1	080980223
7*	4	3,15	882,00	1	080980224
8*	1	4,25	637,00	1	080980241
8*	2	4,25	739,00	1	080980242
8	3	4,25	874,00	1	080980243
8*	4	4,25	1.040,00	1	080980244
10*	1	6,7	853,00	1	080980251
10	2	6,7	1.086,00	1	080980252
10	3	6,7	1.290,00	1	080980253
10	4	6,7	1.485,00	1	080980254
13	1	11,2	1.535,00	1	080980331
13	2	11,2	1.875,00	1	080980332
13	3	11,2	2.245,00	1	080980333
13	4	11,2	2.580,00	1	080980334
16	1	17	2.980,00	1	080980361
16	2	17	3.520,00	1	080980362
16	3	17	4.030,00	1	080980363
16	4	17	4.520,00	1	080980364
20	2	26,5	7.410,00	1	080980402
20	3	26,5	8.350,00	1	080980403
20	4	26,5	9.300,00	1	080980404

* Dem Gewicht entsprechende Holzverpackung

Robur

8100

Hochfeste Ketten,
aus legiertem Stahl

CE

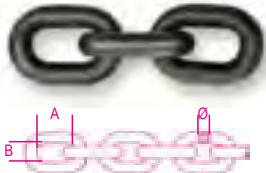

EN 818-2

TECHNISCHE DATEN

- Sicherheitskoeffizient: 4
- Wärmebehandlung: Vergütung
- Herstellungsnummer

LABORANALYSEN

- Chemische Analyse
- Metallographische Analyse
- Zerreißprobe

VERFÜGBARE ZERTIFIKATIONEN

- Produktspezifikation
- Abnahmeprüfzeugnis Typ 2.2 UNI EN10204
- Hersteller-Zertifikat EN818-2
- CE-Konformitätserklärung

WLL kg	Ø mm	A mm	B min mm	€/m	📄	📄
1120	6	18	7,8	22,60	1	081000011
1500	7	21	11,0	29,50	1	081000016
2000	8	24	12,0	34,00	1	081000020
3150	10	30	14,5	51,00	1	081000032
5300	13	39	20,0	87,00	1	081000053
8000	16	48	20,8	133,00	1	081000080
12500	20	60	26,0	237,00	1	081000125

8085R

Aufhängeglieder aus legiertem Stahl, vergütet

CE



EN 1677-4

TECHNISCHE DATEN

- Mindest-Sicherheitskoeffizient: 4
- Wärmebehandlung: Vergütung
- Herstellungsnummer

LABORANALYSEN

- chemische Analyse, metallographische Analyse
- Belastungstest (WLL x 2,5)
- Zerreißprobe
- Ermüdungstest (min. 20.000 Zyklen)

VERFÜGBARE ZERTIFIKATIONEN

- Produktspezifikation
- Abnahmeprüfzeugnis Typ 2.2 UNI EN10204
- Prüfbescheinigung Typ 3.1 UNI EN10204
- CE-Konformitätserklärung

WLL kg	Ø mm	A mm	B mm	€	📄	📄
* 1600	7	110	60	12,00	1	080850215
2120	8	110	60	17,00	1	080850220
3150	10	135	75	24,10	1	080850232
5300	13	160	90	42,50	1	080850253
8000	16	180	100	84,50	1	080850280
11200	19	200	110	137,00	1	080850311
16000	20	260	140	225,00	1	080850316
17000	22	300	160	319,00	1	080850317

Die Arbeitsbelastung bezieht sich auf die Verwendung mit Schlingen mit 1 Arm.

(*) Kombiniert mit Ø 6 Kette, WLL= 1120 kg.

8086

Aufhängegarnituren aus legiertem Stahl,
vergütet

CE



EN 1677-4

TECHNISCHE DATEN

- Mindest-Sicherheitskoeffizient: 4
- Wärmebehandlung: Vergütung
- Herstellungsnummer

LABORANALYSEN

- chemische Analyse metallographische Analyse
- Belastungstest (WLL x 2,5)
- Zerreißprobe
- Ermüdungstest (Min. 20.000 Zyklen)

VERFÜGBARE ZERTIFIKATIONEN

- Produktspezifikation
- Abnahmeprüfzeugnis Typ 2.2 UNI EN10204
- Prüfbescheinigung Typ3.1 UNI EN10204
- CE-Konformitätserklärung

WLL kg	Ø mm	B mm	C mm	€	📄	📄
* 3150	7	135	75	77,50	1	080860021
4250	8	160	90	119,50	1	080860042
6700	10	180	100	153,50	1	080860067
11200	13	200	110	249,00	1	080860100
17000	16	260	140	364,00	1	080860117
21200	18	340	180	651,00	1	080860121
26500	20	350	190	924,00	1	080860126

Die Arbeitslast bezieht sich auf 3 oder 4 Arme und einen Winkel B von weniger als 45°.

(*) In Kombination mit Kette Ø 6 mm, WLL= 2360 kg

8090R

Verbindungsglieder aus legiertem Stahl,
vergütet

CE

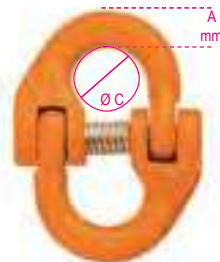

EN 1677-1

TECHNISCHE DATEN

- Mindest-Sicherheitskoeffizient: 4
- Wärmebehandlung: Vergütung
- Herstellungsnummer

LABORANALYSEN

- chemische Analyse, metallographische Analyse
- Belastungstest (WLL x 2,5)
- Zerreißprobe
- Ermüdungstest (Min. 20.000 Zyklen)

VERFÜGBARE ZERTIFIKATIONEN

- Produktspezifikation
- Abnahmeprüfzeugnis Typ 2.2 UNI EN10204
- Prüfbescheinigung Typ3.1 UNI EN10204
- CE-Konformitätserklärung

WLL kg	Ø mm	Ø C max mm	A mm	€	📄	📄
1120	6	13	7,5	10,20	1	080900111
1500	7	18	9	13,20	1	080900115
2000	8	18	11	16,10	1	080900120
3150	10	22	13,0	19,70	1	080900131
5300	13	30	16	36,00	1	080900153
8000	16	32	22	77,50	1	080900180
12500	20	40	25	177,50	1	080900312

8060R

Haken Clevis aus legiertem Stahl, vergütet

CE



EN 1677-2

TECHNISCHE DATEN

- Sicherheitskoeffizient: 4
- Wärmebehandlung: Vergütung
- Herstellungsnummer auf Bolzen, Lasche, Gehäuse

LABORANALYSEN

- chemische Analyse, metallographische Analyse
- Belastungstest (WLL x 2,5)
- Zerreißprobe
- Ermüdungstest (min. 20.000 Zyklen)

VERFÜGBARE ZERTIFIKATIONEN

- Produktspezifikation
- Abnahmeprüfzeugnis Typ 2.2 UNI EN10204
- Prüfbescheinigung Typ 3.1 UNI EN10204
- CE-Konformitätserklärung

WLL kg	Ø mm	C mm	€	📄	📄
1120	6	19	19,20	1	080600111
1500	7	19	20,50	1	080600115
2000	8	21	21,40	1	080600120
3150	10	27	37,00	1	080600132
5300	13	35	58,50	1	080600153
8000	16	48	186,50	1	080600180
12500	20	54	332,00	1	080600225

8058R

Haken Self-Locking Clevis,
aus hochfestem legiertem Stahl

CE



EN 1677-3

TECHNISCHE DATEN

- Mindest-Sicherheitskoeffizient: 4
- Wärmebehandlung: Vergütung
- Herstellungsnummer

LABORANALYSEN

- chemische Analyse, metallographische Analyse
- Zerreißprobe
- Ermüdungstest (min. 20.000 Zyklen)
- Probelastungstest (100% der Partie)

VERFÜGBARE ZERTIFIKATIONEN

- Produktspezifikation
- Abnahmeprüfzeugnis Typ 2.2 UNI EN10204
- Prüfbescheinigung 3.1 UNI EN10204
- CE-Konformitätserklärung

WLL kg	Ø mm	J min mm	€	📄	📄
1120	6	28	41,00	1	080580112
2000	7-8	34	50,00	1	080580120
3150	10	44	77,50	1	080580132
5300	13	52	153,50	1	080580153
8000	16	67	346,00	1	080580180
12500	20	77	864,00	1	080580225

8061R

Verkürzungshaken mit Gabel mit Sicherheitssperre, aus hochfestem legiertem Stahl

CE



EN 1677-1

TECHNISCHE DATEN

- Mindest-Sicherheitskoeffizient: 4
- Wärmebehandlung: Vergütung
- Herstellungsnummer

LABORANALYSEN

- chemische Analyse, metallographische Analyse
- Zerreißprobe

- Ermüdungstest (min. 20.000 Zyklen)
- Probelastungstest (100% der Partie)

VERFÜGBARE ZERTIFIKATIONEN

- Produktspezifikation
- Abnahmeprüfzeugnis Typ 2.2 UNI EN10204
- Prüfbescheinigung Typ 3.1 UNI EN10204
- CE-Konformitätserklärung

WLL	Ø	E	€	📄	📄
kg	mm	mm			
1120	6	8	14,20	1	080610211
2000	7-8	11	16,30	1	080610220
3150	10	13	29,50	1	080610231
5300	13	17	52,00	1	080610253
8000	16	20	116,50	1	080610280
12500	20	24	278,00	1	080610312

8052

Hochfeste Ösenhaken für Seil, legierter Stahl, vergütet

CE



EN 1677-2

TECHNISCHE DATEN

- Sicherheitskoeffizient: 4
- Wärmebehandlung: Vergütung
- Herstellungsnummer

LABORANALYSEN

- chemische Analyse, metallographische Analyse
- Zerreißprobe

- Ermüdungstest (min. 20.000 Zyklen)
- Probelastungstest (2 x WLL)

VERFÜGBARE ZERTIFIKATIONEN

- Produktspezifikation
- Abnahmeprüfzeugnis Typ 2.2 UNI EN10204
- Prüfbescheinigung Typ 3.1 UNI EN10204
- CE-Konformitätserklärung

WLL	C	€	📄	📄
kg	mm			
8052 0,8	800 18	7,40	1	080520008
8052 1,12	1120 22,5	9,80	1	080520011
8052 2	2000 30	20,60	1	080520020
8052 3,15	3150 36	32,00	1	080520031
8052 4	4000 39,5	41,00	1	080520040

8055S 5,4	5400 32	79,50	1	080550145
8055S 8,0	8000 43	138,50	1	080550170
8055S 11,5	11500 53	276,00	1	080550215
8055S 16,0	16000 58	371,00	1	080550260
8055S 22,0	22000 78	869,00	1	080550320

8057R

Haken Self-Locking mit Öse, aus hochfestem legiertem Stahl

CE



EN 1677-3

TECHNISCHE DATEN

- Mindest-Sicherheitskoeffizient: 4
- Wärmebehandlung: Vergütung
- Herstellungsnummer

LABORANALYSEN

- chemische Analyse, metallographische Analyse
- Zerreißprobe

- Ermüdungstest (min. 20.000 Zyklen)
- Probelastungstest (100% der Partie)

VERFÜGBARE ZERTIFIKATIONEN

- Produktspezifikation
- Abnahmeprüfzeugnis Typ 2.2 UNI EN10204
- Prüfbescheinigung Typ 3.1 UNI EN10204
- CE-Konformitätserklärung

WLL	Ø	J min	ØB	€	📄	📄
kg	mm	mm	mm			
1120	6	28	22	33,00	1	080570112
2000	7-8	34	25	39,00	1	080570120
3150	10	44	32	70,50	1	080570132
5300	13	54	40	245,50	1	080570153

8063

Hebehaken, ausricht- und schwenkbar (nicht unter Belastung) aus hochfestem legiertem Stahl

CE

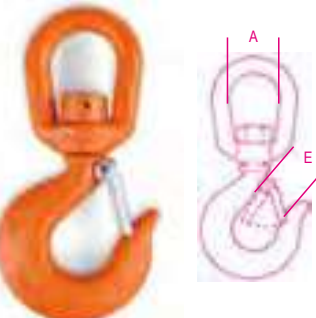

EN 1677-1

TECHNISCHE DATEN

- Mindest-Sicherheitskoeffizient: 4
- Wärmebehandlung: Vergütung
- Herstellungsnummer

LABORANALYSEN

- chemische Analyse, metallographische Analyse
- Zerreißprobe

- Ermüdungstest (min. 20.000 Zyklen)
- Probelastungstest (100% der Partie)

VERFÜGBARE ZERTIFIKATIONEN

- Produktspezifikation
- Abnahmeprüfzeugnis Typ 2.2 UNI EN10204
- Prüfbescheinigung Typ 3.1 UNI EN10204
- CE-Konformitätserklärung

WLL	A	E	€	📄	📄
kg	mm	mm			
800	32	20,5	16,30	1	080630008
1120	38	20,5	20,50	1	080630011
2000	44,5	22	25,00	1	080630020
3150	44,5	27	31,00	1	080630031

8063SL

Selbstsichernde Haken, ausricht- und schwenkbar (nicht unter Belastung), aus hochfestem legiertem Stahl, Güteklasse 8

CE



EN 1677-1

TECHNISCHE DATEN

- Mindest-Sicherheitskoeffizient: 4
- Wärmebehandlung: Vergütung
- Herstellungsnummer

LABORANALYSEN

- chemische Analyse, metallographische Analyse
- Zerreißprobe

- Ermüdungstest (min. 20.000 Zyklen)
- Prüflast (100% der Partie)

VERFÜGBARE ZERTIFIKATIONEN

- Produktspezifikation
- Abnahmeprüfzeugnis Typ 2.2 UNI EN10204
- Prüfbescheinigung Typ 3.1 UNI EN10204
- CE-Konformitätserklärung

WLL	Ø	B	J	€	📄	📄
kg	mm	mm	mm			
1120	6	32	45	43,00	1	080630311
2000	8	35	59	59,00	1	080630320
3150	10	42	54	103,00	1	080630331
5300	13	49	83	157,00	1	080630353

8064S

Lasthaken aus Kohlenstoffstahl, vergütet

CE



EN 1677-5

TECHNISCHE DATEN

- Mindest-Sicherheitskoeffizient: 5
- Wärmebehandlung: Vergütung
- Herstellungsnummer

LABORANALYSEN

- chemische Analyse, metallographische Analyse
- Belastungstest (WLL x 2,5)
- Zerreißprobe

- Ermüdungstest (Min. 20.000 Zyklen)

VERFÜGBARE ZERTIFIKATIONEN

- Produktspezifikation
- Abnahmeprüfzeugnis Typ 2.2 UNI EN10204
- Prüfbescheinigung Typ 3.1 UNI EN10204
- CE-Konformitätserklärung

WLL	B	C	€	📄	📄
kg	mm	mm			
800	31	20	39,50	1	080640107
1000	40	22	56,00	1	080640110
1600	47	23	73,00	1	080640115
2000	47	27	80,00	1	080640120
3200	64	35	139,50	1	080640130
5000	77	43	255,00	1	080640150
7500	90	53	372,00	1	080640175
10000	96	58	618,00	1	080640199

8065SC

Lastdrehhaken aus Kohlenstoffstahl

CE

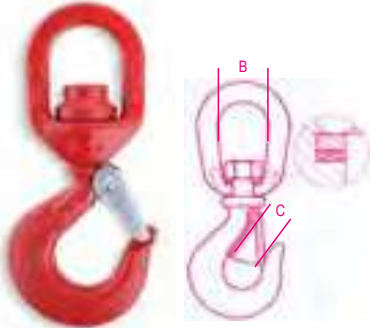

EN 1677-5

TECHNISCHE DATEN

- Mindest-Sicherheitskoeffizient: 5
- Wärmebehandlung: Vergütung
- Herstellungsnummer
- LABORANALYSEN
- chemische Analyse, metallographische Analyse
- Belastungstest (WLL x 2,5)
- Zerreißprobe
- Ermüdungstest (Min. 20.000 Zyklen)
- VERFÜGBARE ZERTIFIKATIONEN
- Produktspezifikation
- Abnahmeprüfzeugnis Typ 2.2 UNI EN10204
- Prüfbescheinigung Typ3.1 UNI EN10204
- CE-Konformitätserklärung

WLL kg	B mm	C mm	€	📦	🚚
800	38	20	79,50	1	080650107
1000	38	22	86,50	1	080650110
1600	47	23	107,50	1	080650115
2000	47	27	122,50	1	080650120
3200	54	35	215,00	1	080650130
5000	72	43	318,00	1	080650150
7500	82	53	539,00	1	080650175

8062

Gleithaken aus legiertem Stahl

CE



TECHNISCHE DATEN

- Mindest-Sicherheitskoeffizient: 5
- Wärmebehandlung: Vergütung
- Herstellungsnummer
- LABORANALYSEN
- chemische Analyse, metallographische Analyse
- Belastungstest (WLL x 2,5)
- Zerreißprobe
- VERFÜGBARE ZERTIFIKATIONEN
- Produktspezifikation
- Abnahmeprüfzeugnis Typ 2.2 UNI EN10204
- Prüfbescheinigung Typ3.1 UNI EN10204
- CE-Konformitätserklärung

WLL kg	C mm	F mm	€	📦	🚚
1500	19	10-13	48,00	1	080620013
2000	21	16	67,50	1	080620016
3000	26	18	113,00	1	080620018

8051S

Ösenhaken mit Sicherheitssperre, geschmiedet, verzinkt

CE



TECHNISCHE DATEN

- Mindest-Sicherheitskoeffizient: 4
- Wärmebehandlung: Normalglühen
- Herstellungsnummer

LABORANALYSEN

- chemische Analyse
- metallographische Analyse
- Zerreißprobe

VERFÜGBARE ZERTIFIKATIONEN

- Produktspezifikation
- Abnahmeprüfzeugnis Typ 2.2 UNI EN10204
- Prüfbescheinigung Typ3.1 UNI EN10204
- CE-Konformitätserklärung

WLL kg	C mm	F mm	€	📦	🚚
250	14	12	3,60	10	080510202
500	18	16,5	7,80	5	080510205

Sonderverpackungen für den freien Service



WLL kg	📦	€	🚚	🚚
250	1	5,10	1	080519202
500	1	9,70	1	080519205

8134

Permanent-Lasthebemagnete

CE



EN13155

Technische Daten:

- Sicherheitskoeffizient: 3
- Serienidentifikationsplatte

Verfügbare Zertifikationen:

- Herstellerzertifikat
- Konformitätserklärung DM2006/42/EG
- Abnahmeprüfzeugnis Typ 2.2 UNI EN10204
- Bedienungs- und Wartungsanleitung

WLL kg	A mm	B mm	C mm	€	📦	🚚
100	70	64	92	510,00	1	081340010
300	96	88	165	896,00	1	081340030
600	120	118	236	1.665,00	1	081340060
1000	168	168	264	2.750,00	1	081340100

8135

Hebezeugen für Bleche mit Aufhängering mit Gelenk

CE



EN13155

TECHNISCHE DATEN

- Mindest-Sicherheitskoeffizient: 3
- Kennplakette mit Seriennummer
- VERFÜGBARE ZERTIFIKATIONEN
- Herstellerzertifikat
- CE-Konformitätserklärung
- Abnahmeprüfzeugnis Typ 2.2 UNI EN10204
- Produktspezifikation

WLL t	A mm	E mm	kg	€	📦	🚚
0,75	0-15	2	2	147,00	1	081350005
1,0	0-20	5	5	197,00	1	081350010
2,0	0-25	8	8	293,00	1	081350020
3,0	0-30	15	15	495,00	1	081350032
5,0	0-50	23	23	697,00	1	081350050

8143

Handkettenzüge

CE



EN13157

Certificato TÜV

WLL t	📦 L m	sforzo / effort kg	€	📦	🚚
0,5	3	27	236,00	1	081430005
1	3	44	277,00	1	081430010
1,5	3	44	369,00	1	081430015
2	3	44	402,00	1	081430020
3	3	45	518,00	1	081430030
5	3	47	770,00	1	081430050

0,5	6	27	351,00	1	081430105
1	6	44	394,00	1	081430110
1,5	6	44	516,00	1	081430115
2	6	44	557,00	1	081430120
3	6	45	797,00	1	081430130
5	6	47	1.129,00	1	081430150

8146

Hebelzüge

CE



EN13157
Certificato TUV

8146C

Kompakte Hebelzüge

CE



EN13157
Certificato TUV

WLL	t	L	m	sforzo / effort	kg	€	📄	📱
0,25	1,5	20,7		264,00		1	081460002	

H= Mindestabstand zwischen den Haken

8147C

Fahrwerke mit Kettenantrieb für manuelle Hebezeuge

Geeignet für Stahlträger wie INP, IPB, IPE, HEA, HEB

CE



EN 13157

Technische Daten:
• Sicherheitsfaktor: 4
• Identifikationsplatte mit Seriennummer

Verfügbare Zertifikationen:
• Herstellerzertifikat
• CE-Konformitätserklärung
• Abnahmeprüfzeugnis Typ 2.2 UNI EN10204
• Produktspezifikation

WLL	t	L min	L max	Lm	€	📄	📱
1,0	58	220	3	294,00	1	081470510	
2,0	66	220	3	378,00	1	081470520	
3,0	74	220	3	577,00	1	081470530	
5,0	90	220	3	797,00	1	081470550	

Der Artikel wird in zerlegtem Zustand geliefert. Er muss vor dem Gebrauch anhand der Gebrauchsanweisung zusammengebaut werden.

8147S

Schiebefahrwerke für manuelle Hebezeuge

Geeignet für Stahlträger wie INP, IPB, IPE, HEA, HEB

CE



EN 13157

Technische Daten:
• Sicherheitsfaktor: 4
• Identifikationsplatte mit Seriennummer

Verfügbare Zertifikationen:
• Herstellerzertifikat
• CE-Konformitätserklärung
• Abnahmeprüfzeugnis Typ 2.2 UNI EN10204
• Produktspezifikation

WLL	t	L min	L max	øF	mm	€	📄	📱
0,5	50	220	25	190,00	1	081470005		
1,0	58	220	30	243,00	1	081470010		
2,0	66	220	40	310,00	1	081470020		

Der Artikel wird in zerlegtem Zustand geliefert. Er muss vor dem Gebrauch anhand der Gebrauchsanweisung zusammengebaut werden.

8147P

Ankerzangen für manuelle Hebezeuge

Geeignet für Stahlträger wie INP, IPB, IPE, HEA, HEB

CE

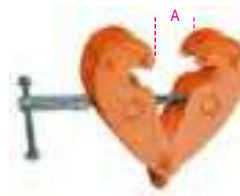

Technische Daten:
• Sicherheitsfaktor: 4
• Identifikationsplatte mit Seriennummer

Verfügbare Zertifikationen:
• Herstellerzertifikat
• CE-Konformitätserklärung
• Abnahmeprüfzeugnis Typ 2.2 UNI EN10204
• Produktspezifikation

WLL	t	A min	A max	mm	€	📄	📱
1,0	90	180	125,50	1	081470210		
2,0	90	190	151,50	1	081470220		
3,0	85	280	256,00	1	081470230		
5,0	85	280	373,00	1	081470250		

Robur

Robur

8148

Handseilwinde, Korpus in Aluminiumlegierung, komplett mit Betätigungshebel, Seil und Haken

Die leichte und tragbare Handseilwinde Robur entspricht der Norm EN 13157. Sie ist aus hochqualitativen Materialien gefertigt und für das Heben, Ziehen, Spannen und Befestigen von Lasten in allen Richtungen über den Betätigungshebel geeignet.

Die Seilwinde wird im Allgemeinen mittels einer Verbindung mit einem festen Verankerungspunkt benutzt und ermöglicht eine hohe Genauigkeit der Positionierung der Last und garantiert einen sicheren Betrieb in allen Richtungen: horizontal, vertikal oder schräg. Dank ihres kompakten und handlichen Designs ist sie leicht zu installieren und zu bedienen.

Die Handseilwinde Robur ermöglicht die Verwendung von Seilen ohne Längeneinschränkung und nach vorausgehender Prüfung der Stützstruktur kann die Tragfähigkeit durch die Verwendung von Umlenkrollen und Haken mit Unterflasche in Übereinstimmung mit der Referenznorm um einen Faktor von 2, 3, 4 oder mehr erhöht werden.

CE



EN 13157

• Sicherheitsfaktor: 4:1

WLL t	L m	A mm	øf mm	€	U	W
0,8	20	426	8,3	433,00	1	081480008
1,6	20	545	11	677,00	1	081480016
3,2	20	660	16	1.114,00	1	081480032

0,8	30	426	8,3	472,00	1	081480108
1,6	30	545	11	738,00	1	081480116
3,2	30	660	16	1.230,00	1	081480132

0,8	50	426	8,3	570,00	1	081480308
1,6	50	545	11	855,00	1	081480316
3,2	50	660	16	1.485,00	1	081480332

8148F

Verzinktes Stahllitzenseil auf Haspel mit hochbelastbarem Haken

CE



WLL t	L m	ØF	€	U	W
0,8	20	8,3	115,50	1	081480520
1,6	20	11	182,50	1	081480521
3,2	20	16	353,00	1	081480523

0,8	30	8,3	163,50	1	081480530
1,6	30	11	255,00	1	081480531
3,2	30	16	489,00	1	081480533

0,8	50	8,3	261,00	1	081480550
1,6	50	11	372,00	1	081480551
3,2	50	16	749,00	1	081480553

8120

Ketten Typ "Genovese" für statische Verbindungen, verzinkt



TECHNISCHE DATEN

- Mindest-Sicherheitskoeffizient: 4
- VERFÜGBARE ZERTIFIKATIONEN
- Produktspezifikation
- Abnahmeprüfzeugnis Typ 2.2 UNI EN10204

Ø mm	nr	WFL kg	m	€	U	W
1,5	10	8	150	220,00	1	081200015
1,6	12	15	150	229,00	1	081200016
2,2	14	25	75	134,00	1	081200022
2,7	16	40	75	166,00	1	081200027
3,0	17	55	75	183,00	1	081200030
3,4	18	100	60	186,50	1	081200034
3,8	19	110	50	180,50	1	081200038
4,4	20	200	40	167,00	1	081200044
4,8	21	250	30	159,00	1	081200048
5,5	22	300	25	159,00	1	081200055
5,8	23	310	25	180,50	1	081200058
6,5	24	400	25	204,50	1	081200065
7,0	25	450	25	249,00	1	081200070
7,5	26	550	20	222,50	1	081200075
* 8,0	27	600	25	322,00	1	081200080
* 9,0	28	800	25	404,00	1	081200090
* 10,0	30	1000	20	409,00	1	081200100
* 12,0	32	1400	15	433,00	1	081200120

Achtung: Dieses Produkt ist NICHT zum Heben bestimmt

(*) GEWICKELT

8120B

Ketten Typ "Genovese" für statische Verbindungen, verzinkt



TECHNISCHE DATEN

- Mindest-Sicherheitskoeffizient: 4
- VERFÜGBARE ZERTIFIKATIONEN
- Produktspezifikation
- Abnahmeprüfzeugnis Typ 2.2 UNI EN10204

Ø mm	nr	WFL kg	m	€	U	W
1,5	10	8	200	274,00	1	081200315
1,6	12	15	200	289,00	1	081200316
2,2	14	25	100	171,00	1	081200322
2,7	16	40	100	219,00	1	081200327
3,0	17	55	75	182,50	1	081200330
3,4	18	100	100	290,00	1	081200334
3,8	19	110	75	257,00	1	081200338
4,4	20	200	50	199,50	1	081200344
4,8	21	250	50	257,00	1	081200348
5,5	22	300	40	247,00	1	081200355
5,8	23	310	30	211,00	1	081200358
6,5	24	400	30	240,50	1	081200365
7,0	25	450	25	243,00	1	081200370
7,5	26	550	25	268,00	1	081200375
8,0	27	600	15	206,50	1	081200380
9,0	28	800	15	244,00	1	081200390
10,0	30	1000	10	200,00	1	081200400
12,0	32	1400	8	231,00	1	081200420

Achtung: NICHT zum Heben geeignet

8121MZC

Ketten Typ "Genovese" für statische Verbindungen, feuerverzinkt



VERFÜGBARE ZERTIFIKATIONEN

- Produktspezifikation
- Abnahmeprüfzeugnis Typ 2.2 UNI EN10204

Ø mm	nr	WFL kg	m	€	U	W
6,0	23	310	50	394,00	1	081210306
8,0	27	600	50	673,00	1	081210308
10,0	30	1000	50	1.065,00	1	081210310
12,0	32	1400	50	1.530,00	1	081210312
14,0	34	1800	50	2.150,00	1	081210314

8120D

Kalibrierte Ketten nach DIN766, galvanisch verzinkt

Auf Anfrage in der gewünschten Länge erhältlich (>30m)



TECHNISCHE DATEN

- Mindest-Sicherheitskoeffizient: 4
- VERFÜGBARE ZERTIFIKATIONEN
- Produktspezifikation
- Abnahmeprüfzeugnis Typ 2.2 UNI EN10204

Ø mm	P	WFL kg	m	€	U	W
4	16	200	30	137,50	1	081200640
5	18,5	320	30	194,00	1	081200650
6	18,5	400	30	294,00	1	081200660
7	22	630	30	353,00	1	081200670
8	24	800	30	467,00	1	081200680
10	28	1250	30	712,00	1	081200700

Kalibrierte Ketten nach DIN766, feuerverzinkt

Ø mm	P	WFL kg	m	€	U	W
4	16	200	30	171,00	1	081200840
5	18,5	320	30	234,00	1	081200850
6	18,5	400	30	347,00	1	081200860
7	22	630	30	408,00	1	081200870
8	24	800	30	542,00	1	081200880
10	28	1250	30	820,00	1	081200900

8129

Abgrenzungskette
aus verzinktem Metall, weiß/rot lackiert



Ø mm	m	€	📦	🖨️
5	30	290,00	1	081290050

Achtung: Das Produkt ist NICHT zum Heben oder Verankern bestimmt

8130

Diebstahlschutzketten aus legiertem Stahl,
gesintert und vergütet,
verzinkt



Ø mm	L mm	€	📦	🖨️
6	800	17,60	1	081300068
8	1000	38,00	1	081300081
8	1200	43,00	1	081300082
10	1500	66,00	1	081300105

8074

Karabinerhaken,
verzinkt



DIN 5299 tipo C

TECHNISCHE DATEN

- Mindest-Sicherheitskoeffizient: 4
- VERFÜGBARE ZERTIFIKATIONEN
- Produktspezifikation
- Abnahmeprüfzeugnis Typ 2.2 UNI EN10204

DxL mm	A mm	WFL kg	€	📦	🖨️
4x40	6	20	0,90	100	080740040
5x50	7	30	0,90	100	080740050
6x60	8	40	0,82	100	080740060
7x70	9	60	1,10	50	080740070
8x80	11	75	1,30	50	080740080
9x90	12	100	1,80	25	080740090
10x100	13	120	2,40	25	080740100
11x120	16	140	3,20	20	080740101
12x140	22	140	4,40	15	080740102
13x160	24	200	6,00	10	080740103
14x180	32	250	12,50	5	080740104

Spezielle Verpackungen Karabinerhaken



DxL mm	A mm	📦	€	📦	🖨️
6x60	8	50	46,00	1	080740760
7x70	9	25	30,00	1	080740770
8x80	11	25	35,00	1	080740780
9x90	12	15	29,00	1	080740790
10x100	13	15	39,00	1	080740800
11x120	16	10	35,00	1	080740801
12x140	22	10	49,00	1	080740802

8074A

Karabinerhaken mit Ring,
verzinkt

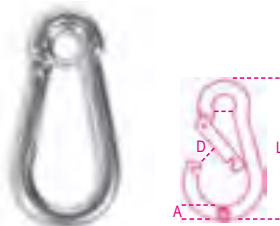

DIN 5299 tipo A

TECHNISCHE DATEN

- Mindest-Sicherheitskoeffizient: 4
- VERFÜGBARE ZERTIFIKATIONEN
- Produktspezifikation
- Abnahmeprüfzeugnis Typ 2.2 UNI EN10204

øAxL mm	D mm	WFL kg	€	📦	🖨️
5x50	7,4	30	1,10	50	080740405
6x60	8,7	40	1,30	50	080740406
8x80	10,5	75	1,70	25	080740408
10x100	13,3	120	2,80	10	080740410

8074G

Karabinerhaken mit Nutmutter,
verzinkt



TECHNISCHE DATEN

- Mindest-Sicherheitskoeffizient: 4
- VERFÜGBARE ZERTIFIKATIONEN
- Produktspezifikation
- Abnahmeprüfzeugnis Typ 2.2 UNI EN10204

øAxL mm	D mm	WFL kg	€	📦	🖨️
5x50	7,5	30	1,20	50	080740305
6x60	8,5	40	1,30	50	080740306
8x80	10,3	75	1,80	25	080740308
10x100	10,6	120	2,90	10	080740310

8080

Kettenschlösser,
verzinkt



TECHNISCHE DATEN

- Mindest-Sicherheitskoeffizient: 4
- VERFÜGBARE ZERTIFIKATIONEN
- Produktspezifikation
- Abnahmeprüfzeugnis Typ 2.2 UNI EN10204

DxL mm	A mm	WFL kg	€	📦	🖨️
3,5x36	5	20	0,70	100	080800003
4x40	6	30	0,70	100	080800004
5x49	6	50	0,90	100	080800005
6x57	8	60	1,10	100	080800006
7x66	8	100	1,30	50	080800007
8x74	11	140	1,60	50	080800008
9x80	11	160	2,20	25	080800009
10x89	11	220	2,60	25	080800010
12x105	15	300	4,40	20	080800012
14x122	16,5	400	9,40	3	080800014

8080FM

Kettenschlösser,
verzinkt

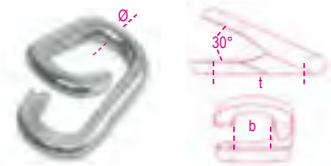

TECHNISCHE DATEN

- Mindest-Sicherheitskoeffizient: 4
- VERFÜGBARE ZERTIFIKATIONEN
- Produktspezifikation
- Abnahmeprüfzeugnis Typ 2.2 UNI EN10204

M	ød mm	b mm	t mm	€	📦	🖨️
4	3,8	8,6	21,5	0,60	100	080800204
5	4,7	11,1	25,8	0,90	50	080800205
6	5,3	13,8	32,0	1,60	30	080800206
7	6,5	16,8	37,0	1,80	10	080800207
8	8,0	18,0	38,0	2,70	10	080800208

8082

Ringe
aus verzinktem Stahl

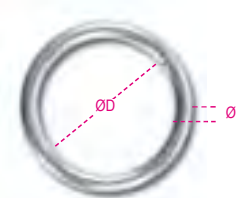

Ø mm	ØD mm	WFL kg	€	📦	🖨️
4	20	75	0,60	50	080820004
5	30	125	0,70	20	080820005
6	40	185	1,10	10	080820006
7	50	265	1,60	5	080820007
8	60	350	2,10	5	080820008

8083

S-Haken
aus verzinktem Stahl



Ø mm	L mm	WFL kg	€	📦	🚚
3	33	4	0,20	100	080830003
4	40	5	0,23	60	080830004
5	47	12	0,40	50	080830005
6	59	18	0,60	30	080830006
8	79	33	1,30	10	080830008

8114

Wirbel,
verzinkt,
Type Marche

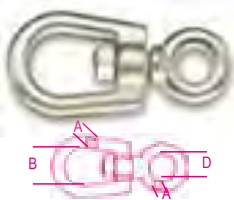

TECHNISCHE DATEN

- Mindest-Sicherheitskoeffizient: 4
- Identifizierungscode

LABORANALYSEN

- Zerreißprobe

VERFÜGBARE ZERTIFIKATIONEN

- Produktspezifikation
- Abnahmeprüfzeugnis 2.2 UNI EN10204
- Prüfbescheinigung Typ 3.1 UNI EN10204

A mm	B mm	D mm	WFL kg	€	📦	🚚
8	30	16	250	4,80	10	081140008
10	38	18	300	8,70	10	081140010
12	42	20	650	12,70	5	081140012
14	48	22	820	19,50	5	081140014
16	57	24	1000	26,50	3	081140016
18	64	26	1600	32,00	3	081140018
20	72	30	2000	45,00	1	081140020
22	80	34	2500	62,50	1	081140022

8116

Wirbel,
verzinkt,
type Sicilia

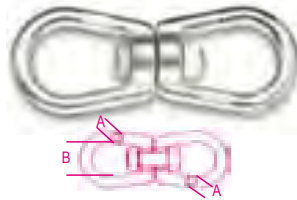

TECHNISCHE DATEN

- Mindest-Sicherheitskoeffizient: 4
- Identifizierungscode

LABORANALYSEN

- Zerreißprobe

VERFÜGBARE ZERTIFIKATIONEN

- Produktspezifikation
- Abnahmeprüfzeugnis Typ 2.2 UNI EN10204
- Prüfbescheinigung Typ 3.1 UNI EN10204

A mm	B mm	WFL kg	€	📦	🚚
6	23	140	5,10	10	081160006
8	30	250	6,30	10	081160008
10	38	300	11,50	5	081160010
12	42	650	18,80	5	081160012
14	48	820	28,00	3	081160014
16	57	1000	35,50	3	081160016
18	64	1600	42,50	1	081160018
20	72	2000	60,50	1	081160020
22	80	2500	93,50	1	081160022

8317SZ

Einfache Drahtseilklemmen, verzinkt

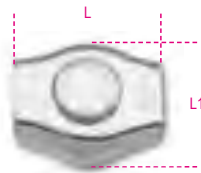

VERFÜGBARE ZERTIFIKATIONEN

- Abnahmeprüfzeugnis Typ 2.2 UNI EN10204

Ø mm	L mm	L1 mm	€	📦	🚚
2	15	14	0,40	100	083170102
3	18	16	0,40	100	083170103
4	20	19	0,50	100	083170104
5	24	23	0,60	50	083170105
6	30	27	0,60	30	083170106
8	36	34	1,20	20	083170108
10	42	37	1,80	10	083170110

8317DZ

Doppelte Drahtseilklemmen, verzinkt



VERFÜGBARE ZERTIFIKATIONEN

- Abnahmeprüfzeugnis Typ 2.2 UNI EN10204

Ø mm	L mm	L1 mm	€	📦	🚚
2	30	14	0,50	50	083170002
3	35	15	0,60	50	083170003
4	40	18	0,70	50	083170004
5	50	21	0,90	25	083170005
6	60	25	1,10	20	083170006
8	76	33	2,20	10	083170008
10	95	37	3,30	10	083170010

8381SL

Rohrschellen, leichte Ausführung,
verzinkt

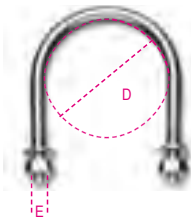

VERFÜGBARE ZERTIFIKATIONEN

- Produktspezifikation
- Abnahmeprüfzeugnis Typ 2.2 UNI EN10204

D mm	D gas	E mm	€	📦	🚚
11	1/8"	M6	0,70	100	083810201
14	1/4"	M6	0,70	100	083810202
18	3/8"	M6	0,70	100	083810203
22	1/2"	M6	0,90	100	083810204
27	3/4"	M6	0,90	100	083810205
34	1"	M6	0,90	100	083810206
43	1 1/4"	M6	0,90	100	083810207
49	1 1/2"	M8	1,60	50	083810208
61	2"	M8	1,60	50	083810209
77	2 1/2"	M8	1,90	25	083810210
89	3"	M8	2,00	25	083810211
102	3 1/2"	M8	2,20	25	083810212
115	4"	M8	2,50	25	083810213
140	5"	M8	5,30	25	083810215
168	6"	M10	5,70	25	083810218
220	8"	M10	11,50	10	083810220

8381SP

Rohrschellen, schwere Ausführung,
verzinkt

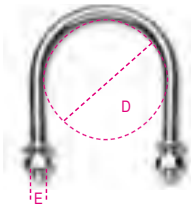

VERFÜGBARE ZERTIFIKATIONEN

- Produktspezifikation
- Abnahmeprüfzeugnis Typ 2.2 UNI EN10204

D mm	D gas	E mm	€	📦	🚚
22	1/2"	M8	1,10	100	083810301
27	3/4"	M8	1,20	100	083810302
34	1"	M8	1,30	100	083810303
43	1 1/4"	M8	1,40	100	083810304
49	1 1/2"	M10	2,40	25	083810305
61	2"	M10	2,50	25	083810306
77	2 1/2"	M10	2,90	25	083810307
89	3"	M10	3,10	25	083810308
102	3 1/2"	M12	4,80	25	083810309
115	4"	M12	5,30	15	083810310
140	5"	M12	8,10	15	083810312
168	6"	M16	13,50	15	083810315
220	8"	M16	23,70	10	083810320
274	10"	M16	25,00	1	083810374
274	10"	M20	36,00	1	083810375
324	12"	M20	76,00	1	083810386
408	16"	M24	111,50	1	083810508

Robur

Robur

8383C

Vierkant-Rohrschellen,
heiß verzinkt
Flanschmutter

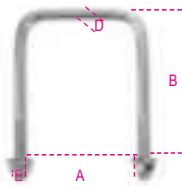

VERFÜGBARE ZERTIFIKATIONEN

- Produktspezifikation
- Abnahmeprüfzeugnis Typ 2.2 UNI EN10204

A mm	E mm	B mm	D mm	€		
70	M10	110	8,55	2,50	130	083830070
80	M10	120	8,55	2,80	110	083830080
90	M10	130	8,55	3,10	100	083830090
100	M10	155	8,55	3,60	90	083830100
120	M10	175	8,55	4,30	70	083830120

8383P

Platten für Vierkant-Rohrschellen,
heiß verzinkt

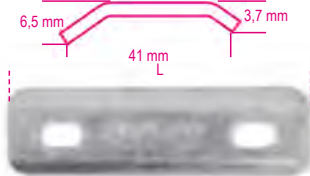

VERFÜGBARE ZERTIFIKATIONEN

- Produktspezifikation
- Abnahmeprüfzeugnis Typ 2.2 UNI EN10204

	L mm	€		
8383P 150	150	3,10	150	083830214
8383C/70-80 /90-100				
8383P 170	170	3,60	120	083830217
8383C/100-120				

8515Z

Drahtzieher für die Landwirtschaft
verzinkt

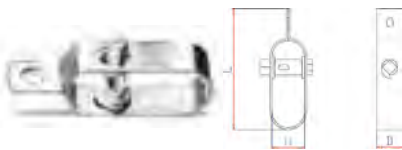

D mm	H mm	L mm	€		
20	25	93	1,70	50	085150002
24,5	30	100	2,20	50	085150003

8515V

Drahtzieher für die Landwirtschaft
lackiert

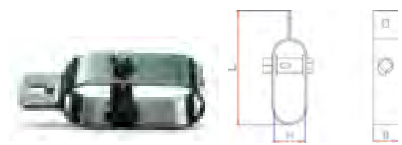

D mm	H mm	L mm	€		
20	25	93	2,10	50	085150102
24,5	30	100	2,70	50	085150103

8515CH

Schlüssel für Drahtzieher, verzinkt



L mm	OA mm	OB mm	€		
90	8	7,5	0,90	20	085150901

8531

Fischereischäkel, heißverzinkt

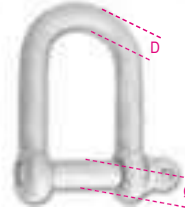

VERFÜGBARE ZERTIFIKATIONEN

- Abnahmeprüfzeugnis Typ 2.2 UNI EN10204

Ø mm	D mm	WFL kg	€		
20	18	1600	21,20	1	085310018
22	20	2500	31,00	1	085310020

8532

Fischereischäkel, schwarz lackiert

Vierkantbolzen

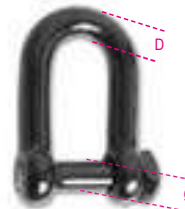

VERFÜGBARE ZERTIFIKATIONEN

- Abnahmeprüfzeugnis Typ 2.2 UNI EN10204

Ø mm	D mm	WFL kg	€		
20	20	1600	10,50	1	085320020
22	22	2500	15,90	1	085320022

8535

Fischereiagraffen
verzinkt

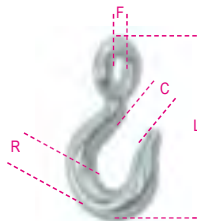

VERFÜGBARE ZERTIFIKATIONEN

- Abnahmeprüfzeugnis Typ 2.2 UNI EN10204

R mm	C mm	F mm	L mm	€		
26	27,5	34	156	23,70	1	085350006
30	36,5	40	185	33,00	1	085350007

8050 D1÷D45

Satz Sicherungen und Ersatzteile für
Ösenhaken



	€		
8050D1	9,30	1	080500945
8064S-8065SC/800-8055S/1250			
8050D2	10,70	1	080500946
8064S-8065SC/1000			
8062/1500-8055S/1600			
8050D3	11,60	1	080500947
8064S-8065SC/1600-2000			
8055S/2500-3200			
8050D4	19,20	1	080500948
8064S-8065SC/3200-8055S/5400			
8050D5	22,20	1	080500949
8064S-8065SC/5000-8055S/8000			
8050D6	35,50	1	080500950
8064S/7500-8055S/11500			
8050D11	18,30	1	080500955
8062/2000			
8050D12	20,20	1	080500956
8062/3000			
8050D13	36,50	1	080500957
8062/5000			
8050D22	48,00	1	080500966
8064S/10000			
8055S/16000			
8050D23	66,50	1	080500967
8055S/22000			
8050D24	0,90	1	080500969
8051S/250			
8050D25	1,03	1	080500970
8051S/500			
8050D30	27,00	1	080500975
8061F/8000			
8050D32	37,00	1	080500977
8060/8000			
8050D 33	3,80	1	080500978
8052/800			
8050D 34	4,30	1	080500979
8052/1120			
8050D 35	5,20	1	080500980
8052/2000			
8050D 36	5,60	1	080500981
8052/3150			
8050D 37	6,60	1	080500982
8052/4000			
8050D38	2,50	1	080500983
8060R/1120			
8050D53	3,40	1	080500994
8060R/1500			
8050D39	3,40	1	080500984
8060R/2000			
8050D40	5,80	1	080500985
8060R/3150			
8050D41	8,90	1	080500986
8060R/5300			
8050D42	0,90	1	080500987
8063/800			
8050D43	1,30	1	080500988
8063/1120			
8050D44	1,70	1	080500989
8063/2000			
8050D45	2,10	1	080500990
8063/3150			

8050D46	2,60	1	080500991
8061R/1120			
8050D47	2,60	1	080500992
8061R/2000			
8050D48	3,50	1	080500993
8061R/3150			
8050D54	3,50	1	080500995
8061R/5300			

8050D49	6,90	1	080500849
8057R - 8058R - 8063SL /1120			
8050D50	7,50	1	080500850
8057R - 8058R - 8063SL /2000			
8050D51	8,20	1	080500851
8057R - 8058R - 8063SL /3150			
8050D52	18,40	1	080500852
8057R - 8058R - 8063SL /5300			

8058R/PS

Satz Bolzen und Stifte für Haken Art. 8058R-8061R



	Ø mm	€		
8058R/PS 1,12	6	8,10	1	080580512
8058R/PS 2,0	7-8	9,30	1	080580520
8058R/PS 3,15	10	18,40	1	080580532
8058R/PS 5,3	13	32,00	1	080580553

8060R/PS

Satz Bolzen und Stifte für Haken Art. 8060R



	Ø mm	€		
8060R/PS 1,12	6	8,10	1	080600511
8060R/PS 1,5	7	9,30	1	080600515
8060R/PS 2,0	8	9,30	1	080600520
8060R/PS 3,15	10	18,40	1	080600532
8060R/PS 5,3	13	32,00	1	080600553

8135/KLA1

Kit Betätigungshebel für Hebezangen Art. 8135



8135 t	€		
0,75	18,00	1	081350605
1,00	22,40	1	081350610
2,00	26,00	1	081350615
3,00	31,50	1	081350620
5,00	48,00	1	081350625

Die Verantwortung für Reparaturen liegt beim Reparateur.

8135/KM0

Kit Feder für Hebezangen Art. 8135



8135 t	€		
0,75	8,00	1	081350655
1,00	11,70	1	081350660
2,00	15,20	1	081350665
3,00	19,60	1	081350670
5,00	29,00	1	081350675

Die Verantwortung für Reparaturen liegt beim Reparateur.

8143/RKL

Satz Ober- und Unterhakenlaschen für Handkettenzüge Art. 8143



8143 WLL t	€		
0,5	1,70	1	081430500
1,0	1,90	1	081430501
2,0	2,80	1	081430502
3,0	3,30	1	081430503
5,0	4,00	1	081430504

8143/RPC

Satz Stifte zur Kettenbefestigung am Haken für Handkettenzüge Art. 8143



8143 WLL t	€		
0,5	2,00	1	081430510
1,0	2,70	1	081430511
2,0	2,90	1	081430512
3,0	4,80	1	081430513
5,0	5,20	1	081430514

8143/RPF

Satz Anschlagstifte für Handkettenzüge Art. 8143



8143 WLL t	€		
0,5	0,90	1	081430520
1,0	1,00	1	081430521
2,0	1,40	1	081430522
3,0	1,10	1	081430523
5,0	1,70	1	081430524

8143/RKCI

Satz Unterhakenkörper für Handkettenzüge Art. 8143



8143 WLL t	€		
0,5	12,60	1	081430560
1,0	16,50	1	081430561
2,0	30,50	1	081430562
3,0	101,00	1	081430563
5,0	139,00	1	081430564

8146/RK

Satz Sicherungen, Bolzen, Endschalter für Handhebelzüge Art. 8146C-8146



8146C WLL t	€		
0,25	6,30	1	081460902

8146/RKL

Satz Ober- und Unterhakenlaschen für Handhebelzüge Art. 8146



8146 WLL t	€		
0,75	1,90	1	081460500
1,5	2,20	1	081460501
3,0	3,30	1	081460502
6,0	3,80	1	081460503

8146/RPC

Satz Stifte zur Kettenbefestigung am Haken für Handhebelzeuge Art. 8146



8146 WLL t	€		
0,75	2,00	1	081460510
1,5	2,90	1	081460511
3,0	3,10	1	081460512
6,0	3,10	1	081460513

8146/RKFC

Satz Anschlagstifte für Handhebelzüge Art. 8146



8146 WLL t	€		
0,75	5,20	1	081460520
1,5	6,70	1	081460521
3,0	7,10	1	081460522
6,0	8,30	1	081460523

 Robur

 Robur

Robur

8146/RKCI

Satz Unterhakenkörper
für Handhebelzüge Art. 8146



8146 WLL t	€	📄	📦
0,75	14,30	1	081460560
1,5	30,50	1	081460561
3,0	101,00	1	081460562
6,0	190,00	1	081460563

8148/RA

Seilhaspel für Handseilwinden Art. 8148



8148 t	€	📄	📦
0,8	22,80	1	081480900
1,6	30,50	1	081480901
3,2	39,50	1	081480902

8148/RKS

Überlastabscherbolzensatz, 3-teilig,
für Handseilwinden Art. 8148



8148 t	€	📄	📦
0,8	4,30	1	081480903
1,6 - 3,2	5,40	1	081480904

8148/RKCM

Griffkappensatz, 2-teilig,
für Handseilwinden Art. 8148



8148/RKCM	€	📄	📦
	1,90	1	081480905

8148/RKCL

Hebelkappensatz, 2-teilig,
für Handseilwinden Art. 8148



8148/RKCL	€	📄	📦
	2,10	1	081480906

8148/RP

Ankerbolzen
für Handseilwinden Art. 8148



8148 t	€	📄	📦
0,8	17,50	1	081480907
1,6	23,50	1	081480908
3,2	29,50	1	081480909

8148/RKG

Schutzummantelungssatz, 2-teilig,
für Handseilwinden Art. 8148



8148 t	€	📄	📦
0,8	18,00	1	081480910
1,6	20,60	1	081480911
3,2	21,70	1	081480912



8149

Hochfeste Ketten, aus legiertem Stahl

CE

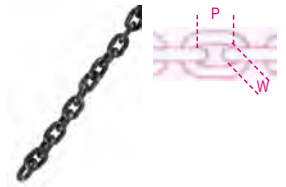

EN 818-7

TECHNISCHE DATEN

- Sicherheitskoeffizient: 4
- Wärmebehandlung: Vergütung
- Herstellungsnummer

LABORANALYSEN

- Chemische Analyse
- Metallographische Analyse
- Zerreißprobe

VERFÜGBARE ZERTIFIKATIONEN

- Produktspezifikation
- Abnahmeprüfzeugnis Typ 2.2 UNI EN10204
- CE-Konformitätserklärung

Ø mm	WLL Kg	P mm	W min	€/m	📄	📦
4	500	12	4,8	17,20	1	081490012
5	800	15	6,0	21,20	1	081490015
6	1100	18	7,2	23,80	1	081490018
6,3	1200	19	7,6	26,50	1	081490019
8	2000	24	9,6	36,00	1	081490024
10	3200	30	12	55,50	1	081490030

8149CM

Handketten für Handkettenzüge Art. 8143

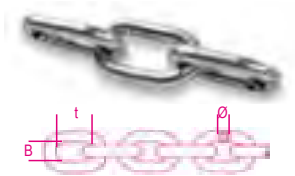

Ø mm	B mm	t mm	€/m	📄	📦
4,8	8,2	22,2	6,30	1	081490001

*** ACHTUNG:** Das Produkt wird mit einem einzigen Kettenstrang geliefert, sofern im Auftrag nicht anders angegeben!

8149CM/RA

Verschweißter Ersatzring
Handkette für Handkettenzüge Art. 8143



L m	Ø mm	B mm	€	📄	📦
3	4,8	8,2	69,50	1	081490903
6	4,8	8,2	106,00	1	081490906

*Geschlossener verschweißter Ring. Zum Wechseln der Kette das Handbuch sorgfältig lesen.



Im Gegensatz zu herkömmlichem Edelstahl (AISI 304) bietet der von uns ausgewählte Stahl AISI 316 eine höhere Beständigkeit gegen Witterungseinflüsse, Salzkorrosion und organische Säuren. Der Edelstahl AISI 316 enthält hohe Mengen an:

- **Chrom** (bildet eine Oberflächenschicht, die das darunter liegende Material vor Oxidation schützt)
- **Molybdän** (erhöht die Korrosionsbeständigkeit von Chloriden, wie Meerwasser oder Enteisungsmitteln)
- **Nickel** (hält die Stahlstruktur über die Zeit stabil)

Der geringe Kohlenstoffgehalt macht diesen Stahl auch widerstandsfähiger gegen anorganische Korrosion, eine besondere Art der Korrosion, die an der Oberfläche des Zubehörs schwer zu erkennen ist und in korrosiven Umgebungen zu plötzlichen Brüchen führen kann.

Der Stahl AISI 316 zeichnet sich zudem durch leichtes Reinigen, seinen ausgezeichneten Hygienekoeffizient, seine amagnetischen Eigenschaften und seine mechanische Leistungsfähigkeit bei niedrigen Temperaturen aus.

Aber am wichtigsten für die Zuverlässigkeit der Produkte von Robur Inox ist zweifelsohne ihre gleichbleibende und konstante Qualität, die allen Produktionschargen das gleiche Leistungsniveau gewährleistet, gestern, heute und morgen.

8205

Spannschlösser mit zwei Ösen
Edelstahl AISI 316

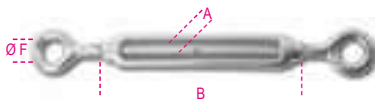

TECHNISCHE DATEN

- Mindest-Sicherheitskoeffizient: 4
- Identifizierungscode

LABORANALYSEN

- Zerreißprobe

VERFÜGBARE ZERTIFIKATIONEN

- Produktspezifikation
- Abnahmeprüfzeugnis Typ 2.2 UNI EN10204

A mm	B mm	øF mm	WFL kg	€	📦	🚚
M4	62	8	75	7,00	10	082050204
M5	72	11	115	8,30	10	082050205
M6	92	12	160	11,00	8	082050206
M8	122	14	300	16,80	8	082050208
M10	150	16	470	25,50	4	082050210
M12	201	18	690	43,00	1	082050212
M14	225	22	940	107,50	1	082050214
M16	244	26	1290	109,50	1	082050216
M20	295	29	2130	158,00	1	082050220
M24	350	33	3000	362,00	1	082050224

8206

Spannschlösser mit Haken und Ose
Edelstahl AISI 316

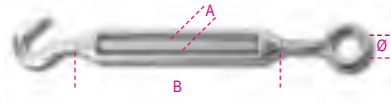

LABORANALYSEN

- chemische Analyse

- Zerreißprobe

VERFÜGBARE ZERTIFIKATIONEN

- Produktspezifikation
- Abnahmeprüfzeugnis Typ 2.2 UNI EN10204

A mm	B mm	øF mm	WFL kg	€	📦	🚚
M5	72	11	25	8,40	10	082060205
M6	92	12	45	11,60	5	082060206
M8	122	14	95	17,60	5	082060208
M10	150	16	140	27,00	1	082060210
M12	201	18	300	40,00	1	082060212
M14	225	22	420	108,00	1	082060214
M16	244	26	570	110,00	1	082060216
M20	295	29	875	161,00	1	082060220

8209

Spannschlösser mit zwei Gabeln
Edelstahl AISI 316

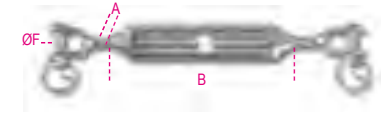

LABORANALYSEN

- chemische Analyse

- Zerreißprobe

VERFÜGBARE ZERTIFIKATIONEN

- Produktspezifikation
- Abnahmeprüfzeugnis Typ 2.2 UNI EN10204

A mm	B mm	øF mm	WFL kg	€	📦	🚚
M5	72	5	115	14,80	5	082090205
M6	92	6	160	17,40	5	082090206
M8	122	8	300	25,00	5	082090208
M10	150	10	470	41,00	1	082090210
M12	201	12	690	66,00	1	082090212
M14	225	14	940	89,00	1	082090214
M16	244	16	1290	134,00	1	082090216
M20	295	20	2130	235,50	1	082090220
M24	350	24	3060	572,00	1	082090224

Spezielle Verpackungen Spannschlösser



A mm	B mm	📦	€	🚚
M4	62	5	39,00	1 082050704
M5	72	5	47,00	1 082050705
M6	92	4	50,00	1 082050706
M8	122	4	76,00	1 082050708
M10	150	2	58,00	1 082050710

8207

Spannschlösser mit zwei Haken
Edelstahl AISI 316

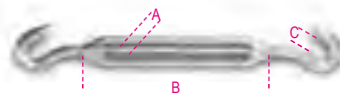

LABORANALYSEN

- chemische Analyse

- Zerreißprobe

VERFÜGBARE ZERTIFIKATIONEN

- Produktspezifikation
- Abnahmeprüfzeugnis Typ 2.2 UNI EN10204

A mm	B mm	C mm	WFL kg	€	📦	🚚
M5	72	9	25	8,90	10	082070205
M6	92	9	45	11,70	5	082070206
M8	122	10	95	17,90	5	082070208
M10	150	12	140	27,50	1	082070210
M12	201	14	300	46,00	1	082070212
M14	225	15	420	109,50	1	082070214
M16	244	16	570	113,50	1	082070216
M20	295	19	875	166,50	1	082070220

8210

Spannschlösser mit zwei Gabeln und Rohrmutter
Edelstahl AISI 316

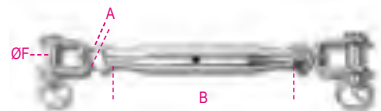

LABORANALYSEN

- chemische Analyse

- Zerreißprobe

VERFÜGBARE ZERTIFIKATIONEN

- Produktspezifikation
- Abnahmeprüfzeugnis Typ 2.2 UNI EN10204

A mm	B mm	øF mm	WFL kg	€	📦	🚚
M5	81	5	115	18,60	3	082100205
M6	92	6	160	22,40	3	082100206
M8	112	8	300	32,50	1	082100208
M10	121	10	470	51,00	1	082100210
M12	150	12	690	84,50	1	082100212
M14	169	14	940	109,50	1	082100214
M16	190	16	1290	162,00	1	082100216
M20	220	20	2130	281,00	1	082100220

8210FTP

Spannschlösser mit Gabel und Pressterminal
Rohrmutter
Edelstahl AISI 316

Stahl mit Nickel, Chrom und Molybdän, für höhere
Korrosionsbeständigkeit.

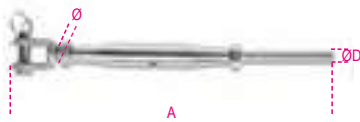

LABORANALYSEN

- chemische Analyse
- Zerreißprobe

VERFÜGBARE ZERTIFIKATIONEN

- Produktspezifikation
- Abnahmeprüfzeugnis Typ 2.2 UNI EN10204

Ø mm	A mm	ØD mm	WFL kg	€		
M5	159	2,70	150	20,70	2	082100605
M6	179	3,30	250	24,50	2	082100606
M8	216	4,30	350	33,50	1	082100608
M10	241	5,30	550	51,50	1	082100610
M12	300	6,30	1000	75,00	1	082100612
M14	345	7,30	1350	113,50	1	082100614
M16	383	8,30	1625	165,00	1	082100616
M20	484	10,50	2125	280,00	1	082100620

8201T

Rohrspannschlossmutter
Edelstahl AISI 316



LABORANALYSEN

- chemische Analyse
- Zerreißprobe

VERFÜGBARE ZERTIFIKATIONEN

- Produktspezifikation
- Abnahmeprüfzeugnis Typ 2.2 UNI EN10204

Ø mm	Ø "	WFL kg	L mm	€		
M6	1/4	160	95	4,30	5	082010406
M8	5/16	300	105	6,20	5	082010408
M10	3/8	470	125	10,30	3	082010410
M12	1/2	690	150	17,90	3	082010412
M14	9/16	940	165	19,50	1	082010414
M16	5/8	1290	190	32,50	1	082010416
M20	3/4	2130	210	48,50	1	082010420

8210F

Gabeln für Spannschlösser
Edelstahl AISI 316

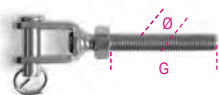

LABORANALYSEN

- Chemische Analyse
- Zerreißprobe

VERFÜGBARE ZERTIFIKATIONEN

- Produktspezifikation
- Abnahmeprüfzeugnis Typ 2.2 UNI EN10204

Ø mm	≈	G mm	WFL kg	€		
M5	3/16	38,5	115	6,20	4	082100305
M6	1/4	49	160	7,00	4	082100306
M8	5/16	56	300	10,10	4	082100308
M10	3/8	61	470	17,20	2	082100310
M12	1/2	81	690	27,00	2	082100312
M14	9/16	93	940	42,50	2	082100314

Gabeln für Spannschlösser, rechtsgängig - verzinkt

Ø mm	≈	G mm	WFL kg	€		
M5	3/16	38,5	115	6,20	4	082100405
M6	1/4	49	160	7,00	4	082100406
M8	5/16	56	300	10,10	4	082100408
M10	3/8	61	470	17,20	2	082100410
M12	1/2	81	690	27,00	2	082100412
M14	9/16	93	940	43,50	2	082100414

8248

Augenschrauben,
Edelstahl 316L,
Rechtsgewinde

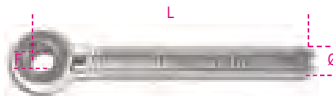

UNI 6058

VERFÜGBARE ZERTIFIKATIONEN

- Produktspezifikation
- Abnahmeprüfzeugnis Typ 2.2 UNI EN10204

ØxL mm	F mm	€		
8X120	6	8,10	1	082480008
10x80	8	10,80	1	082480010
10x130	8	14,50	1	082480012
12x95	10	16,40	1	082480016
12x125	10	19,50	1	082480018

8249

Dübelösen
Edelstahl AISI 316



LABORANALYSEN

- chemische Analyse
- Zerreißprobe

VERFÜGBARE ZERTIFIKATIONEN

- Produktspezifikation
- Abnahmeprüfzeugnis Typ 2.2 UNI EN10204

A mm	WFL kg	D mm	€		
M5	100	50	3,10	10	082490205
M6	160	55	3,80	10	082490206
M8	300	60	6,10	5	082490208
M10	470	80	10,80	5	082490210
M12	690	120	18,80	2	082490212

8249G

Dübelhaken
Edelstahl AISI 316



LABORANALYSEN

- chemische Analyse
- Zerreißprobe

VERFÜGBARE ZERTIFIKATIONEN

- Produktspezifikation
- Abnahmeprüfzeugnis Typ 2.2 UNI EN10204

A mm	E mm	ØF mm	WFL kg	€		
M5	39	9	25	1,60	5	082490305
M6	43	10,5	45	1,80	5	082490306
M8	57	14,5	95	3,10	3	082490308

8216

Gusseisen
Edelstahl AISI 316

CE

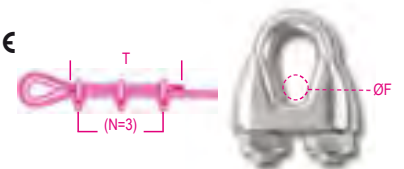

LABORANALYSEN

- chemische Analyse
- Drehmomenttest

VERFÜGBARE ZERTIFIKATIONEN

- Produktspezifikation
- Abnahmeprüfzeugnis Typ 2.2 UNI EN10204
- * CE-Konformitätserklärung

Ø F mm	"	T	N	€		
2	5/64	80	3	3,60	20	082160202
3	1/8	80	3	3,60	20	082160203
4	5/32	80	3	4,10	20	082160204
5	3/16	110	3	4,70	20	082160205
6	1/4	120	5	5,10	10	082160206
8	5/16	210	5	6,80	10	082160208
10	3/8	240	5	9,40	8	082160210
12-13	1/2	300	5	13,00	5	082160213
16	5/8	335	5	19,10	5	082160216
20	3/4	540	5	24,10	5	082160220
22	7/8	595	7	38,50	3	082160222

Spezielle Verpackungen
Gusseisen-Klemmen



Ø F mm	"	€		
2	5/64	40,00	1	082160702
3	1/8	40,00	1	082160703
4	5/32	45,00	1	082160704
5	3/16	51,00	1	082160705
6	1/4	29,00	1	082160706
8	5/16	38,00	1	082160708
10	3/8	42,00	1	082160710

Sonderverpackungen für den freien
Service



Ø F mm		€		
2	4	14,70	1	082169402
3	4	14,80	1	082169403
4	4	16,60	1	082169404
5	2	10,10	1	082169405
6	2	11,30	1	082169406
8	2	14,70	1	082169408
10	2	19,80	1	082169410

Robur

8220

Kauschen
Edelstahl AISI 316

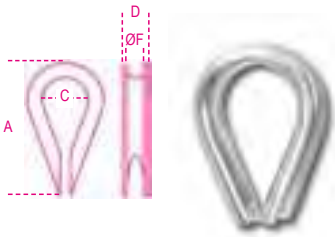

LABORANALYSEN

- chemische Analyse
- VERFÜGBARE ZERTIFIKATIONEN
- Produktspezifikation
- Abnahmeprüfzeugnis Typ 2.2 UNI EN10204

ø F mm	D mm	A mm	C mm	€	📦	🚚
2	4,5	21	7,5	1,20	15	082200202
3	6	24	10	1,40	15	082200203
4	6,6	28	11	1,60	10	082200204
5	8,5	30	13	1,80	10	082200205
6	10	37	15	2,10	10	082200206
8	12,5	51	23	3,20	5	082200208
10	14,6	56	27	3,80	5	082200210
12	18	68	32	5,20	5	082200212
14	19	69	34	6,80	5	082200214
16	22	83	37	7,50	5	082200216
18	23	81	38	8,90	1	082200218
20	27,8	105	45	10,50	1	082200220
22	29,6	112	45	13,60	1	082200222

8225

Gerade Schäkel
Edelstahl AISI 316



LABORANALYSEN

- chemische Analyse
- Zerreißprobe
- VERFÜGBARE ZERTIFIKATIONEN
- Produktspezifikation
- Abnahmeprüfzeugnis Typ 2.2 UNI EN10204

ø D mm	A mm	WFL kg	€	📦	🚚	
4	5/32	8	50	3,70	20	082250204
5	3/16	11	70	4,10	20	082250205
6	1/4	13	100	4,50	10	082250206
8	5/16	17	250	7,20	10	082250208
10	3/8	21	400	10,30	8	082250210
12	1/2	25	600	16,80	3	082250212
16	5/8	32	1000	37,00	1	082250216
19	3/4	38	1600	61,50	1	082250219
22	7/8	43	2000	95,50	1	082250222
25	1	46	2800	139,50	1	082250225

Spezielle Verpackungen
Schäkel



ø D mm	A mm	WFL kg	€	📦	🚚
4	5/32	10	42,00	1	082250704
5	3/16	10	46,00	1	082250705
6	1/4	5	25,00	1	082250706
8	5/16	5	40,00	1	082250708
10	3/8	4	46,00	1	082250710

8227

Gerade Schäkel, lange Ausführung
Edelstahl AISI 316



LABORANALYSEN

- chemische Analyse
- Zerreißprobe
- VERFÜGBARE ZERTIFIKATIONEN
- Produktspezifikation
- Abnahmeprüfzeugnis Typ 2.2 UNI EN10204

ø D mm	A mm	WFL kg	€	📦	🚚	
4	5/32	8	50	3,20	10	082270204
5	3/16	10	70	3,60	10	082270205
6	1/4	13,5	100	4,60	5	082270206
8	5/16	17	250	7,40	5	082270208
10	3/8	21	400	12,10	2	082270210
12	1/2	25	600	19,20	1	082270212

8228

Herzförmige Schäkel
Edelstahl AISI 316

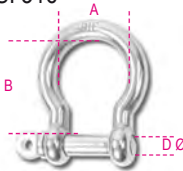

LABORANALYSEN

- chemische Analyse
- Zerreißprobe
- VERFÜGBARE ZERTIFIKATIONEN
- Produktspezifikation
- Abnahmeprüfzeugnis Typ 2.2 UNI EN10204

ø D mm	A mm	B mm	WFL kg	€	📦	🚚
4	13	20	60	2,90	10	082280204
5	17	23	80	3,30	10	082280205
6	20	27	100	3,70	10	082280206
8	28	36	200	5,90	5	082280208
10	36	44	300	9,40	5	082280210
12	41	53	500	14,90	5	082280212
16	54	74	800	33,00	1	082280216
19	66	86	1100	59,00	1	082280219

8240F

Ringschrauben, GESCHMIEDET,
Edelstahl A4

CE



TECHNISCHE DATEN

- Mindest-Sicherheitskoeffizient: 6
- Herstellungsnummer
- LABORANALYSEN
- chemische Analyse
- metallographische Analyse
- Zerreißprobe
- VERFÜGBARE ZERTIFIKATIONEN
- Produktspezifikation
- Abnahmeprüfzeugnis Typ 2.2 UNI EN10204
- Prüfbescheinigung Typ3.1 UNI EN10204
- CE-Konformitätserklärung

ø mm	WLL kg	€	📦	🚚	
M6	1,0	120	8,40	4	082400406
* M8	1,25	200	9,40	4	082400408
* M10	1,5	400	15,70	4	082400410
* M12	1,75	600	25,50	4	082400412
* M14	2	1000	41,00	2	082400414
* M16	2	1200	41,00	2	082400416
* M20	2,5	2000	66,00	2	082400420
* M24	3	2700	124,50	2	082400424
* M30	3,5	4000	276,00	1	082400430

8240

Ringschrauben
Edelstahl AISI 316

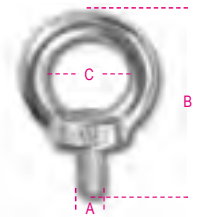

LABORANALYSEN

- chemische Analyse
- Zerreißprobe
- VERFÜGBARE ZERTIFIKATIONEN
- Produktspezifikation
- Abnahmeprüfzeugnis Typ 2.2 UNI EN10204

A mm	B mm	ø C mm	WFL kg	€	📦	🚚
M6	41	15	90	2,50	10	082400206
M8	50	20	140	3,70	10	082400208
M10	62	25	230	7,20	5	082400210
M12	74	30	340	12,10	5	082400212

8242F

Ringmuttern, GESCHMIEDET,
Edelstahl A4

CE



TECHNISCHE DATEN

- Mindest-Sicherheitskoeffizient: 6
- Herstellungsnummer

LABORANALYSEN

- chemische Analyse
- metallographische Analyse
- Zerreißprobe

VERFÜGBARE ZERTIFIKATIONEN

- Produktspezifikation
- Abnahmeprüfzeugnis Typ 2.2 UNI EN10204
- Prüfbescheinigung Typ3.1 UNI EN10204
- CE-Konformitätserklärung

ø mm	WLL kg	WLL kg	€		
M6	1,0	120	8,40	4	082420406
* M8	1,25	200	9,40	4	082420408
* M10	1,5	400	15,70	4	082420410
* M12	1,75	600	25,50	4	082420412
* M14	2	1000	41,00	2	082420414
* M16	2	1200	41,00	2	082420416
* M20	2,5	2000	66,00	2	082420420
* M24	3	2700	124,50	2	082420424
* M30	3,5	4000	276,00	1	082420430

8242

Ringmuttern
Edelstahl AISI 316



A mm	B mm	ø C mm	WFL kg	€		
M6	27	15	90	2,50	10	082420206
M8	36	20	140	3,70	10	082420208
M10	45	25	230	7,20	5	082420210
M12	55	30	340	12,10	5	082420212

8274

Karabinerhaken
Edelstahl AISI 316

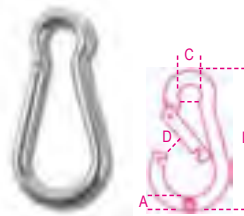

LABORANALYSEN

- chemische Analyse
- Zerreißprobe

VERFÜGBARE ZERTIFIKATIONEN

- Produktspezifikation
- Abnahmeprüfzeugnis Typ 2.2 UNI EN10204

ø A x L mm	ø C mm	D mm	WFL kg	€		
4,5x40	6,5	6	20	3,30	20	082740204
5x50	7	6,5	30	3,30	20	082740205
6x60	8,5	7,5	40	3,60	10	082740206
7x70	10	9	60	4,30	10	082740207
8x80	12	10	75	5,60	10	082740208
9x90	12,5	10,5	100	7,70	10	082740209
10x100	15	13	120	9,60	8	082740210
11x120	19	18	140	13,60	1	082740211
12x140	22	21	140	18,50	1	082740212
13x160	22	26	200	23,20	1	082740213

Spezielle Verpackungen Karabinerhaken



ø A x L mm	ø C mm	WFL kg	€		
4,5x40	6,5	10	37,00	1	082740704
5x50	7	10	37,00	1	082740705
6x60	8,5	5	20,00	1	082740706
7x70	10	5	24,00	1	082740707
8x80	12	5	32,00	1	082740708
9x90	12,5	5	43,00	1	082740709
10x100	15	4	43,00	1	082740710

8274A

Karabinerhaken mit Ring
Edelstahl AISI 316

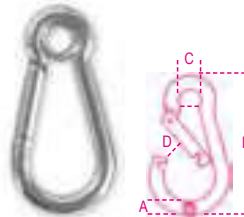

LABORANALYSEN

- chemische Analyse
- Zerreißprobe

VERFÜGBARE ZERTIFIKATIONEN

- Produktspezifikation
- Abnahmeprüfzeugnis Typ 2.2 UNI EN10204

ø A x L mm	ø C mm	D mm	WFL kg	€		
5x50	6,5	7	30	3,30	10	082740405
6x60	7,5	7,5	40	4,00	5	082740406
8x80	9,5	10	75	6,40	5	082740408

8274G

Karabinerhaken mit Nutmutter
Edelstahl AISI 316

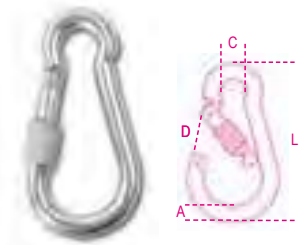

LABORANALYSEN

- chemische Analyse
- Zerreißprobe

VERFÜGBARE ZERTIFIKATIONEN

- Produktspezifikation
- Abnahmeprüfzeugnis Typ 2.2 UNI EN10204

ø A x L mm	ø C mm	D mm	WFL kg	€		
6x60	8,5	6,5	40	4,40	5	082740306
8x80	12	8,5	75	7,70	5	082740308
10x100	15	12	120	14,70	3	082740310

8276

Asymmetrische Karabinerhaken
Edelstahl AISI 316

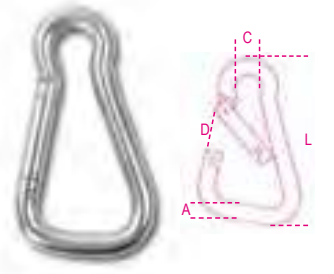

LABORANALYSEN

- chemische Analyse
- Zerreißprobe

VERFÜGBARE ZERTIFIKATIONEN

- Produktspezifikation
- Abnahmeprüfzeugnis Typ 2.2 UNI EN10204

ø A x L mm	ø C mm	D mm	WFL kg	€		
6x60	8,5	10	40	4,00	5	082760206
8x80	12	14	75	6,90	5	082760208
10x100	15	18	120	11,80	3	082760210

Robur

Robur

8276G

Asymmetrische Karabinerhaken mit Nutmutter
Edelstahl AISI 316

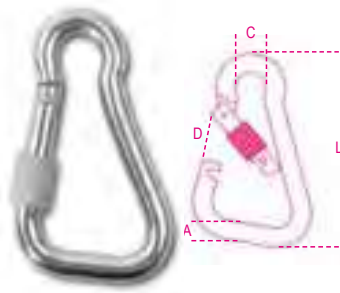

LABORANALYSEN

- chemische Analyse
- Zerreiprobe

VERFGBARE ZERTIFIKATIONEN

- Produktspezifikation
- Abnahmeprfzeugnis Typ 2.2 UNI EN10204

∅ A x L	∅ C	D	WFL	€	W	L
mm	mm	mm	kg			
6x60	8,5	9	40	5,00	3	082760306
8x80	12	12,5	75	8,90	3	082760308
10x100	15	16	120	16,10	3	082760310

8278

Trapezhaken
Edelstahl AISI 316

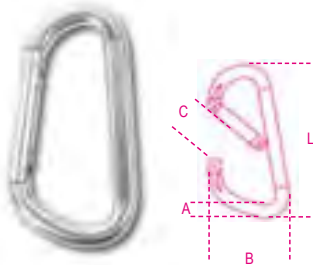

LABORANALYSEN

- chemische Analyse
- Zerreiprobe

VERFGBARE ZERTIFIKATIONEN

- Produktspezifikation
- Abnahmeprfzeugnis Typ 2.2 UNI EN10204

∅ A x L	B	C	WFL	€	W	L
mm	mm	mm	kg			
8x80	45	14	75	14,90	3	082780208
10x100	55	16	120	23,20	3	082780210

Robur

8280

Kettenschnellverschlsse
Edelstahl AISI 316

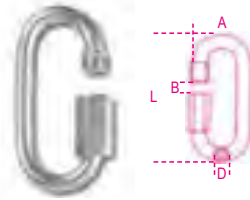

LABORANALYSEN

- chemische Analyse
- Zerreiprobe

VERFGBARE ZERTIFIKATIONEN

- Produktspezifikation
- Abnahmeprfzeugnis Typ 2.2 UNI EN10204

∅ D x L	A	B	WFL	€	W	L
mm	mm	mm	kg			
3,5x35	17	5	20	3,90	10	082800203
4x40	19	6	30	4,10	10	082800204
5x50	23	7	50	5,00	5	082800205
6x60	26	8	60	5,90	5	082800206
7x70	30	9	100	6,90	5	082800207
8x80	33	10	140	9,50	2	082800208
10x90	40	12	220	15,40	2	082800210
12x100	47	14	300	23,20	1	082800212

8250

Haken mit Sicherung
Edelstahl AISI 316



LABORANALYSEN

- chemische Analyse
- Zerreiprobe

VERFGBARE ZERTIFIKATIONEN

- Produktspezifikation
- Abnahmeprfzeugnis Typ 2.2 UNI EN10204

L	A	∅ B	WFL	€	W	L
mm	mm	mm	kg			
50	25	8	40	4,90	5	082500205
70	31	12,5	90	7,30	5	082500207
100	47	20	190	11,80	2	082500210

8264

Haken mit Wirbel
Edelstahl AISI 316

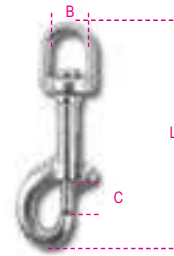

LABORANALYSEN

- chemische Analyse
- Zerreiprobe

VERFGBARE ZERTIFIKATIONEN

- Produktspezifikation
- Abnahmeprfzeugnis Typ 2.2 UNI EN10204

B	L	C	WFL	€	W	L
mm	mm	mm	kg			
12	88	12	60	12,90	5	082640212
16	90	12	60	13,30	5	082640216
19	93	12	60	13,40	2	082640219

8267

Haken mit Wirbel und Sicherung
Edelstahl AISI 316



LABORANALYSEN

- chemische Analyse
- Zerreiprobe

VERFGBARE ZERTIFIKATIONEN

- Produktspezifikation
- Abnahmeprfzeugnis Typ 2.2 UNI EN10204

A	L	B	WFL	€	W	L
mm	mm	mm	kg			
10	87	21	30	11,30	5	082670210
12	118	22	70	19,00	2	082670213

Robur

8272
Wirbel mit zwei Ösen
Edelstahl AISI 316

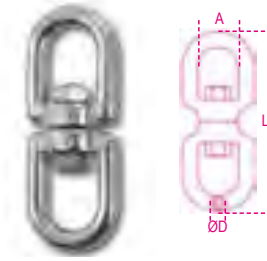

- LABORANALYSEN**
- chemische Analyse
 - Zerreißprobe
- VERFÜGBARE ZERTIFIKATIONEN**
- Produktspezifikation
 - Abnahmeprüfzeugnis Typ 2.2 UNI EN10204

ø D mm	A mm	L mm	WFL kg	€		
4	11	50	90	6,40	5	082720204
5	13	60	115	8,40	5	082720205
6	15	66	140	10,30	5	082720206
8	19	90	250	16,60	3	082720208
10	23	112	300	25,50	1	082720210
13	33	148	650	51,50	1	082720213
16	38	184	1000	96,00	1	082720216
19	40	223	1600	171,50	1	082720219

8273
Karabinerhaken mit Schnellverschluss
und Schwenkauge
Edelstahl AISI 316

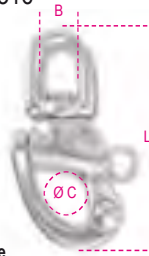

- LABORANALYSEN**
- chemische Analyse
 - Zerreißprobe
- VERFÜGBARE ZERTIFIKATIONEN**
- Produktspezifikation
 - Abnahmeprüfzeugnis Typ 2.2 UNI EN10204

ø C x L mm	B mm	WFL kg	BF kg	€		
12x70	12	230	1100	19,50	1	082730012
16x85	14,50	440	2000	27,00	1	082730016
22x120	20	700	3500	42,50	1	082730022

8282S
"S"-förmige Haken, symmetrisch
Edelstahl AISI 316

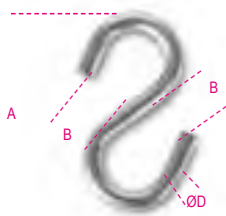

- LABORANALYSEN**
- chemische Analyse
 - Zerreißprobe
- VERFÜGBARE ZERTIFIKATIONEN**
- Produktspezifikation
 - Abnahmeprüfzeugnis Typ 2.2 UNI EN10204

ø D mm	B mm	A mm	WFL kg	€		
3	5,5	34	4	0,50	40	082820303
4	7,0	40	5	0,90	30	082820304
5	9,0	46	12	1,20	20	082820305
6	10	54	18	2,10	15	082820306

8284
Pelikanhaken
Edelstahl AISI 316



- LABORANALYSEN**
- chemische Analyse
 - Zerreißprobe
- VERFÜGBARE ZERTIFIKATIONEN**
- Produktspezifikation
 - Abnahmeprüfzeugnis Typ 2.2 UNI EN10204

ø C mm	B mm	L mm	WFL kg	€		
6	11	73	200	18,80	3	082840006
8	14	98	300	25,50	3	082840008
10	23	143	450	52,50	1	082840010

8285
Gabelkopfterminals
Edelstahl AISI 316

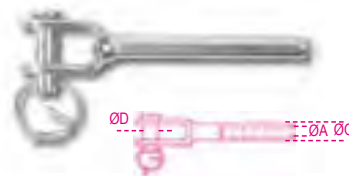

- LABORANALYSEN**
- chemische Analyse
 - Zerreißprobe
- VERFÜGBARE ZERTIFIKATIONEN**
- Produktspezifikation
 - Abnahmeprüfzeugnis Typ 2.2 UNI EN10204

ø A M	ø C mm	ø D mm	WFL kg	€		
3	6,3	6	180	3,80	5	082850203
4	7,5	8	200	6,10	3	082850204
5	9	10	330	8,30	2	082850205
6	12,5	12	720	17,20	2	082850206
7	12,5	12	850	18,40	2	082850207
8	15,5	16	1120	24,60	2	082850208
10	18	16	1300	34,50	2	082850210
12	20	19	2400	41,50	2	082850212

8286
Augterminals
Edelstahl AISI 316



- LABORANALYSEN**
- chemische Analyse
 - Zerreißprobe
- VERFÜGBARE ZERTIFIKATIONEN**
- Produktspezifikation
 - Abnahmeprüfzeugnis Typ 2.2 UNI EN10204

ø D M	ø A mm	ø C mm	WFL kg	€		
3	6,5	6,3	180	4,00	5	082860203
4	8,5	7,5	200	4,60	3	082860204
5	10	9	330	6,10	2	082860205
6	12,5	12,6	720	9,90	2	082860206
7	12,5	14,2	850	10,70	2	082860207
8	14,5	16	1120	17,90	2	082860208
10	16,4	18	1300	31,50	2	082860210
12	19,3	20	2400	44,50	2	082860212

8287
Gewindeterminals
Edelstahl AISI 316



- LABORANALYSEN**
- chemische Analyse
 - Zerreißprobe
- VERFÜGBARE ZERTIFIKATIONEN**
- Produktspezifikation
 - Abnahmeprüfzeugnis Typ 2.2 UNI EN10204

ø D M	ø A mm	E mm	WFL kg	€		
3	6,2	M6	180	3,50	5	082870203
4	7,5	M8	200	4,90	3	082870204
5	8,7	M10	330	6,80	2	082870205
6	12,6	M12	720	12,30	2	082870206
7	12,6	M14	850	17,00	2	082870207
8	16	M16	1120	24,60	2	082870208
10	18	M16	1300	27,50	2	082870210
12	20	M20	2400	37,50	2	082870212

8290
Fenderösen
Edelstahl AISI 316

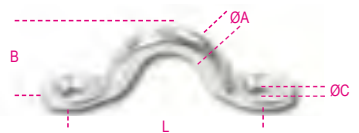

- LABORANALYSEN**
- chemische Analyse
 - Zerreißprobe
- VERFÜGBARE ZERTIFIKATIONEN**
- Produktspezifikation
 - Abnahmeprüfzeugnis Typ 2.2 UNI EN10204

ø A mm	B mm	ø C mm	L mm	€		
5	18	4,3	40	1,40	5	082900205
6	22	5,2	44	1,80	5	082900206
8	23	5,2	51	2,80	5	082900208



8381SX Rohrschellen

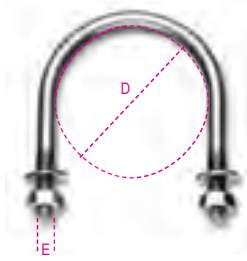

AISI 304

LABORANALYSEN

• chemische Analyse

VERFÜGBARE ZERTIFIKATIONEN

• Abnahmeprüfzeugnis Typ 2.2 UNI EN10204

D mm	D gas	E mm	€		
11	1/8"	M6	3,10	20	083810401
14	1/4"	M6	3,20	20	083810402
18	3/8"	M6	3,20	20	083810403
22	1/2"	M6	3,30	20	083810404
27	3/4"	M6	3,30	20	083810405
34	1"	M6	3,70	20	083810406
43	1 1/4"	M6	4,10	20	083810407
49	1 1/2"	M8	7,20	10	083810408
61	2"	M8	7,90	10	083810409
77	2 1/2"	M8	9,10	10	083810410
89	3"	M8	10,10	10	083810412
115	4"	M8	13,00	10	083810413
168	6"	M10	24,60	1	083810416
220	8"	M10	29,50	1	083810418

8279

Kettentyp "Genovese"
für statische Verbindungen
Edelstahl AISI 304



TECHNISCHE DATEN

• Mindest-Sicherheitskoeffizient: 4

VERFÜGBARE ZERTIFIKATIONEN

• Produktspezifikation

• Abnahmeprüfzeugnis Typ 2.2 UNI EN10204

Ø mm	nr	WFL kg	m	€		
2	13	20	50	290,00	1	082790020
3	17	55	50	529,00	1	082790030
4	19	100	50	746,00	1	082790040
5	21	250	40	820,00	1	082790050
6	23	310	30	834,00	1	082790060
8	27	400	15	820,00	1	082790080
10	30	1000	10	1.285,00	1	082790400

Achtung: Das Produkt ist NICHT zum Heben bestimmt

Robur

8293

Zurrurte mit Ratsche AISI 304
Band aus hochreiß- und zugfestem Polyester
LC 300 kg
Zughaken
in aufhängbarer Verpackung

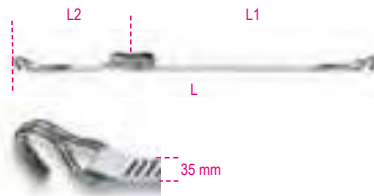

L m	L2 mm	L1 mm	STF daN	€		
6	5700	300	100	83,50	1	082930106

LC = 300 kg

8297C

Zurrurte mit Mini-Rundratsche, LC 700 kg,
AISI 304
hochfestes Polyesterband

in aufhängbarer Verpackung

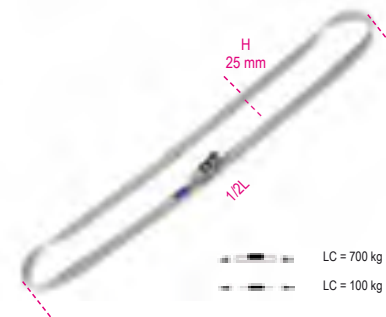

LC = 700 kg
LC = 100 kg

L m	H mm	€		
5	25	35,50	1	082970350

8297F

2 Klemmschnallen, LC 250 kg,
AISI 304
hochfestes Polyesterband

in aufhängbarer Verpackung

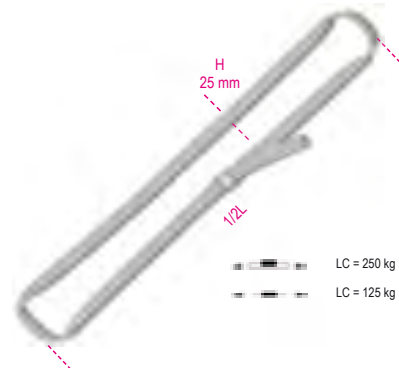

LC = 250 kg
LC = 125 kg

L m	H mm	€		
3	25	35,50	1	082970230

LC = 250 kg

HEBEBÄNDER

Sicherheitsfaktor 7:1
Herstellerbescheinigung
gefertigt nach UNI EN 1492

TECHNISCHE DATEN

• Mindest-Sicherheitskoeffizient: 7

• Herstellungsnummer

LABORANALYSEN

• Zerreißprobe

VERFÜGBARE ZERTIFIKATIONEN

• Produktspezifikation

• Abnahmeprüfzeugnis Typ 2.2 UNI EN10204

• Herstellerzertifikat UNI EN1492

• CE-Konformitätserklärung

	1t	2t	3t	4t	5t
1t	0,8t	2t	1,4t	1t	
2t	1,6t	4t	2,8t	2t	
3t	2,4t	6t	4,2t	3t	
4t	3,2t	8t	5,6t	4t	
5t	4t	10t	7t	5t	
6t	4,8t	12t	8,4t	6t	
8t	6,4t	16t	11,2t	8t	
10t	8t	20t	14t	10t	
12t	9,6t	24t	16,8t	12t	
15t	12t	30t	21t	15t	
20t	16t	40t	28t	20t	
25t	20t	50t	35t	25t	
30t	24t	60t	42t	30t	
40t	32t	80t	56t	40t	
50t	40t	100t	70t	50t	

8150

Hebebänder, 1t, veilchenfarben, doppellagig,
verstärkte Längslöcher, aus hochfestem
Polyester (PES)

CE



EN 1492-1

L m	H mm	WLL ton	€		
0,5	30	1	5,40	1	081500005
1	30	1	6,80	1	081500010
1,5	30	1	8,60	1	081500015
2	30	1	9,60	1	081500020
2,5	30	1	11,00	1	081500025
3	30	1	12,10	1	081500030
3,5	30	1	13,50	1	081500035
4	30	1	15,60	1	081500040
5	30	1	18,40	1	081500050
6	30	1	21,00	1	081500060
8	30	1	27,50	1	081500080



8153

Hebebänder, 2t, grün, doppellagig, verstärkte Längslöcher, aus hochfestem Polyester (PES)

CE



EN 1492-1

L m	H mm	WLL ton	€	📄	📦
1	60	2	10,70	1	081530010
1,5	60	2	14,30	1	081530015
2	60	2	16,40	1	081530020
2,5	60	2	19,30	1	081530025
3	60	2	22,40	1	081530030
3,5	60	2	26,00	1	081530035
4	60	2	27,50	1	081530040
5	60	2	33,50	1	081530050
6	60	2	44,00	1	081530060
8	60	2	50,00	1	081530080
10	60	2	61,00	1	081530100

8156

Hebebänder, 3t, gelb, doppellagig, verstärkte Längslöcher, aus hochfestem Polyester (PES)

CE



EN 1492-1

L m	H mm	WLL ton	€	📄	📦
1	90	3	15,10	1	081560010
1,5	90	3	19,90	1	081560015
2	90	3	24,50	1	081560020
2,5	90	3	29,00	1	081560025
3	90	3	34,00	1	081560030
3,5	90	3	38,00	1	081560035
4	90	3	42,00	1	081560040
5	90	3	50,50	1	081560050
6	90	3	59,00	1	081560060
8	90	3	77,50	1	081560080
10	90	3	95,00	1	081560100
12	90	3	119,00	1	081560120

8157

Hebebänder, 4t, grau, doppellagig, verstärkte Längslöcher, aus hochfestem Polyester (PES)

CE



EN 1492-1

L m	H mm	WLL ton	€	📄	📦
2	120	4	33,50	1	081570020
3	120	4	44,50	1	081570030
4	120	4	57,50	1	081570040
5	120	4	70,00	1	081570050
6	120	4	81,00	1	081570060
8	120	4	105,50	1	081570080
10	120	4	129,00	1	081570100
12	120	4	163,00	1	081570120

8158

Hebebänder, 5t, rot, doppellagig, verstärkte Längslöcher, aus hochfestem Polyester (PES)

CE



EN 1492-1

L m	H mm	WLL ton	€	📄	📦
2	150	5	46,50	1	081580020
3	150	5	70,00	1	081580030
4	150	5	77,50	1	081580040
5	150	5	93,50	1	081580050
6	150	5	111,00	1	081580060
8	150	5	143,00	1	081580080
10	150	5	175,00	1	081580100
12	150	5	221,00	1	081580120



8159

Hebebänder, 6t, braun, doppellagig, verstärkte Längslöcher, aus hochfestem Polyester (PES)

CE



EN 1492-1

L m	H mm	WLL ton	€	📄	📦
2	180	6	57,50	1	081590020
3	180	6	85,00	1	081590030
4	180	6	109,50	1	081590040
5	180	6	131,50	1	081590050
6	180	6	153,50	1	081590060
8	180	6	201,00	1	081590080
10	180	6	248,00	1	081590100

8160

Hebebänder, 8t, blau, doppellagig, verstärkte Längslöcher, aus hochfestem Polyester (PES)

CE



EN 1492-1

L m	H mm	WLL ton	€	📄	📦
3	240	8	116,50	1	081600030
4	240	8	148,50	1	081600040
5	240	8	176,50	1	081600050
6	240	8	210,00	1	081600060
8	240	8	270,00	1	081600080
10	240	8	336,00	1	081600100

8161

Hebebänder, orangefarben,
10 t doppelartig, flach
20 t vierlagig, flach
verstärkte Längslöcher

CE



EN 1492-1

L m	H mm	WLL ton	€	U	U
3	300	10	161,00	1	081610030
4	300	10	237,00	1	081610040
5	300	10	284,00	1	081610050
6	300	10	330,00	1	081610060
8	300	10	436,00	1	081610080
10	300	10	531,00	1	081610100
12	300	10	638,00	1	081610120
3	300	20	525,00	1	081612030
4	300	20	659,00	1	081612040
5	300	20	794,00	1	081612050
6	300	20	928,00	1	081612060
8	300	20	1.196,00	1	081612080
10	300	20	1.465,00	1	081612100
12	300	20	1.735,00	1	081612120

8170

Rundschlingen, 1t, veilchenfarben, aus
hochfestem Polyester (PES)

CE

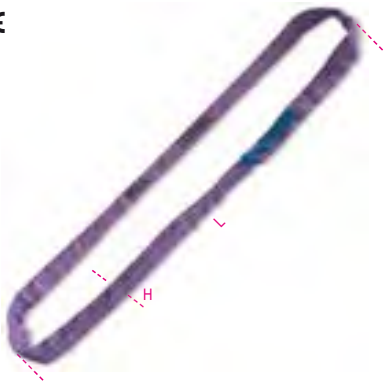

EN 1492-2

L m	WLL ton	H mm	€	U	U
0,5	1	45	6,10	1	081700010
1	1	45	8,00	1	081700020
1,5	1	45	11,20	1	081700030
2	1	45	14,50	1	081700040
2,5	1	45	17,90	1	081700050
3	1	45	21,10	1	081700060
4	1	45	28,00	1	081700080
5	1	45	34,50	1	081700100

8173

Rundschlingen, 2t, grün, aus hochfestem
Polyester (PES)

CE

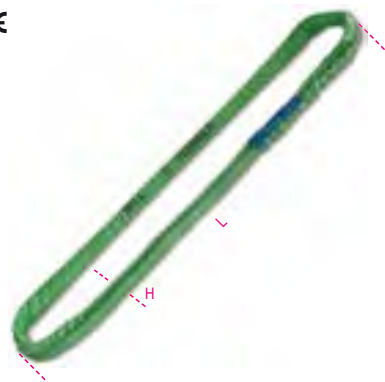

EN 1492-2

L m	H mm	WLL ton	€	U	U
0,5	50	2	8,00	1	081730010
1	50	2	12,10	1	081730020
1,5	50	2	17,60	1	081730030
2	50	2	23,10	1	081730040
2,5	50	2	28,50	1	081730050
3	50	2	33,50	1	081730060
4	50	2	45,50	1	081730080
5	50	2	56,50	1	081730100
6	50	2	67,50	1	081730120
8	50	2	88,50	1	081730160

8176

Rundschlingen, 3t, gelb, aus hochfestem
Polyester (PES)

CE



EN 1492-2

L m	H mm	WLL ton	€	U	U
0,5	60	3	8,80	1	081760010
1	60	3	15,90	1	081760020
1,5	60	3	23,10	1	081760030
2	60	3	29,50	1	081760040
2,5	60	3	37,50	1	081760050
3	60	3	44,50	1	081760060
4	60	3	59,50	1	081760080
5	60	3	74,00	1	081760100
6	60	3	89,50	1	081760120
8	60	3	118,00	1	081760160

8177

Rundschlingen, 4t, grau, aus hochfestem
Polyester (PES)

CE



EN 1492-2

L m	H mm	WLL ton	€	U	U
0,5	65	4	17,50	1	081770010
1	65	4	18,80	1	081770020
1,5	65	4	28,00	1	081770030
2	65	4	37,00	1	081770040
2,5	65	4	47,00	1	081770050
3	65	4	55,00	1	081770060
4	65	4	71,50	1	081770080
5	65	4	89,50	1	081770100
6	65	4	107,00	1	081770120
8	65	4	143,00	1	081770160

8178

Rundschlingen, 5t, rot, aus hochfestem
Polyester (PES)

CE

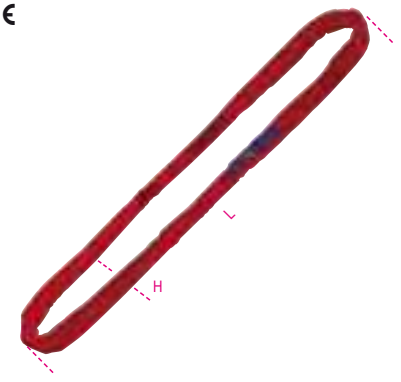

EN 1492-2

L m	H mm	WLL ton	€	U	U
0,5	70	5	23,30	1	081780010
1	70	5	27,50	1	081780020
1,5	70	5	34,50	1	081780030
2	70	5	46,50	1	081780040
2,5	70	5	56,00	1	081780050
3	70	5	66,50	1	081780060
4	70	5	88,50	1	081780080
5	70	5	111,00	1	081780100
6	70	5	132,00	1	081780120
8	70	5	177,00	1	081780160

8179M

Rundschlingen, 6t, braun, aus hochfestem Polyester (PES)

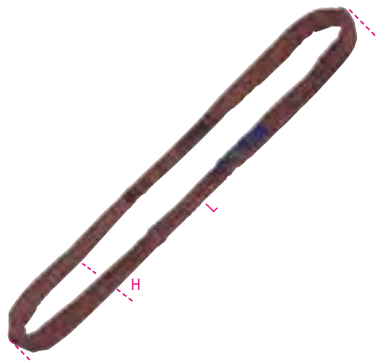

EN 1492-2

L m	H mm	WLL ton	€		
1	80	6	29,50	1	081790020
1,5	80	6	43,00	1	081790030
2	80	6	56,50	1	081790040
2,5	80	6	70,00	1	081790050
3	80	6	80,50	1	081790060
4	80	6	109,00	1	081790080
5	80	6	138,00	1	081790100
6	80	6	162,50	1	081790120
8	80	6	216,50	1	081790160

8179B

Rundschlingen, 8 t, blau, aus hochfestem Polyester (PES)



EN 1492-2

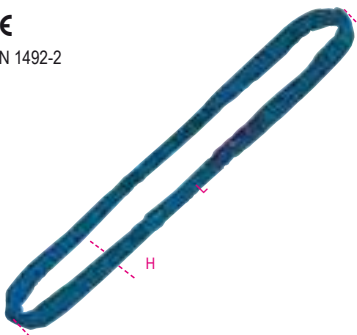

L m	H mm	WLL ton	€		
1	85	8	37,50	1	081790220
1,5	85	8	56,50	1	081790230
2	85	8	75,50	1	081790240
2,5	85	8	93,50	1	081790250
3	85	8	109,00	1	081790260
4	85	8	144,00	1	081790280
5	85	8	186,00	1	081790300
6	85	8	217,00	1	081790320
8	85	8	288,00	1	081790360

8179A

Rundschlingen, 10t=50t, orangefarbig, aus hochfestem Polyester (PES)



EN 1492-2

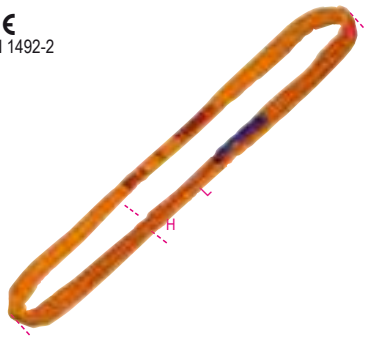

L m	H mm	WLL ton	€		
1	95	10	56,50	1	081790502
1,5	95	10	77,50	1	081790503
2	95	10	111,00	1	081790504
2,5	95	10	129,00	1	081790505
3	95	10	170,00	1	081790506
4	95	10	222,00	1	081790508
5	95	10	249,00	1	081790510
6	95	10	329,00	1	081790512
8	95	10	402,00	1	081790516
10	95	10	552,00	1	081790520
12	95	10	587,00	1	081790524
2	100	12	172,00	1	081791204
2,5	100	12	203,00	1	081791205
3	100	12	233,00	1	081791206
3,5	100	12	264,00	1	081791207
4	100	12	295,00	1	081791208
4,5	100	12	298,00	1	081791209
5	100	12	358,00	1	081791210
5,5	100	12	389,00	1	081791211
6	100	12	419,00	1	081791212
6,5	100	12	450,00	1	081791213
7	100	12	482,00	1	081791214
7,5	100	12	512,00	1	081791215
8	100	12	542,00	1	081791216
8,5	100	12	574,00	1	081791217
9	100	12	606,00	1	081791218
9,5	100	12	637,00	1	081791219
10	100	12	667,00	1	081791220
2	110	15	212,00	1	081791504
2,5	110	15	249,00	1	081791505
3	110	15	283,00	1	081791506
3,5	110	15	320,00	1	081791507
4	110	15	378,00	1	081791508
4,5	110	15	390,00	1	081791509
5	110	15	425,00	1	081791510
5,5	110	15	462,00	1	081791511
6	110	15	497,00	1	081791512
6,5	110	15	534,00	1	081791513
7	110	15	569,00	1	081791514
7,5	110	15	604,00	1	081791515
8	110	15	640,00	1	081791516
8,5	110	15	677,00	1	081791517
9	110	15	712,00	1	081791518
9,5	110	15	755,00	1	081791519
10	110	15	782,00	1	081791520
2	130	20	249,00	1	081792004
2,5	130	20	293,00	1	081792005
3	130	20	337,00	1	081792006
3,5	130	20	379,00	1	081792007
4	130	20	424,00	1	081792008
4,5	130	20	466,00	1	081792009
5	130	20	510,00	1	081792010
5,5	130	20	552,00	1	081792011
6	130	20	596,00	1	081792012
6,5	130	20	638,00	1	081792013
7	130	20	681,00	1	081792014
7,5	130	20	724,00	1	081792015
8	130	20	906,00	1	081792016
8,5	130	20	813,00	1	081792017
9	130	20	855,00	1	081792018
9,5	130	20	899,00	1	081792019
10	130	20	942,00	1	081792020

2	135	25	276,00	1	081792504
2,5	135	25	330,00	1	081792505
3	135	25	384,00	1	081792506
3,5	135	25	437,00	1	081792507
4	135	25	493,00	1	081792508
4,5	135	25	547,00	1	081792509
5	135	25	601,00	1	081792510
5,5	135	25	655,00	1	081792511
6	135	25	710,00	1	081792512
6,5	135	25	764,00	1	081792513
7	135	25	819,00	1	081792514
7,5	135	25	872,00	1	081792515
8	135	25	926,00	1	081792516
8,5	135	25	981,00	1	081792517
9	135	25	1.034,00	1	081792518
9,5	135	25	1.087,00	1	081792519
10	135	25	1.141,00	1	081792520
2	160	30	324,00	1	081793004
2,5	160	30	390,00	1	081793005
3	160	30	457,00	1	081793006
3,5	160	30	522,00	1	081793007
4	160	30	589,00	1	081793008
4,5	160	30	655,00	1	081793009
5	160	30	721,00	1	081793010
5,5	160	30	788,00	1	081793011
6	160	30	852,00	1	081793012
6,5	160	30	918,00	1	081793013
7	160	30	983,00	1	081793014
7,5	160	30	1.050,00	1	081793015
8	160	30	1.114,00	1	081793016
8,5	160	30	1.182,00	1	081793017
9	160	30	1.245,00	1	081793018
9,5	160	30	1.315,00	1	081793019
10	160	30	1.380,00	1	081793020
2	165	40	451,00	1	081794004
2,5	165	40	504,00	1	081794005
3	165	40	584,00	1	081794006
3,5	165	40	669,00	1	081794007
4	165	40	752,00	1	081794008
4,5	165	40	832,00	1	081794009
5	165	40	916,00	1	081794010
5,5	165	40	999,00	1	081794011
6	165	40	1.081,00	1	081794012
6,5	165	40	1.165,00	1	081794013
7	165	40	1.240,00	1	081794014
7,5	165	40	1.330,00	1	081794015
8	165	40	1.405,00	1	081794016
8,5	165	40	1.495,00	1	081794017
9	165	40	1.580,00	1	081794018
9,5	165	40	1.655,00	1	081794019
10	165	40	1.740,00	1	081794020
3	180	50	678,00	1	081795006
3,5	180	50	774,00	1	081795007
4	180	50	869,00	1	081795008
4,5	180	50	962,00	1	081795009
5	180	50	1.058,00	1	081795010
5,5	180	50	1.152,00	1	081795011
6	180	50	1.240,00	1	081795012
6,5	180	50	1.340,00	1	081795013
7	180	50	1.430,00	1	081795014
7,5	180	50	1.525,00	1	081795015
8	180	50	1.620,00	1	081795016
8,5	180	50	1.825,00	1	081795017
9	180	50	1.800,00	1	081795018
9,5	180	50	1.905,00	1	081795019
10	180	50	1.995,00	1	081795020

8166

Abriebschutzummantelungen für Hebeschlingen, aus hochfestem Polyester (PES) mit Elastomer-Unterschicht



H mm	ø mm	L m	€	📄	📦
70	45	3	24,40	1	081660073
80	52	3	28,50	1	081660083
110	70	3	37,00	1	081660103
155	100	3	72,50	1	081660153
170	110	3	80,00	1	081660170
235	150	4	218,00	1	081660235

H mm	📄	📦	📄
70	8150	8170-8173	081660073
80	8153	8176	081660083
110	8153-8156	8177-8178	081660103
155	8157	8178-8179A 8179B-8179M	081660153
170	8158	-	081660170
235	8159	-	081660235

8090F

Verbindungsglieder für Schlingenseile aus Polyester, aus hochfestem legiertem Stahl

CE

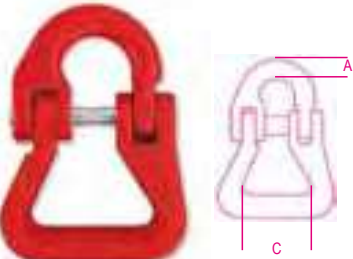

EN 1677-1

TECHNISCHE DATEN

- Mindest-Sicherheitskoeffizient: 4
- Wärmebehandlung: Vergütung
- Herstellungsnummer

LABORANALYSEN

- chemische Analyse, metallographische Analyse*
- Belastungstest (WLL x 2,5)
- Zerreißprobe

- Ermüdungstest (min. 20.000 Zyklen)

VERFÜGBARE ZERTIFIKATIONEN

- Produktspezifikation
- Abnahmeprüfzeugnis Typ 2.2 UNI EN10204
- Prüfbescheinigung Typ3.1 UNI EN10204
- CE-Konformitätserklärung

WLL kg	📄	A mm	C mm	€	📄	📦
2000	7-8	10,5	40	30,00	1	080900220
3150	10	12	50	37,50	1	080900232
5300	13	17	60	57,00	1	080900253
8000	16	21	75	87,50	1	080900280

ZURRGURTE

Koeffizient 2:1

gemäß der Norm UNI EN 12195

TECHNISCHE DATEN

- Mindest-Sicherheitskoeffizient: 2

- Identifizierungscode

LABORANALYSEN

- Vorspannungstest der Ratsche
- Verformungstest der Metallteilen
- Zerreißprobe des vollständigen Produktes

VERFÜGBARE ZERTIFIKATIONEN

- Produktspezifikation
- Abnahmeprüfzeugnis Typ 2.2 UNI EN10204

8180

Zurrgurte mit Ratsche, 1 Haken

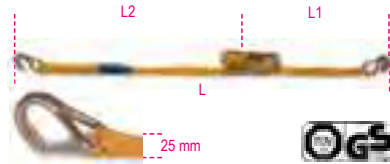

EN 12195-2

L m	L2 mm	L1 mm	STF daN	€	📄	📦
4	3750	250	200	14,20	1	081800004
6	5750	250	200	16,50	1	081800006
8	7750	250	200	18,40	1	081800008

LC = 750 kg

8181

Zurrgurte mit Ratsche, 1 Haken

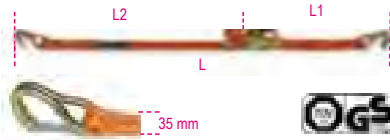

EN 12195-2

L m	L2 mm	L1 mm	STF daN	€	📄	📦
4	3600	400	180	17,50	1	081810004
6	5600	400	180	19,90	1	081810006
8	7600	400	180	21,80	1	081810008

LC = 1000 kg

8181 6/S4

Kit 4 Zurrgurte, LC 1000 kg, mit wasserfestem Polyester-Beutel

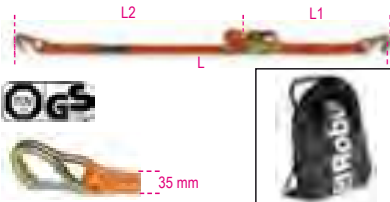

EN 12195-2

L mm	L1 mm	L2 mm	STF daN	€	📄	📦
6	400	5600	180	87,50	1	081810906

8181S

Zurrgurte mit Ratsche, LC 1000 kg, hochfestes Polyesterband (PES)

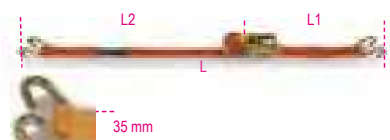

EN 12195-2

L m	L2 mm	L1 mm	STF daN	€	📄	📦
6	5600	400	180	19,40	1	081810206

LC = 1000 kg

8182E

Zurrgurte mit Ratsche für Innenraum von Transportwagen und Lastwagen, LC 1000 kg, hochfestes Polyesterband (PES)

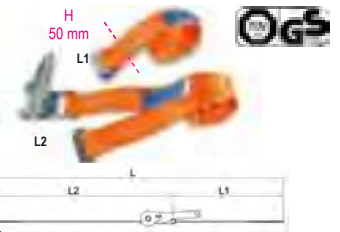

EN 12195-2

L m	L2 mm	L1 mm	STF daN	€	📄	📦
4	3500	500	220	19,90	1	081820440

LC = 1000 kg

	L2 mm	L1 mm	€	📄	📦
8182EL 2500	2500		6,30	1	081820942
8182EC 1500	1500		13,30	1	081820945

8182T

Zurrgurte mit Ratsche, 2 Haken, LC 1500 kg, hochfestes Polyesterband (PES)

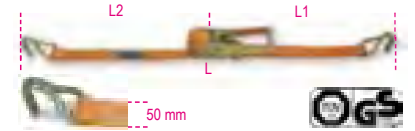

EN 12195-2

L m	L2 mm	L1 mm	STF daN	€	📄	📦
8,5	8100	400	300	35,50	1	081821085
10,5	10100	400	300	33,50	1	081821105

LC = 1500 kg

8182TS

Zurrgurte mit Ratsche, 1 Haken, LC 1500 kg, hochfestes Polyesterband (PES)

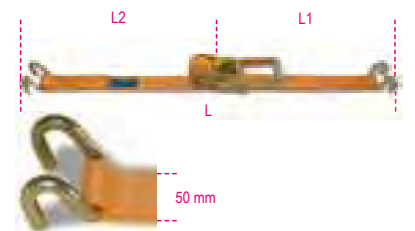

EN 12195-2

L m	L2 mm	L1 mm	STF daN	€	📄	📦
8,5	8100	400	300	36,50	1	081821285
10,5	10100	400	300	36,00	1	081821305

LC = 1500 kg

8182

Zurrgurte mit Ratsche, 1 Haken

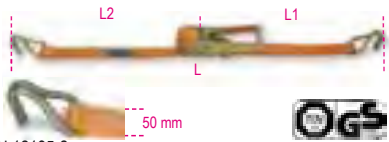

EN 12195-2

L m	L2 mm	L1 mm	STF daN	€		
4,5	4100	400	300	28,00	1	081820045
6,5	6100	400	300	32,50	1	081820065
8,5	8100	400	300	42,00	1	081820085
10,5	10100	400	300	40,50	1	081820105
14,5	14100	400	300	45,50	1	081820145
16,5	16100	400	300	52,00	1	081820165

LC = 2000 kg

	L2 mm	L1 mm	€		
8182LP 8100	8100		19,50	1	081820902
8182SP 400		400	19,90	1	081820905

8182 8,5/S2

Kit 2 Zurrgurte, LC 2000 kg,
mit wasserfestem Polyester-Beutel

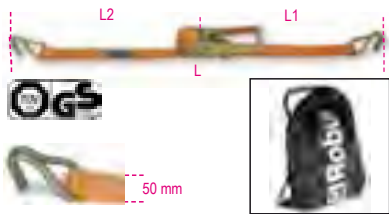

EN 12195-2

L mm	L1 mm	L2 mm	STF daN	€		
8,5	400	8100	300	79,00	1	081821985

8182S

Zurrgurte mit Ratsche, 2 Haken

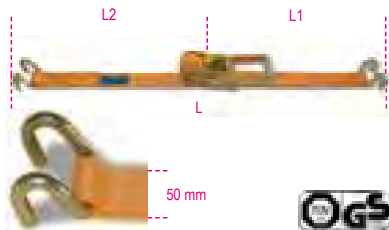

EN 12195-2

L m	L1 mm	L2 mm	STF daN	€		
6,5	400	6100	300	37,00	1	081820265
8,5	400	8100	300	36,50	1	081820285
10,5	400	10100	300	40,50	1	081820305

LC = 2000 kg

	L2 mm	L1 mm	€		
8182SLP 8100	8100	-	19,00	1	081820912
8182SSP 400		400	19,50	1	081820915

8182GD

Zurrgurte mit Ratsche, LC 2000 kg,
hochfestes Polyesterband (PES)
mit Delta-Haken



EN 12195-2

L m	L2 mm	L1 mm	STF daN	€		
8,5	8100	400	300	42,00	1	081820485

LC = 2000 kg

8182A

Zurrgurte mit Ratsche mit 2 Schlaufen, LC
2000 kg,
hochfestes Polyesterband (PES)



EN 12195-2

L m	L2 mm	L1 mm	STF daN	€		
8,5	8100	400	300	36,50	1	081820585

LC = 2000 kg

8182H

Zurrgurte mit Ratsche, 1 Haken, LC 2500 kg,
hochfestes Polyesterband (PES)

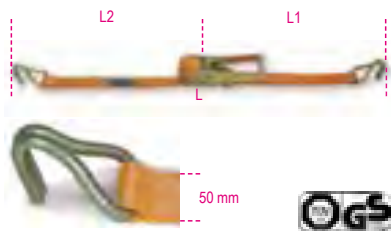

EN 12195-2

L m	L2 mm	L1 mm	STF daN	€		
6,5	6100	400	300	36,00	1	081820406
8,5	8100	400	300	38,50	1	081820408
10,5	10100	400	300	42,50	1	081820410
14,5	14100	400	300	54,00	1	081820414

LC = 2500 kg

8182H/2

Zurrgurte mit Ratsche, 2 Haken, LC 2500 kg,
hochfestes Polyesterband (PES)

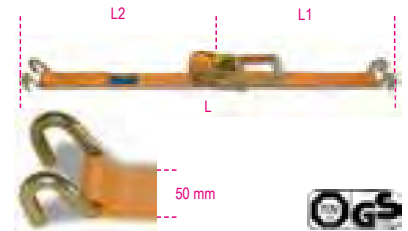

EN 12195-2

L m	L1 mm	L2 mm	STF daN	€		
8,5	8100	400	300	41,00	1	081820385

LC = 2500 kg

8184

Zurrgurte mit Langhebel-Umkerratsche, LC
2500 kg,
hochfestes Polyesterband (PES)
1 Haken



EN 12195-2

L m	L2 mm	L1 mm	STF daN	€		
6,5	6100	400	500	39,50	1	081840065
8,5	8100	400	500	41,50	1	081840085
10,5	10100	400	500	45,00	1	081840105

LC = 2500 kg

8183

Zurrgurte mit Ratsche, LC 5000 kg,
hochfestes Polyesterband (PES)
1 Haken



EN 12195-2

L m	L2 mm	L1 mm	STF daN	€		
8,5	8000	500	500	112,50	1	081830085
12,5	12000	500	500	133,50	1	081830125

LC = 5000 kg

Robur

8190

Zurrkette mit Ratschenspanner, 2 Lasthaken, Güteklasse 8



EN12195/3

TECHNISCHE DATEN

- Mindest-Sicherheitskoeffizient: 2
- Wärmebehandlung: Vergütung
- Herstellungsnummer

VERFÜGBARE ZERTIFIKATIONEN

- Produktspezifikation
- Abnahmeprüfzeugnis Typ 2.2 UNI EN10204
- Prüfbescheinigung Typ3.1 UNI EN10204

Ø mm	LC daN	Ø mm	LC daN	€	U	U
10	6300	8	4000	82,50	1	081900010
13	10000	-	-	129,00	1	081900013

* ACHTUNG: Das Produkt kann mit 8mm Kette mit entsprechender Reduzierung der Last verwendet werden (LC 4000daN)

8190B

Zurrketten



EN12195/3

TECHNISCHE DATEN

- Mindest-Sicherheitskoeffizient: 2
- Wärmebehandlung: Vergütung
- Serialidentifikationsplatte

ANLIEGENDE ZERTIFIKATIONEN

- Herstellerzertifikat
- VERFÜGBARE ZERTIFIKATIONEN
- Abnahmeprüfzeugnis Typ 2.2 UNI EN10204
- Produktspezifikation

Ø mm	LC daN	L m	L1 m	€	U	U
8	4000	3,5	3,30	203,00	1	081901308
10	6300	3,5	3,28	307,00	1	081901310
13	10000	3,5	3,23	450,00	1	081901313



8185

Zurrgurte mit Rundratsche



EN 12195-2

L m	STF daN	€	U	U
5	200	11,80	1	081850005
8	200	14,20	1	081850008

8186

Zurrgurte mit Rundratsche



EN 12195-2

L m	STF daN	€	U	U
5	180	14,20	1	081860005
8	180	18,20	1	081860008

8187

Zurrgurte mit Rundratsche



EN 12195-2

L m	STF daN	€	U	U
5	350	26,00	1	081870005
8	350	35,50	1	081870008

8188C

Zurrgurten mit Rundratsche, LC 750 kg, hoch festes Polypropylenband (PP)

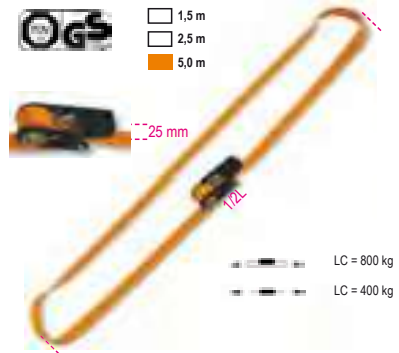

EN 12195-2

L m	STF daN	€	U	U
1,5	72	4,80	3	081880315
2,5	72	5,70	3	081880325
5	72	7,70	3	081880350

8188CG/25

Zurrgurten mit 2 Haken und Längslöchern, Rundratsche, LC 400 kg hoch festes Polyesterband (PES)



EN 12195-2

L m	L1 mm	L2 mm	STF daN	€	U	U
3	480	170	120	10,50	1	081880430
5	480	170	120	11,50	1	081880450

8188CU/25

Zurrgurte mit Zughaken,
Rundratsche LC 400kg
hochfestes Polyesterband (PES)



EN 12195-2

L	L1	L2	€	U	U
m	mm	mm			
5	300	4700	10,80	1	081880750

8188F

Klemmschnallen, LC 200 kg,
hoch festes Polypropylenband (PP)

- 1,5 m
- 2,0 m
- 2,5 m
- 3,0 m
- 5,0 m

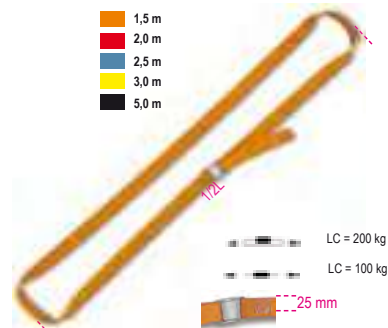

EN 12195-2

L	€	U	U
m			
1,5	2,80	10	081880215
2,0	3,00	10	081880220
2,5	3,30	10	081880225
3,0	3,80	10	081880230
5,0	4,50	6	081880250

8188F35

Klemmschnallen, LC 500 kg,
hochfestes Polypropylenband (PP)



EN 12195-2

L	€	U	U
m			
5	9,80	1	081880295

8188FG2

Klemmschnallen mit 2 Haken und
Längsöchern,
LC 250 kg
hoch festes Polypropylenband (PP)



EN 12195-2

L	L1	L2	€	U	U
m	mm	mm			
3	450	110	14,00	1	081881530

8188/K8

Kit Klemmschnallen
mit 8 Zubehörteilen



8188/K8	€	U	U
	41,00	1	081880801

8488K	0,65m - 7kg
8488K	0,80m - 7kg
8188CL	4m - 500kg
8188FP	2,5m - 250kg

8189

Polyesterband (PES)
für Zurrgurten mit Ratsche



H	L	LC	€	U	U
mm	m	kg			
25	100	750	95,00	1	081890902
35	100	1000	120,00	1	081890903
50	100	2000	191,50	1	081890905

8189A

Antirutschmatte für die Ladungssicherung



L m	H mm	S mm	μ	€	U	U
5	250	8	0,6	66,00	1	081890525

8189PA

2 Kantenschutz
für Polyester-Verankerungsbänder

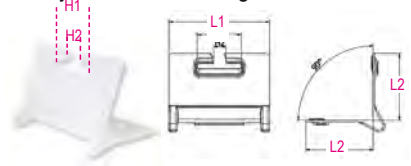

L1xL2	H1	H2	€	U	U
mm	mm	mm			
135x90	60	18	4,30	1	081890090

Robur

Artikel	Prüfbericht 2.2 (UNI EN 10204)	Kontrollzertifikat 3.1(UNI EN 10204)	Herstellerzertifikat	CE Konformitätserklärung
8001Z	✓	✓		✓
8001TZ	✓	✓		✓
8002ZD	✓			
8003ZD	✓			
8004ND	✓			
8005Z	✓			✓
8005TZ	✓			✓
8006Z	✓			✓
8007Z	✓			✓
8008N	✓			✓
8008TZN	✓			✓
8009FD	✓			
8009Z	✓			✓
8009TZ	✓			✓
8010Z	✓			✓
8010TZ	✓			✓
8011Z	✓			✓
8011TZ	✓			✓
8015	✓		✓	✓
8016	✓			✓
8016DA	✓			✓
8016FR	✓			
8016U2	✓		✓	✓
8016UGK	✓		✓	✓
8018E	✓			
8018T	✓			
8020A	✓			
8021A	✓			
8025	✓	✓		✓
8026A	✓	✓		✓
8026R	✓	✓		✓
8028	✓	✓		✓
8029R	✓	✓		✓
8031R	✓	✓		✓
8032	✓	✓		✓
8040EN	✓	✓		✓
8040EZ	✓	✓		✓
8042EN	✓	✓		✓
8042EZ	✓	✓		✓
8041	✓	✓		✓
8043	✓	✓		✓
8044	✓	✓		✓
8048	✓			
8049	✓	✓		✓
8049A	✓	✓		✓
8049V	✓	✓		✓
8051S	✓	✓		✓
8052	✓	✓		✓
8057R	✓	✓		✓
8058R	✓	✓		✓
8060R	✓	✓		✓
8061R	✓	✓		✓
8062	✓	✓		✓
8063	✓	✓		✓
8063SL	✓	✓		✓
8064S	✓	✓		✓
8065SC	✓	✓		✓
8068S	✓	✓		✓
8074	✓			
8074A	✓			
8074G	✓			
8080	✓			
8080FM	✓			
8085R	✓	✓		✓
8086	✓	✓		✓

Artikel	Prüfbericht 2.2 (UNI EN 10204)	Kontrollzertifikat 3.1(UNI EN 10204)	Herstellerzertifikat	CE Konformitätserklärung
8090	✓	✓		✓
8090F	✓	✓		✓
8090R	✓	✓		✓
8091			✓	✓
8091SL			✓	✓
8092			✓	✓
8092SL			✓	✓
8094			✓	✓
8094SL			✓	✓
8096			✓	✓
8096SL			✓	✓
8097			✓	✓
8097SL			✓	✓
8098			✓	✓
8098SL			✓	✓
8100	✓	✓		✓
8105	✓	✓		✓
8109	✓	✓		✓
8110	✓			
8114	✓			
8116	✓			
8120 - 8120D	✓			
8120B	✓			
8121MZC	✓			
8134	✓		✓	✓
8135	✓		✓	✓
8143	✓		✓	✓
8146	✓		✓	✓
8146C	✓		✓	✓
8147C-S-P	✓		✓	✓
8148	✓		✓	✓
8149	✓		✓	✓
8150	✓		✓	✓
8153	✓		✓	✓
8156	✓		✓	✓
8157	✓		✓	✓
8158	✓		✓	✓
8159	✓		✓	✓
8160	✓		✓	✓
8161	✓		✓	✓
8166	✓			
8170	✓		✓	✓
8173	✓		✓	✓
8176	✓		✓	✓
8177	✓		✓	✓
8178	✓		✓	✓
8179M-B-A	✓		✓	✓
8180	✓			
8181	✓			
8181S	✓			
8182	✓			
8182A-GD	✓			
8182E	✓			
8182H-H2	✓			
8182M	✓			
8182S	✓			
8182T	✓			
8182T-TS	✓			
8182TS	✓			
8185	✓			
8186	✓			
8187	✓			
8188C	✓			
8188CG/25	✓			
8188CU	✓			

Artikel	Prüfbericht 2.2 (UNI EN 10204)	Kontrollzertifikat 3.1(UNI EN 10204)	Herstellerzertifikat	CE Konformitätserklärung
8188F	✓			
8188VF/35	✓			
8188FG2	✓			
8190	✓	✓		
8190B	✓		✓	
8302Z	✓			
8303Z	✓			
8317DZ	✓			
8317SZ	✓			
8381SL	✓			
8381SP	✓			
8383C	✓			
8383P	✓			
8515V	✓			
8515Z	✓			
8531	✓			
8532	✓			
8535	✓			
8201T	✓			
8205	✓			
8206	✓			
8207	✓			
8209	✓			
8210	✓			
8210F	✓			
8210FTP	✓			
8216	✓			✓
8220	✓			
8225	✓			
8227	✓			
8228	✓			
8240	✓			
8240F	✓	✓		✓
8242	✓			
8242F	✓	✓		✓
8248	✓			
8249	✓			
8249G	✓			
8250	✓			
8264	✓			
8267	✓			
8272	✓			
8273	✓			
8274	✓			
8274A	✓			
8274G	✓			
8276	✓			
8276G	✓			
8278	✓			
8280	✓			
8282	✓			
8282S	✓			
8284	✓			
8285	✓			
8286	✓			
8287	✓			
8290	✓			
8293	✓			
8297C	✓			
8297F	✓			
8381SX	✓			
8702...	✓	✓		
8709...	✓	✓		



Beta Collection



Eine Linie mit exklusiven Artikeln, in denen der Charakter von Beta zum Ausdruck kommt, mit über 200 Originalprodukten höchster Qualität, darunter Sportausrüstung, technische Bekleidung und viele personalisierte Geschenkartikel. Ideal für Werbekampagnen, Freizeit und Relax.

9500TL

Softshell-Jacke aus 100% Polyester, 320 g/m², 3-schichtig, Außenschale aus Mikrofaser, wasserabweisende und atmungsaktive Zwischenmembran, Innenteil aus Fleece



Größe	€	Stk	Art-Nr.
S	212,00	1	095000051
M	212,00	1	095000052
L	212,00	1	095000053
XL	212,00	1	095000054
XXL	212,00	1	095000055

9501TLD

Damen-Sweatshirt aus 80% Baumwolle, 20% Polyester, 320 g/m²



Größe	€	Stk	Art-Nr.
S	103,50	1	095010061
M	103,50	1	095010062
L	103,50	1	095010063
XL	103,50	1	095010064

9501TL

Männer-Sweatshirt aus 80% Baumwolle, 20% Polyester, 320 g/m²



Größe	€	Stk	Art-Nr.
S	121,00	1	095010051
M	121,00	1	095010052
L	121,00	1	095010053
XL	121,00	1	095010054
XXL	121,00	1	095010055

9502TL

Poloshirt aus 100% Baumwoll-Piqué, 210 g/m²



Größe	€	Stk	Art-Nr.
S	71,50	1	095020051
M	71,50	1	095020052
L	71,50	1	095020053
XL	71,50	1	095020054
XXL	71,50	1	095020055

9503TL

T-shirt aus 100% Baumwoll-Jersey, 160 g/m²



Größe	€	Stk	Art-Nr.
S	46,50	1	095030051
M	46,50	1	095030052
L	46,50	1	095030053
XL	46,50	1	095030054
XXL	46,50	1	095030055

9504TL

Stoffjacke, extern 100% Polyester mit wasserabweisender Imprägnierung



Größe	€	Stk	Art-Nr.
S	143,50	1	095040051
M	143,50	1	095040052
L	143,50	1	095040053
XL	143,50	1	095040054
XXL	143,50	1	095040055

9505TL

Stoffweste, extern 100% Polyester mit wasserabweisender Imprägnierung, Wattierung 150 g/m², und Innentasche



Größe	€	Stk	Art-Nr.
S	177,00	1	095050051
M	177,00	1	095050052
L	177,00	1	095050053
XL	177,00	1	095050054
XXL	177,00	1	095050055

9572LB

T-Shirt Beta-March, 100% Baumwolle, 200 g/m², orangefarben, mit schwarzen Einsätzen



Größe	€	Stk	Art-Nr.
S	56,00	1	095720801
M	56,00	1	095720802
L	56,00	1	095720803
XL	56,00	1	095720804
XXL	56,00	1	095720805

9510W

Stretch-Herrenhemd, Langarm, 120 g/m², 97% Baumwolle, 3% Elastan. Weiß, mit schwarzem Logo. Rückenpasse mit zwei Seitenfalten, halbfranzösischer Kragen. Weiße Knöpfe, zwei Manschettenknöpfe. Slim Fit



Größe	€	Stk	Art-Nr.
XS	130,00	1	095100100
S	130,00	1	095100101
M	130,00	1	095100102
L	130,00	1	095100103
XL	130,00	1	095100104
XXL	130,00	1	095100105

9534W0

Poloshirt, 2 Knöpfe, aus Baumwolljersey, 200 g/m², weiß, mit orangefarbenen Einsätzen



Größe	€	Stk	Art-Nr.
S	73,50	1	095340031
M	73,50	1	095340032
L	73,50	1	095340033
XL	73,50	1	095340034
XXL	73,50	1	095340035

9534B0

Poloshirt, 2 Knöpfe, aus Baumwolljersey, 200 g/m², blau, mit grauen Einsätzen



Größe	€	Stk	Art-Nr.
S	73,50	1	095340071
M	73,50	1	095340072
L	73,50	1	095340073
XL	73,50	1	095340074
XXL	73,50	1	095340075

9537TL

Fleece-Pullover aus 100% Polyester



Größe	€	Stk	Art-Nr.
S	70,00	1	095370051
M	70,00	1	095370052
L	70,00	1	095370053
XL	70,00	1	095370054
XXL	70,00	1	095370055



9580S
Sonnenbrille

CE



EN ISO 12312-1:2013+A1:2015
UV400
FILTER CAT. III

9580S € 39,00 1 095800100

9593S
Smartwatch, Touchscreen, Fitness-Tracker,
Silikonband



9593 S € 169,00 1 095930200

9593SB
Smart Bracelet, Touchscreen, Fitness-Tracker,
multifunktional, mit Herzfrequenzmesser,
Schrittzähler, Schlafmonitor, mit
Silikonarmband, schwarz

Kompatibilität: IOS 8.2 und höher / Android 4.4 und höher
Bluetooth 4.2
IP67

CE



IP67

9593SB € 124,00 1 095930205

9593M

Uhr mit automatischer Bewegung,
Stahlgehäuse, water resistant 5 ATM,
Stahlband



9593M € 409,00 1 095930120

9593A

Chronograph Uhr, Stahlgehäuse, wasserdicht
bis 5 ATM, Silikonband



9593A € 324,00 1 095930050

9593W

Analoguhr, Soft-Touch-Kunststoff-Gehäuse,
mit Metalllunette, wasserdicht bis 3 ATM,
Silikonband



9593W € 71,50 1 095930150



9544C

Trolley Bordgepäck mit 4 Rädern, TSA-
Schloss, USB-Port + Jack 3,5 mm



9544C L 40 cm S 20 cm H 55 cm € 169,00 1 095440101

9557J 2.0

Tasche aus Polyester beschichtet/Polyester
Oxford 600d , Abmessungen 47x28x25 cm



9557J 2.0 L 47 cm S 25 cm H 28 cm € 101,00 1 095570020

9541F

Rucksack aus Polyester beschichtet/Polyester Oxford 600d, Abmessungen 50x33x16 cm



9541F	L cm	S cm	H cm	€		
	33	16	50	94,50	1	095410011

9541PC

Mehrtaschen-Arbeitsrucksack, mit Computer-Innentasche, 100 % Polyester

- Rucksack mit 3 Fächern, alle mit wasserdichtem Außenreißverschluss
- erstes Fach mit PC-Tasche
- oberer Griff gepolstert
- USB-Buchse
- seitliche Netztasche für Wasserflasche/Regenschirm
- Brillenhalterinsatz am Schultergurt
- verstellbarer Brustgurt



9541PC	L cm	S cm	H cm	€		
	34	18	52	81,50	1	095410041

9541S

Rucksack mit Tunnelzug aus wasserdichtem Polyester 210D, 33x45 cm



9541S	L cm	H cm	€		
	33	45	12,80	1	095410031

9541BIKE

Rucksack aus Polyester Oxford, Abmessungen 41x24x16 cm



9541BIKE	L cm	S cm	H cm	€		
	24	16	41	22,40	1	095410021

95740

Arbeitshandschuhe, mit Stretch-Manschette, Daumen- und Zeigefingerverstärkung, aus Synthetikleder, Touchscreen-fähig

CE



	€		
M	43,50	1	095740202
L	43,50	1	095740203
XL	43,50	1	095740204
XXL	43,50	1	095740205

9574B

Arbeitshandschuhe, mit Stretch-Manschette, Daumen- und Zeigefingerverstärkung, aus Synthetikleder, Touchscreen-fähig

CE



	€		
M	43,50	1	095740102
L	43,50	1	095740103
XL	43,50	1	095740104
XXL	43,50	1	095740105

9525CM

Camouflage Racing Cap mit flachem Schirm, 100 % Polyester, rückseitige Öffnungen und Snapback



9525CM	€		
	28,00	1	095250098

9525TR

Trucker Cap, schwarz, mit gewölbtem Schirm, 50 % Baumwolle, 50 % Polyester, rückseitig Mesh und Snapback



9525TR	€		
	28,00	1	095250011

9525WB

Baseballkappe, weiß, mit gewölbtem Schild, 100 % Polyester, Öffnungen an der Kappe und Riemenverschluss



9525WB	€		
	20,00	1	095251032

9520P

Metallschirmständer, verzinkt, mit lasergeschnittenem Logo, Tropfenauffangwanne, schwarz



9520P	€		
	78,00	1	095200100

9521

Automatikschirm aus Nylon T210 mit Alustock, schwarz, 3 Schnitte



9521	€		
	35,50	1	095210000



95210B

Regenschirm aus Nylon 210T, Durchmesser 100 cm



95210B	100 cm	€ 39,50	1	095210021
--------	--------	---------	---	-----------

9599CB-N2

City Bike Atala®, Rahmen aus Hi-Ten Tig TKK 700c, 6-Gangschaltung Shimano® Tourney RD-TZ50, V-Brake®-Bremsen, 28" Alu-Felgen, mit Gepäckträger, Ständer und Klingel, mattschwarz



9599CB-N2	€ 749,00	1	095990031
-----------	----------	---	-----------



9599CB-WN

City Bike Atala®, Alu-Rahmen, 6-Gangschaltung-Shimano®, V-Brake®-Bremsen, 28" Alu-Felgen, grau

- Alu-Rahmen
- Gabel Hi-Ten Tig TKK 700c
- Gangschaltung Shimano Tourney RD-TZ50 6s
- V-brake-Alu-Bremsen
- 28" Alu-Felgen
- Farbe: grau



9599CB-WN	€ 749,00	1	095990024
-----------	----------	---	-----------

9598W-N

Mountainbike Whistle®, Alu-Rahmen, Gabel Suntour XCT30 29" 100 mm, 7-Gangschaltung Shimano RD-TX500, hydraulische Bremsen Shimano BR-M200 und 29" Alu-Felgen, leuchtorange/anthrazitgrau, matt



9598W M-N	€ 1.275,00	1	095980130
9598W L-N	€ 1.275,00	1	095980132

9598WHP-N

Mountainbike Whistle®, Alu-Rahmen, Gabel Suntour XCM PL 29" 100 mm mit Remote Lockout, 12-Gangschaltung Shimano XT RD-M8100 Shadow Plus, hydraulische Bremsen Shimano BL-MT201/BR-MT200 und 29" Alu-Felgen 29", weiß/rot, matt



9598WHP M-N	€ 2.395,00	1	095980140
9598WHP L-N	€ 2.395,00	1	095980142

9597TRIOWAY

TRIOWAY BY ATALA®

Unterstützendes Antriebssystem TRIOWAY by ATALA®, elektrisch und an den Rollstuhl REHA COMFORT (im Lieferumfang) anhängbar, Lithium-Batterie im Rahmen, Lenker mit Richtungs- und Geschwindigkeitssteuerung, integriertes Rollstuhlanhängsystem

CE



STRUKTUR

- System zum schnellen An- und Abkoppeln an den bzw. vom Rollstuhl mit Hebel
- Faltbarer Rahmen mit Doppelscharnier
- Höhenverstellbarer Lenker
- Scheibenbremse, 180 mm
- LED-Frontleuchte
- Vorderrad mit Gummireifen

LEISTUNGEN

- Einstellbare Geschwindigkeit bis zu maximal 15 km/h
- Taste für Vorwärts- und Rückwärtsgang
- Reichweite: 20 km
- Hebelbeschleuniger am Lenker

AKKU

- Wiederaufladbarer Lithium-Akku 7 Ah
- Akku im Rahmen, herausnehmbar
- Ladekabel 230 V 50 Hz, im Lieferumfang

ZUBEHÖR

- Multifunktionales Display mit Anzeige der verbleibenden Akkuleistung und des Ladestatus
- Glocke
- Richtungsanzeiger
- Handyhalter, im Lieferumfang
- Ein/Aus-Taste
- SYSTEM ZUM SCHNELLEN ANKOPPELN UNTER DEM ROLLSTUHL, bereits installiert
- ROLLSTUHL REHA COMFORT, im Lieferumfang
- Faltbarer Rahmen mit Doppelscharnier
- 24-Zoll-Laufräder aus vollem PU
- Ausziehbare Armlehnen
- Abnehmbare und verstellbare Fußstützen

auf Anfrage verfügbar



9597TRIOWAY

1 095970200



9539CB

Schutzhelm für Straßenfahrrad und Mountain Bike mit abnehmbarem Visier - verstellbare Größen



Größe	€	Stk	Artikel-Nr.
S-M	197,50	1	095390010
L-XL	197,50	1	095390011

9542M

Kurzarm-Trikot aus atmungsaktiver Mikrofaser, langer, verdeckter Reißverschluss, drei Taschen hinten (davon eine mit Reißverschluss), Silikongummi am Trikotsaum



Größe	€	Stk	Artikel-Nr.
S	141,00	1	095420051
M	141,00	1	095420052
L	141,00	1	095420053
XL	141,00	1	095420054
XXL	141,00	1	095420055
XXXL	141,00	1	095420056

9542C

Trägerhose aus Lycra, Silikongummi am Hosensaum, mit antibakteriellem, hoch atmungsaktivem Sitzeinsatz



Größe	€	Stk	Artikel-Nr.
S	134,50	1	095420061
M	134,50	1	095420062
L	134,50	1	095420063
XL	134,50	1	095420064
XXL	134,50	1	095420065
XXXL	134,50	1	095420066

9542GW

Winterjacke aus winddichtem und hoch atmungsaktivem Stoff und gerautem Gewebe; langer Reißverschluss, elastisches Gummiband in der Taille ohne Silikon; eng anliegende Manschette aus Lycra; Reflektoreinsätze hinten; 3 Außentaschen hinten, davon 1 mit Reißverschluss



Größe	€	Stk	Artikel-Nr.
S	243,50	1	095420101
M	243,50	1	095420102
L	243,50	1	095420103
XL	243,50	1	095420104
XXL	243,50	1	095420105
XXXL	243,50	1	095420106

9542G

Wintertrikot aus atmungsaktivem, innen aufgerautem Gewebe, langer Reißverschluss, drei Taschen hinten, Silikongummi am Trikotsaum



Größe	€	Stk	Artikel-Nr.
S	140,50	1	095420012
M	140,50	1	095420013
L	140,50	1	095420014
XL	140,50	1	095420015
XXL	140,50	1	095420016
XXXL	140,50	1	095420017



9542S

Winter-Funktionsstrumpfhose aus aufgerauter Lycra mit antibakteriellem, hoch atmungsaktivem Sitzeinsatz



Größe	€	Stk	Artikel-Nr.
S	188,50	1	095420022
M	188,50	1	095420023
L	188,50	1	095420024
XL	188,50	1	095420025
XXL	188,50	1	095420026
XXXL	188,50	1	095420027

9542AT

Windweste aus atmungsaktivem Kombigewebe, langer Reißverschluss



Größe	€	Stk	Artikel-Nr.
S	113,50	1	095420072
M	113,50	1	095420073
L	113,50	1	095420074
XL	113,50	1	095420075
XXL	113,50	1	095420076
XXXL	113,50	1	095420077

9542AL

Wasserabweisendes langärmeliges Wind-Cape aus atmungsaktivem Gewebe



	€		
S	180,50	1	095420042
M	180,50	1	095420043
L	180,50	1	095420044
XL	180,50	1	095420045
XXL	180,50	1	095420046
XXXL	180,50	1	095420047

9543C

Multifunktions-Schlauchschal, 100% Polyester-Mikrofaser, nahtlos



	L cm	H cm	€		
9543C	25	50	10,00	1	095430100

9523T

Thermosflasche aus Edelstahl, 500 ml, doppelwandige Technologie, Vakuum zwischen den Wänden, auslaufsicherer Deckel, orangefarben
• 24 Stunden kalt
• 12 Stunden heiß



EC1935/EC2023

	ml	L mm	€		
9523T	500	255	25,00	1	095230050

9528B

Wasserflasche aus Polyethylen, 500ml



	ml	€		
9528B	500	7,90	1	095280005

9597P

Säulenpumpe mit Manometer

- Adapter für alle Typen von Fahrradschlauchventilen (Schrader, Presta/Scloverand, Regina)
- Max. 12 bar/ 180 psi



	€		
9597P	72,50	1	095970100

9524SC

Garage Beta in Miniatur für Sammler



	€		
1:18	103,50	1	095240018

9548KB

Balance-Bike, Alu-Rahmen und Rad 12" mit Luftkammer, empfohlenes Alter: + 3 Jahre, max. Gewicht <30 kg



	€		
9548KB	188,00	1	095480110

9548KB 20

Kinder-Mountainbike Atala® 20", Stahlrahmen Hi-Ten Tig 20", Federgabel 30 mm, 6-Gangschaltung Shimano Tourney RD-TY21SS, Alu-V-Brake-Bremsen und 36-Loch Alu-Felgen, leuchtgelb/mattblau



	€		
9548KB 20	605,00	1	095480120

9548KB 24

Kinder-Mountainbike Atala® 24", Stahlrahmen Hi-Ten Tig 24", Federgabel, 6-Gangschaltung Tourney RD-TY250, Alu-V-Brake-Bremsen und 36-Loch Alu-Felgen leuchtorangefarben, matt



	€		
9548KB 24	643,00	1	095480122

9547WSK

„Kinder Work Station“, Werkbank mit Werkzeugen für Kinder ab 3 Jahre

CE



	H cm	€		
9547WSK	74	141,00	1	095473801

9547T

„Kinder trolley“, Werkzeugwagen mit Werkzeugen für Kinder ab 3 Jahren

CE



	€		
9547T	76,00	1	095470100



9548G

"Kinder Garage", 6-stöckig, mit
Autowaschanlage, Lift und Rampen



9548 G	H cm	69	€	76,00	1	095480100
--------	---------	----	---	-------	---	-----------

9561V 2,5

Segelfahne, 2,5x0,50 m, mit Stange aus
Aluminium und Kreuzfuß-Sockel und
Ballastsack



9561V 2,5	L mt	0,50	H mt	2,5	€	275,00	1	095610200
-----------	---------	------	---------	-----	---	--------	---	-----------

9561VV 2,5

Segelfahne, 2x0,50 m,
mit Stange



9561VV 2,5	L mt	0,50	H mt	2,5	€	246,50	1	095610201
------------	---------	------	---------	-----	---	--------	---	-----------

9561VV

Segelfahne, 3,50x0,75 m,
mit Stange



9561VV 4,0	L mt	0,75	H mt	3,50	€	407,00	1	095610101
------------	---------	------	---------	------	---	--------	---	-----------

9561V

Segelfahne, 4x0,75 m
mit Stange aus verchromtem Metall,
Socket aus Zementkies, 50 cm



9561V	L mt	0,75	H mt	4	€	710,00	1	095610001
-------	---------	------	---------	---	---	--------	---	-----------

9559

Einseitiges Banner aus TNT, Modul 3x0,8 m



9559	L m	3	H m	0,8	€	33,00	1	095591001
------	--------	---	--------	-----	---	-------	---	-----------

9559/30MT

Rolle 10 Beta-Logos aus TNT



9559/30MT	€	311,00	1	095591031
-----------	---	--------	---	-----------

9590B

Flagge aus Nylon mit Siebdruck
40 x 215 cm



9590B	L cm	215	H cm	140	€	141,00	1	095900000
-------	---------	-----	---------	-----	---	--------	---	-----------



9577R

Arbeitsoverall im Rennsport-Stil aus 4-Wege-
Stretchgewebe, 260 g/m²,
schwarz und orange, mit weißen und
reflektierenden Einsätzen

CE



Größe	I	€	1	095770151
S	48	167,00	1	095770151
M	50	167,00	1	095770152
L	52	167,00	1	095770153
XL	54	167,00	1	095770154
XXL	56	167,00	1	095770155
XXXL	58	167,00	1	095770156

9579C

Hemd aus Polyester/Baumwolle



Größe	€	1	095791002
M	73,50	1	095791002
L	73,50	1	095791003
XL	73,50	1	095791004

9565T

Tisch-Stahlblechtonne mit Ablage aus lackiertem Mehrschicht-Birkenholz
 Geliefert mit doppeltem KIT Abstandsrohre (7 cm oder 20 cm) zur gewünschten Höheneinstellung.



9565T	H cm	ø cm	€		
	95→108	70	549,00	1	095650200

9565S

Stahlblechtonne mit Sitz aus abziehbarem Ökoleder



9565S	H cm	ø cm	€		
	60	38	240,50	1	095650300

9565K

Tonnetisch mit 2 Sitzplätzen



9565K	€		
	1.030,00	1	095650500



9563G

Bürosessel für Gäste



9563G	€		
	204,50	1	095630050

9563U

Ergonomischer Bürosessel mit Armlehnen



9563U	€		
	403,00	1	095630020

9549ABW

Kabellose BT V5.0 In-Ear-Kopfhörer, mit integriertem Mikrophon, magnetische Aufladung, Ladestation mit USB-C Anschluss, schwarz

CE



9549ABW	L mm	H mm	S mm	€		
	61	34,5	41	37,00	1	095490091

9549SBW

Kabelloser BT-Lautsprecher, tragbar, 6

Funktionen

BT 5.0-Version

FUNKTIONEN:

- BT-Wiedergabe
- TF Card Play
- USB Play
- Audiobuchse 3,5 mm
- FM-Radio
- Anruffunktion

CE



9549SBW	L mm	S mm	H mm	€		
	73	73	124	51,00	1	095490072

9549BP

Tragbare Batterie, 10000mAh



9549BP	€		
	26,50	1	095490052

9549CR

Mehrfachladekabel 4 in 1, aus geflochtenem Nylon, mit Schnellladung

• USB-Typ-A für Anschluss an das Netzteil

• Lightning für Anschluss an Apple-Modelle

• Micro-USB-Ladesteckverbinder

• USB-C-Steckverbinder nur zum Laden

• USB-C-Steckverbinder zum Laden und zur Datenübertragung



9549CR	L mm	€		
	120	19,70	1	095490042

9549MPC

Multi-Ladestation, 6 USB-Anschlüsse für Mehrfachaufladung bis zu einer maximalen Leistungsaufnahme von 65 W

• 4 USB-Anschlüsse, 5 V 2,4 A

• 1 USB-Anschluss, Q.C 3.0

• 1 USB-C-Anschluss, 20 W PD

mit separatem ON/OFF-Schalter

mit LED-Anzeige zur Überprüfung des Gesamtpotenzials, der Anschlusszahl und der Stromstärke

CE



9549MPC	L mm	S mm	H mm	€		
	110	72	35	62,50	1	095490082



9549BRW

Kabellose Ladestation mit Schnellladefunktion und Ladestatusanzeige

- Inklusive Kabel USB und USB-Typ-C zum Anschluss an den Transformator, Länge 1 m
- Kompatibel mit allen wireless-ladefähigen Geräten
- Input: DC 5 V/2 A, 9 V/2 A, 12 V/1,5 A
- Output: 5 W/7,5 W/10 W/15 W

CE



9549BRW	Ø mm	H mm	€	1	095490100
	58	6	35,50		

9549C

USB-Speicherstick, 32 GB



9549C	€	1	095490062
	23,20		

9547

Tischrechner

CE



9547	€	1	095470000
	23,30		

9594

Wanduhr mit Thermometer und Luftfeuchtigkeitsmesser, Durchmesser 26 cm



9594	Ø cm	€	1	095940051
	26	34,50		

9526F

Mini-Kühlschrank, Energieeffizienzklasse F, 63 Liter Inhalt, schwarz

CE



9526F	€	1	095260005
	608,00		

9526P

Espressokaffee kapselmaschine

Kompatibel mit Kaffeepads Lavazza™, Espresso Point™ gewerbliche Nutzung



9526P	€	1	095260010
	396,00		

9527 6T

Kaffeetassen-Set, 6 Tassen



9527 6T	€	1	095270001
	113,50		

9522A

Flaschenöffner mit ergonomischem Griff



9522A	€	1	095220010
	19,80		

9523A

Alu-Wasserflasche, 500ml



9523A	ml	€	1	095230005
	500	13,70		

9586K

Taschenmesser aus Edelstahl, mit 10 Funktionen



9586K	€	1	095860100
	19,00		

9526RMN

Satz 2 Kartenspiele je 55 Rommé Spielkarten Modiano®



9526RMN	€	1	095260001
	33,00		

9592B/C50

Set 50 Kugelschreiber



9592B/C50	€	1	095920050
	56,50		

9592B/P

Personalisierte Kugelschreiber



9592B/P	€	500	095920051
	1,70		

9592MB

Parker® Kugelschreiber



9592MB	€	1	095920060
	91,50		



9592M/50

Set 50 Stifte



9592M/50 € 56,50 1 095920100

9588M

Schaumeinsatz mit 1 Kugelschreiber und 2 Notizblöcken



9588M € 24,00 1 095880011

9596

Badge-Holder mit Karabinerhaken aus Metall und Umhängeband für Handys



9596 € 5,80 10 095961001

9595C

Schlüsselanhänger aus Leder



9595C € 10,40 1 095950011



9595T

Schlüsselanhänger aus verchromtem Metall, in Samttasche



9595T € 8,80 1 095950021

9569P

Einkaufstüte aus Polyethylen, mit seitlichen Falten



9569P L cm 34 H cm 44 € 1,10 50 095691001

9569S

Shopper aus TNT mit Falte, 38x42 cm



9569S L cm 38 H cm 42 € 2,90 50 095690051

9569MS-2

Shopper aus hochfestem Polypropylen



9569MS-2 L cm 45 H cm 40 € 7,60 5 095690055

9569MS

Shopper aus hochfestem Polypropylen, mit Doppelgriffen



9569MS L cm 60 H cm 40 € 7,60 5 095690052

9587 9x14

Notizbuch, 9x14 cm



9587 9X14 L cm 9 H cm 14 € 15,40 5 095870009

9587 13x21

Notizbuch, 13x21 cm



9587 13X21 L cm 13 H cm 21 € 19,70 5 095870013



9588S/10...

Satz an 10 Notizblöcken



9588S/10A 21x29 cm	€ 33,00	1	095881001
9588S/10B 15x21 cm	€ 32,00	1	095881002
9588S/10C 10x15 cm	€ 20,40	1	095881003
9588S/10D 7,5x10,5 cm	€ 14,70	1	095880054

9588/10PI

Satz an 10 Notizblöcken mit Haftblättern



9588S/10PI 7,5x7,5 cm	€ 31,00	1	095880055
--------------------------	---------	---	-----------

9589A/36

Packung mit 36 Rollen Paketklebeband, mit Beta Logo, havannabraun



9589A/36	€ 159,00	1	095890035
----------	----------	---	-----------

9589B/36

Packung mit 36 Rollen Paketklebeband, mit Beta Logo, weiß



9589B/36	€ 159,00	1	095890036
----------	----------	---	-----------

9562TB

Schuhprobe-Teppich, mit Rückseite aus rutschfestem Gummi



9562TB	L mm 800	H mm 600	€ 54,50	1	095620500
--------	----------	----------	---------	---	-----------

9562T2

Teppich für Werkbank 200x160 cm

- Schützt den Boden vor Öl- und Benzinleckagen und schützt die Umwelt
- Leicht zu säubern, Bodenseite aus Gummi und rutschfest



9562T2	L cm 200	H cm 160	€ 271,00	1	095620200
--------	----------	----------	----------	---	-----------

9562T1

Werkstatteppich, 100X80 cm

- Besonders geeignet für die Nutzung unter Motorrad-Reifenhebern BETA Art. 3071 und Art. 3071B
- Leicht zu säubern, Bodenseite aus Gummi, rutschfest



9562T1	L cm 100	H cm 80	€ 100,00	1	095620150
--------	----------	---------	----------	---	-----------

9562T3

Werkstatteppich
Abmessungen: 300x160 cm

- Besonders geeignet für die Nutzung unter Motorradhebebühnen
- Schützt den Boden vor Öl- und Benzinleckagen und schützt die Umwelt
- Leicht zu säubern, Bodenseite aus Gummi und rutschfest



9562T3	L cm 300	H cm 160	€ 396,00	1	095620300
--------	----------	----------	----------	---	-----------

9562P2

Logo-Teppich 200x80 cm

- Besonders geeignet für die Nutzung mit Werkstatteinrichtung C55 oder als Unterlagenteppich für Motorrad



9562P2	L cm 200	H cm 80	€ 190,50	1	095620400
--------	----------	---------	----------	---	-----------

9562P12

Multilogo Teppichrolle 12 m x 80 cm

- Ermöglicht, je nach Wunsch und Ansprüchen des Benutzers die Länge des Teppichs zu personalisieren



9562P12	L m 12	H cm 80	€ 962,00	1	095620425
---------	--------	---------	----------	---	-----------



PARTNERSHIP
2023



 **Beta**
AMBASSADOR

FABIO QUARTARARO
2023 MotoGP
World Championship

